

MINHIO[®]

MAQUINARIA INDUSTRIAL HOSTELERA S.L.U.



MAYO 2023 TOMO 1 NACIONAL

لوتس

RATIONAL

¿Quiénes somos?

MAINHO, Maquinaria Industrial Hostelera, S.L.U., es una empresa que inició sus actividades en 1981, con sede en Barcelona. Su vocación fue, desde el principio, la fabricación de máquinas destinadas a la hostelería.

El éxito de sus productos dio lugar a una continua expansión que llevaron en 1992 a ampliar las instalaciones de la empresa, desplazándose al Polígono Industrial «Can Galobardes», de Canovelles, donde ha sido preciso, recientemente, realizar una nueva ampliación.

La incorporación de nuevos productos derivó su atención a la comercialización de productos más especializados. El crecimiento ha sido debido tanto a la calidad como al incremento de la gama de productos ofertados, que de ser exclusivamente destinados a la pequeña hostelería (snacks) han pasado a cubrir todas las necesidades hasta las más grandes y complejas instalaciones.

Este interés por satisfacer al máximo la demanda del mercado, fue el motivo del acuerdo con la firma italiana LOTUS para ofrecer sus productos a toda España con la máxima garantía y con el servicio más próximo.

La constante innovación, con el diseño y la fabricación de nuevas máquinas incorporando la más reciente tecnología, la calidad probada y el excelente servicio, han sido los factores determinantes de la satisfacción que siempre han demostrado los clientes.

MAINHO tiene numerosas delegaciones en toda España y, además, exporta a más de 40 países. Los industriales de la hostelería pueden visitar los stands y conocer de cerca los productos de MAINHO en las más importantes ferias especializadas de Europa.

*MAQUINARIA INDUSTRIAL HOSTELERA S.L.U. se reserva el derecho de modificar los precios y diseños de los productos sin previo aviso. ESTA TARIFA ANULA Y SUSTITUYE LAS ANTERIORES.

*Prohibida la reproducción total o parcial sin expresa autorización por escrito de la empresa.



About us

MAINHO, Maquinaria Industrial Hostelera, S.L.U., is a company that started its activities in 1981, with headquarters in Barcelona. Its vocation was, from the start, manufacturing machines intended for the hospitality industry.

The success of its products gave rise to a continuous expansion that led the company to expand its facilities in 1992, moving to the "Can Galobardes" Industrial Estate, in Canovelles, where it has been necessary, recently, to make a new expansion.

The incorporation of new products derived its attention to marketing more specialised products. Growth has been due to both quality and increasing the range of products offered, which from being exclusively aimed at small scale hospitality (snacks) now cover all needs including the largest and most complex installations.

This interest to fully respond to market demands was behind the agreement with the Italian company LOTUS to offer its products to the whole of Spain with the maximum guarantee and with the most local service.

Constant innovation, with design and manufacture of new machines incorporating the latest technology, proven quality and excellent service, have been the determinants of the satisfaction always shown by the customers.

MAINHO has numerous delegations throughout Spain and, in addition, exports to more than 40 countries. Hospitality industrialists can visit the stands and learn about MAINHO's products in the most important specialised fairs in Europe.

*MAQUINARIA INDUSTRIAL HOSTELERA S.L.U. reserves the right to modify the prices and designs of its products without prior notice. THIS PRICE CANCELS AND REPLACES THE PREVIOUS ONES.

*Total or partial reproduction forbidden without the express written consent of the Company.



Tarifa n° 35
Tariff number 35

Garantía

Warranty

La garantía es de un año a partir de la fecha de facturación y cubre las partes defectuosas, cuya sustitución y transporte serán a cargo del comprador.

La garantía no cubre las partes eléctricas, ni los accesorios, ni ningún otro componente separable. Eventuales daños debidos al transporte o a la incorrecta instalación ó mantenimiento no se considerarán motivos válidos a los efectos de la garantía. El mantenimiento ordinario y las reparaciones por causas debidas a una incorrecta instalación no están cubiertas por la garantía. La garantía es válida solamente respecto al primer comprador y no contempla la sustitución del aparato.

MAINHO podrá efectuar las reparaciones en la sede del cliente o en la fábrica, según su propio criterio. Todos los gastos de transporte de la pieza o de los equipos que sea necesario cambiar o reparar correrán a cargo del cliente. El material enviado para su reparación deberá ir acompañado necesariamente por albarán de devolución debidamente cumplimentado especificando las incidencias. Caso de que se reciba el albarán de devolución inexacto, quedará anulada la garantía.

MAINHO no responde de los posibles retrasos que tengan lugar durante el periodo de la garantía y no indemniza ningún daño, directo o indirecto, consiguiente a las imperfecciones o defectos de la maquinaria suministrada, amparándose en el Código Civil.

Los posibles retrasos en la prestación del servicio no darán en ningún modo derecho al aplazamiento de los pagos relacionados con los equipos sujetos a la garantía. El retraso de los pagos, o la insolvencia incluso parcial del cliente, comporta automáticamente la anulación de la garantía, incluso a terceros.

The warranty is one year from the date of invoicing and covers faulty parts, the replacement and transportation of which will be borne by the purchaser.

The warranty does not cover the electrical parts or accessories, nor any other separable component. Any damage due to transportation or improper installation or maintenance shall not be considered as valid reasons for the purposes of the warranty.

Regular maintenance and repairs for reasons due to incorrect installation are not covered by the warranty. The warranty is valid only with respect to the first purchaser and does not provide for the replacement of the appliance.

MAINHO may carry out the repairs at the customer's site or in the factory, according to its own judgement. All transportation costs of the part or the equipment that need to be changed or repaired shall be borne by the customer. The material sent for repair must be accompanied by a duly completed return form specifying the incidents. If an inaccurate return form is received, the warranty will be cancelled.

MAINHO is not responsible for the possible delays that take place during the warranty period and does not compensate for any damage, direct or indirect, resulting from flaws or defects in the machinery provided, under the Civil Code.

Possible delays in the provision of the Service will not in any way give a right to the postponement of payments related to the equipment subject to the warranty. Delay of the payments, or the insolvency, including partial, of the customer, entails the automatic cancellation of the warranty.

Condiciones de venta

Terms of sale

- **Pedidos:** Se realizan por teléfono y serán confirmados por escrito a la dirección: mainho@mainho.com.
- **Forma de pago:** Primeras operaciones: mediante transferencia bancaria anticipada.
- **A crédito:** Hasta conceder crédito a un cliente, todas las operaciones serán abonadas mediante pago anticipado.
- **Impagados:** La existencia de un impagado bloqueará la cuenta del cliente. Cualquier efecto no atendido a su vencimiento deberá ser liquidado de inmediato, incluyendo todos los gastos producidos.
- **Transporte:** Pagados en la Península ibérica y Archipiélago Balear (exceptuando Portugal)
- **Riesgo transporte:** La mercancía viaja siempre por riesgo del comprador. En caso de deterioro o de roturas en el transporte, deberá hacerse la reclamación directamente a la agencia transportista.
- **Embalaje:** Incluido en el precio. Material protegido con plástico de burbuja, caja de cartón o jaula de madera.
- **Devolución de material:** Cualquier devolución de material deberá ser previamente autorizada por MAQUINARIA INDUSTRIAL HOSTELERA S.L.U. y reflejada por escrito, debiendo remitirse con su embalaje original. No se admiten devoluciones de material usado o manipulado. Todos los gastos generados, incluidos los portes, serán por cuenta del cliente.
- **Recambios y accesorios:** Se suministran siempre con pago anticipado.
- **Por defecto toda maquinaria fabricada o comercializada por MAINHO, está prevista para su funcionamiento a G.L.P. (gases licuados del petróleo) o sea, a butano / propano. A petición del cliente se puede efectuar el cambio en fábrica de los inyectores para funcionamiento a Gas Metano (Gas Natural), inyectores que están en dotación en todo aparato a gas, con un coste de 40,00.-euros/NETO, en concepto de desembalaje, desmontaje de los paneles necesarios, cambios de inyectores, montaje de los paneles y embalaje del aparato**

- **Orders:** They are made on the telephone and will be confirmed in writing to the address: export@mainho.com.
- **Form of payment:** First operations: by bank transfer in advance.
- **On credit:** Until a customer is given credit, all operations shall be paid by advance payment.
- **Unpaid items:** The existence of an unpaid item will block the customer's account. Any effect not paid for on its due date must be paid immediately, including all expenses incurred.
- **Transportation:** EXWORK
- **Transport risk:** Merchandise always travels at the risk of the purchaser. In the event of damage or breakage during transportation, the claim must be made directly to the carrier.
- **Packaging:** Included in the price. Material protected by bubble plastic, cardboard or wooden cage.
- **Return of material:** Any return of material must be previously authorised by MAQUINARIA INDUSTRIAL HOSTELERA S.L.U. and reflected in writing, and it must be sent in its original packaging. Returns of used or manipulated material are not accepted. All charges incurred, including delivery costs, shall be borne by the customer.
- **Spare parts and accessories:** Always supplied with advance payment.



Woks	Página 7
Fry-Tops	Página 15
Parrillas	Página 27
Serie Eco-Line	Página 35
Planchas	Página 47
Productos Snack	Página 59



Líneas 50-55	Página 61
Línea 60	Página 69
Shine Kitchen	Página 113
Línea 65	Página 129
Línea 70	Página 149
Línea 90	Página 245
Línea 110	Página 337
Monoblock y Encastrables	Página 355
Estructuras suspendidas	Página 389
Productos Snack	Página 407
Freidoras de pastelería	Página 415



Rational	Página 429
Delegaciones	Página 497

WOKS WOKS

**Cocinas profesionales,
para la cocción oriental.**

*Professional cookers
for oriental cooking.*

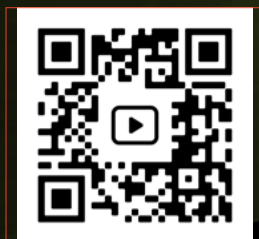

Woks



Profesionales & Económicos

Professional & Economical



W-300
Base encimera wok profesional
Professional wok cooktop base



W-200-ECO
Base encimera wok económico
Economical wok cooktop base

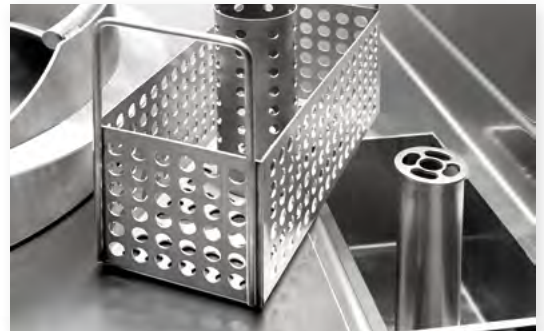

Cesta desagüe
Drainage basket



Aro Antitsunami
Anti-Tsunami ring

► Construidos totalmente en acero inoxidable. ► Quemadores atmosféricos de gran rendimiento. ► Encimera de acero inoxidable 18/8 de 3 mm de espesor, reforzada por tirantes internos. ► Fuegos de llama vertical dirigida al centro de la sartén wok, que realiza un abanico de calor por toda la superficie, consiguiendo una temperatura extrema e idónea para este tipo de cocción.

► Equipados con válvulas de gas con termopar de seguridad y llama piloto.

► **PROFESIONALES:** Aros Wok en acero inoxidable 18/8. ► Mandos ergonómicos en latón cromado.

► Encimera de trabajo tipo "bañera" con canal recoge-residuos, rebosadero y cesta adaptada a la extracción de los mismos.

► **ECONÓMICOS:** Aros Wok en acero pavonado negro. ► Mandos en ABS cromado.

► Entirely built in stainless steel. ► High performance atmospheric burners. ► Stainless steel cooktop 18/8 with thickness of 3 mm, reinforced by internal straps. ► Vertical flame burners directed to the centre of the wok, that spreads the heat over the entire surface, reaching an extreme and ideal temperature for this type of cooking.

► Equipped with gas valves with safety thermocouple and pilot light.

► **PROFESSIONAL:** Aros Wok in 18/8 stainless steel. ► Ergonomic controls in chrome-plated brass.

► "Bathtub" type worktop with waste collection channel, overflow and basket adapted for their removal.

► **ECONOMICAL:** - Aros Wok in blued black steel. ► Controls ABS chromed.

► Dimensiones y precios de la BASE WOK a falta de opciones y accesorios.

Dimensions and prices of the WOK BASE without options and accessories.

Modelos	Medidas exteriores	nº Fuegos	€
W-100	70x75x41h	1	2.857
W-200	100x75x41h	2	3.822
W-300	150x75x41h	3	5.113
W-400	200x75x41h	4	5.998
W-500	250x75x41h	5	6.670

Models	External dimensions	No. burners	€
W-100 ECO	70x70x41h	1	1.795
W-200 ECO	100x70x41h	2	2.780
W-300 ECO	150x70x41h	3	3.749
W-400 ECO	200x70x41h	4	4.872
W-500 ECO	250x70x41h	5	5.775

Base encimera wok profesional - Adaptables a todas las opciones de equipamiento.

Professional wok cooktop base - Adaptable to all equipment options.

Base encimera wok económica - Adaptable solo a quemadores y mesas de soporte.

Economical wok cooktop base - Adaptable only for burners and support bases.

Opciones de equipamiento

Equipment options



O-PW
Pared trasera de acero inox de 225mm de altura para ubicar los grifos.
 Rear wall of stainless steel 225mm height to fit the taps.

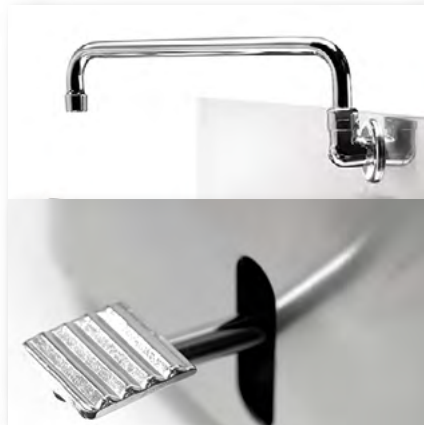

O-GPW
Grifo de pared orientable a pedal situado en los pies/mesa de soporte.
 Pedal-operated wall tap located on the supporting feet/table.



O-DW
Ducha de barrido, situada en la parte frontal de la bañera. Dirige los residuos hacia el canal recolector.
 Squirter, located at the front of the tub. It directs the waste into the collection channel.



O-MSW
Mesa de soporte con pies graduables en altura.
 Support table with adjustable height legs.



O-PSW
Conjunto de pies soporte graduables en altura.
 Set of adjustable height support legs.



O-QPW
Quemador de 12kW.
 12kW burner.



O-QGW
Quemador de 18kW, de alta potencia.
 18kW burner, high power.



O-GPWT
Grifo de pared orientable. Incluye la llave de paso manual.
 Swivel wall tap.
 Manual stopcock included.



O-CW
Cubetera/salsero.
 Bucket/sauce boat.

Realiza tu presupuesto

Make your own quote

¿Cuánto vale mi Wok?

How much does my Wok cost?

Para realizar tu propio presupuesto, seguimos 3 pasos:
To make your own quote, we follow 3 steps:

1. Elige Base Wok. (página nº8)

Choose Wok Base. (page no. 8)

2. Elige aquí equipamientos para tu Wok (columna derecha)

Select equipment for your Wok here (right column)

3. Suma el total de la base + equipamientos

Add total amount of the base + equipment

► Precios equipamientos - Prices equipment

Optional equipment	Worktop 1 burner	Worktop 2 burners	Worktop 3 burners	Worktop 4 burners	Worktop 5 burners
Equipamiento opcional	Encimera 1 fuego	Encimera 2 fuegos	Encimera 3 fuegos	Encimera 4 fuegos	Encimera 5 fuegos
O-PW-...	O-PW-1	O-PW-2	O-PW-3	O-PW-4	O-PW-5
Pared trasera	330 €	375 €	410 €	480 €	505 €
O-DW-..	O-DW-1	O-DW-2	O-DW-3	O-DW-4	O-DW-5
Ducha barrido	316 €	359 €	385 €	396 €	408 €
O-MSW-..	O-MSW-1	O-MSW-2	O-MSW-3	O-MSW-4	O-MSW-5
Mesa soporte *	475 €	520 €	575 €	758 €	820 €
O-GPW					
Grifo pedal	323 €	323 €	323 €	323€	323 €
O-PSW					
Pies soporte *	-	-	563 €	563 €	563 €
O-QPW					
Quemador 12kW *	318 €	318 €	318 €	318 €	318 €
O-QGW					
Quemador 18kW *	535 €	535 €	535 €	535 €	535 €
O-CW					
Cubetero /salsero**	487 €	487 €	487 €	487 €	487 €
O-GPWT					
Grifo manual	330 €	330 €	330 €	330 €	330 €
O-GSWT					
Grifo TOP manual	311 €	311 €	311 €	311 €	311 €
O-CSW					
Grifo sobre a pedal	336 €	336 €	336 €	336 €	336 €

(*) Elementos opcionales adaptables a cocinas profesionales y económicas.

(**) Incluye 6 cubetas GN 1/6 con sus tapas.

(*) Optional items adapted to professional and economical cookers.

(**) Includes 6 GN 1/6 tubs with their lids.



¿Tienes dudas sobre cómo realizar tu propio presupuesto?
Llama a nuestras oficinas.

Do you have any questions on how to make your own quote?
Call our office and we will help you.

Pared
O-PW-...
Wall
O-PW-



Grifo pared a pedal
O-GPW



Wall tap to pedal
O-GPW



Ducha barrido
O-DW-...



Sweeping shower
O-DW-...

Mesa soporte
O-MSW-...



Support table
O-MSW-...

Conjunto pies
soporte
O-PSW



Support leg
assembly
O-PSW

Quemador de 12 kW
O-QPW



12 kW burner
O-QPW

Quemador de 18 kW
O-QGW



18 kW burner
O-QGW

Grifo pared manual
O-GPWT

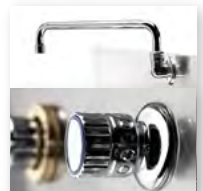

Manual wall tap
O-GPWT

Cubetero/salsero
O-CW



Bucket/sauce boat
O-CW

Opciones de equipamiento

Equipment options



Compuesta por / Composed by
Base profesional /
Professional base W-400 +



O-PW-4

+



O-GPWT

+



O-DW-4

+



O-QPW

+



O-QGW

Base WOK / Wok Base:

W-400

5.998 €

Equipamiento / Equipment:

1 x Pared / Wall (O-PW-4) 480 €

2 x Grifo manual / Manual tap (O-GPWT) 660 €

1 x Ducha barrido / Squirter (O-DW-4) 396 €

2 x Quemadores / Burners 12kW (O-QPW) 636 €

2 x Quemadores / Burners 18kW (O-QGW) 1.070 €

Total:

9.240 €



Compuesta por / Composed by:
Base profesional /
Professional base W-500 +



O-PW-5

+



O-GPW

+



O-DW-5

+



O-QPW

+



O-QGW

+



O-PSW

Base WOK / Wok Base:

W-500

6.670 €

Equipamiento / Equipment:

1 x Pared / Wall (O-PW-5) 505 €

2 x Grifo pedal / Pedal tap (O-GPW) 646 €

1 x Ducha barrido / Squirter (O-DW-5) 408 €

3 x Quemadores / Burners 12kW (O-QPW) 954 €

2 x Quemadores / Burners 18kW (O-QGW) 1.070 €

1 x Pies de soporte / Support feet (O-PSW) 563 €

Total:

10.816 €



Compuesta por / Composed by:
Base profesional /
Professional base W-200 +



O-PW-2

+



O-GPW

+



O-DW-2

+



O-QPW

+



O-QGW

+



O-MSW-2

+



O-CW

Base WOK / Wok Base:

W-200

3.822 €

Equipamiento / Equipment:

1 x Pared / Wall (O-PW-2) 375 €

1 x Grifo pedal / Pedal tap (O-GPW) 323 €

1 x Ducha barrido / Squirter (O-DW-2) 359 €

1 x Quemador / Burners 12kW (O-QPW) 318 €

1 x Quemador / Burners 18kW (O-QGW) 535 €

1 x Mesa de soporte / Support table (O-MSW-2) 520 €

1 x Cubetero / Salsero - Bucket / Sauce boat (O-CW) 487 €

Total:

6.739 €

Proyectos personalizados

Custom projects



Cocina mural WOK profesional
Wall cooker Professional WOK

Conjunto cocina WOK PROFESIONAL standard de 6 quemadores, 4 de 18kW y 2 de 12kW, soportado por dos pies para facilitar la limpieza del local. Formato tipo Z, intercalando los fuegos traseros con los delanteros, ajustando la medida de ancho a la mínima expresión posible.

Standard WOK PROFESSIONAL cooker unit with 6 burners, 4 of 18 kW and 2 of 12 kW, supported by two supporting legs to facilitate cleaning of the premises. Z-type format, interspersing the rear burners with the front ones, adjusting the width measurement to the minimum possible.



Cocina central Wok económico
Central cooker economical Wok

Conjunto cocina WOK versión ECONOMICA combinado con freidora de doble seno de una capacidad de 18+18 litros de aceite a gas, y con fry top cromado a gas, dotado de columna de agua articulada y de doble erogación, combinando así la cocina tradicional con la gastronomía asiática.

Combined ECONOMIC version WOK cooker unit with double fryer with a capacity of 18+18 litres of oil, gas powered and with chrome gas fry top, equipped with articulated water column and double dispensing, thus combining traditional cooking with Asian cuisine.



Imagina tu cocina asiática. Diseñala combinando los woks con los elementos que necesites para ajustar al máximo tu espacio de trabajo con tus necesidades. Pídenos presupuesto trabajaremos para hacer real tu proyecto.



Cocina mural Wok profesional
Wall cooker professional Wok

Conjunto mural multifunción, compuesto por 3 fuegos WOK versión profesional de 18kW, con un cuece pastas a gas de 40 litros, soporte cubetas Gastronorm 1/6x15cm, para ubicación de las salsas y barbacoa YAKITORI eléctrica sobre mostrador. Dispone de 3 grifos sobre fuegos wok, todo soportado por mueble neutro de puertas correderas.

Multifunction wall unit, consisting of 3 WOK burners, 18 kW professional version, with a 40-litre gas pasta cooker, 1/6x15 cm Gastronorm tub bracket for placing sauces and electric YAKITORI barbecue on the countertop. It has 3 taps on wok burners, all supported by a neutral unit with sliding doors.

Proyectos personalizados

Custom projects



Imagine your Asian cooker. Design it yourself by combining the woks with the items you need to adjust your workspace to your needs as far as possible. Ask for a quote, we will work to make your project real.



Cocina mural WOK profesional

Wall cooker professional WOK

Conjunto que combina 2 fuegos tradicionales con 4 fuegos WOK versión profesional de 18kW de potencia, en la parte central del equipo se ubica un fregadero. En el peto trasero se suministran cuatro grifos que alimentan de agua a los fuegos wok. Soportado por cuatro pies soporte.

Set of 10 WOK burners, professional version, 6 of 18 kW and 4 of 12 kW, arranged on two sides, one in line and the other in Z layout, equipped with two articulated water columns and double dispensing. Waste collection channel located in the centre of the equipment. All this is supported by a neutral table with a shelf.



Cocina central WOK profesional

Central cooker Professional WOK

Conjunto de 10 fuegos WOK versión profesional, 6 de 18kW y 4 de 12kW, organizados en dos lados, uno dispuestos en línea y el otro lado en disposición Z, dotado de dos columnas de agua articuladas y de doble erogación. Canal recoge residuos ubicado en el centro del equipo. Todo ello soportado por una mesa neutra con estante.

Unit that combines 2 traditional burners with 4 WOK burners professional version of 18 kW in power. There is a sink in the central part of the unit. Four taps are supplied in the backsplash that feed the wok burners with water. Supported by four support legs.



Cocina central TOP profesional

Cocina Central TOP profesional

Cocina WOK versión PROFESIONAL de 6 fuegos de 18kW, con columna de agua articulada y de doble erogación. Quemadores dispuestos en ambos lados en línea. Equipo preparado para una colocación sobre una superficie plana.

WOK PROFESSIONAL version cooker with 6 burners of 18 kW, with articulated water column and double dispensing. Burners arranged on both sides in line. Unit prepared for placement on a flat surface.

Accesorios

Accessories



► **W-300 + equipamientos + accesorios**
W-300 + equipment + accessories

Personaliza tu cocina Wok con accesorios tradicionales de la cocina asiática

Customise your Wok cooker with traditional accessories of Asian cooking



Z01209000033
Espumadera araña Ø 28cm
Spider skimmer



Z01209000031
Cucharón grande 0,75l
Large ladle



Z01209000030
Cucharón pequeño 0,25l
Small ladle



Z01208500008
Soporte contenedor
Container support



Z01209000021
Sarten Wok Ø 36cm
Wok frying pan



Z01209000028
Contenedor de agua
Water container



Z01209000011
Z01209000012
Z01209000013
Z01209000014
Especieros
Spice racks



Z01208500006
Soporte especieros
Spice rack support

Description	Código / Code	Descripción	€
Spice rack support	Z01208500006	Soporte especieros	187
Container support	Z01208500008	Soporte contenedor	103
Net cover spice rack	Z01209000011	Especiero tapa de red	18
Cover spice rack with holes diameter 1.2 mm	Z01209000012	Especiero tapa con agujeros diámetro 1,2 mm	14
Cover spice rack with holes diameter 3 mm	Z01209000013	Especiero tapa con agujeros diámetro 3 mm	14
Cover spice rack with holes diameter 4 mm	Z01209000014	Especiero tapa con agujeros diámetro 4 mm	14
Wok frying pan Ø 36 cm	Z01209000021	Sartén Wok Ø 36cm	180
Water container	Z01209000028	Contenedor de agua	41
Small ladle 0.25l	Z01209000030	Cucharón pequeño 0,25l	19
Large ladle 0.75l	Z01209000031	Cucharón grande 0,75l	30
Spider skimmer Ø 28 cm	Z01209000033	Espumadera araña Ø 28cm	29

FRY-TOPS

FRY-TOPS

**Más rendimiento,
menos consumo.**

*Today's barbecue,
with the same old taste.*

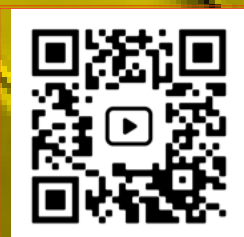



Serie Teppanyaki

Cromo duro & Rectificado - Hard chrome & Rectified steel



FC-120/7 TY



Barra de seguridad
Safety bar



Mando y tren de chispas
Control and multi-spark

- ▶ **Placa de cromo duro** de 20mm de espesor (FC/7-TY y FCE/7-TY). ▶ **Placa rectificada** de 20mm de espesor (FL/7-TY y FLE/7-TY).
- ▶ Cubetas recoge grasas de gran capacidad (GN 1/3x10h) situadas en el interior de cada pie/soporte. ▶ El peto y la chimenea sobresalen 10 mm por encima de la placa. ▶ Mandos ergonómicos en latón cromado.
- ▶ Encendido por tren de chispas a batería. ▶ Válvulas termostáticas EURO-SIT con llama piloto.
- ▶ Resistencias blindadas de acero inoxidable.

- ▶ **Hard chrome griddle** 20 mm thick (FC/7-TY and FCE/7-TY). ▶ **Rectified griddle** 20 mm thick (FL/7-TY and FLE/7-TY).
- ▶ Large capacity fat collector tubs (GN 1/3x10h) located inside each leg/support. ▶ The panel and flue protrude 10 mm above the griddle. ▶ Ergonomic controls in chrome-plated brass.
- ▶ Ignition by sparks to battery. ▶ EURO-SIT thermostatic valves with pilot light.
- ▶ Stainless steel shielded heating elements.

Modelos FCE / FLE: Trifásico 400V~3N 50/60Hz
Models FCE / FLE: Three-phase 400V~3N 50/60Hz

Modelos	Medidas exteriores	Superficie útil	Kg neto	kW	Kcal/h	Medidas embalaje	Kg bruto	m ³	€
FC-120/7 TY	120,5x82x86h	120x70	217	25	21.500	129x93x118h	261	1,42	6.874
FC-150/7 TY	150,5x82x86h	150x70	262	29,4	25.284	159x93x118h	307	1,74	7.982
FC-180/7 TY	180,5x82x86h	180x70	310	37,5	32.250	189x93x118h	358	2,07	8.924
FL-120/7 TY	120,5x82x86h	120x70	217	25	21.500	129x93x118h	261	1,42	6.210
FL-150/7 TY	150,5x82x86h	150x70	262	29,4	25.284	159x93x118h	307	1,74	6.949
FL-180/7 TY	180,5x82x86h	180x70	310	37,5	32.250	189x93x118h	358	2,07	7.629
FCE-120/7 TY	120,5x82x86h	120x70	217	12	-	129x93x118h	261	1,42	7.027
FCE-150/7 TY	150,5x82x86h	150x70	262	15	-	159x93x118h	307	1,74	8.268
FCE-180/7 TY	180,5x82x86h	180x70	310	18	-	189x93x118h	358	2,07	9.108
FLE-120/7 TY	120,5x82x86h	120x70	217	12	-	129x93x118h	261	1,42	6.392
FLE-150/7 TY	150,5x82x86h	150x70	262	15	-	159x93x118h	307	1,74	7.661
FLE-180/7 TY	180,5x82x86h	180x70	310	18	-	189x93x118h	358	2,07	8.502

EN DOTACIÓN - INCLUDED

- ▶ Espátula grande
- ▶ **Modelos en cromo duro:**
- ▶ Rasqueta de cromo duro
- ▶ Muestra de desengrasante
- ▶ **All models - Spatula**
- ▶ **Hard chrome models:**
- ▶ Hard chrome scraper
- ▶ Degreaser sample

Situación conexión
Connection situation

● Gas 3/4" ● Eléctrico

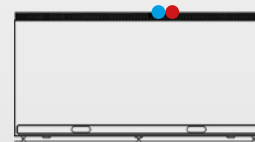

Serie Uni

Cromo duro & Rectificado - Hard chrome & Rectified steel



Cubeta residuos interna
Internal waste tray



FCE-150/7

- ▶ **Placa de cromo duro** de 20mm de espesor (FC/7 y FCE/7). ▶ **Placa rectificada** de 20mm de espesor (FL/7 y FLE/7).
- ▶ Cubetas recoge grasas de gran capacidad (GN 1/3x10h) situadas en el interior de cada pie/soporte.
- ▶ Mandos ergonómicos en latón cromado.
- 💧 Encendido por tren de chispas a batería. ▶ Válvulas termostáticas EURO-SIT con llama piloto.
- ⚡ Resistencias blindadas de acero inoxidable.

- ▶ **Hard chrome griddle** 20 mm thick (FC/7 and FCE/7). ▶ **Rectified griddle** 20 mm thick (FL/7 and FLE/7).
- ▶ Large capacity fat collector tubs (GN 1/3x10h) located inside each leg/support. ▶ Ergonomic controls in chrome-plated brass.
- 💧 Ignition by sparks to battery ▶ EURO-SIT thermostatic valves with pilot light.
- ⚡ Stainless steel shielded heating elements.

Modelos FCE / FLE: Trifásico 400V~3N 50/60Hz
Models FCE / FLE: Three-phase 400V~3N 50/60Hz

Modelos	Medidas exteriores	Superficie útil	Kg neto	kW	Kcal/h	Medidas embalaje	Kg bruto	m ³	€
FC-120/7	120,5x82x86h	120x70	217	25	21.500	129x93x118h	261	1,42	6.874
FC-150/7	150,5x82x86h	150x70	262	29,4	25.284	159x93x118h	307	1,74	7.982
FC-180/7	180,5x82x86h	180x70	310	37,5	32.250	189x93x118h	358	2,07	8.924
FL-120/7	120,5x82x86h	120x70	217	25	21.500	129x93x118h	261	1,42	6.210
FL-150/7	150,5x82x86h	150x70	262	29,4	25.284	159x93x118h	307	1,74	6.949
FL-180/7	180,5x82x86h	180x70	310	37,5	32.250	189x93x118h	358	2,07	7.629
FCE-120/7	120,5x82x86h	120x70	217	12	-	129x93x118h	261	1,42	7.027
FCE-150/7	150,5x82x86h	150x70	262	15	-	159x93x118h	307	1,74	8.268
FCE-180/7	180,5x82x86h	180x70	310	18	-	189x93x118h	358	2,07	9.108
FLE-120/7	120,5x82x86h	120x70	217	12	-	129x93x118h	261	1,42	6.392
FLE-150/7	150,5x82x86h	150x70	262	15	-	159x93x118h	307	1,74	7.661
FLE-180/7	180,5x82x86h	180x70	310	18	-	189x93x118h	358	2,07	8.502

EN DOTACIÓN - INCLUDED

Espátula grande
Modelos en cromo duro:
 Rasqueta de cromo duro
 Muestra de desengrasante
All models - Spatula
Hard chrome models:
 Hard chrome scraper
 Degreaser sample

Situación conexión
 Connection situation

● Gas 3/4" ● Eléctrico





Serie Teppanyaki sobre mostrador

Serie Teppanyaki Top

Cromo duro & Rectificado - Hard chrome & Rectified steel



FCT-120/7 TY
+ Opción: pies de soporte (PSFC-120/7)
+ Option: Support feet (PSFC-120/7)



Chimena Teppanyaki
Teppanyaki Flue

- ▶ **Placa de cromo duro** de 20mm de espesor (FCT/7-TY y FCET/7-TY).
- ▶ **Placa rectificada** de 20mm de espesor (FLT/7-TY y FLET/7-TY).
- ▶ Cajones recolectores dispuestos en el frontal, de fácil extracción y limpieza. ▶ El peto y la chimenea sobresalen 10 mm por encima de la placa. ▶ Mandos ergonómicos en latón cromado.
- ⬆ Encendido por tren de chispas a batería. ▶ Válvulas termostáticas EURO-SIT con llama piloto.
- ⚡ Resistencias blindadas de acero inoxidable.
- ▶ **Hard chrome griddle** 20 mm thick (FCT/7-TY and FCET/7-TY).
- ▶ **Rectified griddle** 20 mm thick (FLT/7-TY and FLET/7-TY).
- ▶ Large capacity fat collector tubs (GN 1/3x10 h) located inside each leg/support. ▶ The panel and flue protrude 10 mm above the griddle. ▶ Ergonomic controls in chrome-plated brass.
- ⬆ Ignition by sparks to battery. ▶ EURO-SIT thermostatic valves with pilot light.
- ⚡ Stainless steel shielded heating elements.

Modelos	Medidas exteriores	Superficie útil	Kg neto	kW	Kcal/h	Medidas embalaje	Kg bruto	m ³	€
FCT-120/7 TY	120,5x82x31h	120x70	170	25	21.500	130x95x70h	220	0,86	6.657
FCT-150/7 TY	150,5x82x31h	150x70	212	29,4	25.284	160x95x70h	275	1,06	7.671
FCT-180/7 TY	180,5x82x31h	180x70	255	37,5	32.250	190x95x70h	330	1,26	8.832
FLT-120/7 TY	120,5x82x31h	120x70	170	25	21.500	130x95x70h	220	0,86	5.988
FLT-150/7 TY	150,5x82x31h	150x70	212	29,4	25.284	160x95x70h	275	1,06	6.384
FLT-180/7 TY	180,5x82x31h	180x70	255	37,5	32.250	190x95x70h	330	1,26	7.616
FCET-120/7 TY	120,5x82x31h	120x70	170	12	-	130x95x70h	220	0,86	6.902
FCET-150/7 TY	150,5x82x31h	150x70	212	15	-	160x95x70h	275	1,06	8.007
FCET-180/7 TY	180,5x82x31h	180x70	255	18	-	190x95x70h	330	1,26	8.461
FLET-120/7 TY	120,5x82x31h	120x70	170	12	-	130x95x70h	220	0,86	6.414
FLET-150/7 TY	150,5x82x31h	150x70	212	15	-	160x95x70h	275	1,06	7.252
FLET-180/7 TY	180,5x82x31h	180x70	255	18	-	190x95x70h	330	1,26	8.305
Opciones de soporte: PSFC-Patas de soporte / MFC-Mesas - Support options: PSFC-Support legs - MFC-Tables									
PSFC-120/7	120x62x55h	-	66	-	-	130x95x70h	80	0,40	803
PSFC-150/7	150x62x55h	-	82	-	-	160x95x70h	105	0,50	823
PSFC-180/7	180x62x55h	-	97	-	-	190x95x70h	147	0,60	884
MFC-120/7	120x62x55h	-	76	-	-	130x95x70h	85	0,40	939
MFC-150/7	150x62x55h	-	94	-	-	160x95x70h	120	0,50	1.097
MFC-180/7	180x62x55h	-	106	-	-	190x95x70h	160	0,60	1.273
ZK-RFC/7	Kit ruedas FC/7 (2 con freno + 2 sin freno) / Kit wheels FC/7 (2 brakat + 2 unbraket)								472

EN DOTACIÓN - INCLUDED

- Espátula grande
- Modelos en cromo duro:**
- Rasqueta de cromo duro
- Muestra de desengrasante
- All models - Spatula
- Hard chrome models:
- Hard chrome scraper
- Degreaser sample



Modelos FCET / FLET:
Trifásico 400V~3N 50/60Hz
Models FCET / FLET:
Three-phase 400V~3N 50/60Hz

Situación conexión
Connection situation

- Gas 3/4"
- Eléctrico



Serie Uni sobre mostrador

Serie Uni Top

Cromo duro & Rectificado - Hard chrome & Rectified steel



Cajón recolector en el frontal
Collection drawer on the front



FCT-180/7
+ Opción: mesa de soporte (MSFC-180/7)
+ Option: Support table (MSFC-180/7)

- ▶ **Placa de cromo duro** de 20mm de espesor (FCT/7 y FCET/7).
- ▶ **Placa rectificada** de 20mm de espesor (FLT/7 y FLET/7).
- ▶ Cajones recolectores dispuestos en el frontal, de fácil extracción y limpieza.
- ▶ Mandos ergonómicos en latón cromado.
- 💧 Encendido por tren de chispas a batería. ▶ Válvulas termostáticas EURO-SIT con llama piloto.
- ⚡ Resistencias blindadas de acero inoxidable.

- ▶ **Hard chrome griddle** 20 mm thick (FCT/7 and FCET/7).
- ▶ **Rectified griddle** 20 mm thick (FLT/7 and FLET/7).
- ▶ Collection drawers arranged on the front, easy to remove and clean.
- ▶ Ergonomic controls in chrome-plated brass.
- 💧 Ignition by sparks to battery. ▶ EURO-SIT thermostatic valves with pilot light.
- ⚡ Stainless steel shielded heating elements.

Modelos	Medidas exteriores	Superficie útil	Kg neto	kW	Kcal/h	Medidas embalaje	Kg bruto	m ³	€
FCT-120/7	120,5x82x31h	120x70	170	25	21.500	130x95x70h	220	0,86	6.657
FCT-150/7	150,5x82x31h	150x70	212	29,4	25.284	160x95x70h	275	1,06	7.671
FCT-180/7	180,5x82x31h	180x70	255	37,5	32.250	190x95x70h	330	1,26	8.832
FLT-120/7	120,5x82x31h	120x70	170	25	21.500	130x95x70h	220	0,86	5.988
FLT-150/7	150,5x82x31h	150x70	212	29,4	25.284	160x95x70h	275	1,06	6.384
FLT-180/7	180,5x82x31h	180x70	255	37,5	32.250	190x95x70h	330	1,26	7.616
FCET-120/7	120,5x82x31h	120x70	170	12	-	130x95x70h	220	0,86	6.902
FCET-150/7	150,5x82x31h	150x70	212	15	-	160x95x70h	275	1,06	8.007
FCET-180/7	180,5x82x31h	180x70	255	18	-	190x95x70h	330	1,26	8.461
FLET-120/7	120,5x82x31h	120x70	170	12	-	130x95x70h	220	0,86	6.414
FLET-150/7	150,5x82x31h	150x70	212	15	-	160x95x70h	275	1,06	7.252
FLET-180/7	180,5x82x31h	180x70	255	18	-	190x95x70h	330	1,26	8.305

Opciones de soporte: PSFC-Patas de soporte / MFC-Mesas - Support options: PSFC-Support legs - MFC-Tables

PSFC-120/7	120x62x55h	-	66	-	-	130x95x70h	80	0,40	803
PSFC-150/7	150x62x55h	-	82	-	-	160x95x70h	105	0,50	823
PSFC-180/7	180x62x55h	-	97	-	-	190x95x70h	147	0,60	884
MFC-120/7	120x62x55h	-	76	-	-	130x95x70h	85	0,40	939
MFC-150/7	150x62x55h	-	94	-	-	160x95x70h	120	0,50	1.097
MFC-180/7	180x62x55h	-	106	-	-	190x95x70h	160	0,60	1.273
ZK-RFC/7	Kit ruedas FC/7 (2 con freno + 2 sin freno) / Kit wheels FC/7 (2 braknet + 2 unbraket)								472

EN DOTACIÓN - INCLUDED

- Espátula grande
- Modelos en cromo duro:**
- Rasqueta de cromo duro
- Muestra de desengrasante
- All models - Spatula
- Hard chrome models:
- Hard chrome scraper
- Degreaser sample



Modelos FCET / FLET:
Trifásico 400V~3N 50/60Hz
Models FCET / FLET:
Three-phase 400V~3N 50/60Hz

Situación conexión
Connection situation
● Gas 3/4" ● Eléctrico





Serie Euro-Crom Gas

Cromo duro - Hard chrome



PCR-90 N



Cajón recolector en el frontal
Collection drawer on the front

- ▶ **Placa de Cromo duro** de 20 mm de espesor.
- ▶ Cajones recolectores de grasas en ambos laterales.
- ◊ Encendido por tren de chispas a batería. ▶ Válvulas termostáticas EURO-SIT con llama piloto.
- ▶ **Semi-ranurados:** Modelo PCR-60 tiene 30 cm de ranurado. Modelos PCR-90 y PCR-120 tienen 40 cm.
- ▶ **Ranurados:** Modelos PCRR

- ▶ **Hard chrome griddle** 20 mm thick.
- ▶ Fat collection drawers on both sides.
- ◊ Ignition by sparks to battery. ▶ Thermostatic valves with pilot light.
- ▶ **Half-Slotted:** PCR-60 model has 30 cm of slots. PCR-90 and PCR-120 models are 40 cm.
- ▶ **Slotted:** PCRR

EN DOTACIÓN - INCLUDED

- Espátula pequeña
- Modelos en cromo duro:**
- Rasqueta de cromo duro
- Muestra de desengrasante
- Modelos ranurados:**
- Espátula ranurada
- All models - Spatula**
- Hard chrome models:**
- Hard chrome scraper
- Degreaser sample
- Grooved models:**
- Grooved spatula

Tipo de placa
Type of griddle



PC
Placa lisa
Smooth plate



PCR
Placa semi-ranurada
Half-slotted plate



PCRR
Placa ranurada
Slotted plate

Modelos	Medidas exteriores	Superficie útil	Kg neto	kW	Kcal/h	Medidas embalaje	Kg bruto	m ³	€
PC-60 N	61x60x25h	60x50	72	11	9.460	65x67x52h	80	0,23	2.416
PC-90 N	91x60x25h	90x50	105	19	16.340	95x67x54h	115	0,34	3.268
PC-120 N	121x60x25h	120x50	135	22	18.820	125x67x54h	147	0,45	3.844
PCR-60 N	61x60x25h	60x50	72	11	9.460	65x67x52h	80	0,23	2.627
PCR-90 N	91x60x25h	90x50	105	19	16.340	95x67x54h	115	0,34	3.479
PCR-120 N	121x60x25h	120x50	135	22	18.820	125x67x54h	147	0,45	4.079
PCRR-60 N	61x60x25h	60x50	72	11	9.460	65x67x52h	80	0,23	3.079
PCRR-90 N	91x60x25h	90x50	105	19	16.340	95x67x54h	115	0,34	4.013
PCRR-120 N	121x60x25h	120x50	135	22	18.820	125x67x54h	147	0,45	4.631

Situación conexión
Connection situation

- Gas 60: 1/2" - 90-120: 3/4"

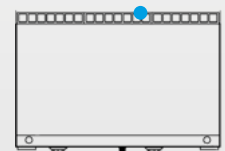

Serie Euro-Crom Eléctrico

Cromo duro - Hard chrome



Detalle placa ranurada
Detail of slotted plate



PC-120 ET

- ▶ **Placa de Cromo duro** de 20 mm de espesor.
- ▶ Cajones recolectores de grasas en ambos laterales.
- ⚡ Resistencias blindadas de acero inoxidable.
- ▶ **Semi-ranurados:** Modelo PCR-60 tiene 30 cm de ranurado. Modelos PCR-90 y PCR-120 tienen 40 cm.
- ▶ **Ranurados:** Modelos PCRR

- ▶ **Hard chrome plate** 20 mm thick.
- ▶ Fat collection drawers on both sides.
- ⚡ Stainless steel shielded heating elements.
- ▶ **Half-slotted:** PCR-60 model has 30 cm of slots. PCR-90 and PCR-120 models are 40 cm.
- ▶ **Slotted:** PCRR

EN DOTACIÓN - INCLUDED

- Espátula pequeña
- Modelos en cromo duro:**
- Rasqueta de cromo duro
- Muestra de desengrasante
- Modelos ranurados:**
- Espátula ranurada
- All models - Spatula
- Hard chrome models:**
- Hard chrome scraper
- Degreaser sample
- Grooved models:**
- Grooved spatula

Tipo de placa
Type of griddle



PC
Placa lisa
Smooth plate



PCR
Placa semi-ranurada
Half-slotted plate



PCRR
Placa ranurada
Slotted plate

Modelos	Medidas exteriores	Superficie útil	Kg neto	kW	Medidas embalaje	Kg bruto	m ³	€
PC-60ET	61x60x25h	60x50	72	6	65x67x52h	80	0,23	2.392
PC-90ET	91x60x25h	90x50	105	9	95x67x54h	115	0,34	3.262
PC-120ET	121x60x25h	120x50	135	12	125x67x54h	147	0,45	3.819
PCR-60ET	61x60x25h	60x50	72	6	65x67x52h	80	0,23	2.602
PCR-90ET	91x60x25h	90x50	105	9	95x67x54h	115	0,34	3.583
PCR-120ET	121x60x25h	120x50	135	12	125x67x54h	147	0,45	4.055
PCRR-60ET	61x60x25h	60x50	72	6	65x67x52h	80	0,23	2.940
PCRR-90ET	91x60x25h	90x50	105	9	95x67x54h	115	0,34	3.845
PCRR-120ET	121x60x25h	120x50	135	12	125x67x54h	147	0,45	4.488



Trifásico 400V~3N 50/60Hz
Three-phase 400V~3N 50/60Hz

Situación conexión
Connection situation

● Eléctrico

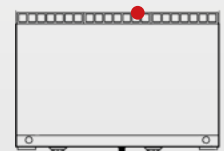



Serie Euro-Snack Gas

Rectificado - Rectified steel



PL-90 N



Chimenea de fundición de fácil extracción y limpieza
Easy to remove and clean cast iron flue

- ▶ **Placa de acero rectificado** de 20 mm de espesor.
- ▶ Cajones recolectores de grasas en ambos laterales.
- ⬢ Encendido por tren de chispas a batería. ▶ Válvulas de gas con termopar de seguridad y llama piloto.
- ▶ **Semi-ranurados:** Modelo PLR-60 tiene 30 cm de ranurado. Modelos PLR-90 y PLR-120 tienen 40 cm.
- ▶ **Ranurados:** Modelos PLRR

- ▶ **Rectified steel plate** 20 mm thick.
- ▶ Fat collection drawers on both sides.
- ⬢ Ignition by sparks to battery. ▶ EURO-SIT thermocouple valves with pilot light.
- ▶ **Half-Slotted:** PLR-60 model has 30 cm of slots. PLR-90 and PLR-120 models are 40 cm.

<p>Tipo de placa Type of plate</p>	 PL Placa lisa Smooth plate	 PLR Placa semi-ranurada Half-slotted plate	 PLRR Placa ranurada Slotted plate
--	--	--	--

EN DOTACIÓN - INCLUDED

- Espátula pequeña
- Modelos ranurados:**
- Espátula ranurada
- All models - Spatula
- Grooved models:
- Grooved spatula

Modelos	Medidas exteriores	Superficie útil	Kg neto	kW	Kcal/h	Medidas embalaje	Kg bruto	m ³	€
PL-60 N	61x60x25h	60x50	72	11	9.460	65x67x52h	80	0,23	2.013
PL-90 N	91x60x25h	90x50	105	19	16.340	95x67x54h	115	0,34	2.690
PL-120 N	121x60x25h	120x50	135	22	18.820	125x67x54h	147	0,45	3.134
PLR-60 N	61x60x25h	60x50	72	11	9.460	65x67x52h	80	0,23	2.224
PLR-90 N	91x60x25h	90x50	105	19	16.340	95x67x54h	115	0,34	2.901
PLR-120 N	121x60x25h	120x50	135	22	18.820	125x67x54h	147	0,45	3.369
PLRR-60 N	61x60x25h	60x50	72	11	9.460	65x67x52h	80	0,23	2.375
PLRR-90 N	91x60x25h	90x50	105	19	16.340	95x67x54h	115	0,34	3.263
PLRR-120 N	121x60x25h	120x50	135	22	18.820	125x67x54h	147	0,45	3.921

Situación conexión
Connection situation

- Gas 60: 1/2" - 90-120: 3/4"

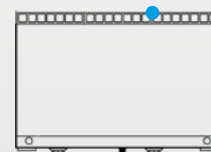

Serie Euro-Snack Eléctrico

Rectificado - Rectified steel



Pilotos LEDS
LED lights



PL-60 ET

- ▶ **Placa de acero rectificad**o de 20 mm de espesor.
- ▶ Cajones recolectores de grasas en ambos laterales.
- ⚡ Resistencias blindadas de acero inoxidable.
- ▶ **Semi-ranurados:** Modelo PLR-60 tiene 30 cm de ranurado. Modelos PLR-90 y PLR-120 tienen 40 cm.
- ▶ **Ranurados:** Modelos PLRR

- ▶ **Rectified steel plate** 20 mm thick.
- ▶ Fat collection drawers on both sides.
- ⚡ Stainless steel shielded heating elements.
- ▶ **Half-slotted:** PCR-60 model has 30 cm of slots. PCR-90 and PCR-120 models are 40 cm.

Tipo de placa
Type of plate



PL
Placa lisa
Smooth plate



PLR
Placa semi-ranurada
Half-slotted plate



PLRR
Placa ranurada
Slotted plate

EN DOTACIÓN - INCLUDED

Espátula pequeña
Modelos ranurados:
Espátula ranurada
All models - Spatula
Grooved models:
Grooved spatula



Trifásico 400V~3N 50/60Hz
Three-phase 400V~3N 50/60Hz

Situación conexión
Connection situation

● Eléctrico

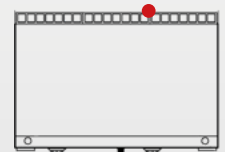

Modelos	Medidas exteriores	Superficie útil	Kg neto	kW	Medidas embalaje	Kg bruto	m ³	€
PL-60ET	61x60x25h	60x50	72	6	65x67x52h	80	0,23	2.061
PL-90ET	91x60x25h	90x50	105	9	95x67x54h	115	0,34	2.841
PL-120ET	121x60x25h	120x50	135	12	125x67x54h	147	0,45	3.269
PLR-60ET	61x60x25h	60x50	72	6	65x67x52h	80	0,23	2.273
PLR-90ET	91x60x25h	90x50	105	9	95x67x54h	115	0,34	3.052
PLR-120ET	121x60x25h	120x50	135	12	125x67x54h	147	0,45	3.506
PLRR-60ET	61x60x25h	60x50	72	6	65x67x52h	80	0,23	2.295
PLRR-90ET	91x60x25h	90x50	105	9	95x67x54h	115	0,34	3.111
PLRR-120ET	121x60x25h	120x50	135	12	125x67x54h	147	0,45	3.847



Serie Full-Crom

Cromo duro - Hard chrome

FCE-60 N

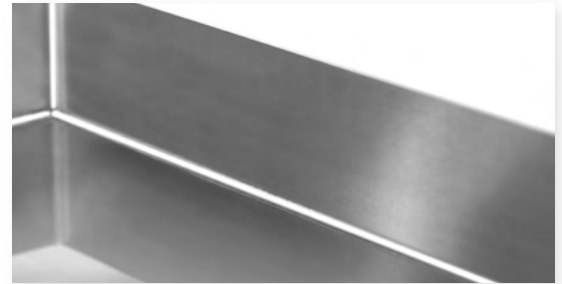

Soldaduras herméticas
Hermetic welding

FCR-90 N



Aportación de aire
Air supply

- ▶ **Placa de Cromo duro** de 20 mm de espesor ▶ Cajón recolector delantero.
- ◊ Encendido por tren de chispas a batería. ▶ Válvulas termostáticas con llama piloto. ⚡ Resistencias blindadas de acero inoxidable.
- ▶ **Semi-ranurados:** Modelo FCR-60 tiene 30 cm de ranurado. Modelos FCR-90 y FCR-120 tienen 40 cm.
- ▶ **Ranurados:** Modelos FCRR.
- ▶ **Hard chrome plate** 20 mm thick ▶ Front collection drawer.
- ◊ Ignition by sparks to battery. ▶ Thermostatic valves with pilot light. ⚡ Stainless steel shielded heating elements.
- ▶ **Half-slotted:** FCR-60 model has 30 cm of slots. FCR-90 and FCR-120 models are 40 cm.
- ▶ **Slotted:** Models FCRR.

Tipo de placa
Type of plate



FC
Placa lisa
Smooth plate



FCR
Placa semi-ranurada
Half-slotted plate



FCRR
Placa ranurada
Slotted plate

Modelos	Medidas exteriores	Superficie útil	Kg neto	kW	Kcal/h	Medidas embalaje	Kg bruto	m ³	€
FC-60	60,5x56x22,5h	60x50	64	10,5	9.084	65x62x38h	70	0,15	1.991
FC-90	90,5x56x22,5h	90x50	95	14,6	12.556	95x62x40h	103	0,24	2.555
FC-120	120,5x56x22,5h	120x50	122	21	18.168	125x62x40h	133	0,31	3.046
FCR-60	60,5x56x22,5h	60x50	64	10,5	9.084	65x62x38h	70	0,15	2.115
FCR-90	90,5x56x22,5h	90x50	95	14,6	12.556	95x62x40h	103	0,24	2.789
FCR-120	120,5x56x22,5h	120x50	122	21	18.168	125x62x40h	133	0,31	3.298
FCRR-60	60,5x56x22,5h	60x50	64	10,5	9.084	65x62x38h	70	0,15	2.461
FCRR-90	90,5x56x22,5h	90x50	95	14,6	12.556	95x62x40h	103	0,24	2.948
FCRR-120	120,5x56x22,5h	120x50	122	21	18.168	125x62x40h	133	0,31	3.945
FCE-60	60,5x56x22,5h	60x50	69	6	-	65x62x38h	75	0,15	2.136
FCE-90	90,5x56x22,5h	90x50	101	9	-	95x62x40h	109	0,24	2.911
FCE-120	120,5x56x22,5h	120x50	130	12	-	125x62x40h	141	0,31	3.389
FCRE-60	60,5x56x22,5h	60x50	69	6	-	65x62x38h	75	0,15	2.315
FCRE-90	90,5x56x22,5h	90x50	101	9	-	95x62x40h	109	0,24	3.144
FCRE-120	120,5x56x22,5h	120x50	130	12	-	125x62x40h	141	0,31	3.639
FCRRE-60	60,5x56x22,5h	60x50	69	6	-	65x62x38h	75	0,15	2.609
FCRRE-90	90,5x56x22,5h	90x50	101	9	-	95x62x40h	109	0,24	3.404
FCRRE-120	120,5x56x22,5h	120x50	130	12	-	125x62x40h	141	0,31	4.234

EN DOTACIÓN - INCLUDED

- Espátula pequeña
- Modelos en cromo duro:**
- Rasqueta de cromo duro
- Muestra de desengrasante
- Modelos ranurados:**
- Espátula ranurada
- All models - Spatula
- Hard chrome models:**
- Hard chrome scraper
- Degreaser sample
- Grooved models:**
- Grooved spatula



Modelos
FCE / FCRE / FCRRE
Trifásico 400V-3N 50/60Hz
Models
FCE - FCRE - FCRRE
Three-phase 400V~3N 50/60Hz

Situación conexión
Connection situation

- Gas 60: 1/2" - 90-120: 3/4"
- Eléctrico



Mesas y chasis de soporte

Tables and support chassis

Mesas y chasis adaptados a todas las series de fry-tops, excepto gran rendimiento.

Tables and chassis adapted to all fry-tops series, except high performance.

- ▶ Construidas totalmente en acero inoxidable.
 - ▶ Desmontables.
 - ▶ Altura a la zona de trabajo del equipo: 85 cm.
 - ▶ Patas graduables en 6 cm de altura.
 - ▶ **Puertas, estante y ruedas opcionales.**
-
- ▶ Support tables built entirely in stainless steel.
 - ▶ Detachable.
 - ▶ Height to the working area of the equipment: 85cm.
 - ▶ Adjustable legs by 6 cm in height.
 - ▶ **Optional doors, shelf and wheels.**



PCR-90 N + MFTP-90
+ EMFTP-90 + 3xPMFTP-30

Modelos	Descripción	Compatible con...	Medidas exteriores	Kg neto	Medidas embalaje	Kg bruto	m ³	€
MFTP-60	Mesa fry-top 60cm	PC PL FC / PB PBI PBV	60x49x62h	14	68x56x12h	15	0,05	435
MFTP-90	Mesa fry-top 90cm	PC PL FC / PB PBI PBV	90x49x62h	19	98x56x12h	21	0,07	504
MFT-120	Mesa fry-top 120cm	PC PL FC	120x49x62h	23	128x56x12h	25	0,09	591
EMFTP-60	Estante fry-top 60cm	PC PL FC / PB PBI PBV	51,5x49x2,5h	2,5	54x53x4,5h	3	0,01	125
EMFTP-90	Estante fry-top 90cm	PC PL FC / PB PBI PBV	81,5x49x2,5h	4,5	84x51x4,5h	5	0,02	136
EMFT-120	Estante fry-top 120cm	PC PL FC	111,5x49x2,5h	6,5	115x51x4,5h	7	0,03	152
PMFTP-30	Puerta	Todas las mesas	30x47x2h	2	32x50x6h	2,5	0,01	156
RM	Rueda sin freno	-	Ø 80mm	0,5	-	-	-	47
RMF	Rueda con freno	-	Ø 80mm + freno	0,75	-	-	-	65

Chasis de soporte

Support chassis

- ▶ Chasis construidos totalmente en acero inoxidable.
- ▶ Desmontables. ▶ Altura a la zona de trabajo del equipo: 85 cm.
- ▶ Patas graduables en 6 cm de altura. ▶ **Ruedas opcionales.**
- ▶ Chassis built entirely in stainless steel ▶ Detachable
- ▶ Height to the working area of the equipment: 85 cm
- ▶ Adjustable legs by 6cm in height. ▶ **Optional wheels.**



FCR-90 N + STP/FC-90

Modelos	Compatible con	Medidas exteriores	Kg neto	Medidas embalaje	Kg bruto	m ³	€
STP/FC-60	PC PL FC	60x50x60h	17	68x56x12h	18	0,05	500
STP/FC-90	PC PL FC	90x50x60h	20	98x56x12h	22	0,07	556
STE-120	PC PL FC	120x50x60h	22	128x56x12h	24	0,09	611

Accesorios

Accessories



Z-C-1
Rasqueta para cromo duro
Hard chrome scraper



Z-C-2
Rasqueta para superficie ranurada
Slotted texture scraper



Z-E-1
Espátula
Spatula



Z-E-2
Espátula pequeña
Small spatula



PAC - 1
Desengrasante
Degreaser

**Todos los accesorios para fry-tops están
construidos totalmente en acero inoxidable y
aprobados por la Normativa CE**

All fry-tops accessories are entirely built in stainless steel and approved
by EC Standards

Modelos	Descripción / Description	€
ZK-PAC-1	Desengrasante 1u. / Degreaser 1u.	34
ZK-PAC-6	Desengrasante 6u. / Degreaser 6u.	132
ZK-PAC-12	Desengrasante 12u. / Degreaser 12u.	250
Z-C-1	Rasqueta de cromo duro / Hard chrome scraper	47
Z-C-2	Rasqueta para superficie ranurada / Sloted texture scraper	18
Z-E-1	Espátula / Sptula	14
Z-E-2	Espátula pequeña / Small spatula	13

GRILLS

PARRILLAS

La brasa de hoy,
con el sabor de siempre.

*Today's barbecue,
with the same old taste.*





Royal Grill

Gran rendimiento - High performance



PSI-120



Rejillas escalonadas
Staggered racks



Carbón refractario
Refractory coal

- ▶ Parrillas de carbón volcánico incombustible y refractario.
- ▶ Construidas totalmente en acero inoxidable.
- ▶ Rejillas regulables en la altura trasera.
- ▶ Cajones recolectores de residuos.
- ▶ Mandos ergonómicos en latón cromado.
- ▶ Quemadores extraíbles para facilitar la limpieza.
- ▶ Encendido por tren de chispas a batería.
- ▶ Patas regulables en 6 cm de altura.
- ▶ Válvulas de gas con termopar de seguridad y llama piloto.

- ▶ Fireproof and refractory volcanic carbon grills.
- ▶ Entirely built in stainless steel.
- ▶ Adjustable racks at the rear height.
- ▶ Waste collecting drawers.
- ▶ Ergonomic controls in chrome-plated brass.
- ▶ Removable burners to facilitate cleaning.
- ▶ Ignition by sparks to battery.
- ▶ Adjustable legs by 6 cm in height.
- ▶ Gas valves with safety thermocouple and pilot light.

Situación conexión

Connection situation

- Gas 3/4"

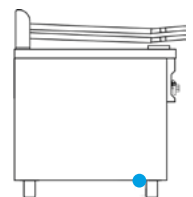

Modelos	Medidas exteriores	Superficie útil	Kg neto	kW	Kcal/h	Medidas embalaje	Kg bruto	m ³	€
PSI-80	80x90x85h	70x63	120	22	18.920	87x109x125h	166	1,19	4.846
PSI-120	120x90x85h	105x63	179	33	28.380	130x109x125h	229	1,77	6.863
PSI-160	160x90x85h	140x63	249	44	37.840	170x109x125h	299	2,32	8.220

Bras Grill

Inoxidable & pavonada - Stainless steel & blued



Elevador de rejillas
Rack lifter



Recolector integrado
Built-in collector



PBI-90



PB-90

- ▶ Parrillas de carbón volcánico incombustible y refractario. ▶ Construidas totalmente en acero inoxidable. ▶ Recolector de grasas de fácil extracción integrado en el marco frontal. ▶ Válvulas de gas con termopar de seguridad.
- ▶ Baterías de quemadores tubulares esmaltados vitrificados al fuego.
- ▶ Altura regulable de forma independiente en ambos lados.
- ▶ **Rejillas:** de serie acanaladas - **Opcional: de varilla.**

- ▶ Fireproof and refractory volcanic carbon grills. ▶ Entirely built in stainless steel. ▶ Easily removable fat collector built into the front frame. ▶ Gas valves with safety thermocouple. ▶ Batteries of fire-vitrified glazed tubular burners. ▶ Adjustable height separately on both sides.
- ▶ **Racks:** Standard fitted slotted - **Optional: rod.**

PB: Rejillas superiores en acero pavonado negro - PBI: Rejillas superiores en acero inoxidable.

PB: Top racks in blued black steel. - PBI: Top racks in stainless steel.

Modelos	Medidas exteriores	Superficie útil	Kg neto	kW	Kcal/h	Medidas embalaje	Kg bruto	m ³	€
PB-30	33x55x25,5h	27x47,5	23	7,58	6.518	37x64x35h	25	0,08	995
PB-60	60x55x25,5h	54x47,5	39	15,16	13.037	66x64x46h	46	0,19	1.519
PB-90	90x55x25,5h	82x47,5	54	22,74	19.556	96x64x48h	64	0,29	1.939
PB-120	114x55x25,5h	109x47,5	73	30,32	26.075	119x64x48h	83	0,37	2.287
PBI-30	33x55x25,5h	27x47,5	23	7,58	6.518	37x64x35h	25	0,08	1.043
PBI-60	60x55x25,5h	54x47,5	39	15,16	13.037	66x64x46h	46	0,19	1.583
PBI-90	90x55x25,5h	82x47,5	54	22,74	19.556	96x64x48h	64	0,29	2.036
PBI-120	114x55x25,5h	109x47,5	73	30,32	26.075	119x64x48h	83	0,37	2.419

Situación conexión
Connection situation
● Gas 1/2"

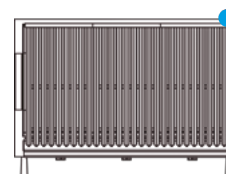



Vasca Inox

Acero inoxidable - Stainless steel



PBV-60



Alturas traseras regulables
Adjustable rear heights



Rejilla acanalada/rejilla de varilla
Ribbed rack/rod rack

- ▶ Parrillas de carbón volcánico incombustible y refractario.
 - ▶ Construidas totalmente en acero inoxidable.
 - ▶ Recolector de grasas integrado en el marco frontal.
 - ▶ Válvulas de gas con termopar de seguridad.
 - ▶ Peto perimetral inoxidable.
 - ▶ Baterías de quemadores tubulares esmaltados vitrificados al fuego.
 - ▶ Rejillas regulables en altura trasera.
 - ▶ **Rejillas** de serie: de varilla - **Opcional: acanaladas.**
-
- ▶ Fireproof and refractory volcanic carbon grills.
 - ▶ Entirely built in stainless steel.
 - ▶ Fat collector built into the front frame.
 - ▶ Gas valves with safety thermocouple.
 - ▶ Stainless steel perimeter panel.
 - ▶ Batteries of fire-vitrified glazed tubular burners.
 - ▶ **Racks** adjustable in the rear height.
 - ▶ **Racks** Standard fitted: rod - **Optional: slotted.**

Situación conexión
Connection situation
● Gas 1/2"

Modelos	Medidas exteriores	Superficie útil	Kg neto	kW	Kcal/h	Medidas embalaje	Kg bruto	m ³	€
PBV-60	60x55x25,5h	54x47,5	45	15,16	13.037	66x64x46h	52	0,19	1.708
PBV-90	90x55x25,5h	82x47,5	63	22,74	19.556	96x64x48h	73	0,29	2.193
PBV-120	114x55x25,5h	109x47,5	83	30,32	26.075	119x64x48h	93	0,37	2.666

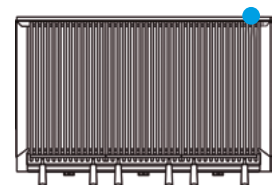



Nova Grill

Parrillas de agua - Water grills



Bandejas contenedoras de agua
Water container trays



NG-90

EN DOTACIÓN - INCLUDED

Espátula - Spatula

► Construidas totalmente en acero inoxidable. ► Parrillas con sistema de bandejas contenedoras de agua, eliminando un 80% de humos y llamas. ► Elementos superiores desmontables y de fácil limpieza. ► Sistema de calefacción a través de radiación por pabellones. ► Encendido por tren de chispas a batería. ► Válvulas de gas con termopar de seguridad y llama piloto.

► Entirely built in stainless steel. ► Grills with water container tray system, eliminating 80% of fumes and flames. ► Removable top elements, easy to clean. ► Heating system by radiation through horns. ► Ignition by battery piezoelectric. ► Gas valves with safety thermocouple and pilot light.

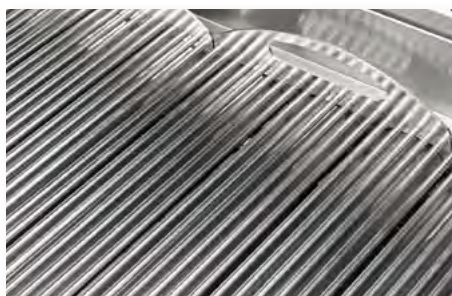

Rejilla
Grill



Pabellones
Horns



Quemadores
Burners

Situación conexión

Connection situation

● Gas

NG-33 - 1/2"

NG-62/90 - 3/4"

Modelos	Medidas exteriores	Superficie útil	Kg neto	kW	Kcal/h	Medidas embalaje	Kg bruto	m ³	€
NG-33	33x55,5x30,5h	28,5x42	21	7	6.020	42x71x61h	26	0,18	1.416
NG-62	62x55,5x30,5h	57x42	36	14	12.040	65x67x52h	44	0,23	2.105
NG-90	90x55,5x30,5h	85,5x42	52	21	18.060	95x67x54h	62	0,34	2.961

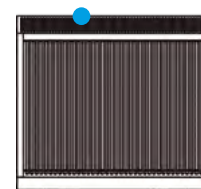

Tapa aceleradora del asado

Roast accelerator cover



PBV-60 + THP-60

- ▶ Construidas totalmente en acero inoxidable 18/8, de 1,5 mm de espesor.
- ▶ Formato cóncavo para evitar las pérdidas de calorías, consiguiendo un 60% más de rapidez en la cocción. ▶ Asa de elevación protegida.
- ▶ Incluye un termómetro para la medición de la temperatura en la cámara.
- ▶ Adaptadas a las parrillas Serie Bras Grill (PB), Bras Grill Inox (PBI) y Vasca Inox (PBV).
- ▶ **Series PB y PBI:** Debe adquirirse el peto inoxidable PT-60 o PT-90. (Ver página 34).

- ▶ Entirely made in 18/8 stainless steel, 1.5 mm thick. ▶ Concave format to avoid losses of calories, achieving 60% faster cooking. ▶ Protected lifting handle. ▶ Includes a thermometer to measure the temperature in the chamber. ▶ Adapted to Bras Grill (PB), Bras Grill Inox (PBI) and Vasca Inox (PBV) grill series.
- ▶ **PB and PBI series:** PT-60 or PT-90 stainless steel panel must be purchased. (See page 34).



Tapa cerrada
Closed cover



Tapa abierta
Open cover



Control de la temperatura
Temperature control

Modelos	Medidas exteriores	Kg neto	Medidas embalaje	Kg bruto	m ³	€
THP-60	65,5x50x22h	9	69x57x25h	13	0,10	495
THP-90	95,5x50x22h	11	99x57x25h	15	0,14	560

Mesas y chasis de soporte

Tables and support chassis

Mesas y chasis adaptadas a todas las series de parrillas, excepto Royal Grill.

Adapted tables and chassis to series: Bras Grill, Vasca Inox and Nova Grill

- ▶ Construidas totalmente en acero inoxidable.
 - ▶ Desmontables.
 - ▶ Altura a la zona de trabajo del equipo: 85 cm.
 - ▶ Patas graduables en 6 cm de altura.
 - ▶ **Puertas, estante y ruedas opcionales.**
- ▶ Support tables built entirely in stainless steel.
 - ▶ Detachable.
 - ▶ Height to the working area of the equipment: 85cm.
 - ▶ Adjustable legs by 6 cm in height.
 - ▶ **Optional doors, shelf and wheels.**



PBI-90
+ Z-PT-90
+ THP-90
+MFTP-90
+ 3xPMFTP-30
+ EMFTP-90

Modelos	Descripción	Compatible con...	Medidas exteriores	Kg neto	Medidas embalaje	Kg bruto	m ³	€
MFTP-60	Mesa parrilla 60cm	PB PBI PBV / PC PL FC	60x49x62h	14	68x56x12h	15	0,05	435
MFTP-90	Mesa parrilla 90cm	PB PBI PBV / PC PL FC	90x49x62h	19	98x56x12h	21	0,07	504
MPB-120	Mesa parrilla 120cm	PB PBI PBV	114x49x62h	24	128x56x12h	26	0,09	650
EMFTP-60	Estante parrilla 60cm	PB PBI PBV / PC PL FC	51,5x49x2,5h	2,5	54x53x4,5h	3	0,01	125
EMFTP-90	Estante parrilla 90cm	PB PBI PBV / PC PL FC	81,5x49x2,5h	4,5	84x51x4,5h	5	0,02	136
EMPB-120	Estante parrilla 120cm	PB PBI PBV	105,5x49x2,5h	6,5	115x51x4,5h	7	0,03	174
PMFTP-30	Puerta	Todas las mesas	30x47x2h	2	32x50x6h	2,5	0,01	156
RM	Rueda sin freno	-	Ø 80mm	0,5	-	-	-	47
RMF	Rueda con freno	-	Ø 80mm+freno	0,75	-	-	-	65

Chasis de soporte

Support chassis

- ▶ Chasis construidos totalmente en acero inoxidable.
- ▶ Desmontables ▶ Altura a la zona de trabajo del equipo: 85 cm.
- ▶ Patas graduables en 6 cm de altura. ▶ **Ruedas opcionales.**
- ▶ Chassis built entirely in stainless steel.
- ▶ Detachable. ▶ Height to the working area of the equipment: 85 cm.
- ▶ Adjustable legs by 6cm in height. ▶ **Optional wheels.**



NG-90 + STNG-90

Modelos	Compatible con...	Medidas exteriores	Kg neto	Medidas embalaje	Kg bruto	m ³	€
STP/FC-60	PB PBI PBV	60x50x60h	17	68x56x12h	18	0,05	500
STP/FC-90	PB PBI PBV	90x50x60h	20	98x56x12h	22	0,07	556
STP-120	PB PBI PBV	114x50x60h	22	128x56x12h	24	0,09	605
STNG-62	NG-62	62x50x55h	16	68x56x12h	18	0,05	550
STNG-90	NG-90	90x50x55h	20	98x56x12h	22	0,07	590

Accesorios

Accessories



Z-CR-1

Bolsa de carbón
Bag of charcoal



Z-RII / Z-RIIE9

**Rejilla inferior soporte carbón/
Especial para PB-PBI y PBV-90**
Bottom rack coal support/
Special for PB-PBI and PBV-90



Z-PT

**Peto en acero inox para
modelos PB-PBI**
Stainless steel panel for
PB and PBI



Z-RVF

Rejilla varilla para PB
Rod rack for PB

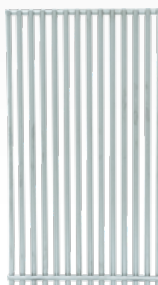

Z-RVI

Rejilla de varilla para PBI
Rod rack for PBI



Z-RAF

Rejilla acanalada para PB
Slotted rack for PB

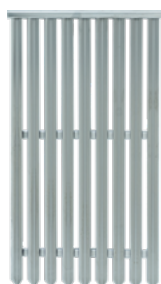

Z-RAI

Rejilla acanalada inox para PBI
Slotted stainless steel rack for PBI



Z-RVIV

Rejilla varilla inox para PBV
Rod stainless steel rack for PBV



Z-RAIV

Rejilla acanalada inox para PBV
Slotted stainless steel rack for
PBV

Modelos	Descripción	€
Z-CR-1	1 Bolsa de carbón / 1 Bag of charcoal	63
Z-PT-60	Peto inoxidable para modelos PB y PBI / 60 / Stainless steel panel for PB and PBI / 60 models	146
Z-PT-90	Peto inoxidable para modelos PB y PBI / 90 / Stainless steel panel for PB and PBI / 90 models	158
Z-PT-120	Peto inoxidable para modelos PB y PBI / 120 / Stainless steel panel for PB and PBI / 120 models	175
Z-RII	Rejilla inferior soporte carbón / Bottom rack coal support	79
Z-RIIE9	Rejilla inferior soporte carbón especial para PB-PBI y PBV-90 / Special bottom rack coal support for PB-PBI and PBV-90	84
Z-RVF	Rejilla de varilla para serie PB / Rod rack for PB series	27
Z-RVI	Rejilla de varilla inox para serie PBI / Stainless rod rack for PBI series	101
Z-RAF	Rejilla acanalada para serie PB / Slotted rack for PB series	38
Z-RAI	Rejilla inox acanalada para serie PBI / Slotted stainless steel rack for PBI series	98
Z-RVIV	Rejilla inox varilla para modelos PBV / Rod stainless steel rack for PBV models	129
Z-RAIV	Rejilla inox acanalada para modelos PBV / Slotted stainless steel rack for PBV models	114

ECO-LINE

ECO-LINE

**Más rendimiento,
menos espacio.**

*More performance,
less space.*





Cocinas encimeras tradicionales

Traditional cooktops



ELE-31 G



ELE-62 EM



Detalle de la placa (ELPF) sobre rejilla de fundición
Detail of the plate (ELPF) on cast iron rack

- ▶ Medidas comunes: 50 cm de profundidad x 24 cm de altura.
- ▶ Fuegos de 6kW y Ø 120mm. ▶ Rejillas de fundición. ▶ Cuerpo del fogón de acero al carbono y corona de latón.
- ▶ Válvulas de gas con termopar de seguridad.
- ▶ Diámetro de placa: 220mm. ▶ Potencia placa: 2.600w. ▶ Placas con limitador de temperatura.
- ▶ **Plancha sobre fogón ELPF:** Placa de 24x27,5cm de superficie útil en acero rectificando ajustable a la rejilla del fogón.

- ▶ Common dimensions: 50 cm depth x 24 height.
- ▶ Burners of 6 kW and Ø 120 mm. ▶ Cast iron racks. ▶ Body of the ring in carbon steel and brass crown.
- ▶ Gas valves with safety thermocouple.
- ▶ Plate diameter: 220 mm - Power plate: 2,600w. ▶ Plates with temperature limiter.
- ▶ **Griddle on ring ELPF:** Plate with useful area of 24x27.5 cm in ground steel adjustable to the burner rack.

Modelos ELE-EM: Monofásico 230V 50/60Hz
Models ELE-EM: Single-phase S230V 50/60Hz

Modelos	Medidas exteriores	Nº fuegos	Kg neto	kW	Kcal/h	Medidas embalaje	Kg bruto	m ³	€
ELE-31G	30x50x24h	1	11	6	5.100	37x64x35h	13	0,08	490
ELE-62G	60x50x24h	2	18	12	10.200	66x64x35h	24	0,15	839
ELE-93G	90x50x24h	3	30	18	15.300	96x64x35h	34	0,22	1.132
ELE-31EM	30x50x24h	1	8	2,6	-	37x64x35h	10	0,08	459
ELE-62EM	60x50x24h	2	15	5,2	-	66x64x35h	18	0,15	710
ELE-93EM	90x50x24h	3	22	7,8	-	96x64x35h	26	0,22	1.009
Accesorios - Accessories									
ELPF	35x26,5x1h	-	6,5	-	-	61x42x6,5h	7	0,01	200
Y-533009200	27x27	-	-	-	-	28x28	-	-	42

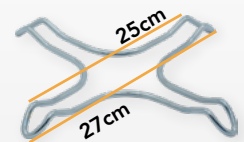

Y-533009200
Rejilla reducción fogón
Stove reduction grill

Situación conexión
Connection situation

- Gas 1/2"
- Eléctrico

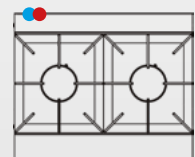

Cocinas Wok

Wok cooktop



NUEVO
NEW



Aro wok + sartén wok
Wok ring + wok pan



Detalle embutición centrador aro
Detail ring centring device inlay



ELW-41G

► Medidas comunes: 50cm profundidad x 24cm de altura. ► Construido totalmente en acero inoxidable. ► Quemador atmosférico de 12kW de gran rendimiento. ► Encimera de acero inoxidable reforzada por tirantes internos. ► Fuego de llama vertical dirigida al centro de la sartén wok, que realiza un abanico de llama por toda la superficie, consiguiendo una temperatura extrema e idónea para este tipo de cocción. ► Equipados con válvulas de gas con termopar de seguridad y llama piloto. ► Aro wok en acero pavonado negro.

► Common dimensions: 50 cm depth x 24 height. ► Built entirely of stainless steel. ► High-performance atmospheric burners. ► Stainless steel worktop reinforced by internal braces. ► Vertical flame burners directed at the centre of the wok pan, which spreads the heat across the entire surface, achieving an extreme temperature that is ideal for this type of cooking. ► Equipped with gas valves with safety thermocouple and pilot flame. ► Wok rings in black blued steel. Black ABS controls.

Situación conexión

Connection situation

● Gas 1/2"

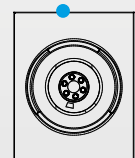

Modelos	Medidas exteriores	Nº fuegos	Kg neto	kW	Kcal/h	Medidas embalaje	Kg bruto	m ³	€
ELW-41 G	40x50x24h	1	13,5	12	10.320	42x64x42h	15,5	0,11	1.144

NUEVO
NEW



Cocinas de inducción

Induction cooktops



Detalle del cristal
Detail of glass

ELI-41 EM

- ▶ Medidas comunes: 50 cm de profundidad x 24 cm de altura. ▶ 1 zona de trabajo. ▶ Manejo sencillo e intuitivo. ▶ Ventiladores insonoros ▶ Medición continua de la temperatura. ▶ Potencia constante durante la cocción. ▶ Varios niveles de potencia. ▶ Cristal superior de 4mm de espesor. ▶ Función de temporizador.

- ▶ Common dimensions: 50 cm depth x 24 height. ▶ 1 work area. ▶ Simple and intuitive operation. ▶ Silent fans. ▶ Continuous temperature measurement using the Soft Touch panel. ▶ Constant power throughout cooking. ▶ Various power levels. ▶ 4 mm thick top glass. ▶ Timer function.



Monofásico 230V 50/60 Hz
Single-phase 230V 50/60 Hz

Situación conexión
Connection situation

● Eléctrico

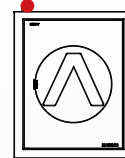

Modelos	Medidas exteriores	Kg neto	kW	Medidas embalaje	Kg bruto	m ³	€
ELI-41EM	40x50x24h	10	3,5	42x64x42h	12	0,11	1.694



Planchas Griddles

Cromo duro - Acero rectificado - Pavonado
Hard chrome - Rectified steel - Blued



ELP-62 GCN



ELP-62 GN

Planchas Griddles

Cromo duro - Acero rectificado - Pavonado
Hard chrome - Rectified steel - Blued



NUEVO
NEW



Cajón recolector
Collection box



ELP-62 EMRN

- ▶ Medidas comunes: 50 cm de profundidad x 24 cm de altura. ▶ Bandeja recolectora y cajón situado en el frontal de fácil limpieza.
 - ▶ **ELP-N:** Placa acero pavonado en negro de 8mm de espesor. ▶ **ELP-R:** Placa de acero rectificado de 12mm de espesor.
 - ▶ **ELP-CN:** Placa de cromo duro de 12 mm de espesor.
 - ⚡ **Modelos ELP-GN/ELP-GR:** Válvulas de gas con dos intensidades de calor y termopar de seguridad.
 - ⚡ **Modelos ELP-GCN:** Válvulas termostáticas.
 - ⚡ **Todos los modelos:** Resistencias blindadas en acero inoxidable. ▶ Termostatos con conmutador de encendido.
-
- ▶ Common dimensions: 50 cm depth x 24 height. ▶ Collecting tray and drawer located in the front of easy cleaning.
 - ▶ **ELP-N:** Black blued steel plate 8 mm thick. ▶ **ELP-R:** 12 mm thick rectified steel plate.
 - ▶ **ELP-CN:** Hard chrome plate of 12 mm thick.
 - ⚡ **Models ELP-GN/ELP-GR:** Gas valves with two heat intensities and safety thermocouple.
 - ⚡ **ELP-GR models:** Thermostatic valves.
 - ⚡ **All models:** Stainless steel armoured resistors. ▶ Thermostats with power switch.

Modelos	Medidas exteriores	Superficie útil	Kg neto	kW	Kcal/h	Medidas embalaje	Kg bruto	m ³	€
ELP-31GN	30x50x24h	28x43	18	4,1	3.528	37x64x35h	20	0,08	584
ELP-62GN	60x50x24h	58x43	31	8,2	7.000	66x64x46h	38	0,19	789
ELP-93GN	90x50x24h	88x43	45	12,3	10.584	96x64x48h	54	0,29	1.061
ELP-31GRN	30x50x24h	29x43,5	20	4,1	3.528	37x64x35h	22	0,08	736
ELP-62GRN	60x50x24h	59x43,5	36	8,2	7.000	66x64x46h	43	0,19	986
ELP-93GRN	90x50x24h	89x43,5	53	12,3	10.584	96x64x48h	62	0,29	1.366
ELP-31GCN	30x50x24h	29x43,5	20	4,1	3.528	37x64x35h	22	0,08	800
ELP-62GCN	60x50x24h	59x43,5	36	8,2	7.000	66x64x46h	43	0,19	1.209
ELP-93GCN	90x50x24h	89x43,5	53	12,3	10.584	96x64x48h	62	0,29	1.628
ELP-31EMN	30x50x24h	28x43	19	2	-	37x64x35h	20	0,08	584
ELP-62EMN	60x50x24h	58x43	34	4	-	66x64x46h	38	0,19	854
ELP-93EMN	90x50x24h	88x43	49	6	-	96x64x48h	54	0,29	1.095
ELP-31EMRN	30x50x24h	29x43,5	21	2	-	37x64x35h	22	0,08	767
ELP-62EMRN	60x50x24h	59x43,5	39	4	-	66x64x46h	43	0,19	1.084
ELP-93EMRN	90x50x24h	89x43,5	57	6	-	96x64x48h	62	0,29	1.432
ELP-31EMCN	30x50x24h	29x43,5	21	2	-	37x64x35h	22	0,08	796
ELP-62EMCN	60x50x24h	59x43,5	39	4	-	66x64x46h	43	0,19	1.201
ELP-93EMCN	90x50x24h	89x43,5	57	6	-	96x64x48h	62	0,29	1.578

EN DOTACIÓN - INCLUDED

Muestra de desengrasante en modelos de cromo duro.
Degreaser sample on hard chrome models.



Modelos ELP-EM
Monofásico 230V 50/60Hz
Models ELP-EM
Single-phase 230V 50/60Hz

Situación conexión
Connection situation
● Gas 1/2" ● Eléctrico

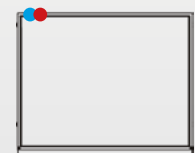

NUEVO
NEW



Barbacoas a gas

Acero inoxidable & pavonadas - Stainless steel & Blued



ELBI-62GN



Cajón recolector
Collection box



ELB-62GN



Rejillas regulables en altura trasera
Rear height adjustable racks

- Medidas comunes: 50 cm de profundidad x 24 cm de altura. ► Bandeja recolectora y cajón situado en el frontal de fácil limpieza. ► Calefacción por sistema de refracción por piedra lávica. ► Baterías de quemadores tubulares esmaltados vitrificados al fuego. ► Zonas de trabajo independientes. ► Válvulas de gas con termopar de seguridad.

Rejillas: Acanaladas y regulables en altura trasera.

- Common dimensions: 50 cm depth x height 24 ► Fat collector trays for easy removal for cleaning. ► Heating by refractive system by lava stone ► Batteries of fire vitrified enamel tubular burners ► Independent work areas. ► Gas valves with safety thermocouple.

Racks: Grooved and adjustable in the rear height.

Modelos ELBI: Rejilla de acero inoxidable / Modelos ELB: Rejilla de acero pavonado.
ELBI models: Stainless steel rack / ELB models: Blued steel rack.

Modelos	Medidas exteriores	Superficie útil	Kg neto	kW	Kcal/h	Medidas embalaje	Kg bruto	m ³	€
ELB-31GN	30x50x24h	26x42,5	21	6,5	5.590	37x64x35h	23	0,08	855
ELB-62GN	60x50x24h	53x42,5	37	13	11.180	66x64x46h	44	0,19	1.231
ELB-93GN	90x50x24h	79x42,5	54	19,5	16.770	96x64x48h	64	0,29	1.660
ELBI-31GN	30x50x24h	26x42,5	21	6,5	5.590	37x64x35h	23	0,08	885
ELBI-62GN	60x50x24h	53x42,5	37	13	11.180	66x64x46h	44	0,19	1.287
ELBI-93GN	90x50x24h	79x42,5	54	19,5	16.770	96x64x48h	64	0,29	1.744

Situación conexión
Connection situation
● Gas 1/2"

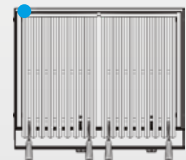

Barbacoas eléctricas

Electric grills



Resistencias
Resistances



Grifo de vaciado
Drainage tap



ELB-82EM

EN DOTACIÓN - INCLUDED

Rasqueta barbacoa
Barbecue scraper

► Medidas comunes: 50 cm de profundidad x 24 cm de altura. ► Regulador de energía de 6 posiciones. ► Resistencias blindadas de acero inoxidable. ► Cabezal de resistencia y peto perimetral de acero inoxidable de fácil extracción para su limpieza. ► Dotada de grifo de vaciado. ► Cubeta contenedora de agua, que elimina el 80% de humo y llama. ► Zonas de trabajo independientes.

► Common dimensions: 50 cm depth x 24 height. ► Energy regulator with 6 positions. ► Stainless steel shielded heating elements. ► Heating element header easily removable for cleaning. ► Fitted with drainage tap. ► Water container basin, that eliminates 80% of smoke and flames. ► Stainless steel perimeter panel. ► Separate working areas.

 **Monofásico 230V 50/60Hz**
Single-phase 230V 50/60 Hz

Modelos	Medidas exteriores	Superficie útil	Kg neto	kW	Medidas embalaje	Kg bruto	m ³	€
ELB-41EM	40x50x24h	33x35	11	2,2	42x64x42h	13	0,11	1.202
ELB-62EM	60x50x24h	49x35	16	3,3	65x67x42h	19	0,18	1.527
ELB-82EM	80x50x24h	65x35	21	4,4	95x67x42h	25	0,27	1.919
Z-C-3	-	-	-	-	-	-	-	15

Situación conexión
Connection situation
● Eléctrico

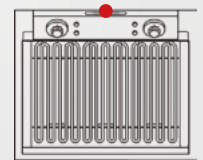



Paellero

Paella pan



ELPA-41G



Quemador estrella
Star burner

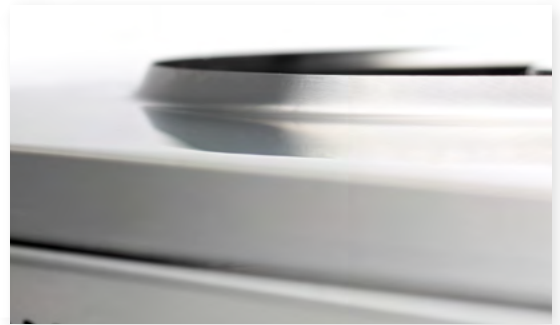

Detalle embutición centrador soporte paella
Detail paella support centring device inlay

- ▶ Medidas comunes: 50 cm de profundidad x 24 cm de altura.
- ▶ Válvulas de gas con termopar de seguridad y dos intensidades de calor.
- ▶ Calor uniforme en toda la superficie de la paella.
- ▶ Quemador de estrella de gran rendimiento esmaltado vitrificado al fuego.
- ▶ **En dotación paella Ø 38cm en acero pulido (modelos ELPA-41G y ELPA-82G) paella Ø 50cm (modelo ELPA-61G).**

- ▶ Common dimensions: 50 cm depth x 24 cm height
- ▶ Gas valves with safety thermocouple and two heat intensities
- ▶ Even heat across the entire surface of the paella
- ▶ Fire vitrified enamelled high performance star burner.
- ▶ **Included paella pan Ø 38 cm in polished steel (models ELPA-41G and ELPA-82G) paella pan Ø 50 cm (model ELPA-61G).**

EN DOTACIÓN - INCLUDED

Modelos ELPA-41 - ELPA-82
paella Ø 38cm
Modelo ELPA-61
paella Ø 50cm

Models ELPA-41 - ELPA-82
paella pan Ø 38cm
Model ELPA-61
paella pan Ø 50cm

Modelos	Medidas exteriores	Diámetro paella	Kg neto	kW	Kcal/h	Medidas embalaje	Kg bruto	m ³	€
ELPA-41G	40x50x24h	Ø 38	11	5,5	4.675	42x64x42h	13	0,11	648
ELPA-61G	60x50x24h	Ø 50	15	5,5	4.675	66x64x35h	18	0,15	739
ELPA-82G	80x50x24h	Ø38 + Ø38	19	11	9.350	96x64x35h	23	0,22	1.145
Paella Ø 38	Z06599000001	Ø38	-	-	-	-	-	-	23
Paella Ø 50	Z06599000002	Ø50	-	-	-	-	-	-	37

Situación conexión

Connection situation

- Gas 1/2"

Freidoras eléctricas

Electric fryers



Cesta en acero inoxidable
Basket made of stainless steel



Grifo de vaciado
Drainage tap



ELF-31 EM



ELF-62 EMG

EN DOTACIÓN - INCLUDED

Tapa y cesta
Lid and basket

- ▶ Medidas comunes: 50 cm de profundidad x 24 cm de altura.
- ▶ **ALTO RENDIMIENTO.** ▶ Resistencia blindada en acero inoxidable.
- ▶ Cabezal de resistencia de fácil extracción para su limpieza.
- ▶ Los modelos **EMG** disponen de grifo de vaciado.
- ▶ Termostato de seguridad incorporado.
- ▶ Regulación de la temperatura a través del termostato de trabajo.

- ▶ Common dimensions: 50 cm depth x 24 height.
- ▶ **HIGH PERFORMANCE.** ▶ Heating element header easily removable for cleaning.
- ▶ Stainless steel shielded heating element.
- ▶ **EMG** models have a drain tap.
- ▶ Built-in safety thermostat.
- ▶ Temperature regulation with the work thermostat.

Monofásico 230V 50/60Hz
Single-phase 230V 50/60 Hz

Modelos	Medidas exteriores	Capacidad litros/aceite	Medidas Cesta	Kg neto	kW	Medidas embalaje	Kg bruto	m ³	€
ELF-31 EM	30x50x24h	8	23,5x21x10h	9,5	4,5	33x64x40h	11,5	0,08	655
ELF-62 EM	60x50x24h	8+8	(23,5x21x10h)x2	18	9	65x67x42h	21	0,18	1.044
ELF-31 EMG	30x50x24h	8	23,5x21x10h	9,5	4,5	33x64x40h	11,5	0,08	725
ELF-62 EMG	60x50x24h	8+8	(23,5x21x10h)x2	18	9	65x67x42h	21	0,18	1.228

Situación conexión
Connection situation

● Eléctrico

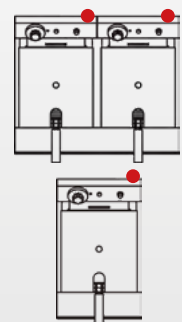



Creperas

Crêpe makers



ELC-82G



Embutición protectora del interior
Inlay to protect inside

- ▶ Medidas comunes: 50 cm de profundidad x 24 cm de altura. ▶ Diámetro útil de la placa: 350mm. ▶ Calor uniforme en toda la superficie de la placa. ▶ Placa de acero rectificando de 15mm de espesor. ◊ Quemador de estrella de gran rendimiento. ▶ Válvulas de gas con termopar de seguridad. ⚡ Resistencia blindada en acero inoxidable. ▶ Control de la temperatura a través del termostato.
- ▶ Common dimensions: 50 cm depth x 24 height. ▶ Useful diameter of the plate: 350 mm. ▶ Even heat on the entire plate. ▶ Blued steel plate 15 mm thick. ◊ High performance star burner. ▶ Gas valves with safety thermocouple. ⚡ Stainless steel shielded heating element.

Modelos ELC-EM - Monofásico 230V 50/60Hz
ELC-EM Models - Single-phase 230V 50/60Hz

Modelos	Medidas exteriores	Diámetro placa	Kg neto	kW	Kcal/h	Medidas embalaje	Kg bruto	m ³	€
ELC-41 G	40x50x24h	∅ 35	19	5,5	4.675	42x64x41h	22	0,11	702
ELC-82 G	80x50x24h	∅ 35 + ∅ 35	35	11	9.350	96x64x48h	45	0,29	1.207
ELC-41 EM	40x50x24h	∅ 35	20	2,4	-	42x64x41h	23	0,11	701
ELC-82 EM	80x50x24h	∅ 35 + ∅ 35	38	4,8	-	96x64x48h	48	0,29	1.173

Situación conexión
Connection situation

● Gas 1/2" ● Eléctrico

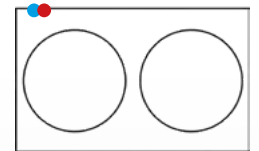

Baño maría

Electric bain marie



ELBM-31 EM

- ▶ Medidas comunes: 50cm de profundidad x 24 cm de altura. ▶ Termostato de trabajo 30-90°C. ▶ Dotado de grifo de vaciado. ▶ Cubetas **NO INCLUIDAS**. ▶ Resistencia blindada en acero inoxidable. ▶ Plancha inox perforada en el interior.
- ▶ Common dimensions: 50 cm depth x 24 height ▶ Work thermostat 30-90 °C ▶ Equipped with drain tap ▶ Basins **NOT INCLUDED** ▶ Stainless steel shielded heating element. ▶ Perforated stainless steel plate on the inside.

Situación conexión
Connection situation

● Eléctrico

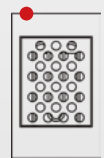

Modelo	Medidas exteriores	Medidas cuba	Kg neto	kW	Medidas embalaje	Kg bruto	m ³	€
ELBM-31 EM	30x50x24h	GN 1/2 x 15h	8	0,9	37x64x35h	10	0,08	687

Monofásico 230V 50/60 Hz
Single-phase 230V 50/60 Hz

Fregadero y muebles neutros

Sink and neutral working envelopes



Vista sifón
View trap



ELFR-6

- ▶ Medidas comunes: 50 cm de profundidad x 24 cm de altura.
- ▶ Construido totalmente en acero inoxidable.
- ▶ Modulables con aparatos de cocción Serie ECO-LINE, montado sobre mesas ELM (página 46) **NO INCLUIDA**.
- ▶ **ELFR:** Cubeta con rebosadero integrado y tapón.
- ▶ Grifo monomando con maneta gerontológica (diseño según normativa) ▶ **En dotación: Sifón tipo botella.**

- ▶ Common dimensions: 50 cm depth x 24 height.
- ▶ Entirely built in stainless steel ▶ Basin with built-in overflow and plug. ▶ Moduable with ECO-LINE Series cooking appliances, assembled on ELM tables (page 46) **NOT INCLUDED**.
- ▶ **ELFR:** bucket with integrated overflow and plug.
- ▶ Mixing tap with gerontological handle (design according to regulations). ▶ **Included: Bottle type trap.**



ELN-4

Modelos	Medidas exteriores	Medidas cubeta	Kg neto	Medidas embalaje	Kg bruto	m ³	€
ELFR-4	40x50x24h	29x35x14h	9	42x64x42h	12	0,11	880
ELFR-6	60x50x24h	35x29x14h	11	66x64x35h	14	0,15	939
ELN-3	30x50x24h	-	5	37x64x35h	9	0,08	260
ELN-4	40x50x24h	-	7	42x64x42h	12	0,11	319
ELN-6	60x50x24h	-	9	66x64x35h	12	0,15	379

EN DOTACIÓN - INCLUDED

Sifón tipo botella en los fregaderos.
Bottle type trap in sinks.



Equipamiento

Equipment

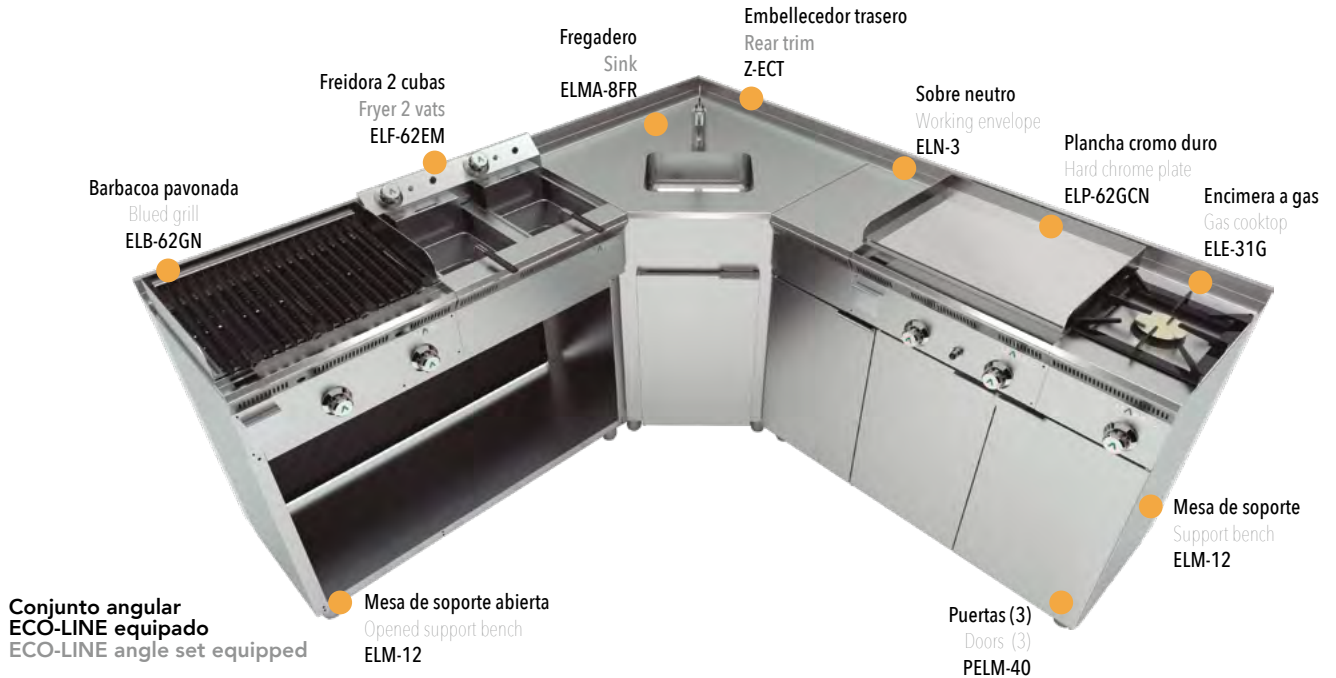

► Mesas construidas totalmente en acero inoxidable. ► Desmontables. ► Altura del equipo: 96,5 cm.

► Patas graduables en altura. ► **PUERTAS OPCIONALES.** ► **RUEDAS OPCIONALES.**

► Tables entirely built in stainless steel. ► Detachable. ► Equipment height: 96.5 cm. ► Height-adjustable legs.

► **TABLES WITH REAR COVER INCLUDED.** ► **OPTIONAL DOORS.** ► **OPTIONAL WHEELS.**

Embellecedores

Trims



Z-ECT

Emb. trasero · 199€/metro lineal
Rear Trim €199/linear metre



ECLT

Emb. lateral TOP · 46€/unidad
Rear Trim TOP €46/unit

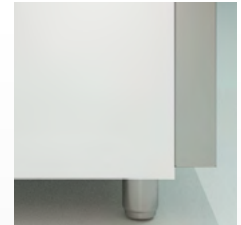

ECL

Emb. lateral · 69€/unidad
Side trim · 69€ / unit

	Modelos	Medidas exteriores	Kg neto	Compatible con...	Medidas embalaje	Kg bruto	m ³	€	
Mesas Table	ELM-6N	60x44x74h	13,5	-	68x56x12h	17,5	0,05	460	
	ELM-8N	80x44x74h	15,5	-	98x56x12h	19,5	0,07	561	
	ELM-9N	90x44x74h	17	-	98x56x12h	21	0,07	591	
	ELM-10N	100x44x74h	19,5	-	128x56x12h	22,5	0,09	616	
	ELM-12N	120x44x74h	21,5	-	128x56x12h	25,5	0,09	667	
	ELM-15N	150x44x74h	24	-	158x56x12h	29	0,1	804	
	Puertas Doors	PELM-40	40x65x1,5h	4	-	68,5x52x7h	4,7	0,02	175
		PELM-50	50x65x1,5h	4,9	-	68,5x52x7h	5,6	0,02	187
		PELM-60	60x65x1,5h	5,8	ELM-6N	68,5x52x7h	6,5	0,02	233
	Ruedas wheels	RMEL	∅ 60x24; 8,2h	0,57	ELM/ELMA	-	-	-	25
RMELF		∅ 60x24; 8,2h	0,72	ELM/ELMA	-	-	-	40	
Angular Angular	ELMA-6	60x60x95h	33	-	68x88x111h	-	0,51	1.208	
	ELMA-8	80x80x95h	46	-	88x88x111h	-	0,86	1.379	
	ELMA-8FR	80x80x95h	50	-	88x88x111h	-	0,86	1.896	

Mesas con tapa trasera incluida.
Tables with rear cover included.

PELM 60 = PELM-50 + panel

FREGADERO ELMA-8FR: Cubeta con rebosadero integrado, grifo y tapón, de medidas 35x29x14h
SINK ELMA-8FR: Sink with overflow built-in, tap and plug, with dimensions 35x29x14h

GRIDDLES

PLANCHAS

Profesionales y económicas.

Professional and economical.





Serie Novo-Crom

Cromo duro - Hard chrome



NC-40N



Tren de chispas
Multi spark

- ▶ Planchas profesionales construidas completamente en acero inoxidable 18/8.
- ▶ **Placa de cromo duro** de 15mm de espesor.
- ▶ Disponen de cajón recolector en el frontal de la máquina (Modelo 100: 2 cajones).
- ▶ **Semi-ranuradas:** Superficie ranurada de 30cm de ancho, excepto modelos 100 que son 40cm.
- ♠ Válvulas termostáticas. ▶ Encendido por tren de chispas a batería.

- ▶ Professional griddles entirely built in 18/8 stainless steel.
- ▶ **Hard chrome plate** 15 mm thick.
- ▶ They have a collection drawer on the front of the machine (Model 100: 2 drawers).
- ▶ **Semi-slotted:** Slotted surface with width of 30 cm, except models 100 which are 40 cm wide.
- ♠ Thermostatic valves. ▶ Piezoelectric ignition.

Tipo de placa
Type of plate



NC-N
Placa lisa
Smooth plate



NCR-N
Placa semi-ranurada
Half-slotted plate



NCRR-N
Placa ranurada
Slotted plate

EN DOTACIÓN - INCLUDED

- Espátula
- Muestra de desengrasante
- Modelos ranurados:**
Espátula ranurada
- All models - Spatula**
Degreaser sample
- Grooved models:**
Grooved spatula

Modelos	Medidas exteriores	Superficie útil	Kg neto	kW	Kcal/h	Medidas embalaje	Kg bruto	m ³	€
NC-40N	40x44x18h	39,5x43	28	4,1	3.526	51x53x25h	30	0,07	1.036
NC-60N	60x44x18h	59,5x43	40	8,2	7.052	64x53x37h	46	0,12	1.455
NC-80N	80x44x18h	79,5x43	54	12,3	10.528	84x53x37h	60	0,16	1.816
NC-100N	100x44x18h	99,5x43	64	14,9	12.814	104x53x37h	73	0,20	2.083
NCR-60N	60x44x18h	59,5x43	40	8,2	7.052	64x53x37h	46	0,12	1.637
NCR-80N	80x44x18h	79,5x43	54	12,3	10.528	84x53x37h	60	0,16	1.978
NCR-100N	100x44x18h	99,5x43	64	14,9	12.814	104x53x37h	73	0,20	2.262
NCRR-40N	40x44x18h	39,5x43	28	4,1	3.526	51x53x25h	30	0,07	1.383
NCRR-60N	60x44x18h	59,5x43	40	8,2	7.052	64x53x37h	46	0,12	1.800
NCRR-80N	80x44x18h	79,5x43	54	12,3	10.528	84x53x37h	60	0,16	2.150
NCRR-100N	100x44x18h	99,5x43	64	14,9	12.814	104x53x37h	73	0,20	2.499

Situación conexión
Connection situation

- Gas 1/2"



Serie Novo-Crom

Cromo duro - Hard chrome

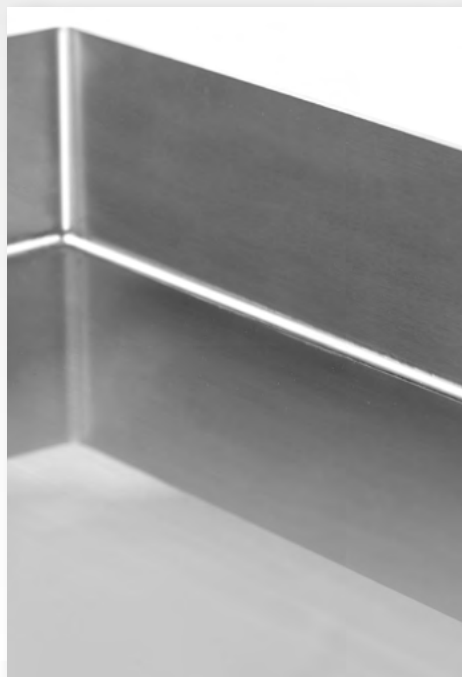

Soldadura hermética
Hermetic welding



NCEM-60N

- ▶ Planchas profesionales construidas completamente en acero inoxidable 18/8. ▶ **Placa de cromo duro** de 15mm de espesor.
- ▶ Disponen de cajón recolector en el frontal de la máquina (Modelo 100: 2 cajones).
- ▶ **Semi-ranuradas:** Superficie ranurada de 30cm de ancho, excepto modelos 100 que son 40cm.
- ⚡ Termostatos con conmutador de encendido. ▶ Resistencias blindadas en acero inox.

- ▶ Professional griddles entirely built in 18/8 stainless steel ▶ **Hard chrome griddle** 15 mm thick.
- ▶ They have a collection drawer on the front of the machine (Model 100: 2 drawers).
- ▶ **Semi-slotted:** Slotted surface with width of 30 cm, except models 100 which are 40 cm wide. **Option: complete slotted.**
- ⚡ Thermostats with ignition switch. ▶ Stainless steel shielded heating element.

EN DOTACIÓN - INCLUDED

- Espátula
- Muestra de desengrasante
- Modelos ranurados:**
- Espátula ranurada
- All models - Spatula**
- Degreaser sample
- Grooved models:**
- Grooved spatula

Tipo de placa
Type of plate



NCEM
Placa lisa
Smooth plate



NCREM
Placa semi-ranurada
Half-slotted plate



NCRREM
Placa ranurada
Slotted plate

Modelos	Medidas exteriores	Superficie útil	Kg neto	kW	Medidas embalaje	Kg bruto	m ³	€
NCEM-40N	40x44x18h	39,5x43	29	2,6	51x53x25h	31	0,07	1.131
NCEM-60N	60x44x18h	59,5x43	43	4	64x53x37h	49	0,12	1.534
NCEM-80N	80x44x18h	79,5x43	57	5,3	84x53x37h	63	0,16	1.899
NCEM-100N	100x44x18h	99,5x43	67	6	104x53x37h	75	0,20	2.261
NCREM-60N	60x44x18h	59,5x43	43	4	64x53x37h	49	0,12	1.717
NCREM-80N	80x44x18h	79,5x43	57	5,3	84x53x37h	63	0,16	2.060
NCREM-100N	100x44x18h	99,5x43	67	6	104x53x37h	75	0,20	2.441
NCRREM-40N	40x44x18h	39,5x43	29	2,6	51x53x25h	31	0,07	1.383
NCRREM-60N	60x44x18h	59,5x43	43	4	64x53x37h	49	0,12	1.880
NCRREM-80N	80x44x18h	79,5x43	57	5,3	84x53x37h	63	0,16	2.241
NCRREM-100N	100x44x18h	99,5x43	67	6	104x53x37h	75	0,20	2.680



Monofásico 230 V 50/60Hz
Single-phase 230 V 50/60Hz

Situación conexión
Connection situation
● Eléctrico / Electric





Serie Novo-Snack

Rectificada - Rectified



NSR-80N



Ranuras
Slots

- ▶ Planchas profesionales construidas completamente en acero inoxidable 18/8. ▶ **Placa de acero rectificad**o de 15mm de espesor.
- ▶ Disponen de cajón recolector en el frontal de la máquina (Modelo 100: 2 cajones).
- ▶ **Semi-ranuradas:** Superficie ranurada de 30cm de ancho, excepto modelos 100 que son 40cm.
- ◊ Válvulas de gas con dos intensidades de calor y termopar de seguridad. ▶ Encendido por tren de chispas a batería.
- ▶ Professional griddles entirely built in 18/8 stainless steel ▶ **Hard chrome griddle** 15 mm thick.
- ▶ They have a collection drawer on the front of the machine (Model 100: 2 drawers).
- ▶ **Semi-slotted:** Slotted surface with width of 30 cm, except models 100 which are 40 cm wide. **Option: complete slotted.**
- ◊ Gas valves with two heat intensities and safety thermocouple. ▶ Piezoelectric ignition.

Tipo de placa
Type of plate



NS-N
Placa lisa
Smooth plate



NSR-N
Placa semi-ranurada
Half-slotted plate



NSRR-N
Placa ranurada
Slotted plate

EN DOTACIÓN - INCLUDED

- Espátula pequeña
- Modelos ranurados:**
- Espátula ranurada
- All models - Small spatula
- Grooved models:
- Grooved spatula

Situación conexión
Connection situation

- Gas 1/2"



Modelos	Medidas exteriores	Superficie útil	Kg neto	kW	Kcal/h	Medidas embalaje	Kg bruto	m ³	€
NS-40N	40x44x18h	39,5x43	28	4,1	3.526	51x53x25h	30	0,07	709
NS-60N	60x44x18h	59,5x43	40	8,2	7.052	64x53x37h	46	0,12	896
NS-80N	80x44x18h	79,5x43	54	12,3	10.528	84x53x37h	60	0,16	1.086
NS-100N	100x44x18h	99,5x43	64	14,9	12.814	104x53x37h	73	0,20	1.346
NSR-60N	60x44x18h	59,5x43	40	8,2	7.052	64x53x37h	46	0,12	1.044
NSR-80N	80x44x18h	79,5x43	54	12,3	10.528	84x53x37h	60	0,16	1.215
NSR-100N	100x44x18h	99,5x43	64	14,9	12.814	104x53x37h	73	0,20	1.505
NSRR-40N	40x44x18h	39,5x43	28	4,1	3.526	51x53x25h	30	0,07	977
NSRR-60N	60x44x18h	59,5x43	40	8,2	7.052	64x53x37h	46	0,12	1.245
NSRR-80N	80x44x18h	79,5x43	54	12,3	10.528	84x53x37h	60	0,16	1.456
NSRR-100N	100x44x18h	99,5x43	64	14,9	12.814	104x53x37h	73	0,20	1.746

Serie Novo-Snack

Rectificada - Rectified



Cajón recolector
Collection drawer



NSEM-80N

- ▶ Planchas profesionales construidas completamente en acero inoxidable 18/8. ▶ **Placa de acero rectificad**o de 15mm de espesor.
 - ▶ Disponen de cajón recolector en el frontal de la máquina (Modelo 100: 2 cajones).
 - ▶ **Semi-ranuradas:** Superficie ranurada de 30cm de ancho, excepto modelos 100 que son 40cm.
 - ⚡ Termostatos con conmutador de encendido. ▶ Resistencias blindadas en acero inox.
-
- ▶ Professional griddles entirely built in 18/8 stainless steel ▶ **Hard chrome griddle** 15 mm thick.
 - ▶ They have a collection drawer on the front of the machine (Model 100: 2 drawers).
 - ▶ **Semi-slotted:** Slotted surface with width of 30 cm, except models 100 which are 40 cm wide. **Option: complete slotted.**
 - ⚡ Thermostats with ignition switch. ▶ Stainless steel shielded heating element.

Tipo de placa
Type of plate



NSEM
Placa lisa
Smooth plate



NSREM
Placa semi-ranurada
Half-slotted plate



NSRREM
Placa ranurada
Slotted plate

EN DOTACIÓN - INCLUDED

Espátula pequeña
Modelos ranurados:
Espátula ranurada
All models - Small spatula
Grooved models:
Grooved spatula

Modelos	Medidas exteriores	Superficie útil	Kg neto	kW	Medidas embalaje	Kg bruto	m ³	€
NSEM-40N	40x44x18h	39,5x43	29	2,6	51x53x25h	31	0,07	895
NSEM-60N	60x44x18h	59,5x43	43	4	64x53x37h	49	0,12	1.029
NSEM-80N	80x44x18h	79,5x43	57	5,3	84x53x37h	63	0,16	1.259
NSEM-100N	100x44x18h	99,5x43	67	6	104x53x37h	75	0,20	1.526
NSREM-60N	60x44x18h	59,5x43	43	4	64x53x37h	49	0,12	1.177
NSREM-80N	80x44x18h	79,5x43	57	5,3	84x53x37h	63	0,16	1.400
NSREM-100N	100x44x18h	99,5x43	67	6	104x53x37h	75	0,20	1.696
NSRREM-40N	40x44x18h	39,5x43	29	2,6	51x53x25h	31	0,07	1.165
NSRREM-60N	60x44x18h	59,5x43	43	4	64x53x37h	49	0,12	1.349
NSRREM-80N	80x44x18h	79,5x43	57	5,3	84x53x37h	63	0,16	1.635
NSRREM-100N	100x44x18h	99,5x43	67	6	104x53x37h	75	0,20	1.926



Monofásico 230 V 50/60 Hz
Single-phase 230 V 50/60 Hz

Situación conexión
Connection situation
● **Eléctrico / Electric**

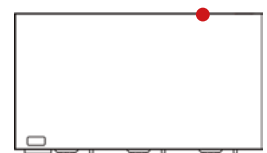



Serie Novo-Foc

Cromo duro & Rectificada - Hard chrome & rectified



NCF-60N



Detalle fogón de 6 kW
Detail 6 kW's ring

► Planchas profesionales construidas completamente en acero inoxidable 18/8. ► **Placa de cromo duro** de 15 mm de espesor (modelo NCF) o **placa rectificada** de 15mm de espesor (modelo NSF). ► Disponen de cajón recolector en el frontal de la máquina.
 🔥 Encendido por tren de chispas a batería. **NCF:** Válvulas termostáticas. **NSF:** Válvulas de gas con termopar de seguridad.
 🔊 FOGÓN: 6 Kw de potencia Ø 120mm. ► Encendido por tren de chispas a batería.
OPCIÓN: Rejilla reductora (Z-533009200)

► Professional griddles entirely built in 18/8 stainless. ► **Hard chrome griddle** 15 mm thick (Model NCF) or **Rectified griddle** 12 mm thick (Model NSF). ► They have a collection drawer on the front of the machine.
 🔥 Ignition by battery piezoelectric. **NCF:** Thermostatic valves. **NSF:** Gas valves with safety thermocouple.
 🔊 RING: 6 kW of power and Ø 120 mm. ► Ignition by battery piezoelectric. **OPTION:** Reducer rack (Z-533009200)

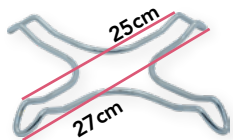

Y-533009200
Grille de réduction de feu
Stove reduction grill

Tipo de placa
Type of plate



NCF/NSF
Placa lisa
Smooth plate



NCFR/NSFR
Placa semi-ranurada
Half-slotted plate

EN DOTACIÓN - INCLUDED

Espátula pequeña
Modelos de cromo duro:
 Muestra de desengrasante
 Small spatula
Hard chrome models:
 Sample of degreaser

Modelos	Medidas exteriores	Superficie útil	Kg neto	kW	Kcal/h	Medidas embalaje	Kg bruto	m ³	€
NCF-60N	90,5x44x18h	59,5x43	51	14,	12.212	104x53x37h	58	0,20	1.938
NSF-60N	90,5x44x18h	59,5x43	51	14,2	12.212	104x53x37h	58	0,20	1.343
NCFR-60N	90,5x44x18h	59,5x43	51	14,2	12.212	104x53x37h	58	0,20	2.095
NSFR-60N	90,5x44x18h	59,5x43	51	14,2	12.212	104x53x37h	58	0,20	1.477
Y-533009200	27x27	25x25	-	-	-	28x28	0,2	-	42

Situación conexión
 Connection situation
 ● Gas 1/2"

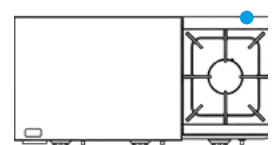

Serie Sandwichera

Adaptable en todos los modelos
Adaptable on all models

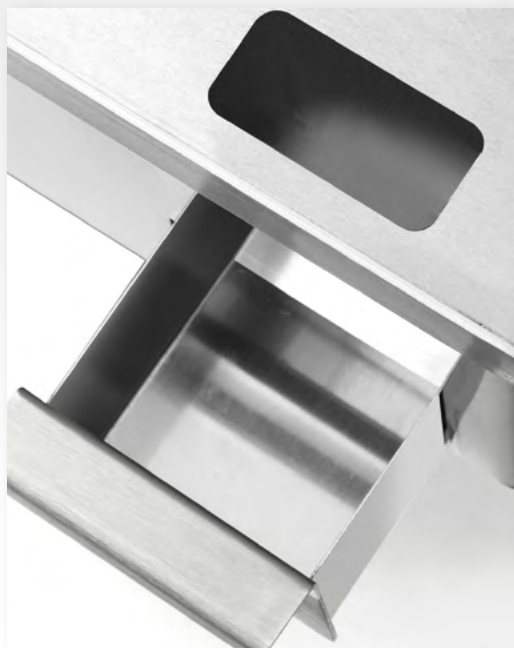

Cajón recolector
Collection box



NC-100N + SW-35



Placa adaptable al alimento
Food-adaptable plate



NS-100N + SW-35

► Grill en acero inoxidable 18/8, con placa calefactora en acero inoxidable 18/8 de 3 mm de espesor y de 1000W de potencia.

GRILL ADAPTABLE A CUALQUIER PLANCHA PROFESIONAL DE MAINHO.

► Grill in 18/8 stainless steel, with heating plate in 18/8 stainless steel 3 mm thick and 1000W power.

GRILL ADAPTABLE TO ANY PROFESSIONAL MAINHO GRIDDLE.



Monofásico 230 V 50/60 Hz
Single-phase 230 V 50/60 Hz

Situación conexión
Connection situation
● Eléctrico

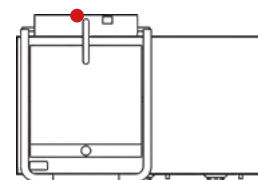

Modelos	Medidas exteriores	Superficie útil	Kg neto	Kg bruto	kW	m ³	€
SW-35	41,5x53x17h	35x35	12,5	-	1	-	919

Equipamiento & accesorios

Equipment & accessories



EST-2
Estante
Shelf

NC-80 + TB-80 + EST-2 + BS-1
NC-80 + TB-80 + EST-2 + SB-1



Funda (COB)
Griddle cover

SB-1
Soporte
botellas
Trolley bottle
support



Tapa basculante cerrada (TB)
Griddle tilting lid

Spatula
Small spatula
Hard chrome scraper
Slotted scraper
Degreaser 12 u.
Degreaser 6 u.
Degreaser 1 u.
Griddle cover NC - NS
Griddle cover NC - NS
Griddle cover NC - NS
Griddle cover NC - NS
Griddle tilting lid NC - NS
Griddle tilting lid NC - NS
Griddle tilting lid NC - NS
Trolley shelf CNE
Trolley bottle support CNE-80
Griddle trolley (NC - NE - NS)
Griddle trolley (NC - NE - NS)
Griddle trolley (NC - NE - NS)

Ref.	Descripción	Medidas Exteriores	Kg Neto	Medidas Embalaje	Kg Bruto	m ³	€
Z-E-1	Espátula	-	100g	31x12x4h	170g	-	14
Z-E-2	Espátula pequeña	-	65g	31x12x4h	135g	-	13
Z-C-1	Rasqueta de cromo duro	-	240g	31x12x4h	310g	-	47
Z-C-2	Rasqueta ranurada	-	195g	31x12x4h	265g	-	18
ZK-PAC-12	Desengrasante 12 uds	-	13,3	37x29x27h	14,5	0,02	250
ZK-PAC-6	Desengrasante 6 uds	-	6,6	28x19,5x27h	7,5	0,01	132
ZK-PAC-1	Desengrasante 1 ud	-	1,1	7x9x24h	-	-	34
COB-45	Funda de planchas NC - NS	47x47x25h	205g	-	-	-	36
COB-60	Funda de planchas NC - NS	62x47x25h	250g	-	-	-	49
COB-80	Funda de planchas NC - NS	82x47x25h	305g	-	-	-	55
COB-100	Funda de planchas NC - NS	102x47x25h	350g	-	-	-	70
TB-40	Tapa basculante planchas (NC - NS)	41x46x15h	3	47x42x17h	4	0,03	205
TB-60	Tapa basculante planchas (NC - NS)	61x46x15h	5	64x49x17h	6	0,05	228
TB-80	Tapa basculante planchas (NC - NS)	81x46x15h	5,5	84x49x17h	7	0,07	246
EST-2	Estante carro CNE	30x43x11h	2	32x44x12h	2,5	0,02	122
SB-1	Soporte botellas carro CNE-80	31,5x30x96h	1,5	32x31x15h	2	0,01	139
C-NE-60	Carro planchas (NC - NE - NS)	60x43x79h	17,5	68x65x17h	19,5	0,09	910
C-NE-80	Carro planchas (NC - NE - NS)	80x43x79h	24	88x65x17h	26	0,09	922
C-NE-100	Carro planchas (NC - NE - NS)	100x43x79h	30,5	108x65x17h	32,5	0,09	1.103



Serie ECO-CD

Cromo duro - Hard chrome

NUEVO
NEW



Cajón recolector
Collection box



ECOEM-60CD UNI



ECO-90CD UNI

- ▶ Placa de **cromo duro** de más de 60 micras y 12 mm de espesor. ▶ Disponen de cajón recolector en el frontal.
- 💧 Encendido por piezoeléctrico. ▶ Válvulas termostáticas.
- ⚡ Resistencias blindadas de acero inoxidable. ▶ Termostatos con conmutador de encendido.

- ▶ **Hard chrome** griddle of more than 60 microns and 12 mm thick. ▶ They have a collector drawer on the front.
- 💧 Piezoelectric ignition. ▶ Thermostatic valves.
- ⚡ Stainless steel shielded heating elements. ▶ Thermostats with ignition switch.

Modelos	Medidas exteriores	Superficie útil	Kg neto	kW	Kcal/h	Medidas embalaje	Kg bruto	m ³	€
ECO-45CD UNI	46x43,5x19h	44x39	22	4,1	3.526	51x53x24h	24	0,07	975
ECO-60CD UNI	61x43,5x19h	59x39	31	8,2	7.052	64x53x24h	33	0,08	1.161
ECO-75CD UNI	76x43,5x19h	74x39	38	8,7	7.482	79,5x53x24h	40	0,10	1.321
ECO-90CD UNI	91x43,5x19h	89x39	45	12,7	10.922	104x53x37h	53	0,20	1.569
ECOEM-45CD UNI	46x43,5x19h	44x39	22	2,6	-	51x53x24h	24	0,07	975
ECOEM-60CD UNI	61x43,5x19h	59x39	31	4	-	64x53x24h	33	0,08	1.194
ECOEM-75CD UNI	76x43,5x19h	74x39	38	4	-	79,5x53x24h	40	0,10	1.309
ECOEM-90CD UNI	91x43,5x19h	89x39	45	6	-	104x53x37h	53	0,20	1.645



Modelos ECOEM:
Monofásico 230 V 50/60 Hz
ECOEM Models:
Single-phase 230 V 50/60 Hz

Situación conexión
Connection situation
● Gas 1/2" ● Eléctrico



NUEVO
NEW

Serie ECO-PV

Pavonadas - Blued



ECO-45PV UNI



ECOEM-75PV UNI



Cajón recolector
Collection box

- ▶ Placa de **acero pavonado** de 6mm. ▶ Disponen de un cajón recolector en el frontal.
- ⬆ Encendido por piezoeléctrico. ▶ Válvulas de gas con termopar de seguridad.
- ⚡ Resistencias blindadas de acero inoxidable. ▶ Termostatos con conmutador de encendido.

- ▶ **Hard chrome** griddle of more than 60 microns and 12 mm thick. ▶ The have a drawer collector on the front.
- ⬆ Piezoelectric ignition. ▶ Gas valves with safety thermocouple.
- ⚡ Stainless steel shielded heating elements. ▶ Thermostats with ignition switch.

Modelos	Medidas exteriores	Superficie útil	Kg neto	kW	Kcal/h	Medidas embalaje	Kg bruto	m ³	€
ECO-45PV UNI	46x43,5x19h	44x39	15	4,1	3.526	51x53x24h	17	0,07	479
ECO-60PV UNI	61x43,5x19h	59x39	21	8,2	7.052	64x53x24h	23	0,08	621
ECO-75PV UNI	76x43,5x19h	74x39	26	8,7	7.482	79,5x53x24h	28	0,10	648
ECO-90PV UNI	91x43,5x19h	89x39	30	12,7	10.922	104x53x24h	33	0,14	791
ECOEM-45PV UNI	46x43,5x19h	44x39	15	2,6	-	51x53x24h	17	0,07	654
ECOEM-60PV UNI	61x43,5x19h	59x39	21	4	-	64x53x24h	23	0,08	731
ECOEM-75PV UNI	76x43,5x19h	74x39	26	4	-	79,5x53x24h	28	0,10	745
ECOEM-90PV UNI	91x43,5x19h	89x39	30	6	-	104x53x24h	33	0,14	979



Modelos ECOEM:
Monofásico 230 V 50/60 Hz
ECOEM Models:
Single-phase 230 V 50/60 Hz

Situación conexión
Connection situation
● Gas 1/2" ● Eléctrico



Serie ECO-Sandwichera

Adaptable a todos los modelos
Adaptable to all models



Detalle sandwichera abierta
Detail of open sandwich maker



ECO-45PV UNI + SW-35



ECO-90CD UNI + SW-35

► Grill en acero inoxidable 18/8, con placa calefactora en acero inoxidable 18/8 de 3 mm de espesor y de 1000W de potencia.

GRILL ADAPTABLE A CUALQUIER PLANCHA SERIE ECO DE MAINHO.

► Grill in 18/8 stainless steel, with heating plate in 18/8 stainless steel 3 mm thick and 1000W power.

GRILL ADAPTABLE TO ANY MAINHO ECO SERIES GRIDDLE.



Monofásico 230 V 50/60 Hz
Single-phase 230 V 50/60 Hz

Situación conexión
Connection situation
● Eléctrico

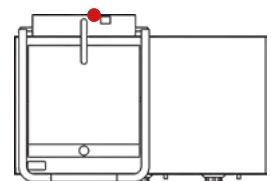

Modelos	Medidas exteriores	Superficie útil	Kg neto	Kg bruto	kW	m ³	€
SW-35	41,5x53x17h	35x35	12,5	-	1	-	919

Equipamiento & accesorios

Equipment & accessories



EST-3
Estante
Trolley shelf

Carro tijera completo /
Complete scissor trolley
ECO-75PV UNI + EST-3



Tapa TEB-75 UNI abierta
Open TEB-75 UNI Lid



Funda puesta
Cover on

Spatula
Small spatula
Hard chrome scraper
Slotted scraper
Degreaser 12 u.
Degreaser 6 u.
Degreaser 1 u.
Griddle cover ECO-45
Griddle cover ECO-60
Griddle cover ECO-75
Griddle cover ECO-90
Griddle tilting lid
Griddle tilting lid
Griddle tilting lid
Griddle tilting lid
Trolley shelf
ECO griddle scissor trolley
ECO griddle scissor trolley
ECO griddle scissor trolley
ECO griddle scissor trolley

Ref.	Descripción	Medidas Exteriores	Kg Neto	Medidas Embalaje	€
Z-E-1	Espátula	-	-	-	14
Z-E-2	Espátula pequeña	-	-	-	13
Z-C-1	Rasqueta de cromo duro	-	-	-	47
Z-C-2	Rasqueta ranurada	-	-	-	18
ZK-PAC-12	Desengrasante 12 uds	-	15,2	33x37x27h	248
ZK-PAC-6	Desengrasante 6 uds	-	7,5	27x28x20h	131
ZK-PAC-1	Desengrasante 1 ud	-	-	-	34
COB-45	Funda de planchas ECO-45	47x47x25h	-	-	36
COB-60	Funda de planchas ECO-60	62x47x25h	-	-	49
COB-80	Funda de planchas ECO-75	82x47x25h	-	-	55
COB-100	Funda de planchas ECO-90	102x47x25h	-	-	70
TEB-45 UNI	Tapa basculante planchas	47x44x96h	3	64x49x17h	165
TEB-60 UNI	Tapa basculante planchas	47x44x96h	3,5	64x49x17h	170
TEB-75 UNI	Tapa basculante planchas	47x44x96h	4	84x49x17h	182
TEB-90 UNI	Tapa basculante planchas	47x44x96h	4,5	94x46x12h	213
EST-3	Estante carro	34,5x36,5x96h	1,5	35x37x10h	78
X-45	Carro tijera para plancha ECO	56x47,5x73h	10	119x51x19h	270
X-60	Carro tijera para plancha ECO	65,5x47,5x73h	10	119x51x19h	281
X-75	Carro tijera para plancha ECO	80x47,5x73h	11	119x51x19h	293
X-90	Carro tijera para plancha ECO	94,5x47,5x73h	12	119x51x19h	307

The background of the image shows a close-up of industrial machinery, likely a conveyor belt or a sorting system, with a prominent purple vertical bar running down the center. The machinery consists of metal rollers and a wooden or cardboard surface. The text is overlaid on this background.

*SNACK
PRODUCTS*

PRODUCTOS

SNACK

Equipamiento económico.
Economic equipment.



NUEVO
NEW

Cocina encimera auxiliar

Gas cooktops



FOC-1



FOC-2



Detalle del quemador
Burner detail

- ▶ Fuegos de 6kW de potencia.
- ▶ Diámetro de la corona: Ø 120mm.
- ▶ Cuerpo del fogón de acero al carbono y corona de latón.
- ▶ Válvulas de gas con termopar de seguridad.
- ▶ Rejillas de acero inoxidable de fácil extracción y limpieza.
- ▶ Sobre monobloc en inoxidable con cantos redondeados.
- ▶ Fácil manejo en la cocción.
- ▶ Patas regulables en altura.

- ▶ Burners with 6 kW.
- ▶ Crown diameter: Ø 120 mm.
- ▶ Carbon steel ring body and brass crown.
- ▶ Gas valves with safety thermocouple.
- ▶ Easy to remove and clean stainless steel racks.
- ▶ Stainless steel monobloc with rounded edges.
- ▶ Easy handling during cooking.
- ▶ Height-adjustable legs.

Modelos	Medidas exteriores	Nº fuegos	Kg neto	kW	Kcal/h	Medidas embalaje	Kg bruto	m ³	€
FOC-1	30x38,5x19h	1	11	6	5.100	35x42x23h	13	0,08	288
FOC-2	60x38,5x19h	2	18	12	10.200	75x42x23h	24	0,15	409

50-55

LOTUS®

PIANI LAVORO

MOD. _____
COD. _____

DESCRIZIONE/DESCRIPTION/BEZEICHNUNG/DESCRIPTION/DESCRIPCIÓN
DIMENSIONI/DIMENSIONS/ABMESSUNGEN/DIMENSIONS/DIMENSIONES

POTENZA/POWER/LEISTUNG/PUISSANCE/POTENCIA
VOLTAGGIO/VOLTAGE/SPANNUNG/VOLTAGE/VOLTAGE

⚡ kW _____
kcal/h _____
V~ _____
Hz _____

PREZZO/PRICE €
PREIS/PRIX/PRECIO €
KG / M³

PL-1
05013000
PIANO LAVORO
EN Worktop • **DE** Arbeitsplatte • **FR** Plan de travail • **ES SOBRE DE TRABAJO**
cm. 30x 50x 29h

370,00
8 / 0,07



PL-2
05016000
cm. 60x 50x 29h

484,00
13 / 0,14

LA
05026000
LAVELLO Vasca cm 34x40x17h
EN Sink unit - Bowl cm 34x40x17h • **DE** Spülbecken - Becken cm 34x40x17h • **FR** Bac-évier - Bac cm 34x40x17h • **ES FREGADERO - CUBA CM 34X40X17H**
cm. 60x 50x 29h

828,00
12 / 0,14

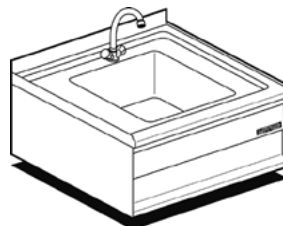

PC-1EM
05033010
PIANO COTTURA elettrico 2 piastre
EN Electric Cooking top nr.2 plates • **DE** Kochplatte elektrische - N. 2 Kochplatten • **FR** Rechaud électriques - N. 2 plaques • **ES SOBRE DE COCCIÓN ELÉCTRICO N. 2 PLANCHAS**
cm. 30x 50x 29h

⚡ 2,5 kW _____
230V~ _____
50/60 Hz _____

738,00
11 / 0,07

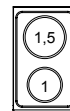

PC-2EM
05036010
PIANO COTTURA elettrico 4 piastre
EN Electric Cooking top nr.4 plates • **DE** Kochplatte elektrische - N. 4 Kochplatten • **FR** Rechaud électriques - N. 4 plaques • **ES SOBRE DE COCCIÓN ELÉCTRICO N. 4 PLANCHAS**
cm. 60x 50x 29h

⚡ 5 kW _____
230V~ _____
50/60 Hz _____

1.218,00
17 / 0,14

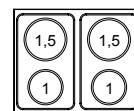
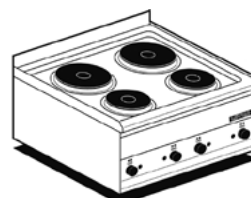

PC-2ET
05036030
cm. 60x 50x 29h

⚡ 5 kW _____
400V~3N _____
230V~3 _____
50/60 Hz _____

1.236,00
17 / 0,14

RI-1EM
05043110
RISCALDANTE INFRAROSSO elettrico
EN Electric Infrared heater • **DE** Infrarot-Strahler elektrische • **FR** Lampe chauffante a infra-rouge électriques • **ES CALENTADOR A INFRARROJOS ELÉCTRICO**
cm. 29x 46x 37h

⚡ 0,32 kW _____
230V~ _____
50/60 Hz _____

492,00
7 / 0,09



BS-1EM
05043010
CONTENITORE CALDO elettrico Vasca GN 1/2 cm.15h con falsofondo forato
EN Fritten Fry dump - Basin GN 1/2 15h with perforated double bottom • **DE** Frittenwanne elektrische - Becken GN 1/2 15h mit gelochtem Bodenrost • **FR** Silo a frites électriques - Cuve GN 1/2 15h avec double-fond perforé • **ES RECIPIENTE CALIENTE ELÉCTRICO - CUBA GN 1/2 15H CONFALSO FONDO AGUJERADO**
cm. 30x 50x 29h

⚡ 0,83 kW _____
230V~ _____
50/60 Hz _____

821,00
10 / 0,07

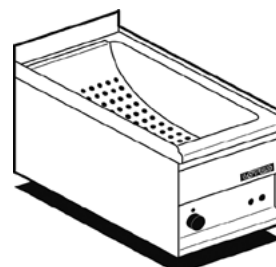

FRY-TOP ELETTRICI

MOD. _____ DESCRIZIONE/DESCRIPTION/BEZEICHNUNG/DESCRIPTION/DESCRIPCIÓN POTENZA/POWER/LEISTUNG/PUISSANCE/POTENCIA ⚡kW ⚡kw PREZZO/PRICE €
 COD. _____ DIMENSIONI/DIMENSIONS/ABMESSUNGEN/DIMENSIONS/DIMENSIONES VOLTAGGIO/VOLTAGE/SPANNUNG/VOLTAGE/VOLTAJE kcal/h ⚡kw V~ Hz PREIS/PRIX/PRECIO €
 KG / M³

FTL-2EM Fry-top elettrico liscio, piastra cm.57x41
 05066011 **EN** Electric Fry-top smooth griddle, plate cm. 57x41 • **DE** Griddleplatte elektrische glatt, platte cm. 57x41 • **FR** Plaque électriques lisse, plaque cm. 57x41 • **ES FRY-TOP ELÉCTRICO LISO, PLANCHA CM. 57X41**
cm. 60x 50x 29h

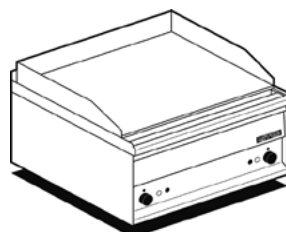

⚡ 5,32 kW **1.474,00**
 230V~ 40 / 0,28
 50/60 Hz

FTL-2ET **cm. 60x 50x 29h**
 05066031

⚡ 6 kW **1.722,00**
 400V~3N 40 / 0,28
 230V~3
 50/60 Hz

FTL-2EMS Fry-top elettrico liscio cromato, piastra cm.57x41
 05066014 **EN** Electric Fry-top smooth chromed griddle, plate cm. 57x41 • **DE** Griddleplatte elektrische glatt hartverchromt, platte cm. 57x41 • **FR** Plaque électriques lisse chromée, plaque cm. 57x41 • **ES FRY-TOP ELÉCTRICO LISO CROMADO, PLANCHA CM. 57X41**
cm. 60x 50x 29h

⚡ 5,32 kW **2.055,00**
 230V~ 40 / 0,28
 50/60 Hz

FTL-2ETS **cm. 60x 50x 29h**
 05066034

⚡ 6 kW **2.323,00**
 400V~3N 40 / 0,28
 230V~3
 50/60 Hz

FTLR-2EM Fry-top elettrico 1/2 liscio + 1/2 rigato, piastra cm.57x41
 05066012 **EN** Electric Fry-top 1/2 smooth + 1/2 grooved griddle, plate cm. 57x41 • **DE** Griddleplatte elektrische 1/2 glatt + 1/2 gerillt, platte cm. 57x41 • **FR** Plaque électriques 1/2 lisse + 1/2 nervurée, plaque cm. 57x41 • **ES FRY-TOP ELÉCTRICO 1/2 LISO + 1/2 ESTRIADO, PLANCHA CM. 57X41**
cm. 60x 50x 29h

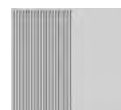

⚡ 5,32 kW **1.691,00**
 230V~ 40 / 0,28
 50/60 Hz

FTLR-2ET **cm. 60x 50x 29h**
 05066032

⚡ 6 kW **1.935,00**
 400V~3N 40 / 0,28
 230V~3
 50/60 Hz

FQ-1EM FRIGGITRICE elettrica - Vasca lt. 8 Cesto cm. 20x27x11h - Produzione patate: 9 Kg/h
 05073010 **EN** Electric fryer - Tank capacity lts. 8 Basket cm. 20x27x11h - Production: 9 Kg/hr • **DE** Friteuse elektrische - Beckeninhalt lt. 8 Korb cm. 20x27x11h - Pommes frites: 9 Kg/pro Stunde • **FR** Friteuse électrique - Cuve lt. 8 Panier cm. 20x27x11h - Production: 9 Kg/h • **ES FREIDORA ELÉCTRICA - CUBA LT.8 CESTA CM. 20X27X11H - PRODUCCIÓN PATATAS: 9 KG/H**
cm. 30x 50x 29h



⚡ 3 kW **1.104,00**
 230V~ 18 / 0,15
 50/60 Hz

FQ-1ET **cm. 30x 50x 29h**
 05073030

⚡ 5,4 kW **1.335,00**
 400V~3N 20 / 0,15
 230V~3
 50/60 Hz

FQ-2EM FRIGGITRICE elettrica - Vasche lt. 8+8 N. 2 cesti cm. 20x27x11h - Produzione patate: 18 Kg/h
 05076010 **EN** Electric fryer - Tank capacity 8+8 lts. N. 2 Baskets cm. 20x27x11h - Production: 18 Kg/hr • **DE** Friteuse elektrische - Beckeninhalt lt. 8+8 - N. 2 Körbe cm. 20x27x11h - Pommes frites: 18 Kg/pro Stunde • **FR** Friteuse électrique - Cuve l. 8+8 N. 2 Paniers cm. 20x27x11h - Production: 18 Kg/h • **ES FREIDORA ELÉCTRICA - CUBA LT. 8 + 8 2 CESTAS CM. 20X27X11H - PRODUCCIÓN PATATAS: 18 KG/H**
cm. 60x 50x 29h

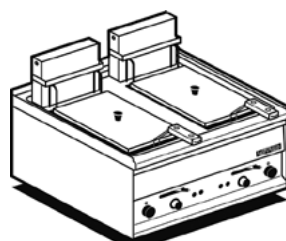

⚡ 6 kW **2.004,00**
 230V~ 33 / 0,28
 50/60 Hz

BAGNOMARIA ELETTRICI

MOD. _____
COD. _____

DESCRIZIONE/DESCRIPTION/BEZEICHNUNG/DESCRIPTION/DESCRIPCIÓN
DIMENSIONI/DIMENSIONS/ABMESSUNGEN/DIMENSIONS/DIMENSIONES

POTENZA/POWER/LEISTUNG/PUISSANCE/POTENCIA
VOLTAGGIO/VOLTAGE/SPANNUNG/VOLTAGE/VOLTAJE

⚡ kW _____
kcal/h _____
V~ _____
Hz _____

PREZZO/PRICE €
PREIS/PRIX/PRECIO €
KG / M³

BM-1EM
05053010

BAGNOMARIA elettrico Vasca per GN 1/2 cm.15h
EN Electric Bain-marie - Bowl for GN 1/2 cm.15h • **DE** Wasserbad elektrische - Becken für GN 1/2 cm.15h • **FR** Bain-marie électriques - Cuve pour GN 1/2 cm.15h • **ES BAÑO DE MARÍA ELÉCTRICO - CUBA PARA GN 1/2 CM.15H**
cm. 30x 50x 29h



⚡ 0,83 kW _____ **812,00**
230V~ _____ 10 / 0,07
50/60 Hz _____

BM-2EM
05056010

BAGNOMARIA elettrico Vasca per GN 1/1 cm.15h
EN Electric Bain-marie - Bowl for GN 1/1 cm.15h • **DE** Wasserbad elektrische - Becken für GN 1/1 cm.15h • **FR** Bain-marie électriques - Cuve pour GN 1/1 cm.15h • **ES BAÑO DE MARÍA ELÉCTRICO - CUBA PARA GN 1/1 CM.15H**
cm. 60x 50x 29h

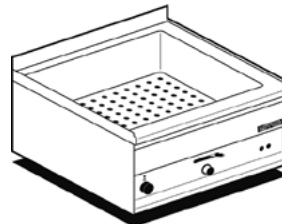

⚡ 1,66 kW _____ **1.078,00**
230V~ _____ 14 / 0,14
50/60 Hz _____

FTL-1EM
05063011

Fry-top elettrico liscio, piastra cm.27x41
EN Electric Fry-top smooth griddle, plate cm. 27x41 • **DE** Griddleplatte elektrische glatt, platte cm. 27x41 • **FR** Plaque électriques lisse, plaque cm. 27x41 • **ES FRY-TOP ELÉCTRICO LISO, PLANCHA CM. 27X41**
cm. 30x 50x 29h



⚡ 2,66 kW _____ **1.027,00**
230V~ _____ 23 / 0,15
50/60 Hz _____

FTL-1ET
05063031

cm. 30x 50x 29h

⚡ 3 kW _____ **1.161,00**
400V~3N _____ 23 / 0,15
230V~3 _____
50/60 Hz _____

FTL-1EMS
05063014

Fry-top elettrico liscio cromato, piastra cm.27x41
EN Electric Fry-top smooth chromed griddle, plate cm. 27x41 • **DE** Griddleplatte elektrische glatt hartverchromt, platte cm. 27x41 • **FR** Plaque électriques lisse chromée, plaque cm. 27x41 • **ES FRY-TOP ELÉCTRICO LISO CROMADO, PLANCHA CM. 27X41**
cm. 30x 50x 29h

⚡ 2,66 kW _____ **1.467,00**
230V~ _____ 23 / 0,15
50/60 Hz _____

FTL-1ETS
05063034

cm. 30x 50x 29h

⚡ 3 kW _____ **1.556,00**
400V~3N _____ 23 / 0,15
230V~3 _____
50/60 Hz _____

FTR-1EM
05063013

Fry-top elettrico rigato, piastra cm.27x41
EN Electric Fry-top grooved griddle, plate cm. 27x41 • **DE** Griddleplatte elektrische gerillt, platte cm. 27x41 • **FR** Plaque électriques nervurée, plaque cm. 27x41 • **ES FRY-TOP ELÉCTRICO ESTRIADO, PLANCHA CM. 27X41**
cm. 30x 50x 29h

⚡ 2,66 kW _____ **1.236,00**
230V~ _____ 23 / 0,15
50/60 Hz _____

FTR-1ET
05063033

cm. 30x 50x 29h

⚡ 3 kW _____ **1.368,00**
400V~3N _____ 23 / 0,15
230V~3 _____
50/60 Hz _____

FRIGGITRICI ELETTRICHE

MOD. _____ DESCRIZIONE/DESCRIPTION/BEZEICHNUNG/DESCRIPTION/DESCRIPCIÓN POTENZA/POWER/LEISTUNG/PUISSANCE/POTENCIA kW kcal/h kw V~ PREZZO/PRICE €
 COD. _____ DIMENSIONI/DIMENSIONS/ABMESSUNGEN/DIMENSIONS/DIMENSIONES VOLTAGGIO/VOLTAGE/SPANNUNG/VOLTAGE/VOLTAJE Hz PREIS/PRIX/PRECIO KG / M³

FQ-2ET cm. 60x 50x 29h
 05076030

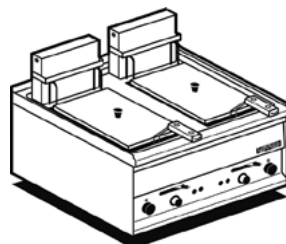

⚡ 10,8 kW **2.442,00**
 400V~3N 35 / 0,28
 230V~3
 50/60 Hz

531014400 Optional: Cesto 1/2
EN Optional: basket 1/2 • **DE** Zubehör: Fritierkorb 1/2 • **FR** En option: panier 1/2 • **ES OPCIONAL: CESTA 1/2**
 cm. 10x 25x 10h

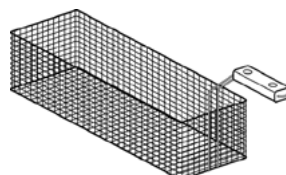

56,00
 0.6 / 0,03

CP-1EM CUOCI-PASTA/VERDURE elettrico - Vasca lt. 10 - N. 4 cestini cm.
 05083010 10x14x13,5h
EN Electric Pastacooker - Tank capacity 10 lts. N. 4 baskets cm. 10x14x13,5h • **DE** Nudelkocher elektrische - Beckeninhalt lt. 10 N. 4 Körbe cm. 10x14x13,5h • **FR** Cuiser a pates/legumes électrique - Cuve l. 10 - N. 4 paniers cm. 10x14x13,5 • **ES CUECE PASTAS/ VERDURAS ELÉCTRICO - CUBA LT.10 - 4 CESTAS CM. 10X14X13,5H**
 cm. 30x 50x 29h



⚡ 2,83 kW **1.128,00**
 230V~ 13 / 0,07
 50/60 Hz

CP-2ET CUOCI-PASTA/VERDURE elettrico - Vasca lt. 20 - N. 8 cestini cm.
 05086030 10x14x13,5h
EN Electric Pastacooker - Tank capacity 20 lts. - N 8 baskets cm. 10x14x13,5h • **DE** Nudelkocher elektrische - Beckeninhalt lt. 20 - N. 8 Körbe cm. 10x14x13,5h • **FR** Cuiser a pates/legumes électrique - Cuve l. 20 - N. 8 paniers cm. 10x14x13,5 • **ES CUECE PASTAS/ VERDURAS ELÉCTRICO - CUBA LT. 20 - 8 CESTAS CM. 10X14X13,5H**
 cm. 60x 50x 29h

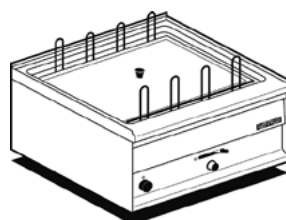

⚡ 6 kW **1.738,00**
 400V~3N 22 / 0,14
 230V~3
 50/60 Hz

531001600 CESTINO 1/4 INOX
EN Stainless steel basket 1/4 • **DE** . Korb 1/4 aus Edelstahl • **FR** Panier inox 1/4 • **ES CESTA 1/4 INOX**
 cm. 10x 14x 13,5h

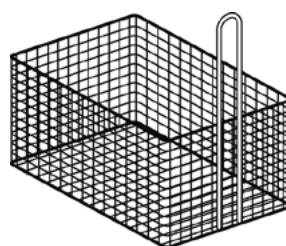

58,00
 / 0,02

531004000 CESTINO 1/2 INOX
EN Stainless steel basket 1/2 • **DE** Korb 1/2 aus Edelstahl • **FR** Panier inox 1/2 • **ES CESTA 1/2 INOX**
 cm. 10x 28x 13,5h

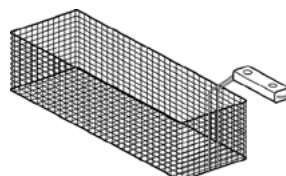

90,00
 / 0,03

531003900 CESTINO 1/1 INOX
EN Stainless steel basket 1/1 • **DE** Korb 1/1 aus Edelstahl • **FR** Panier inox 1/1 • **ES CESTA 1/1 INOX**
 cm. 20x 28x 13,5h

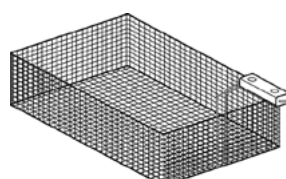

118,00
 / 0,04

MOBILI BASE

MOD. COD.	DESCRIZIONE/DESCRIPTION/BEZEICHNUNG/DESCRIPTION/DESCRIPCIÓN DIMENSIONI/DIMENSIONS/ABMESSUNGEN/DIMENSIONS/DIMENSIONES	POTENZA/POWER/LEISTUNG/PUISSANCE/POTENCIA VOLTAGGIO/VOLTAGE/SPANNUNG/VOLTAGE/VOLTAJE	⚡kW kcal/h	⚡kw V~ Hz	PREZZO/PRICE PREIS/PRIX/PRECIO € KG / M³
S-3 05210300	CAVALLETTO BASE EN Stand • DE Untergestell • FR Piedement simple • ES SOPORTE BASE cm. 30x 40x 60h				229,00 2 / 0,12
S-6 05210600	cm. 60x 40x 60h				252,00 3 / 0,22
M-3 05220300	MOBILE BASE EN Stand • DE Offener Unterbau • FR Placard ouvert • ES MUEBLE BASE cm. 30x 40x 60h				424,00 9 / 0,09
M-6 05220600	cm. 60x 40x 60h				462,00 12 / 0,16
M-9 05220900	cm. 90x 40x 60h				540,00 16 / 0,23
M-12 05221200	cm. 120x 40x 60h				622,00 19 / 0,30
R-3 05240300	RIPIANO EN Shelf • DE Abstellbrett • FR Etagère • ES ESTANTE cm. 26x 39,5x 3h				114,00 1 / 0,01
R-6 05240600	cm. 56x 39,5x 3h				143,00 2 / 0,01
P-61 06256000	PORTA EN Door • DE Flügeltür • FR Porte • ES PUERTA cm. 29,5x 2,5x 47h				197,00 2.5 / 0,01
CG-5 05264800	COPRIGIUNTO EN Joint cover • DE Klemmsteg • FR Couvre-joint • ES CUBRE JUNTA cm. 48,5x 0,7x 1,5h				32,00 0.1 / 1,00
TG-1 05270300	TAGLIERE EN Chopping board • DE Schneidebrett • FR Plan a découpe • ES PICADOR cm. 29x 48,5x 2,5h				133,00 4 / 0,01
TG-2 05270600	cm. 59x 48,5x 2,5h				234,00 8 / 0,01

IPERLOTUS 55



Líneas 50-55

CUCINE A GAS

MOD. _____
COD. _____

DESCRIZIONE/DESCRIPTION/BEZEICHNUNG/DESCRIPTION/DESCRIPCIÓN
DIMENSIONI/DIMENSIONS/ABMESSUNGEN/DIMENSIONS/DIMENSIONES

POTENZA/POWER/LEISTUNG/PUISSANCE/POTENCIA
VOLTAGGIO/VOLTAGE/SPANNUNG/VOLTAGE/VOLTAJE

kw kcal/h
V~ Hz

PREZZO/PRICE €
PREIS/PRIX/PRECIO €
KG / M³

CF2-58G
15120850

CUCINETTA 2 FUOCHI - FORNO GAS STATICO con grill cm. 67x38x34h, temp: 50÷250°C, con 1 griglia cm.65x36
EN Gas range - N. 2 burners Gas static oven with grill cm. 67x38x34h, temp: 50÷250°C, with 1 grid cm.65x36 • **DE** Gasherd - N. 2 Kochstellen Statischer Gas-Backofen mit Grill cm. 67x38x34h, temp: 50÷250°C, mit 1 Rost cm.65x36 • **FR** Cuisinière à gaz - N. 2 feux vifs Four gaz statique avec grill cm. 67x38x34h, temp: 50÷250°C, avec 1 grille cm.65x36 • **ES COCINA A GAS - N. 2 QUEMADORES HORNO GAS ESTÁTICO CON ASADOR CM. 67X38X34H, TEMP: 50÷250°C, CON 1 PARRILLA CM.65X36 cm. 80x 55x 90h**



21 kW 3.531,00
18.060 kcal/h 122 / 0,61

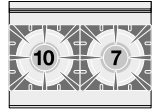

CF2-58GE
15130860

CUCINETTA 2 FUOCHI - FORNO ELETTRICO STATICO con grill cm. 67x38x34h, temp: 50÷250°C, con 1 griglia cm.65x36
EN Gas range - N. 2 burners Electric static oven with grill cm. 67x38x34h, temp: 50÷250°C, with 1 grid cm.65x36 • **DE** Gasherd - N. 2 Kochstellen - Statischer Elektro-Backofen mit Grill cm. 67x38x34h, temp: 50÷250°C, mit 1 Rost cm.65x36 • **FR** Cuisinière à gaz - N. 2 feux vifs - Four électrique statique avec grill cm. 67x38x34h, temp: 50÷250°C, avec 1 grille cm.65x36 • **ES COCINA A GAS - N. 2 QUEMADORES - HORNO ELÉCTRICO ESTÁTICO CON ASADOR CM. 67X38X34H, TEMP: 50÷250°C, CON 1 PARRILLA CM.65X36 cm. 80x 55x 90h**



17 kW 3.531,00
14.620 kcal/h 120 / 0,61

3,05 kW
230V~
50/60 Hz

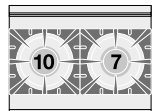

CF3-512GV
15121251

CUCINETTA 3 FUOCHI - FORNO GAS STATICO con grill cm. 67x38x34h, temp: 50÷250°C, con 1 griglia cm.65x36. Vano neutro con porta
EN Gas range - N. 3 burners - Gas static oven with grill cm. 67x38x34h, temp: 50÷250°C, with 1 grid cm.65x36 - Neutral cabinet with door • **DE** Gasherd - N. 3 Kochstellen - Statischer Gas-Backofen mit Grill cm. 67x38x34h, temp: 50÷250°C, mit 1 Rost cm.65x36 - Neutrales Schrankelement mit Tür • **FR** Cuisinière gaz - N. 3 feux vifs - Four gaz statique avec grill cm. 67x38x34h, temp: 50÷250°C, avec 1 grille cm.65x36 - Élément neutre avec porte • **ES COCINA A GAS - N. 3 QUEMADORES - HORNO GAS ESTÁTICO CON ASADOR CM. 67X38X34H, TEMP: 50÷250°C, CON 1 PARRILLA CM.65X36 - ARMARIO NEUTRO CON PUERTA cm. 120x 55x 90h**



31 kW 4.400,00
26.660 kcal/h 150 / 0,91

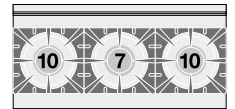

CF3-512GEV
15131261

CUCINETTA 3 FUOCHI - FORNO ELETTRICO STATICO con grill cm. 67x38x34h, temp: 50÷250°C, con 1 griglia cm.65x36. Vano neutro con porta
EN Gas range - N. 3 burners - Electric static oven with grill cm. 67x38x34h, temp: 50÷250°C, with 1 grid cm.65x36 - Neutral cabinet with door • **DE** Gasherd - N. 3 Kochstellen - Statischer Elektro-Backofen mit Grill cm. 67x38x34h, temp: 50÷250°C, mit 1 Rost cm.65x36 - Neutrales Schrankelement mit Tür • **FR** Cuisinière gaz - N. 3 feux vifs - Four électrique statique avec grill cm. 67x38x34h, temp: 50÷250°C, avec 1 grille cm.65x36 - Élément neutre avec porte • **ES COCINA A GAS - N. 3 QUEMADORES - HORNO ELÉCTRICO ESTÁTICO CON ASADOR CM. 67X38X34H, TEMP: 50÷250°C, CON 1 PARRILLA CM.65X36 - ARMARIO NEUTRO CON PUERTA cm. 120x 55x 90h**



27 kW 4.400,00
23.220 kcal/h 148 / 0,91

3,05 kW
230V~
50/60 Hz

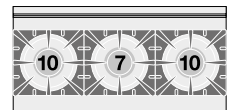

KIT-WOK
09580040

KIT WOK - fiamma verticale - solo su bruciatore da 10 kW e griglie in ghisa
EN KIT WOK - vertical flame - only for 10 kW burner and cast iron grills • **DE** KIT WOK - vertikaler Flamme - nur 10 kW-Brenner und Roste aus Gusseisen • **FR** KIT WOK - verticale de la flamme - seulement 10 kW brûleur et grilles en fonte • **ES KIT WOK - LLAMA VERTICAL - SÓLO 10 KW QUEMADOR Y PARRILAS DE HIERRO COLADO cm. Ø 26x 16h**



456,00
5 / 0,02

60

لوتس®

BAGNOMARIA ELETTRICI - TOP

MOD. _____
COD. _____

DESCRIZIONE/DESCRIPTION/BEZEICHNUNG/DESCRIPTION/DESCRIPCIÓN
DIMENSIONI/DIMENSIONS/ABMESSUNGEN/DIMENSIONS/DIMENSIONES

POTENZA/POWER/LEISTUNG/PUISSANCE/POTENCIA
VOLTAGGIO/VOLTAGE/SPANNUNG/VOLTAGE/VOLTAGE

⚡ kW
kcal/h
⚡ kw
V~
Hz

PREZZO/PRICE €
PREIS/PRIX/PRECIO €
KG / M³

BMT-63EM Bagnomaria elettrico monofase Vasca per GN 1/2 + GN 1/4 h=15
16050310 **EN** Bain marie singlephase Bowl for GN 1/2 + GN 1/4 h=15 • **DE** Wasserbäder einphasig Becken GN 1/2 + GN 1/4 h=15 • **FR** Bain marie monophasé Cuve GN 1/2 + GN 1/4 h=15 • **ES BAÑO DE MARÍA MONOFÁSICO CUBA PARA GN 1/2 + GN 1/4 H=15**

cm. 30x 60x 28h



⚡ 1,55 kW
230V~
50/60 Hz **1.037,00**
17 / 0,15

BMT-64EM Bagnomaria elettrico monofase Vasca per GN 1/2 + GN 1/3 h=15
16050410 **EN** Bain marie singlephase Bowl for GN 1/2 + GN 1/3 h=15 • **DE** Wasserbäder einphasig Becken GN 1/2 + GN 1/3 h=15 • **FR** Bain marie monophasé Cuve GN 1/2 + GN 1/3 h=15 • **ES BAÑO DE MARÍA MONOFÁSICO CUBA PARA GN 1/2 + GN 1/3 H=15**

cm. 40x 60x 28h

⚡ 1,65 kW
230V~
50/60 Hz **1.209,00**
21 / 0,19

BMT-66EM Bagnomaria elettrico monofase Vasca per GN 1/1 + 2 GN 1/4 h=15
16050610 **EN** Bain marie singlephase Bowl for GN 1/1 + 2 GN 1/4 h=15 • **DE** Wasserbäder einphasig Becken GN 1/1 + 2 GN 1/4 h=15 • **FR** Bain marie monophasé Cuve GN 1/1 + 2 GN 1/4 h=15 • **ES BAÑO DE MARÍA MONOFÁSICO CUBA PARA GN 1/1 + 2 GN 1/4 H=15**

cm. 60x 60x 28h

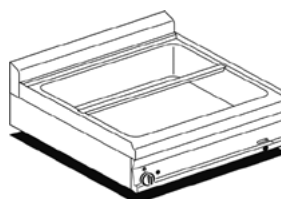

⚡ 3,1 kW
230V~
50/60 Hz **1.338,00**
23 / 0,28

BMT-64G Bagnomaria a gas Vasca per GN 1/2 + GN 1/3 h=15
16220450 **EN** Gas bain-marie Bowl for GN 1/2 + GN 1/3 h=15 • **DE** Gas Wasserbad Becken GN 1/2 + GN 1/3 h=15 • **FR** Bain-marie gaz Cuve pour GN 1/2 + GN 1/3 h=15 • **ES BAÑO DE MARÍA GAS CUBA PARA GN 1/2 + GN 1/3 H=15**

cm. 40x 60x 28h

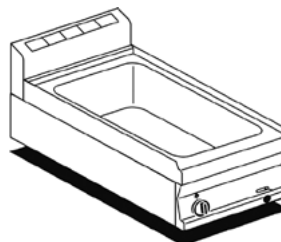

⚡ 2,5 kW
2.150 kcal/h **1.524,00**
26 / 0,19

BMT-66G Bagnomaria a gas Vasca per GN 1/1 + 2 GN 1/4 h=15
16220650 **EN** Gas bain-marie Bowl for GN 1/1 + 2 GN 1/4 h=15 • **DE** Gas Wasserbad Becken GN 1/1 + 2 GN 1/4 h=15 • **FR** Bain-marie gaz Cuve pour GN 1/1 + 2 GN 1/4 h=15 • **ES BAÑO DE MARÍA GAS CUBA PARA GN 1/1 + 2 GN 1/4 H=15**

cm. 60x 60x 28h



⚡ 4,5 kW
3.870 kcal/h **1.845,00**
28 / 0,28

BST-64EM Contenitore caldo monofase Vasca GN 2/3 h15 con falso fondo forato
16040410 **EN** Fry dump singlephase Bowl GN 2/3 h15 with perforated bottom • **DE** Frittenwanne einphasig Becke GN 2/3 h15 mit gelochtem Bodenrost • **FR** Silo à frites monophasé Cuve GN 2/3 h15 avec double-fond perforé • **ES RECIPIENTE CALIENTE MONOFÁSICO CUBA GN 2/3 H15 CON FALSO FONDO AGUJERADO**

cm. 40x 60x 28h



⚡ 1,47 kW
230V~
50/60 Hz **1.406,00**
22 / 0,19

BRF-64ET BRASIERA FISSA MULTIFUNZIONALE ELETTRICA - lt.12 Vasca cm.
06070433 30x42x10h **EN** Electric multi-function fixed braising pan - lt.12 Bowl cm. 30x42x10h • **DE** Elektrische Multifunktionsbratpfanne Fest - lt.12 Becken cm. 30x42x10h • **FR** Sauteuse fixe multifonction électrique - lt.12 Cuve cm. 30x42x10h • **ES SARTEN FIJA MULTIFUNCIÓN ELÉCTRICA CUBA - LT.12 CM. 30X42X10H**

cm. 40x 60x 90h



⚡ 3,3 kW
400V~3N
230V~3
50/60 Hz **3.780,00**
75 / 0,37

BRASIERE FISSE MULTIFUNZIONE A GAS

MOD. _____
COD. _____

DESCRIZIONE/DESCRIPTION/BEZEICHNUNG/DESCRIPTION/DESCRIPCIÓN
DIMENSIONI/DIMENSIONS/ABMESSUNGEN/DIMENSIONS/DIMENSIONES

POTENZA/POWER/LEISTUNG/PUISSANCE/POTENCIA
VOLTAGGIO/VOLTAGE/SPANNUNG/VOLTAGE/VOLTAGE

6 kW
kcal/h

kw
V~
Hz

PREZZO/PRICE €
PREIS/PRIX/PRECIO €
KG / M³

BRF-64G
06240453

BRASIERA FISSA MULTIFUNZIONALE GAS- Lt.12 Vasca 30x42x10h
EN Gas multi-function fixed braising pan - Lt.12 Bowl 30x42x10h • **DE** Gas-Multifunktionsbratpfanne Fest - Lt.12 Becken 30x42x10h • **FR** Sauteuse fixe multifonction à gaz - Lt.12 Cuve 30x42x10h • **ES SARTEN FIJA MULTIFUNCIÓN A GAS CUBA - LT.12 30X42X10H**
cm. 40x 60x 90h



6 kW
5.160 kcal/h

3.845,00
75 / 0,37

BRT-66ET
16070630

Brasiera trifase - Lt. 20 Vasca cm. 50,5x41x10h
EN Bratt-pan threephase - Tank capacity 20 lts. - Pan cm. 50,5x41x10 h • **DE** Bratpfanne dreiphasig - Lt. 20 - Becken cm. 50,5x41x10 h • **FR** Sauteuse triphase - Lt. 20 - Bac cm. 50,5x41x10h • **ES SARTÉN TRIFÁSICA - 20 LT. - CUBA CM. 50,5X41X10H**
cm. 60x 60x 28h



6 kW
400V~3N
230V~3
50/60 Hz

1.957,00
45 / 0,28

BRT-66G
16240650

BRASIERA GAS - Lt. 20 Vasca cm. 50,5x41x10h
EN Gas bratt-pan - Capacity 20 litres - Pan cm. 50,5x41x10 h • **DE** Gas Bratpfanne - Lt. 20 - Becken cm. 50,5x41x10 h • **FR** Sauteuse gaz - Lt. 20 - Bac cm. 50,5x41x10h • **ES SARTÉN GAS - 20 L. - CUBA CM. 50,5X41X10H**
cm. 60x 60x 28h



6,9 kW
5.930 kcal/h

2.493,00
46 / 0,28

CF4-68G
06680850

cucina a gas 4 fuochi Forno a gas statico con grill cm. 64x39x35h, temp: 125÷275°C, con 1 griglia cm.53x32,5 GN1/1 - Porta vetro
EN Gas range - N. 4 burners - Gas static oven with grill cm. 64x39x35h, temp: 125÷275°C, with 1 grid cm.53x32,5 GN1/1 - glass door • **DE** Gasherd - N. 4 Kochstellen - Gas Statischer Backofen mit grill cm. 64x39x35h, temp: 125÷275°C, mit 1 Rost cm.53x32,5 GN1/1 - Glastür • **FR** Cuisinière gaz - N. 4 feux vifs - Four gaz statique avec grill cm. 64x39x35h, temp: 125÷275°C, avec 1 grille cm.53x32,5 GN1/1 - Porte vitrée • **ES COCINA GAS - N. 4 QUEMADORES - HORNO GAS ESTÁTICO CON ASADOR CM. 64X39X35H, TEMP: 125÷275 °C, CON 1 PARILLA CM.53X32,5 GN1/1 - PUERTA VIDRIO**
cm. 80x 60x 90h



22 kW
18.920 kcal/h

3.693,00
97 / 0,62

0,015 kW
230V~
50/60 Hz

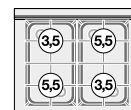

CF4-68G
06680851

cucina a gas 4 fuochi Forno a gas statico con grill cm. 64x39x35h, temp: 125÷275°C, con 1 griglia cm.53x32,5 GN1/1 - Porta cieca inox
EN Gas range - N. 4 burners - Gas static oven with grill cm. 64x39x35h, temp: 125÷275°C, with 1 grid cm.53x32,5 GN1/1 - Stainless steel door • **DE** Gasherd - N. 4 Kochstellen - Gas Statischer Backofen mit grill cm. 64x39x35h, temp: 125÷275°C, mit 1 Rost cm.53x32,5 GN1/1 - Edelstahltür/Porte acier inoxydable • **FR** Cuisinière gaz - N. 4 feux vifs - Four gaz statique avec grill cm. 64x39x35h, temp: 125÷275°C, avec 1 grille cm.53x32,5 GN1/1 - Porte acier inoxydable • **ES COCINA GAS - N. 4 QUEMADORES - HORNO GAS ESTÁTICO CON ASADOR CM. 64X39X35H, TEMP: 125÷275 °C, CON 1 PARILLA CM.53X32,5 GN1/1 - PUERTA CIEGA INOX**
cm. 80x 60x 90h



22 kW
18.920 kcal/h

3.693,00
97 / 0,62

0,015 kW
230V~
50/60 Hz

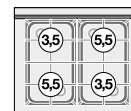

CF6-610G
06681050

cucina a gas 6 fuochi Forno a gas statico con grill cm. 64x39x35h, temp: 125÷275°C, con 1 griglia cm.53x32,5 GN1/1 - Porta vetro
EN Gas range - N. 6 burners - Gas static oven with grill cm. 64x39x35h, temp: 125÷275°C, with 1 grid cm.53x32,5 GN1/1 - glass door • **DE** Gasherd - N. 6 Kochstellen - Gas statischer Backofen mit grill cm. 64x39x35h, temp: 125÷275°C, mit 1 Rost cm.53x32,5 GN1/1 - Glastür • **FR** Cuisinière gaz - N. 6 feux vifs - Four gaz statique avec grill cm. 64x39x35h, temp: 125÷275°C, avec 1 grille cm.53x32,5 GN1/1 - Porte vitrée • **ES COCINA GAS - N. 6 QUEMADORES - HORNO GAS ESTÁTICO CON ASADOR CM. 64X39X35H, TEMP: 125÷275 °C, CON 1 PARILLA CM.53X32,5 GN1/1 - PUERTA VIDRIO**
cm. 100x 60x 90h



31 kW
26.660 kcal/h

3.957,00
106 / 0,77

0,015 kW
230V~
50/60 Hz

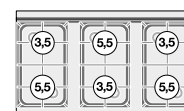

CUCINE A GAS

MOD. _____
COD. _____

DESCRIZIONE/DESCRIPTION/BEZEICHNUNG/DESCRIPTION/DESCRIPCIÓN
DIMENSIONI/DIMENSIONS/ABMESSUNGEN/DIMENSIONS/DIMENSIONES

POTENZA/POWER/LEISTUNG/PUISSANCE/POTENCIA
VOLTAGGIO/VOLTAGE/SPANNUNG/VOLTAGE/VOLTAJE

⚡ kW kcal/h
⚡ 230V~
50/60 Hz

PREZZO/PRICE €
PREIS/PRIX/PRECIO
KG / M³

CF6-610G
06681051

cucina a gas 6 fuochi Forno a gas statico con grill cm. 64x39x35h, temp: 125÷275°C, con 1 griglia cm.53x32,5 GN1/1 - Porta cieca inox
EN Gas range - N. 6 burners - Gas static oven with grill cm. 64x39x35h, temp: 125÷275°C, with 1 grid cm.53x32,5 GN1/1 - Stainless steel door
• **DE** Gasherd - N. 6 Kochstellen - Gas statischer Backofen mit grill cm. 64x39x35h, temp: 125÷275°C, mit 1 Rost cm.53x32,5 GN1/1 - Edelstahltür/Porte acier inoxydable • **FR** Cuisinière gaz - N. 6 feux vifs - Four gaz statique avec grill cm. 64x39x35h, temp: 125÷275°C, avec 1 grille cm.53x32,5 GN1/1 - Porte acier inoxydable • **ES** **COCINA GAS - N. 6 QUEMADORES - HORNO GAS ESTÁTICO CON ASADOR CM. 64X39X35H, TEMP: 125÷275 °C, CON 1 PARILLA CM.53X32,5 GN1/1 - PUERTA CIEGA INOX cm. 100x 60x 90h**



⚡ 31 kW 3.957,00
26.660 kcal/h 106 / 0,77

⚡ 0,015 kW
230V~
50/60 Hz

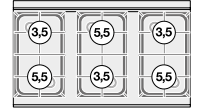

CF4-68GEM
06690860

CUCINA MISTA 4 FUOCHI CON Forno elettrico statico con grill cm. 64x42x35h, temp: 50÷250°C, con 1 griglia cm.53x32,5 GN1/1 - Porta vetro
EN Combined range static oven - N. 4 burners Static oven with grill cm. 64x42x35h, temp: 50÷250°C, with 1 grid cm.53x32,5 GN1/1 - Glass door • **DE** Gemischtherd statischer Ofen - N. 4 Kochstellen Statischer Ofen mit Grill cm. 64x42x35h, temp: 50÷250°C, mit 1 Rost cm.53x32,5 GN1/1 - Glastür • **FR** Cuisinière mixte gaz four statique - N. 4 feux vifs Four statique avec grill cm. 64x42x35h, temp: 50÷250°C, avec 1 grille cm.53x32,5 GN1/1 - Porte vitrée • **ES** **COCINA MIXTA HORNO ESTÁTICO - N. 4 QUEMADORES HORNO ESTÁTICO CON ASADOR CM. 64X42X35H, TEMP: 50÷250 °C, CON 1 PARILLA CM.53X32,5 GN1/1 - PUERTA VIDRIO cm. 80x 60x 90h**



⚡ 18 kW 3.299,00
15.480 kcal/h 97 / 0,62

⚡ 2,62 kW
230V~
50/60 Hz

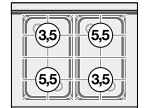

CF4-68GEM
06690861

CUCINA MISTA 4 FUOCHI CON Forno elettrico statico con grill cm. 64x42x35h, temp: 50÷250°C, con 1 griglia cm.53x32,5 GN1/1 - Porta cieca inox
EN Combined range static oven - N. 4 burners Static oven with grill cm. 64x42x35h, temp: 50÷250°C, with 1 grid cm.53x32,5 GN1/1 - Stainless steel door • **DE** Gemischtherd statischer Ofen - N. 4 Kochstellen Statischer Ofen mit Grill cm. 64x42x35h, temp: 50÷250°C, mit 1 Rost cm.53x32,5 GN1/1 - Edelstahltür • **FR** Cuisinière mixte gaz four statique - N. 4 feux vifs Four statique avec grill cm. 64x42x35h, temp: 50÷250°C, avec 1 grille cm.53x32,5 GN1/1 - Porte acier inoxydable • **ES** **COCINA MIXTA HORNO ESTÁTICO - N. 4 QUEMADORES HORNO ESTÁTICO CON ASADOR CM. 64X42X35H, TEMP: 50÷250 °C, CON 1 PARILLA CM.53X32,5 GN1/1 - PUERTA CIEGA INOX cm. 80x 60x 90h**



⚡ 18 kW 3.299,00
15.480 kcal/h 97 / 0,62

⚡ 2,62 kW
230V~
50/60 Hz

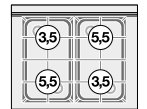

CF6-610GEM
06691060

CUCINA MISTA 6 FUOCHI CON Forno elettrico statico con grill cm. 64x42x35h, temp: 50÷250°C, con 1 griglia cm.53x32,5 GN1/1 - Porta vetro
EN Combined range static oven - N. 6 burners Static oven with grill cm. 64x42x35h, temp: 50÷250°C, with 1 grid cm.53x32,5 GN1/1 - Glass door • **DE** Gemischtherd statischer Ofen - N. 6 Kochstellen Statischer Ofen mit Grill cm. 64x42x35h, temp: 50÷250°C, mit 1 Rost cm.53x32,5 GN1/1 - Glastür • **FR** Cuisinière mixte gaz four statique - N. 6 feux vifs Four statique avec grill cm. 64x42x35h, temp: 50÷250°C, avec 1 grille cm.53x32,5 GN1/1 - Porte vitrée • **ES** **COCINA MIXTA HORNO ESTÁTICO - N. 6 QUEMADORES HORNO ESTÁTICO CON ASADOR CM. 64X42X35H, TEMP: 50÷250 °C, CON 1 PARILLA CM.53X32,5 GN1/1 - PUERTA VIDRIO cm. 100x 60x 90h**



⚡ 27 kW 3.877,00
23.193 kcal/h 106 / 0,77

⚡ 2,62 kW
230V~
50/60 Hz

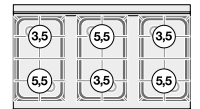

CF6-610GEM
06691061

CUCINA MISTA 6 FUOCHI CON Forno elettrico statico con grill cm. 64x42x35h, temp: 50÷250°C, con 1 griglia cm.53x32,5 GN1/1 - Porta cieca inox
EN Combined range static oven - N. 6 burners Static oven with grill cm. 64x42x35h, temp: 50÷250°C, with 1 grid cm.53x32,5 GN1/1 - Stainless steel door • **DE** Gemischtherd statischer Ofen - N. 6 Kochstellen Statischer Ofen mit Grill cm. 64x42x35h, temp: 50÷250°C, mit 1 Rost cm.53x32,5 GN1/1 - Edelstahltür • **FR** Cuisinière mixte gaz four statique - N. 6 feux vifs Four statique avec grill cm. 64x42x35h, temp: 50÷250°C, avec 1 grille cm.53x32,5 GN1/1 - Porte acier inoxydable • **ES** **COCINA MIXTA HORNO ESTÁTICO - N. 6 QUEMADORES HORNO ESTÁTICO CON ASADOR CM. 64X42X35H, TEMP: 50÷250 °C, CON 1 PARILLA CM.53X32,5 GN1/1 - PUERTA CIEGA INOX**



⚡ 27 kW 3.877,00
23.193 kcal/h 106 / 0,77

⚡ 2,62 kW
230V~
50/60 Hz

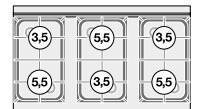

CUCINE ELETTRICHE

MOD. _____
COD. _____

DESCRIZIONE/DESCRIPTION/BEZEICHNUNG/DESCRIPTION/DESCRIPCIÓN
DIMENSIONI/DIMENSIONS/ABMESSUNGEN/DIMENSIONS/DIMENSIONES

POTENZA/POWER/LEISTUNG/PUISSANCE/POTENCIA
VOLTAGGIO/VOLTAGE/SPANNUNG/VOLTAGE/VOLTAGE

⚡ kW
kcal/h

⚡ kW
V~
Hz

PREZZO/PRICE €
PREIS/PRIX/PRECIO €
KG / M³

CFM4-66ET CUCINA ELETTRICA TRIFASE CON 4 PIASTRE Forno elettrico multifunzione camera cm. 46x37x35h, temp: 50÷250°C, con 1 griglia cm.41x32,5 - Porta vetro
06660632

EN Range threephase - N. 4 plates Multifunction electric oven Chamber cm. 46x37x35h, temp: 50÷250°C, with 1 grid cm.41x32,5 - Glass door • **DE** Elektroherd dreiphasig - N. 4 Kochplatten Multifunktions-Elektroofen - cm. 46x37x35h, temp: 50÷250°C, mit 1 Rost cm.41x32,5 - Glastür • **FR** Cuisinière triphase - N. 4 plaques Four électrique à fonctions multiples - cm. 46x37x35h, temp: 50÷250°C, avec 1 grille cm.41x32,5 - Porte vitrée • **ES COCINA TRIFÁSICA - N. 4 PLANCHAS HORNO ELÉCTRICO MULTIFUNCIONAL - CÁMARA CM. 46X37X35H, TEMP: 50÷250 °C, CON 1 PARILLA CM.41X32,5 - PUERTA VIDRIO cm. 60x 60x 90h**



⚡ 9,05 kW
400V~3N
230V~3
230V~
50/60 Hz

3.245,00
70 / 0,47

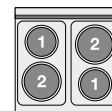

CFM4-66ET CUCINA ELETTRICA TRIFASE CON 4 PIASTRE Forno elettrico multifunzione camera cm. 46x37x35h, temp: 50÷250°C, con 1 griglia cm.41x32,5 - Porta cieca inox
06660633

EN Range threephase - N. 4 plates Multifunction electric oven Chamber cm. 46x37x35h, temp: 50÷250°C, with 1 grid cm.41x32,5 - Stainless steel door • **DE** Elektroherd dreiphasig - N. 4 Kochplatten Multifunktions-Elektroofen - cm. 46x37x35h, temp: 50÷250°C, mit 1 Rost cm.41x32,5 - Edelstahltür • **FR** Cuisinière triphase - N. 4 plaques Four électrique à fonctions multiples - cm. 46x37x35h, temp: 50÷250°C, avec 1 grille cm.41x32,5 - Porte acier inoxydable • **ES COCINA TRIFÁSICA - N. 4 PLANCHAS HORNO ELÉCTRICO MULTIFUNCIONAL - CÁMARA CM. 46X37X35H, TEMP: 50÷250 °C, CON 1 PARILLA CM.41X32,5 - PUERTA CIEGA INOX cm. 60x 60x 90h**



⚡ 9,05 kW
400V~3N
230V~3
230V~
50/60 Hz

3.245,00
70 / 0,47

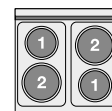

CFM4-68ET CUCINA ELETTRICA TRIFASE CON 4 PIASTRE Forno elettrico multifunzione camera cm. 64x37x35h, temp: 50÷250°C, con 1 griglia cm.53x32,5 GN1/1 - Porta vetro
06660832

EN Range threephase - N. 4 plates Multifunction electric oven Chamber cm. 64x37x35h, temp: 50÷250°C, with 1 grid cm.53x32,5 GN1/1 - Glass door • **DE** Elektroherd dreiphasig - N. 4 Kochplatten Multifunktions-Elektroofen cm. 64x37x35h, temp: 50÷250°C, mit 1 Rost cm.53x32,5 GN1/1 - Glastür • **FR** Cuisinière triphase - N. 4 plaques Four électrique à fonctions multiples cm. 64x37x35h, temp: 50÷250°C, avec 1 grille cm.53x32,5 GN1/1 - Porte vitrée • **ES COCINA TRIFÁSICA - N. 4 PLANCHAS HORNO ELÉCTRICO MULTIFUNCIONAL - CÁMARA CM. 64X37X35H, TEMP: 50÷250 °C, CON 1 PARILLA CM.53X32,5 GN1/1 - PUERTA VIDRIO cm. 80x 60x 90h**



⚡ 9,05 kW
400V~3N
230V~3
230V~
50/60 Hz

3.982,00
92 / 0,62

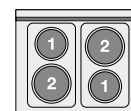

CFM4-68ET CUCINA ELETTRICA TRIFASE CON 4 PIASTRE Forno elettrico multifunzione camera cm. 64x37x35h, temp: 50÷250°C, con 1 griglia cm.53x32,5 GN1/1 - Porta cieca inox
06660833

EN Range threephase - N. 4 plates Multifunction electric oven Chamber cm. 64x37x35h, temp: 50÷250°C, with 1 grid cm.53x32,5 GN1/1 - Stainless steel door • **DE** Elektroherd dreiphasig - N. 4 Kochplatten Multifunktions-Elektroofen cm. 64x37x35h, temp: 50÷250°C, mit 1 Rost cm.53x32,5 GN1/1 - Edelstahltür • **FR** Cuisinière triphase - N. 4 plaques Four électrique à fonctions multiples cm. 64x37x35h, temp: 50÷250°C, avec 1 grille cm.53x32,5 GN1/1 - Porte acier inoxydable • **ES COCINA TRIFÁSICA - N. 4 PLANCHAS HORNO ELÉCTRICO MULTIFUNCIONAL - CÁMARA CM. 64X37X35H, TEMP: 50÷250 °C, CON 1 PARILLA CM.53X32,5 GN1/1 - PUERTA CIEGA INOX cm. 80x 60x 90h**



⚡ 9,05 kW
400V~3N
230V~3
230V~
50/60 Hz

3.982,00
92 / 0,62

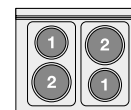

CUCINE ELETTRICHE

MOD. _____
COD. _____

DESCRIZIONE/DESCRIPTION/BEZEICHNUNG/DESCRIPTION/DESCRIPCIÓN
DIMENSIONI/DIMENSIONS/ABMESSUNGEN/DIMENSIONS/DIMENSIONES

POTENZA/POWER/LEISTUNG/PUISSANCE/POTENCIA
VOLTAGGIO/VOLTAGE/SPANNUNG/VOLTAGE/VOLTAJE

⚡ kW _____
kcal/h _____
V~ _____
Hz _____

PREZZO/PRICE €
PREIS/PRIX/PRECIO €
KG / M³

CFM6-610ET CUCINA ELETTRICA TRIFASE CON 6 PIASTRE Forno elettrico multifunzione camera cm. 64x37x35h, temp: 50÷250°C, con 1 griglia cm.53x32,5 GN1/1 - Porta vetro
06661032
EN Range threephase - N. 6 plates Multifunction electric oven Chamber cm. 64x37x35h, temp: 50÷250°C, with 1 grid cm.53x32,5 GN1/1 - Glass door • **DE** Elektroherd dreiphasig - N. 6 Kochplatten Multifunktions-Elektroofen cm. 64x37x35h, temp: 50÷250°C, mit 1 Rost cm.53x32,5 GN1/1 - Glastür • **FR** Cuisinière triphase - N. 6 plaques Four électrique à fonctions multiples cm. 64x37x35h, temp: 50÷250°C, avec 1 grille cm.53x32,5 GN1/1 - Porte vitrée • **ES** **COCINA TRIFÁSICA - N. 6 PLANCHAS HORNO ELÉCTRICO MULTIFUNCIONAL - CÁMARA CM. 64X37X35H, TEMP: 50÷250°C, CON 1 PARILLA CM.53X32,5 GN1/1 - PUERTA VIDRIO**
cm. 100x 60x 90h



⚡ 12,05 kW _____ **4.635,00**
400V~3N _____ 96 / 0,77
230V~3 _____
50/60 Hz _____



CFM6-610ET CUCINA ELETTRICA TRIFASE CON 6 PIASTRE Forno elettrico multifunzione camera cm. 64x37x35h, temp: 50÷250°C, con 1 griglia cm.53x32,5 GN1/1 - Porta cieca inox
06661032
EN Range threephase - N. 6 plates Multifunction electric oven Chamber cm. 64x37x35h, temp: 50÷250°C, with 1 grid cm.53x32,5 GN1/1 - Stainless steel door • **DE** Elektroherd dreiphasig - N. 6 Kochplatten Multifunktions-Elektroofen cm. 64x37x35h, temp: 50÷250°C, mit 1 Rost cm.53x32,5 GN1/1 - Edelstahltür • **FR** Cuisinière triphase - N. 6 plaques Four électrique à fonctions multiples cm. 64x37x35h, temp: 50÷250°C, avec 1 grille cm.53x32,5 GN1/1 - Porte acier inoxydable • **ES** **COCINA TRIFÁSICA - N. 6 PLANCHAS HORNO ELÉCTRICO MULTIFUNCIONAL - CÁMARA CM. 64X37X35H, TEMP: 50÷250°C, CON 1 PARILLA CM.53X32,5 GN1/1 - PUERTA CIEGA INOX**
cm. 100x 60x 90h

⚡ 12,05 kW _____ **4.635,00**
400V~3N _____ 96 / 0,77
230V~3 _____
50/60 Hz _____



CF4-68ET Cucina elettrica trifase con N. 4 piastre - Forno elettrico statico con grill cm. 64x42x35h, temp: 50÷250°C, con 1 griglia cm.53x32,5 GN1/1 - Porta vetro
06660830
EN Range threephase - N. 4 plates - Static oven with grill cm. 64x42x35h, temp: 50÷250°C, with 1 grid cm.53x32,5 GN1/1 - Glass door • **DE** Elektroherd dreiphasig - N. 4 Kochplatten Statischer Ofen mit Grill cm. 64x42x35h, temp: 50÷250°C, mit 1 Rost cm.53x32,5 GN1/1 - Glastür • **FR** Cuisinière triphase - N. 4 plaques - Four statique avec grill cm. 64x42x35h, temp: 50÷250°C, avec 1 grille cm.53x32,5 GN1/1 - Porte vitrée • **ES** **COCINA TRIFÁSICA - N. 4 PLANCHAS - HORNO ESTÁTICO CON ASADOR CM. 64X42X35H, TEMP: 50÷250°C, CON 1 PARILLA CM.53X32,5 GN1/1 - PUERTA VIDRIO**
cm. 80x 60x 90h



⚡ 8,62 kW _____ **2.955,00**
400V~3N _____ 91 / 0,62
230V~3 _____
230V~ _____
50/60 Hz _____



CF4-68ET Cucina elettrica trifase con N. 4 piastre - Forno elettrico statico con grill cm. 64x42x35h, temp: 50÷250°C, con 1 griglia cm.53x32,5 GN1/1 - Porta cieca inox
06660831
EN Range threephase - N. 4 plates - Static oven with grill cm. 64x42x35h, temp: 50÷250°C, with 1 grid cm.53x32,5 GN1/1 - Stainless steel door • **DE** Elektroherd dreiphasig - N. 4 Kochplatten Statischer Ofen mit Grill cm. 64x42x35h, temp: 50÷250°C, mit 1 Rost cm.53x32,5 GN1/1 - Edelstahltür • **FR** Cuisinière triphase - N. 4 plaques - Four statique avec grill cm. 64x42x35h, temp: 50÷250°C, avec 1 grille cm.53x32,5 GN1/1 - Porte acier inoxydable • **ES** **COCINA TRIFÁSICA - N. 4 PLANCHAS - HORNO ESTÁTICO CON ASADOR CM. 64X42X35H, TEMP: 50÷250°C, CON 1 PARILLA CM.53X32,5 GN1/1 - PUERTA CIEGA INOX**
cm. 80x 60x 90h



⚡ 8,62 kW _____ **2.955,00**
400V~3N _____ 91 / 0,62
230V~3 _____
230V~ _____
50/60 Hz _____

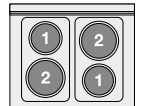

CUCINE ELETTRICHE

MOD. _____
COD. _____

DESCRIZIONE/DESCRIPTION/BEZEICHNUNG/DESCRIPTION/DESCRIPCIÓN
DIMENSIONI/DIMENSIONS/ABMESSUNGEN/DIMENSIONS/DIMENSIONES

POTENZA/POWER/LEISTUNG/PUISSANCE/POTENCIA
VOLTAGGIO/VOLTAGE/SPANNUNG/VOLTAGE/VOLTAGE

⚡ kW kcal/h
⚡ kW V~ Hz

PREZZO/PRICE €
PREIS/PRIX/PRECIO €
KG / M³

CF6-610ET
06661030

Cucina elettrica trifase con N. 6 piastre - Forno elettrico statico con grill cm. 64x42x35h, temp: 50÷250°C, con 1 griglia cm.53x32,5 GN1/1 - Porta vetro
EN Range threephase - N. 6 plates - Static oven with grill cm. 64x42x35h, temp: 50÷250°C, with 1 grid cm.53x32,5 GN1/1 - Glass door • **DE** Elektroherd dreiphasig - N. 6 Kochplatten Statischer Ofen mit Grill cm. 64x42x35h, temp: 50÷250°C, mit 1 Rost cm.53x32,5 GN1/1 - Glastür • **FR** Cuisinière triphase - N. 6 plaques - Four statique avec grill cm. 64x42x35h, temp: 50÷250°C, avec 1 grille cm.53x32,5 GN1/1 - Porte vitrée • **ES COCINA TRIFÁSICA - N. 6 PLANCHAS - HORNO ESTÁTICO CON ASADOR CM. 64X42X35H, TEMP: 50÷250°C, CON 1 PARILLA CM.53X32,5 GN1/1 - PUERTA VIDRIO**
cm. 100x 60x 90h



⚡ 11,62 kW **3.417,00**
400V~3N 95 / 0,77
230V~3
50/60 Hz



CF6-610ET
06661031

Cucina elettrica trifase con N. 6 piastre - Forno elettrico statico con grill cm. 64x42x35h, temp: 50÷250°C, con 1 griglia cm.53x32,5 GN1/1 - Porta cieca inox
EN Range threephase - N. 6 plates - Static oven with grill cm. 64x42x35h, temp: 50÷250°C, with 1 grid cm.53x32,5 GN1/1 - Stainless steel door • **DE** Elektroherd dreiphasig - N. 6 Kochplatten Statischer Ofen mit Grill cm. 64x42x35h, temp: 50÷250°C, mit 1 Rost cm.53x32,5 GN1/1 - Edelstahltür • **FR** Cuisinière triphase - N. 6 plaques - Four statique avec grill cm. 64x42x35h, temp: 50÷250°C, avec 1 grille cm.53x32,5 GN1/1 - Porte acier inoxydable • **ES COCINA TRIFÁSICA - N. 6 PLANCHAS - HORNO ESTÁTICO CON ASADOR CM. 64X42X35H, TEMP: 50÷250°C, CON 1 PARILLA CM.53X32,5 GN1/1 - PUERTA CIEGA INOX**
cm. 100x 60x 90h

⚡ 11,62 kW **3.417,00**
400V~3N 95 / 0,77
230V~3
50/60 Hz

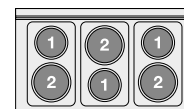

CFM4-66GEM
06690662

CUCINA MISTA 4 FUOCHI CON Forno elettrico multifunzione - Camera cm. 46x37x35h, temp: 50÷250°C, con 1 griglia cm.41x32,5 - Porta vetro
EN Combined range - N. 4 burners Multifunction oven - Chamber cm. 46x37x35h, temp: 50÷250°C, with 1 grid cm.41x32,5 - Glass door • **DE** Gemischtherd - N. 4 Kochstellen Multifunktions-Ofen - cm. 46x37x35h, temp: 50÷250°C, mit 1 Rost cm.41x32,5 - Glastür • **FR** Cuisinière mixte - N. 4 feux vifs Four à fonctions multiples - cm. 46x37x35h, temp: 50÷250°C, avec 1 grille cm.41x32,5 - Porte vitrée • **ES COCINA MIXTA - N. 4 QUEMADORES HORNO MULTIFUNCIONAL - CÁMARA CM. 46X37X35H, TEMP: 50÷250°C, CON 1 PARILLA CM.41X32,5 - PUERTA VIDRIO**
cm. 60x 60x 90h



⚡ 18 kW **3.715,00**
15.480 kcal/h 70 / 0,47
⚡ 3,05 kW
230V~
50/60 Hz

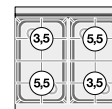

CFM4-66GEM
06690663

CUCINA MISTA 4 FUOCHI CON Forno elettrico multifunzione - Camera cm. 46x37x35h, temp: 50÷250°C, con 1 griglia cm.41x32,5 - Porta cieca inox
EN Combined range - N. 4 burners Multifunction oven - Chamber cm. 46x37x35h, temp: 50÷250°C, with 1 grid cm.41x32,5 - Stainless steel door • **DE** Gemischtherd - N. 4 Kochstellen Multifunktions-Ofen - cm. 46x37x35h, temp: 50÷250°C, mit 1 Rost cm.41x32,5 - Edelstahltür • **FR** Cuisinière mixte - N. 4 feux vifs Four à fonctions multiples - cm. 46x37x35h, temp: 50÷250°C, avec 1 grille cm.41x32,5 - Porte acier inoxydable • **ES COCINA MIXTA - N. 4 QUEMADORES HORNO MULTIFUNCIONAL - CÁMARA CM. 46X37X35H, TEMP: 50÷250°C, CON 1 PARILLA CM.41X32,5 - PUERTA CIEGA INOX**
cm. 60x 60x 90h



⚡ 18 kW **3.715,00**
15.480 kcal/h 70 / 0,47
⚡ 3,05 kW
230V~
50/60 Hz

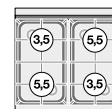

CFM4-68GEM
06690862

CUCINA MISTA 4 FUOCHI CON Forno elettrico multifunzione - Camera cm. 64x37x35h, temp: 50÷250°C, con 1 griglia cm.53x32,5 GN1/1 - Porta vetro
EN Combined range - N. 4 burners Multifunction oven - Chamber cm. 64x37x35h, temp: 50÷250°C, with 1 grid cm.53x32,5 GN1/1 - Glass door • **DE** Gemischtherd - N. 4 Kochstellen Multifunktions-Ofen cm. 64x37x35h, temp: 50÷250°C, with 1 grid cm.53x32,5 GN1/1 - Glastür • **FR** Cuisinière mixte - N. 4 feux vifs Four à fonctions multiples cm. 64x37x35h, temp: 50÷250°C, avec 1 grille cm.53x32,5 GN1/1 - Porte vitrée • **ES COCINA MIXTA - N. 4 QUEMADORES HORNO MULTIFUNCIONAL - CÁMARA CM. 64X37X35H, TEMP: 50÷250°C, CON 1 PARILLA CM.53X32,5 GN1/1 - PUERTA VIDRIO**
cm. 80x 60x 90h



⚡ 18 kW **4.818,00**
15.480 kcal/h 98 / 0,62
⚡ 3,05 kW
230V~
50/60 Hz

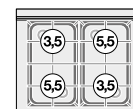

CUCINE A GAS CON FORNO ELETTRICO

MOD. _____
COD. _____

DESCRIZIONE/DESCRIPTION/BEZEICHNUNG/DESCRIPTION/DESCRIPCIÓN
DIMENSIONI/DIMENSIONS/ABMESSUNGEN/DIMENSIONS/DIMENSIONES

POTENZA/POWER/LEISTUNG/PUISSANCE/POTENCIA
VOLTAGGIO/VOLTAGE/SPANNUNG/VOLTAGE/VOLTAJE

kw kcal/h
V~ Hz

PREZZO/PRICE €
PREIS/PRIX/PRECIO €
KG / M³

CFM4-68GEM CUCINA MISTA 4 FUOCHI CON Forno elettrico multifunzione - Camera cm. 64x37x35h, temp: 50÷250°C, con 1 griglia cm.53x32,5 GN1/1 - Porta cieca inox
EN Combined range - N. 4 burners Multifunction oven - Chamber cm. 64x37x35h, temp: 50÷250°C, with 1 grid cm.53x32,5 GN1/1 - Stainless steel door • **DE** Gemischtherd - N. 4 Kochstellen Multifunktions-Ofen cm. 64x37x35h, temp: 50÷250°C, with 1 grid cm.53x32,5 GN1/1 - Edelstahltür • **FR** Cuisinière mixte - N. 4 feux vifs Four à fonctions multiples cm. 64x37x35h, temp: 50÷250°C, avec 1 grille cm.53x32,5 GN1/1 - Porte acier inoxydable • **ES COCINA MIXTA - N. 4 QUEMADORES HORNO MULTIFUNCIONAL - CÁMARA CM. 64X37X35H, TEMP: 50÷250°C, CON 1 PARILLA CM.53X32,5 GN1/1 - PUERTA CIEGA INOX cm. 80x 60x 90h**



18 kW 4.818,00
15.480 kcal/h 98 / 0,62
3,05 kW
230V~
50/60 Hz

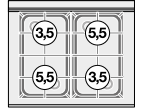

CFM6-610GEM CUCINA MISTA 6 FUOCHI CON Forno elettrico multifunzione - Camera cm. 64x37x35h, temp: 50÷250°C, con 1 griglia cm.53x32,5 GN1/1 - Porta vetro
EN Combined range - N. 6 burners Multifunction oven - Chamber cm. 64x37x35h, temp: 50÷250°C, with 1 grid cm.53x32,5 GN1/1 - Glass door • **DE** Gemischtherd - N. 6 Kochstellen Multifunktions-Ofen cm. 64x37x35h, temp: 50÷250°C, mit 1 Rost cm.53x32,5 GN1/1 - Glastür • **FR** Cuisinière mixte - N. 6 feux vifs Four à fonctions multiples cm. 64x37x35h, temp: 50÷250°C, avec 1 grille cm.53x32,5 GN1/1 - Porte vitrée • **ES COCINA MIXTA - N. 6 QUEMADORES HORNO MULTIFUNCIONAL - CÁMARA CM. 64X37X35H, TEMP: 50÷250°C, CON 1 PARILLA CM.53X32,5 GN1/1 - PUERTA VIDRIO cm. 100x 60x 90h**



27 kW 5.390,00
23.193 kcal/h 107 / 0,77
3,05 kW
230V~
50/60 Hz

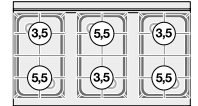

CFM6-610GEM CUCINA MISTA 6 FUOCHI CON Forno elettrico multifunzione - Camera cm. 64x37x35h, temp: 50÷250°C, con 1 griglia cm.53x32,5 GN1/1 - Porta cieca inox
EN Combined range - N. 6 burners Multifunction oven - Chamber cm. 64x37x35h, temp: 50÷250°C, with 1 grid cm.53x32,5 GN1/1 - Stainless steel door • **DE** Gemischtherd - N. 6 Kochstellen Multifunktions-Ofen cm. 64x37x35h, temp: 50÷250°C, mit 1 Rost cm.53x32,5 GN1/1 - Edelstahltür • **FR** Cuisinière mixte - N. 6 feux vifs Four à fonctions multiples cm. 64x37x35h, temp: 50÷250°C, avec 1 grille cm.53x32,5 GN1/1 - Porte acier inoxydable • **ES COCINA MIXTA - N. 6 QUEMADORES HORNO MULTIFUNCIONAL - CÁMARA CM. 64X37X35H, TEMP: 50÷250°C, CON 1 PARILLA CM.53X32,5 GN1/1 - PUERTA CIEGA INOX cm. 100x 60x 90h**



27 kW 5.390,00
23.193 kcal/h 107 / 0,77
3,05 kW
230V~
50/60 Hz

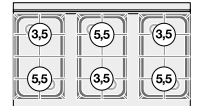

TPF4-610G TUTTA PIASTRA + 4 fuochi Forno a gas statico con grill cm. 64x39x35h, temp: 125÷275°C, con 1 griglia cm.53x32,5 GN1/1 - Piastra cm. 37x50 - Porta vetro
EN Solid top + 4 burners on Gas static oven with grill cm. 64x39x35h, temp: 125÷275°C, with 1 grid cm.53x32,5 GN1/1, Plate cm. 37x50 - Glass door • **DE** Kochplatte + 4 Gaskochstellen auf Gas statischer Backofen mit grill cm. 64x39x35h, temp: 125÷275°C, mit 1 Rost cm.53x32,5 GN1/1 Platte cm. 37x50 - Glastür • **FR** Toute plaque + 4 brûleurs sur Four gaz statique avec grill cm. 64x39x35h, temp: 125÷275°C, avec 1 grille cm.53x32,5 GN1/1 Plaque cm. 37x50 - Porte vitrée • **ES PLACA DE COCCIÓN + 4 FUEGOS CON HORNO GAS ESTÁTICO CON ASADOR CM. 64X39X35H, TEMP: 125÷275°C, CON 1 PARILLA CM.53X32,5 GN1/1, PLACA CM. 37X50 - PUERTA VIDRIO cm. 100x 60x 90h**



27,5 kW 5.443,00
23.650 kcal/h 165 / 0,77
0,015 kW
230V~
50/60 Hz

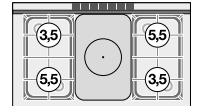

TPF4-610G TUTTA PIASTRA + 4 fuochi Forno a gas statico con grill cm. 64x39x35h, temp: 125÷275°C, con 1 griglia cm.53x32,5 GN1/1 - Piastra cm. 37x50 - Porta cieca inox
EN Solid top + 4 burners on Gas static oven with grill cm. 64x39x35h, temp: 125÷275°C, with 1 grid cm.53x32,5 GN1/1, Plate cm. 37x50 - Stainless steel door • **DE** Kochplatte + 4 Gaskochstellen auf Gas statischer Backofen mit grill cm. 64x39x35h, temp: 125÷275°C, mit 1 Rost cm.53x32,5 GN1/1 Platte cm. 37x50 - Edelstahltür • **FR** Toute plaque + 4 brûleurs sur Four gaz statique avec grill cm. 64x39x35h, temp: 125÷275°C, avec 1 grille cm.53x32,5 GN1/1 Plaque cm. 37x50 - Porte acier inoxydable • **ES PLACA DE COCCIÓN + 4 FUEGOS CON HORNO GAS ESTÁTICO CON ASADOR CM. 64X39X35H, TEMP: 125÷275°C, CON 1 PARILLA CM.53X32,5 GN1/1, PLACA CM. 37X50 - PUERTA CIEGA INOX cm. 100x 60x 90h**



27,5 kW 5.443,00
23.650 kcal/h 165 / 0,77
0,015 kW
230V~
50/60 Hz

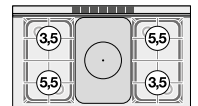

TUTTAPIASTRA A GAS CON FORNO ELETTRICO

MOD. _____
COD. _____

DESCRIZIONE/DESCRIPTION/BEZEICHNUNG/DESCRIPTION/DESCRIPCIÓN
DIMENSIONI/DIMENSIONS/ABMESSUNGEN/DIMENSIONS/DIMENSIONES

POTENZA/POWER/LEISTUNG/PUISSANCE/POTENCIA
VOLTAGGIO/VOLTAGE/SPANNUNG/VOLTAGE/VOLTAGE

kW kcal/h
V~
Hz

PREZZO/PRICE €
PREIS/PRIX/PRECIO €
KG / M³

TPF4-610GEM TUTTA PIASTRA + 4 FUOCHI CON Forno elettrico statico - camera cm. 06731060
64x42x35h, temp: 50÷250°C, con 1 griglia cm.53x32,5 GN1/1 - Piastra cm. 37x50 - Porta vetro
EN Solid top + 4 burners Traditional electric oven - chamber cm 64x42x35h, temp: 50÷250°C, with 1 grid cm.53x32,5 GN1/1, Plate cm. 37x50 - Glass door • **DE** Kochplatte + 4 Gaskochstellen Statischer elektro-backofen cm. 64x42x35h, temp: 50÷250°C, mit 1 Rost cm.53x32,5 GN1/1 Platte cm. 37x50 - Glastür • **FR** Toute plaque + 4 brûleurs vifs Four électrique statique chambre cm.64x42x35h, temp: 50÷250°C, avec 1 grille cm.53x32,5 GN1/1 Plaque cm. 37x50 - Porte vitrée • **ES PLACA DE COCCIÓN + 4 FUEGOS HORNO ELÉCTRICO ESTÁTICO CÁMARA CM. 64X42X35H, TEMP: 50÷250°C, CON 1 PARILLA CM.53X32,5 GN1/1, PLACA CM. 37X50 - PUERTA VIDRIO cm. 100x 60x 90h**



23,5 kW 5.195,00
20.210 kcal/h 165 / 0,77
2,62 kW
230V~
50/60 Hz

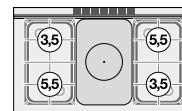

TPF4-610GEM TUTTA PIASTRA + 4 FUOCHI CON Forno elettrico statico - camera cm. 06731061
64x42x35h, temp: 50÷250°C, con 1 griglia cm.53x32,5 GN1/1 - Piastra cm. 37x50 - Porta cieca inox
EN Solid top + 4 burners Traditional electric oven - chamber cm 64x42x35h, temp: 50÷250°C, with 1 grid cm.53x32,5 GN1/1, Plate cm. 37x50 - Stainless steel door • **DE** Kochplatte + 4 Gaskochstellen Statischer elektro-backofen cm. 64x42x35h, temp: 50÷250°C, mit 1 Rost cm.53x32,5 GN1/1 Platte cm. 37x50 - Edelstahltür • **FR** Toute plaque + 4 brûleurs vifs Four électrique statique chambre cm.64x42x35h, temp: 50÷250°C, avec 1 grille cm.53x32,5 GN1/1 Plaque cm. 37x50 - Porte acier inoxydable • **ES PLACA DE COCCIÓN + 4 FUEGOS HORNO ELÉCTRICO ESTÁTICO CÁMARA CM. 64X42X35H, TEMP: 50÷250°C, CON 1 PARILLA CM.53X32,5 GN1/1, PLACA CM. 37X50 - PUERTA CIEGA INOX cm. 100x 60x 90h**



23,5 kW 5.195,00
20.210 kcal/h 165 / 0,77
2,62 kW
230V~
50/60 Hz

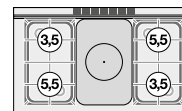

TPFM4-610GEM TUTTA PIASTRA + 4 FUOCHI CON Forno elettrico multifunzione cm. 06731062
64x37x35h, temp: 50÷250°C, con 1 griglia cm.53x32,5 GN1/1 - Piastra cm. 37x50 - Porta vetro
EN Solid top + 4 burners Multifunction electric oven cm. 64x37x35h, temp: 50÷250°C, with 1 grid cm.53x32,5 GN1/1, Plate cm. 37x50 - Glass door • **DE** Kochplatte + 4 Gaskochstellen Multifunktions-Elektroofen cm. 64x37x35h, temp: 50÷250°C, mit 1 Rost cm.53x32,5 GN1/1 Platte cm. 37x50 - Glastür • **FR** Toute plaque + 4 brûleurs vifs Four électrique à fonctions multiples cm. 64x37x35h, temp: 50÷250°C, avec 1 grille cm.53x32,5 GN1/1 Plaque cm. 37x50 - Porte vitrée • **ES PLACA DE COCCIÓN + 4 FUEGOS HORNO ELÉCTRICO MULTIFUNCIONAL CM. 64X37X35H, TEMP: 50÷250°C, CON 1 PARILLA CM.53X32,5 GN1/1, PLACA CM. 37X50 - PUERTA VIDRIO cm. 100x 60x 90h**



23,5 kW 6.699,00
20.210 kcal/h 166 / 0,77
3,05 kW
230V~
50/60 Hz

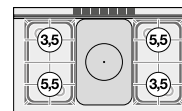

TPFM4-610GEM TUTTA PIASTRA + 4 FUOCHI CON Forno elettrico multifunzione cm. 06731063
64x37x35h, temp: 50÷250°C, con 1 griglia cm.53x32,5 GN1/1 - Piastra cm. 37x50 - Porta cieca inox
EN Solid top + 4 burners Multifunction electric oven cm. 64x37x35h, temp: 50÷250°C, with 1 grid cm.53x32,5 GN1/1, Plate cm. 37x50 - Stainless steel door • **DE** Kochplatte + 4 Gaskochstellen Multifunktions-Elektroofen cm. 64x37x35h, temp: 50÷250°C, mit 1 Rost cm.53x32,5 GN1/1 Platte cm. 37x50 - Edelstahltür • **FR** Toute plaque + 4 brûleurs vifs Four électrique à fonctions multiples cm. 64x37x35h, temp: 50÷250°C, avec 1 grille cm.53x32,5 GN1/1 Plaque cm. 37x50 - Porte acier inoxydable • **ES PLACA DE COCCIÓN + 4 FUEGOS HORNO ELÉCTRICO MULTIFUNCIONAL CM. 64X37X35H, TEMP: 50÷250°C, CON 1 PARILLA CM.53X32,5 GN1/1, PLACA CM. 37X50 - PUERTA CIEGA INOX cm. 100x 60x 90h**



23,5 kW 6.699,00
20.210 kcal/h 166 / 0,77
3,05 kW
230V~
50/60 Hz

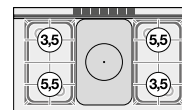

CUCINE ELETTRICHE

MOD. _____
COD. _____

DESCRIZIONE/DESCRIPTION/BEZEICHNUNG/DESCRIPTION/DESCRIPCIÓN
DIMENSIONI/DIMENSIONS/ABMESSUNGEN/DIMENSIONS/DIMENSIONES

POTENZA/POWER/LEISTUNG/PUISSANCE/POTENCIA
VOLTAGGIO/VOLTAGE/SPANNUNG/VOLTAGE/VOLTAJE

⚡ 9,05 kW
400V~3N
230V~3
230V~
50/60 Hz

PREZZO/PRICE €
PREIS/PRIX/PRECIO €
KG / M³

CFMC4-66ET CUCINA CON PIANO IN VETROCERAMICA Vetro cm. 58x44 Forno multifunzione - Camera cm. 46x37x35h, temp: 50÷250°C, con 1 griglia cm.41x32,5 - Porta vetro
EN Range threephase - Ceramic, Glass: cm. 58x44 Multifunction oven - Chamber cm. 46x37x35h, temp: 50÷250°C, with 1 grid cm.41x32,5 - Glass door • **DE** Elektroherd dreiphasig - Ceran-Kochfläche cm. 58x44 Multifunktions-Ofen - cm. 46x37x35h, temp: 50÷250°C, mit 1 Rost cm.41x32,5 - Glastür • **FR** Cuisinière triphase - Vitrocéramique Plaque cm. 58x44 Four à fonctions multiples - cm. 46x37x35h, temp: 50÷250°C, avec 1 grille cm.41x32,5 - Porte vitrée • **ES COCINA TRIFASICA - PLACA VITROCERÁMICA, CRISTAL CM. 58X44 HORNO MULTIFUNCIONAL - CÁMARA CM. 46X37X35H, TEMP: 50÷250°C, CON 1 PARILLA CM.41X32,5 - PUERTA VIDRIO cm. 60x 60x 90h**



⚡ 9,05 kW
400V~3N
230V~3
230V~
50/60 Hz

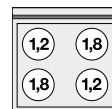

CFMC4-66ET CUCINA CON PIANO IN VETROCERAMICA Vetro cm. 58x44 Forno multifunzione - Camera cm. 46x37x35h, temp: 50÷250°C, con 1 griglia cm.41x32,5 - Porta cieca inox
EN Range threephase - Ceramic, Glass: cm. 58x44 Multifunction oven - Chamber cm. 46x37x35h, temp: 50÷250°C, with 1 grid cm.41x32,5 - Stainless steel door • **DE** Elektroherd dreiphasig - Ceran-Kochfläche cm. 58x44 Multifunktions-Ofen - cm. 46x37x35h, temp: 50÷250°C, mit 1 Rost cm.41x32,5 - Edelstahltür • **FR** Cuisinière triphase - Vitrocéramique Plaque cm. 58x44 Four à fonctions multiples - cm. 46x37x35h, temp: 50÷250°C, avec 1 grille cm.41x32,5 - Porte acier inoxydable • **ES COCINA TRIFASICA - PLACA VITROCERÁMICA, CRISTAL CM. 58X44 HORNO MULTIFUNCIONAL - CÁMARA CM. 46X37X35H, TEMP: 50÷250°C, CON 1 PARILLA CM.41X32,5 - PUERTA CIEGA INOX cm. 60x 60x 90h**



⚡ 9,05 kW
400V~3N
230V~3
230V~
50/60 Hz

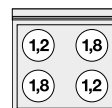

PT2/3-CFM66 Portateglie GN 2/3. per CFM-66
06460023 **EN** Frame for oven plates GN 2/3, for CFM-66 • **DE** Aufangeschienen für Backbleche GN 2/3 für CFM-66 • **FR** Kit porte-plaques GN 2/3 pour CFM-66 • **ES PORTACAZUELAS GN2/3 PARA CFM-66**

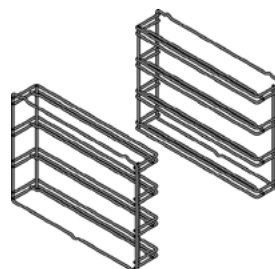

98,00
5 / 0,62

CF2-68G cucina a gas 2 fuochi Forno a gas statico con grill cm. 67x38x34h, temp: 125÷275°C, con 1 griglia cm.65x36
06780851 **EN** Gas range - N. 2 burners - Gas static oven with grill cm. 67x38x34h, temp: 125÷275°C, with 1 grid cm.65x36 • **DE** Gasherd - N. 2 Kochstellen - Gas statischer Backofen mit Grill cm. 67x38x34h, temp: 125÷275°C, mit 1 Rost cm.65x36 • **FR** Fourneau gaz - N. 2 feux vifs - Four a gaz statique avec grill cm. 67x38x34h, temp: 125÷275°C, avec 1 grille cm.65x36 • **ES COCINA GAS - N. 2 QUEMADORES HORNO A GAS ESTÁTICO CON ASADOR CM. 67X38X34H, TEMP: 125÷275°C, CON 1 PARILLA CM.65X36 cm. 80x 60x 90h**



⚡ 21 kW
18.060 kcal/h

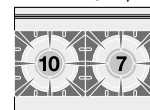

CF2-68GEM CUCINA MISTA 2 FUOCHI CON Forno elettrico statico con grill cm. 67x38x34h, temp: 50÷250°C, con 1 griglia cm.65x36
06790861 **EN** Combined range static oven - N. 2 burners Static oven cm. 67x38x34h, temp: 50÷250°C, with 1 grid cm.65x36 • **DE** Gemischtherd statischer Ofen - N. 2 Kochstellen Statisher Ofen cm. 67x38x34h, temp: 50÷250°C, mit 1 Rost cm.65x36 • **FR** Cuisinière mixte gaz four estatico - N. 2 feux vifs Four statique cm. 67x38x34h, temp: 50÷250°C, avec 1 grille cm.65x36 • **ES COCINA MIXTA HORNO ESTÁTICO - N. 2 QUEMADORES HORNO ESTÁTICO CM. 67X38X34H, TEMP: 50÷250°C, CON 1 PARILLA CM.65X36 cm. 80x 60x 90h**



⚡ 17 kW
14.620 kcal/h

⚡ 3,05 kW
230V~
50/60 Hz

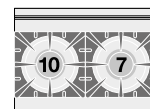

CUCINE A GAS CON FORNO ELETTRICO

MOD. _____
COD. _____

DESCRIZIONE/DESCRIPTION/BEZEICHNUNG/DESCRIPTION/DESCRIPCIÓN
DIMENSIONI/DIMENSIONS/ABMESSUNGEN/DIMENSIONS/DIMENSIONES

POTENZA/POWER/LEISTUNG/PUISSANCE/POTENCIA
VOLTAGGIO/VOLTAGE/SPANNUNG/VOLTAGE/VOLTAGE

⚡ kW
kcal/h

⚡ kW
V~
Hz

PREZZO/PRICE €
PREIS/PRIX/PRECIO €
KG / M³

CFM2-68GEM CUCINA MISTA 2 FUOCHI CON Forno elettrico multifunzione cm. 06790862 64x37x35h, temp: 50÷250°C, con 1 griglia cm.53x32,5 GN1/1 - Porta vetro
EN Combined range - N. 2 burners Multifunction electric oven cm. 64x37x35h, temp: 50÷250°C, with 1 grid cm.53x32,5 GN1/1 - Glass door • **DE** Gemischtherd - N. 2 Kochstellen Multifunktions-Elektroofen cm. 64x37x35h, temp: 50÷250°C, mit 1 Rost cm.53x32,5 GN1/1 - Glastür • **FR** Cuisinière mixte - N. 2 feux vifs Four électrique à fonctions multiples cm. 64x37x35h, temp: 50÷250°C, avec 1 grille cm.53x32,5 GN1/1 - Porte acier inoxydatable • **ES COCINA MIXTA - N. 2 QUEMADORES HORNO ELÉCTRICO MULTIFUNCIONAL CM. 64X37X35H, TEMP: 50÷250 °C, CON 1 PARILLA CM.53X32,5 GN1/1 - PUERTA CIEGA INOX cm. 80x 60x 90h**



⚡ 17 kW
14.620 kcal/h **4.531,00**
96 / 0,62
⚡ 3,05 kW
230V~
50/60 Hz

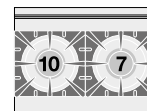

CFM2-68GEM CUCINA MISTA 2 FUOCHI CON Forno elettrico multifunzione cm. 06790863 64x37x35h, temp: 50÷250°C, con 1 griglia cm.53x32,5 GN1/1 - Porta cieca inox
EN Combined range - N. 2 burners Multifunction electric oven cm. 64x37x35h, temp: 50÷250°C, with 1 grid cm.53x32,5 GN1/1 - Stainless steel door • **DE** Gemischtherd - N. 2 Kochstellen Multifunktions-Elektroofen cm. 64x37x35h, temp: 50÷250°C, mit 1 Rost cm.53x32,5 GN1/1 - Edelstahltür • **FR** Cuisinière mixte - N. 2 feux vifs Four électrique à fonctions multiples cm. 64x37x35h, temp: 50÷250°C, avec 1 grille cm.53x32,5 GN1/1 - Porte acier inoxydatable • **ES COCINA MIXTA - N. 2 QUEMADORES HORNO ELÉCTRICO MULTIFUNCIONAL CM. 64X37X35H, TEMP: 50÷250 °C, CON 1 PARILLA CM.53X32,5 GN1/1 - PUERTA CIEGA INOX cm. 80x 60x 90h**



⚡ 17 kW
14.620 kcal/h **4.531,00**
96 / 0,62
⚡ 3,05 kW
230V~
50/60 Hz

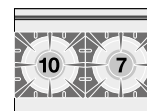

CF3-612GV cucina a gas 3 fuochi Forno a gas statico con grill cm. 06781251 125÷275°C, con 1 griglia cm.65x36, vano neutro con porta.
EN Gas range - N. 3 burners - Gas static oven with grill cm. 67x38x34h, temp: 125÷275°C, with 1 grid cm.65x36 - Neutral cabinet with door • **DE** Gasherd - N. 3 Kochstellen - Gas statischer Backofen mit Grill cm. 67x38x34h, temp: 125÷275°C, mit 1 Rost cm.65x36 - Neutrales Schrankelement mit Tür • **FR** Fourneau gaz - N. 3 feux vifs - Four a gaz statique avec grill cm. 67x38x34h, temp: 125÷275°C, avec 1 grille cm.65x36 - Element neutre avec porte • **ES COCINA GAS - N. 3 QUEMADORES HORNO A GAS ESTÁTICO CON ASADOR CM. 67X38X34H, TEMP: 125÷275 °C, CON 1 PARILLA CM.65X36 - ARMARIO NEUTRO CON PUERTA EQUIPADO cm. 120x 60x 90h**



⚡ 31 kW
26.660 kcal/h **4.968,00**
102 / 0,92

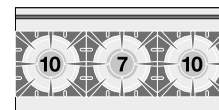

CF3-612GEMV CUCINA MISTA 3 FUOCHI CON Forno elettrico statico con grill cm. 06791261 67x38x34h, temp: 50÷250°C, con 1 griglia cm.65x36, vano neutro con porta
EN Combined range static oven - N. 3 burners Static oven cm. 67x38x34h, temp: 50÷250°C, with 1 grid cm.65x36 - Neutral cabinet with door • **DE** Gemischtherd statischer Ofen - N. 3 Kochstellen Statischer Ofen cm. 67x38x34h, temp: 50÷250°C, mit 1 Rost cm.65x36 - Neutrales Schrankelement mit Tür • **FR** Cuisinière mixte gaz four estatico - N. 3 feux vifs Four statique cm. 67x38x34h, temp: 50÷250°C, avec 1 grille cm.65x36 - Element neutre avec porte • **ES COCINA MIXTA HORNO ESTÁTICO - N. 3 QUEMADORES HORNO ESTÁTICO CM. 67X38X34H, TEMP: 50÷250 °C, CON 1 PARILLA CM.65X36 - ARMARIO NEUTRO CON PUERTA EQUIPADO cm. 120x 60x 90h**



⚡ 27 kW
23.220 kcal/h **5.058,00**
102 / 0,92
⚡ 3,05 kW
230V~
50/60 Hz

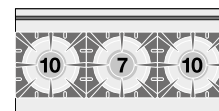

CFM3-612GEMV CUCINA MISTA 3 FUOCHI CON Forno elettrico multifunzione cm. 06791262 64x37x35h, temp: 50÷250°C, con 1 griglia cm.53x32,5 GN1/1 - Porta vetro - vano neutro con porta
EN Combined range - N. 3 burners Multifunction electric oven cm. 64x37x35h, temp: 50÷250°C, with 1 grid cm.53x32,5 GN1/1 - Glass door - Neutral cabinet with door • **DE** Gemischtherd - N. 3 Kochstellen Multifunktions-Elektroofen cm. 64x37x35h, temp: 50÷250°C, mit 1 Rost cm.53x32,5 GN1/1 - Glastür - Neutrales Schrankelement mit Tür • **FR** Cuisinière mixte - N. 3 feux vifs Four électrique à fonctions multiples cm. 64x37x35h, temp: 50÷250°C, avec 1 grille cm.53x32,5 GN1/1 - Porte acier inoxydatable - Element neutre avec porte • **ES COCINA MIXTA - N. 3 QUEMADORES HORNO ELÉCTRICO MULTIFUNCIONAL CM. 64X37X35H, TEMP: 50÷250 °C, CON 1 PARILLA CM.53X32,5 GN1/1 - PUERTA CIEGA INOX - ARMARIO NEUTRO CON PUERTA EQUIPADO cm. 120x 60x 90h**



⚡ 27 kW
23.220 kcal/h **5.433,00**
103 / 0,92
⚡ 3,05 kW
230V~
50/60 Hz

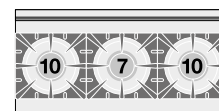

CUCINE A GAS CON FORNO ELETTRICO

MOD. _____
COD. _____

DESCRIZIONE/DESCRIPTION/BEZEICHNUNG/DESCRIPTION/DESCRIPCIÓN
DIMENSIONI/DIMENSIONS/ABMESSUNGEN/DIMENSIONS/DIMENSIONES

POTENZA/POWER/LEISTUNG/PUISSANCE/POTENCIA
VOLTAGGIO/VOLTAGE/SPANNUNG/VOLTAGE/VOLTAGE

⚡ kW kcal/h
⚡ V~ Hz

PREZZO/PRICE €
PREIS/PRIX/PRECIO €
KG / M³

CFM3-612GEMV CUCINA MISTA 3 FUOCHI CON Forno elettrico multifunzione cm. 64x37x35h, temp: 50÷250°C, con 1 griglia cm.53x32,5 GN1/1 - Porta cieca inox - vano neutro con porta
EN Combined range - N. 3 burners Multifunction electric oven cm. 64x37x35h, temp: 50÷250°C, with 1 grid cm.53x32,5 GN1/1 - Stainless steel door - Neutral cabinet with door • **DE** Gemischtherd - N. 3 Kochstellen Multifunktions-Elektroofen cm. 64x37x35h, temp: 50÷250°C, mit 1 Rost cm.53x32,5 GN1/1 - Edelstahltür - Neutrales Schrankelement mit Tür • **FR** Cuisinière mixte - N. 3 feux vifs Four électrique à fonctions multiples cm. 64x37x35h, temp: 50÷250°C, avec 1 grille cm.53x32,5 GN1/1 - Porte acier inoxydable - Element neutre avec porte • **ES** **COCINA MIXTA - N. 3 QUEMADORES HORNO ELÉCTRICO MULTIFUNCIONAL CM. 64X37X35H, TEMP: 50÷250 °C, CON 1 PARRILLA CM.53X32,5 GN1/1 - PUERTA CIEGA INOX - ARMARIO NEUTRO CON PUERTA EQUIPADO cm. 120x 60x 90h**



⚡ 27 kW 5.433,00
23.220 kcal/h 103 / 0,92

⚡ 3,05 kW
230V~
50/60 Hz

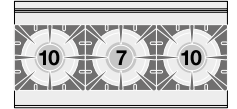

CPT-64ET CUOCIPASTA TRIFASE LT. 17 Vasca cm. 31x33,5x22h. Rubinetto scarico (CESTI ESCLUSI)
EN Pasta cooker threephase 17 lts. Tank cm. 31x33,5x22h. Drain-tap (BASKETS EXCLUDED) • **DE** Nudelkocher dreiphasig lt.17 Becken cm. 31x33,5x22h. Ablasshahn (KORB AUSGESCHLOSSEN) • **FR** Cuisieur à pâtes triphase lt.17 Cuve cm. 31x33,5x22h. Robinet de vidange (PANIERS EXCLUS) • **ES** **CUECE PASTA TRIFÁSICO LT.17 CUBA CM. 31X33,5X22H. GRIFO DESCARGA (CESTAS EXCLUIDAS) cm. 40x 60x 28h**



⚡ 4,1 kW 1.921,00
400V~3N 27 / 0,19
230V~
50/60 Hz

COMBINAZIONI

- Combinations / • Zusammenstellungen
- Combinaisons / • Combinación múltiple



CPT-66ET CUOCIPASTA TRIFASE LT. 25 Vasca cm. 51x31x22h. Rubinetto scarico (CESTI ESCLUSI)
EN Pasta cooker threephase 25 lts. Tank cm. 51x31x22h. Drain-tap (BASKETS EXCLUDED) • **DE** Nudelkocher dreiphasig lt.25 Becken cm. 51x31x22h. Ablasshahn (KORB AUSGESCHLOSSEN) • **FR** Cuisieur à pâtes triphase lt.25 Cuve cm. 51x31x22h. Robinet de vidange (PANIERS EXCLUS) • **ES** **CUECE PASTA TRIFÁSICO LT.25 CUBA CM. 51X31X22H. GRIFO DESCARGA (CESTAS EXCLUIDAS) cm. 60x 60x 28h**



⚡ 6,25 kW 2.134,00
400V~3N 42 / 0,28
50/60 Hz

COMBINAZIONI

- Combinations / • Zusammenstellungen
- Combinaisons / • Combinación múltiple



CPT-64G CUOCIPASTA A GAS CAPACITA' LT. 13 Vasca cm. 31x33,5x18h. Rubinetto scarico (CESTI ESCLUSI)
EN Gas pasta cookers Tank capacity 13 lts. Tank cm. 31x33,5x18h. Drain-tap (BASKETS EXCLUDED) • **DE** Gas -Nudelkocher Beckeninhalte lt.13 Becken cm. 31x33,5x18h. Ablasshahn (KORB AUSGESCHLOSSEN) • **FR** Cuisieur à pâtes gaz Cuve lt.13 Cuve cm. 31x33,5x18h. Robinet de vidange (PANIERS EXCLUS) • **ES** **CUECE PASTA GAS CUBA 13 LT. CUBA CM. 31X33,5X18H. GRIFO DESCARGA (CESTAS EXCLUIDAS) cm. 40x 60x 28h**



⚡ 6 kW 1.950,00
5.160 kcal/h 30 / 0,19

COMBINAZIONI

- Combinations / • Zusammenstellungen
- Combinaisons / • Combinación múltiple



CUOCIPASTA A GAS - TOP

MOD. _____
COD. _____

DESCRIZIONE/DESCRIPTION/BEZEICHNUNG/DESCRIPTION/DESCRIPCIÓN
DIMENSIONI/DIMENSIONS/ABMESSUNGEN/DIMENSIONS/DIMENSIONES

POTENZA/POWER/LEISTUNG/PUISSANCE/POTENCIA
VOLTAGGIO/VOLTAGE/SPANNUNG/VOLTAGE/VOLTAGE

9 kW
7.740 kcal/h

13,5 kW
400V~3N
50/60 Hz

PREZZO/PRICE €
PREIS/PRIX/PRECIO €
KG / M³

CPT-66G
16270650

CUOCIPASTA A GAS CAPACITA' LT. 19 Vasca cm. 51x31x18h. Rubinetto scarico (CESTI ESCLUSI)

EN Gas pasta cookers Tank capacity 19 lts. Tank cm. 51x31x18h. Drain-tap (BASKETS EXCLUDED) • **DE** Gas -Nudelkocher Beckeninhalt lt. 19 Becken cm. 51x31x18h. Ablasshahn (KORB AUSGESCHLOSSEN) • **FR** Cuiseur à pâtes gaz Cuve lt.19 Cuve cm. 51x31x18h. Robinet de vidange (PANIERS EXCLUS) • **ES CUECE PASTA GAS CUBA 19 LT. CUBA CM. 51X31X18H. GRIFO DESCARGA (CESTAS EXCLUIDAS) cm. 60x 60x 28h**



9 kW
7.740 kcal/h

2.296,00
45 / 0,28

COMBINAZIONI

- Combinations / • Zusammenstellungen
- Combinaisons / • Combinación múltiple



CP-66ET
06100630

CUOCIPASTA TRIFASE LT. 40 Vasca cm. 51x30,7x32,7h. Rubinetto carico acqua, sfioratore + scarico a pavimento (CESTI ESCLUSI)

EN Pasta cooker threephase 40 lts. - Tank cm. 51x30,7x32,7h. Water loading tap + overflow device and floor draining (BASKETS EXCLUDED) • **DE** Nudelkocher dreiphasig lt. 40 - Becken cm. 51x30,7x32,7h. Wasserlauf-Hahn + Überlauf-Vorrichtung und Ablauf am Boden (KORB AUSGESCHLOSSEN) • **FR** Cuiseur a pâtes triphase lt. 40 - Cuve cm. 51x30,7x32,7h. Robinet d'arrivée d'eau trop plein + système de vidange au sol (PANIERS EXCLUS) • **ES CUECE PASTA TRIFÁSICO LT. 40 - CUBA CM. 51X30,7X32,7H. GRIFO CARGA AGUA + VERTEDERO + DESCARGA A PAVIMENTO (CESTAS EXCLUIDAS) cm. 60x 60x 90h**



13,5 kW
400V~3N
50/60 Hz

3.718,00
81 / 0,47

COMBINAZIONI

- Combinations / • Zusammenstellungen
- Combinaisons / • Combinación múltiple



CPA-66ET
06100635

CUOCIPASTA TRIFASE LT. 40 Vasca cm. 51x30,7x32,7h. Carico acqua automatico con sensore di livello - sfioratore + scarico a pavimento (CESTI ESCLUSI)

EN Pasta cooker threephase 40 lts. - Tank cm. 51x30,7x32,7h. - Automatic Water loading with level sensor - overflow device and floor draining (BASKETS EXCLUDED) • **DE** Nudelkocher dreiphasig lt. 40 - Becken cm. 51x30,7x32,7h. Automatische Wasser Beladung mit Niveauregulierung + Überlauf-Vorrichtung und Ablauf am Boden (KORB AUSGESCHLOSSEN) • **FR** Cuiseur a pâtes triphase lt. 40 - Cuve cm. 51x30,7x32,7h. Chargement automatique de l'eau avec sensor de niveau, trop plein Système de vidange au sol (PANIERS EXCLUS) • **ES CUECE PASTA TRIFÁSICO LT. 40 - CUBA CM. 51X30,7X32,7H. CARGA AUTOMÁTICA DE AGUA CON SENSOR DE NIVEL + VERTEDERO + DESCARGA A PAVIMENTO. (CESTAS EXCLUIDAS) cm. 60x 60x 90h**



13,5 kW
400V~3N
50/60 Hz

4.225,00
82 / 0,47

COMBINAZIONI

- Combinations / • Zusammenstellungen
- Combinaisons / • Combinación múltiple



CUOCIPASTA A GAS

MOD. _____
COD. _____

DESCRIZIONE/DESCRIPTION/BEZEICHNUNG/DESCRIPTION/DESCRIPCIÓN
DIMENSIONI/DIMENSIONS/ABMESSUNGEN/DIMENSIONS/DIMENSIONES

POTENZA/POWER/LEISTUNG/PUISSANCE/POTENCIA
VOLTAGGIO/VOLTAGE/SPANNUNG/VOLTAGE/VOLTAGE

⚡ kW kcal/h
⚡ kW V~ Hz

PREZZO/PRICE €
PREIS/PRIX/PRECIO €
KG / M³

CP-66G
06270650

CUOCIPASTA GAS LT. 40 Vasca cm. 51x30,7x32,7h. Rubinetto carico acqua, sfioratore + scarico a pavimento (CESTI ESCLUSI)
EN Gas pasta cooker on cabinet Tank capacity 40 lts. cm. 51x30,7x32,7h. Water loading tap + overflow device and floor draining (BASKETS EXCLUDED) • **DE** Gas-Nudelkocher Standgerät - Inhalt lt. 40 cm. 51x30,7x32,7h. Wasserlauf-Hahn + Überlauf-Vorrichtung und Ablauf am Boden (KORB AUSGESCHLOSSEN) • **FR** Cuiseur a pates sur coffre gaz - Cuve lt. 40 cm. 51x30,7x32,7h. Robinet d'arrivée d'eau trop plein + système de vidange au sol (PANIERS EXCLUS) • **ES CUECE PASTA GAS - CUBA 40 LT. CM. 51X30,7X32,7H. GRIFO CARGA AGUA + VERTEDERO + DESCARGA A PAVIMENTO (CESTAS EXCLUIDAS)**
cm. 60x 60x 90h



⚡ 13,95 kW kcal/h **4.141,00**
11.997 kcal/h 84 / 0,47
⚡ 0,02 KW
230V~
50/60 Hz

COMBINAZIONI

- Combinations / • Zusammenstellungen
- Combinaisons / • Combinación múltiple



CPA-66G
06270655

CUOCIPASTA GAS LT. 40 Vasca cm. 51x30,7x32,7h. Carico acqua automatico con sensore di livello - sfioratore + scarico a pavimento (CESTI ESCLUSI)
EN Gas pasta cooker on cabinet Tank capacity 40 lts. cm. 51x30,7x32,7h. Automatic Water loading with level sensor - overflow device and floor draining (BASKETS EXCLUDED) • **DE** Gas-Nudelkocher Standgerät - Inhalt lt. 40 cm. 51x30,7x32,7h. Automatische Wasser Beladung mit Niveauregulierung + Überlauf-Vorrichtung und Ablauf am Boden (KORB AUSGESCHLOSSEN) • **FR** Cuiseur a pates sur coffre gaz - Cuve lt. 40 cm. 51x30,7x32,7h. Chargement automatique de l'eau avec sensor de niveau, trop plein Système de vidange au sol (PANIERS EXCLUS) • **ES CUECE PASTA GAS - CUBA 40 LT. CM. 51X30,7X32,7H. CARGA AUTOMÁTICA DE AGUA CON SENSOR DE NIVEL + VERTEDERO + DESCARGA A PAVIMENTO. (CESTAS EXCLUIDAS)**
cm. 60x 60x 90h



⚡ 13,95 kW kcal/h **4.427,00**
11.997 kcal/h 85 / 0,47
⚡ 0,035 KW
230V~
50/60 Hz

COMBINAZIONI

- Combinations / • Zusammenstellungen
- Combinaisons / • Combinación múltiple



CWKT-64ET
16080431

GRIGLIA CONTACT - cottura diretta su resistenza in acciaio inox cm. 27x35 ribaltabile
EN CONTACT Grill threephase - Stainless steel grill cm. 27x35 • **DE** Wurstbrater dreiphasig KONTAKT - Einstellbarer Rost aus Nirosta cm. 27x35 • **FR** Grillade triphase CONTACT - Grille inox cm 27x35 • **ES PARRILLA TRIFÁSICO CONTACT - PARRILLA DE ACERO INOX REGULABLE CM 27X35**
cm. 40x 60x 28h



⚡ 3,36 kW **2.810,00**
400V~3N 35 / 0,19
50/60 Hz

CWKT-68ET
16080831

GRIGLIA CONTACT - cottura diretta su resistenza in acciaio inox cm. 55x35 ribaltabile
EN CONTACT Grill threephase - Stainless steel grill cm. 55x35 • **DE** Wurstbrater dreiphasig KONTAKT - Einstellbarer Rost aus Nirosta cm. 55x35 • **FR** Grillade triphase CONTACT - Grille inox cm 55x35 • **ES PARRILLA TRIFÁSICO CONTACT - PARRILLA DE ACERO INOX REGULABLE CM 55X35**
cm. 80x 60x 28h

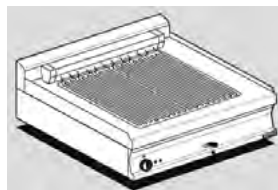

⚡ 6,72 kW **3.776,00**
400V~3N 50 / 0,37
50/60 Hz

GRIGLIE ELETTRICHE - TOP

MOD. COD.	DESCRIZIONE/DESCRIPTION/BEZEICHNUNG/DESCRIPTION/DESCRIPCIÓN DIMENSIONI/DIMENSIONS/ABMESSUNGEN/DIMENSIONS/DIMENSIONES	POTENZA/POWER/LEISTUNG/PUISSANCE/POTENCIA VOLTAGGIO/VOLTAGE/SPANNUNG/VOLTAGE/VOLTAGE	⚡ kcal/h	⚡ kw V~ Hz	PREZZO/PRICE € PREIS/PRIX/PRECIO € KG / M³
CWT-64ET 16080430	Griglia elettrica trifase Griglia in acciaio inox cm. 38x42,5 regolabile EN Grill threephase - Stainless steel grill cm. 38x42,5 • DE Wurstbrater dreiphasig Einstellbarer Rost aus Nirosta cm. 38x42,5 • FR Grillade Triphase - Grille inox cm. 38x42,5 • ES PARRILLA TRIFÁSICO PARRILLA DE ACERO INOX REGULABLE CM. 38X42,5 cm. 40x 60x 28h			4,8 kW 400V~3N 230V~3 50/60 Hz	1.976,00 36 / 0,19
CWT-66ET 16080630	Griglia elettrica trifase Griglia in acciaio inox cm. 58x42,5 regolabile EN Grill threephase - Stainless steel grill cm. 58x42,5 • DE Wurstbrater dreiphasig Einstellbarer Rost aus Nirosta cm. 58x42,5 • FR Grillade Triphase - Grille inox cm. 38x42,5 • ES PARRILLA TRIFÁSICO PARRILLA DE ACERO INOX REGULABLE CM. 58X42,5 cm. 60x 60x 28h			6,3 kW 400V~3N 230V~3 50/60 Hz	2.247,00 48 / 0,28
CWT-68ET 16080830	Griglia elettrica trifase N. 2 griglie in acciaio inox cm. 38x42,5 regolabili 2 zone di cottura EN Grill threephase - N. 2 Stainless steel grill cm. 38x42,5 2 cooking areas • DE Wurstbrater dreiphasig - N. 2 einstellbarer Rost aus Nirosta cm. 38x42,5 - 2 Heizzonen • FR Grillade Triphase - N. 2 grilles réglables en acier inox cm. 38x42,5 - 2 zones de cuisson • ES PARRILLA TRIFÁSICO - N. 2 PARRILLAS DE ACERO INOX REGULABLE CM. 38X42,5 - 2 ZONAS DE COCCIÓN cm. 80x 60x 28h			9,6 kW 400V~3N 230V~3 50/60 Hz	3.057,00 52 / 0,37
CWT-64G 16250450	Griglia a gas-pietralavica Griglia in acciaio inox cm. 38x42,5 regolabile EN Charcoal grill gas - Stainless steel grill cm. 38x42,5 • DE Gas-Lavasteingrill - Einstellbarer Rost aus Nirosta cm. 38x42,5 • FR Grille à gaz en pierre de lave - Grille inox cm. 38x42,5 • ES PARRILLA A GAS PIEDRA LÁVICA PARRILLA DE ACERO INOX REGULABLE CM. 38X42,5 cm. 40x 60x 28h			5,8 kW 4.988 kcal/h	2.065,00 41 / 0,19
CWT-66G 16250650	Griglia a gas-pietralavica Griglia in acciaio inox cm. 58x42,5 regolabile EN Charcoal grill gas - Stainless steel grill cm. 58x42,5 • DE Gas-Lavasteingrill - Einstellbarer Rost aus Nirosta cm. 58x42,5 • FR Grille à gaz en pierre de lave - Grille inox cm. 58x42,5 • ES PARRILLA A GAS PIEDRA LÁVICA PARRILLA DE ACERO INOX REGULABLE CM. 58X42,5 cm. 60x 60x 28h			8,9 kW 7.654 kcal/h	2.474,00 58 / 0,28
CWT-68G 16250850	Griglia a gas-pietralavica N. 2 griglie in acciaio inox cm. 38x42,5 regolabili - 2 zone di cottura EN Charcoal grill gas N. 2 Stainless steel grill cm. 38x42,5 - 2 cooking areas • DE Gas-Lavasteingrill N. 2 einstellbarer Rost aus Nirosta cm. 38x42,5 - Heizzonen • FR Grille à gaz en pierre de lave N. 2 grilles réglables en acier inox cm. 38x42,5 - 2 zones de cuisson • ES PARRILLA A GAS PIEDRA LÁVICA N. 2 PARRILLAS DE ACERO INOX REGULABLE CM. 38X42,5 - 2 ZONAS DE COCCIÓN cm. 80x 60x 28h			11,6 kW 9.976 kcal/h	3.325,00 62 / 0,37

FRIGGITRICI ELETTRICHE - TOP

MOD. _____
COD. _____

DESCRIZIONE/DESCRIPTION/BEZEICHNUNG/DESCRIPTION/DESCRIPCIÓN
DIMENSIONI/DIMENSIONS/ABMESSUNGEN/DIMENSIONS/DIMENSIONES

POTENZA/POWER/LEISTUNG/PUISSANCE/POTENCIA
VOLTAGGIO/VOLTAGE/SPANNUNG/VOLTAGE/VOLTAJE

⚡ kW _____
kcal/h _____
V~ _____
Hz _____

PREZZO/PRICE € _____
PREIS/PRIX/PRECIO € _____
KG / M³ _____

F10T-63EM
16090310

Friggitrice elettrica monofase - Vasca lt. 10 cm. 22x35x23h Con filtro e coperchio - Cesto cm. 20x30x10h Produzione patate 8 kg/h
EN Fryer singlephase - Tank capacity 10 Lst. cm. 22x35x23h - Sieve and lid for pan - Basket cm. 20x30x10h - Production 8 kg/hr • **DE** Friteuse einphasig - Beckeninhalte lt. 10 cm. 22x35x23h - Einlegesieb und Deckel für Becken - Korb cm. 20x30x10h Pommes frites: 8 kg/pro Stunde • **FR** Friteuse monophasé - Cuve lt. 10 cm. 22x35x23h - Filtre, couvercle pour cuve - Panier 20x30x10h Production de pommes frites: 8 kg/h • **ES FREIDORA MONOFÁSICA - CUBA 10 LT CM. 22X35X23H - FILTRO Y TAPA PARA CUBA - CESTA CM. 20X30X10H PRODUCCIÓN PATATAS 8 KG/H**
cm. 30x 60x 28h



⚡ 3,65 kW _____ **1.318,00**
230V~ _____ 20 / 0,15
50/60 Hz _____

F10T-63ET
16090330

Friggitrice elettrica trifase - Vasca Lt. 10 cm. 22x35x23h Con filtro e coperchio - Cesto cm. 20x30x10h Produzione patate 10 kg/h
EN Fryer threephase - Tank capacity 10 Lst. cm. 22x35x23h - Sieve and lid for pan - Basket cm. 20x30x10h - Production 10 kg/hr • **DE** Friteuse dreiphasing - Beckeninhalte lt. 10 cm. 22x35x23h - Einlegesieb und Deckel für Becken - Korb cm. 20x30x10h - Pommes frites: 10 kg/pro Stunde • **FR** Friteuse triphase - Cuve lt. 10 cm. 22x35x23h - Filtre, couvercle pour cuve - Panier 20x30x10h Production de pommes frites: 10 kg/h • **ES FREIDORA TRIFÁSICA - CUBA 10 LT CM. 22X35X23H - FILTRO Y TAPA PARA CUBA - CESTA CM. 20X30X10H PRODUCCIÓN PATATAS 10 KG/H**
cm. 30x 60x 28h

⚡ 7,15 kW _____ **1.526,00**
400V~3N _____ 21 / 0,15
230V~3 _____
50/60 Hz _____

F2/10T-66ET
16090630

Friggitrice elettrica trifase - Vasche Lt. 10+10 cm. 22x35x23h Con filtro e coperchio - N. 2 cesti cm. 20x30x10h Produzione patate 20 kg/h
EN Fryer threephase - Tank capacity 10+10 Lst. cm. 22x35x23h - Sieve and lid for pan - N. 2 baskets cm. 20x30x10h - Production 20 kg/hr • **DE** Friteuse dreiphasing - Beckeninhalte lt. 10+10cm. 22x35x23h - Einlegesieb und Deckel für Becken - N. 2 Körbe cm. 20x30x10h - Pommes frites: 20 kg/pro Stunde • **FR** Friteuse triphase - Cuves lt. 10+10 cm. 22x35x23h - Filtre, couvercle pour cuve - N. 2 paniers 20x30x10h Production de pommes frites: 20 kg/h • **ES FREIDORA TRIFÁSICA - CUBA 10+10 LT. CM. 22X35X23H - FILTRO Y TAPA PARA CUBA - N. 2 CESTAS CM. 20X30X10H PRODUCCIÓN PATATAS 20 KG/H**
cm. 60x 60x 28h



⚡ 14,3 kW _____ **2.700,00**
400V~3N _____ 37 / 0,28
230V~3 _____
50/60 Hz _____

F2/10T-66EM
16090610

Friggitrice elettrica monofase - Vasca lt. 10+10 cm. 22x35x23h Con filtro e coperchio - N. 2 cesti cm. 20x30x10h Produzione patate 16 kg/h
EN Fryer singlephase - Tank capacity 10+10 Lst. cm. 22x35x23h - Sieve and lid for pan - N. 2 baskets cm. 20x30x10h Production 16 kg/hr • **DE** Friteuse einphasig - Beckeninhalte lt. 10+10cm. 22x35x23h - Einlegesieb und Deckel für Becken - N. 2 Körbe cm. 20x30x10h Pommes frites: 16 kg/pro Stunde • **FR** Friteuse monophasé - Cuves lt. 10+10 cm. 22x35x23h - Filtre, couvercle pour cuve - N. 2 paniers 20x30x10h Production de pommes frites: 16 kg/h • **ES FREIDORA MONOFÁSICA - CUBA 10+10 LT. CM. 22X35X23H - FILTRO Y TAPA PARA CUBA - N. 2 CESTAS CM. 20X30X10H PRODUCCIÓN PATATAS 16 KG/H**
cm. 60x 60x 28h

⚡ 7,3 kW _____ **2.289,00**
230V~ _____ 34 / 0,28
50/60 Hz _____

F8T-63G
16260350

Friggitrice a gas - Vasca Lt. 8 cm. 22x27,5x22h - Con filtro e coperchio - cesto 20x24x9h - Produzione patate: 8 kg/h
EN Gas fryer - Tank capacity 8 lts. cm. 22x27,5x22h - Basket cm. 20x24x9h - Production: 8kg/h • **DE** Gas-einzelfriteuse - Beckeninhalte lt. 8 cm. 22x27,5x22h - Korb cm. 20x24x9h - Pommes frites: 8 kg/pro Stunde • **FR** Friteuse gaz - Cuve lt. 8 cm. 22x27,5x22h - Panier 20x24x9h Production de pommes frites: 8 kg/h • **ES FREIDORA GAS - CUBA 8 LT. CM. 22X27,5X22H - CESTA CM. 20X24X9H PRODUCCIÓN PATATAS: 8 KG/H**
cm. 30x 60x 28h



⚡ 6 kW _____ **1.826,00**
5.160 kcal/h _____ 23 / 0,15

FRIGGITRICI A GAS - TOP

MOD. _____ DESCRIZIONE/DESCRIPTION/BEZEICHNUNG/DESCRIPTION/DESCRIPCIÓN POTENZA/POWER/LEISTUNG/PUISSANCE/POTENCIA kW kcal/h PREZZO/PRICE €
 COD. _____ DIMENSIONI/DIMENSIONS/ABMESSUNGEN/DIMENSIONS/DIMENSIONES VOLTAGGIO/VOLTAGE/SPANNUNG/VOLTAGE/VOLTAJE V~ Hz PREIS/PRIX/PRECIO € KG / M³

F2/8T-66G Friggitrice a gas - Vasche Lt. 8+8 cm. 22x27,5x22h - Con filtro e
 16260650 coperchio - N. 2 cestì 20x24x9h - Produzione patate: 16 kg/h
EN Gas fryer - Tank capacity 8+8 lts. cm. 22x27,5x22h - N. 2 baskets cm. 20x24x9h Production: 16 kg/h • **DE** Gas-einzelfriteuse - Beckeninhalt lt. 8+8 cm. 22x27,5x22h - N. 2 Korbe cm. 20x24x9h Pommes frites: 16 kg/pro Stunde • **FR** Friteuse gaz - Cuve lt. 8+8 cm. 22x27,5x22h - N. 2 paniers 20x24x9h - Production de pommes frites: 16 kg/h • **ES FREIDORA GAS - CUBA 8+8 LT. CM. 22X27,5X22H - N. 2 CESTAS CM. 20X24X9H PRODUCCIÓN PATATAS: 16 KG/H**
cm. 60x 60x 28h



12 kW 3.171,00
 10.320 kcal/h 41 / 0,28

F13-64ET FRIGGITRICE TRIFASE LT. 13 Vasca cm. 24x35x32h - 1 cesto cm.
 06090430 21x30x12h - Filtro e coperchio vasca. Bacinella raccogliolio con filtro. - Produzione patate: 10 kg/h
EN Fryer threephase 13 lts - Bowl cm. 24x35x32h - 1 basket cm. 21x30x12h. Sieve and lid for pan. - Drip tray with sieve. Production: 10 kg/h • **DE** Friteuse dreiphasig lt. 13 - Becken cm. 24x35x32h - 1 Korb cm. 21x30x12h. Einlegesieb und Deckel für Becken. - Fettauffangschale mit Sieb. Pommes frites: 10 kg/h • **FR** Friteuse triphase lt. 13 - Cuve cm. 24x35x32h - 1 Panier cm. 21x30x12h. Filtre, couvercle pour cuve. - Bac de récupération de l'huile avec filtre. Production de pommes frites: 10 kg/h • **ES FREIDORAS TRIFÁSICO 13 LT. - CUBA CM. 24X35X32H - 1 CESTA CM. 21X30X12H. FILTRO Y TAPA PARA CUBA. BANDEJA RECOGE ACEITE CON FILTRO. PROD. PATATAS: 10 KG/H**
cm. 40x 60x 90h



10,95 kW 2.584,00
 400V~3N 52 / 0,37
 50/60 Hz

F13-64G Friggitrice gas LT. 13 Vasca cm. 32,5x31,5x36h - 1 cesto cm.
 06260450 30x27,5x12h - Filtro e coperchio vasca. Bacinella raccogliolio con filtro. - Produzione patate: 10 kg/h
EN Gas fryer 13 lts - Bowl cm. 32,5x31,5x36h - 1 basket cm. 30x27,5x12h. Sieve and lid for pan. - Drip tray with sieve. Production: 10 kg/h • **DE** Gas-Friteuse lt. 13 - Becken cm. 32,5x31,5x36h - 1 Korb cm. 30x27,5x12h. Einlegesieb und Deckel für Becken. - Fettauffangschale mit Sieb. Pommes frites: 10 kg/h • **FR** Friteuse a gaz lt. 13 - Cuve cm. 32,5x31,5x36h - 1 Panier cm. 30x27,5x12h. Filtre, couvercle pour cuve. - Bac de récupération de l'huile avec filtre. Production de pommes frites: 10 kg/h • **ES FREIDORAS A GAS 13 LT. - CUBA CM. 32,5X31,5X36H - 1 CESTA CM. 30X27,5X12H. FILTRO Y TAPA PARA CUBA. BANDEJA RECOGE ACEITE CON FILTRO. PROD. PATATAS: 10 KG/H**
cm. 40x 60x 90h



10,5 kW 2.914,00
 9.020 kcal/h 60 / 0,37

FTLT-64ET Fry-top elettrico liscio, piastra cm.39,5x45
 16060431 **EN** Electric Fry-top smooth griddle, plate cm.39,5x45 • **DE** Griddleplatte elektrische glatt, platte cm.39,5x45 • **FR** Plaque électriques lisse, plaque cm.39,5x45 • **ES FRY-TOP ELÉCTRICO LISO, PLANCHA CM.39,5X45**
cm. 40x 60x 28h



4,5 kW 1.417,00
 400V~3N 49 / 0,19
 230V~3 50/60 Hz

FTLT-64ETS Fry-top elettrico liscio cromato SUPERCHROME (Moca Approved), piastra
 16060434 cm.39,5x45
EN Electric Fry-top smooth chromed griddle SUPERCHROME (Moca Approved), plate cm.39,5x45 • **DE** Griddleplatte elektrische glatt hartverchromt SUPERCHROME (Moca Approved), platte cm.39,5x45 • **FR** Plaque électriques lisse chromée SUPERCHROME (Moca Approved), plaque cm.39,5x45 • **ES FRY-TOP ELÉCTRICO LISO CROMADO SUPERCHROME (MOCA APPROVED), PLANCHA CM.39,5X45**
cm. 40x 60x 28h

4,5 kW 1.945,00
 400V~3N 49 / 0,19
 230V~3 50/60 Hz

FTLT-64ETSS Fry-top elettrico liscio CROMO LUCIDO, piastra cm.39,5x45
 16060430 **EN** Electric Fry-top smooth POLISHED CHROME, plate cm.39,5x45 • **DE** Griddleplatte elektrische glatt POLIERTEM CHROM, platte cm.39,5x45 • **FR** Plaque électriques lisse CHROME POLI, plaque cm.39,5x45 • **ES FRY-TOP ELÉCTRICO LISO CROMO PULIDO, PLANCHA CM.39,5X45**
cm. 40x 60x 28h

4,5 kW 1.945,00
 400V~3N 49 / 0,19
 230V~3 50/60 Hz

Línea 60

FRY-TOP ELETTRICI - TOP

MOD. _____
COD. _____

DESCRIZIONE/DESCRIPTION/BEZEICHNUNG/DESCRIPTION/DESCRIPCIÓN
DIMENSIONI/DIMENSIONS/ABMESSUNGEN/DIMENSIONS/DIMENSIONES

POTENZA/POWER/LEISTUNG/PUISSANCE/POTENCIA
VOLTAGGIO/VOLTAGE/SPANNUNG/VOLTAGE/VOLTAJE

⚡ kW kcal/h
⚡ kw V- Hz

PREZZO/PRICE €
PREIS/PRIX/PRECIO €
KG / M²

FTRT-64ET
16060433

Fry-top elettrico rigato, piastra cm.39,5x45
EN Electric Fry-top grooved griddle, plate cm.39,5x45 • **DE** Griddleplatte elektrische gerillt, platte cm.39,5x45 • **FR** Plaque électriques nervurée, plaque cm.39,5x45 • **ES FRY-TOP ELÉCTRICO ESTRIADO, PLANCHA CM.39,5X45**
cm. 40x 60x 28h

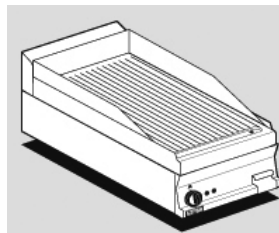

⚡ 4,5 kW **1.628,00**
400V~3N 49 / 0,19
230V~3
50/60 Hz



FTRT-64ETS
16060436

Fry-top elettrico rigato cromato SUPERCHROME (Moca Approved), piastra cm.39,5x45
EN Electric Fry-top grooved chromed griddle SUPERCHROME (Moca Approved), plate cm.39,5x45 • **DE** Griddleplatte elektrische gerillt hartverchromt SUPERCHROME (Moca Approved), platte cm.39,5x45 • **FR** Plaque électriques nervurée chromée SUPERCHROME (Moca Approved), plaque cm.39,5x45 • **ES FRY-TOP ELÉCTRICO ESTRIADO CROMADO SUPERCHROME (MOCA APPROVED), PLANCHA CM.39,5X45**
cm. 40x 60x 28h

⚡ 4,5 kW **2.132,00**
400V~3N 49 / 0,19
230V~3
50/60 Hz



FTLT-66ET
16060631

Fry-top elettrico liscio, piastra cm.59,5x45 - 2 zone di cottura
EN Electric Fry-top smooth griddle, plate cm.59,5x45 - 2 cooking areas • **DE** Griddleplatte elektrische glatt, platte cm.59,5x45 - 2 Heizzonen • **FR** Plaque électriques lisse, plaque cm.59,5x45 - 2 zones de cuisson • **ES FRY-TOP ELÉCTRICO LISO, PLANCHA CM.59,5X45 - 2 ZONAS DE COCCIÓN**
cm. 60x 60x 28h



⚡ 6,75 kW **1.860,00**
400V~3N 66 / 0,28
230V~3
50/60 Hz



FTLT-66ETS
16060634

Fry-top elettrico liscio cromato SUPERCHROME (Moca Approved), piastra cm.59,5x45 - 2 zone di cottura
EN Electric Fry-top smooth chromed griddle SUPERCHROME (Moca Approved), plate cm.59,5x45 - 2 cooking areas • **DE** Griddleplatte elektrische glatt hartverchromt SUPERCHROME (Moca Approved), platte cm.59,5x45 - 2 Heizzonen • **FR** Plaque électriques lisse chromée SUPERCHROME (Moca Approved), plaque cm.59,5x45 - 2 zones de cuisson • **ES FRY-TOP ELÉCTRICO LISO CROMADO SUPERCHROME (MOCA APPROVED), PLANCHA CM.59,5X45 - 2 ZONAS DE COCCIÓN**
cm. 60x 60x 28h

⚡ 6,75 kW **2.516,00**
400V~3N 66 / 0,28
230V~3
50/60 Hz



FTLT-66ETSS
16060630

Fry-top elettrico liscio CROMO LUCIDO, piastra cm.59,5x45 - 2 zone di cottura
EN Electric Fry-top smooth POLISHED CHROME, plate cm.59,5x45 - 2 cooking areas • **DE** Griddleplatte elektrische glatt POLIERTEM CHROM, platte cm.59,5x45 - 2 Heizzonen • **FR** Plaque électriques lisse CHROME POLI, plaque cm.59,5x45 - 2 zones de cuisson • **ES FRY-TOP ELÉCTRICO LISO CROMO PULIDO, PLANCHA CM.59,5X45 - 2 ZONAS DE COCCIÓN**
cm. 60x 60x 28h

⚡ 6,75 kW **2.516,00**
400V~3N 66 / 0,28
230V~3
50/60 Hz



FRY-TOP ELETTRICI - TOP

MOD. _____
COD. _____

DESCRIZIONE/DESCRIPTION/BEZEICHNUNG/DESCRIPTION/DESCRIPCIÓN
DIMENSIONI/DIMENSIONS/ABMESSUNGEN/DIMENSIONS/DIMENSIONES

POTENZA/POWER/LEISTUNG/PUISSANCE/POTENCIA
VOLTAGGIO/VOLTAGE/SPANNUNG/VOLTAGE/VOLTAGE

6,75 kW
kcal/h

400V~3N
230V~3
50/60 Hz

PREZZO/PRICE €
PREIS/PRIX/PRECIO €
KG / M³

FTLRT-66ET Fry-top elettrico 1/2 rigato + 1/2 liscio, piastra cm.59,5x45 - 2 zone di cottura
16060632
EN Electric Fry-top 1/2 grooved + 1/2 smooth, plate cm.59,5x45 - 2 cooking areas • **DE** Griddleplatte elektrische 1/2 gerillt + 1/2 glatt, platte cm.59,5x45 - 2 Heizzonen • **FR** Plaque électriques 1/2 nervurée + 1/2 lisse, plaque cm.59,5x45 - 2 zones de cuisson • **ES FRY-TOP ELÉCTRICO 1/2 ESTRIADO + 1/2 LISO, PLANCHA CM.59,5X45 - 2 ZONAS DE COCCIÓN**
cm. 60x 60x 28h

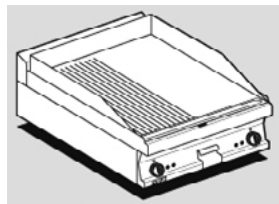

6,75 kW **2.025,00**
400V~3N 66 / 0,28
230V~3
50/60 Hz

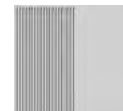

FTLRT-66ETS Fry-top elettrico 1/2 rigato + 1/2 liscio cromato SUPERCHROME (Moca Approved), piastra cm.59,5x45 - 2 zone di cottura
16060635
EN Electric Fry-top 1/2 grooved + 1/2 smooth chromed griddle SUPERCHROME (Moca Approved), plate cm.59,5x45 - 2 cooking areas • **DE** Griddleplatte elektrische 1/2 gerillt + 1/2 glatt hartverchromt SUPERCHROME (Moca Approved), platte cm.59,5x45 - 2 Heizzonen • **FR** Plaque électriques 1/2 nervurée + 1/2 lisse chromée SUPERCHROME (Moca Approved), plaque cm.59,5x45 - 2 zones de cuisson • **ES FRY-TOP ELÉCTRICO 1/2 ESTRIADO + 1/2 LISO CROMADO SUPERCHROME (MOCA APPROVED), PLANCHA CM.59,5X45 - 2 ZONAS DE COCCIÓN**
cm. 60x 60x 28h

6,75 kW **2.690,00**
400V~3N 66 / 0,28
230V~3
50/60 Hz

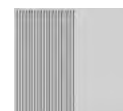

FTRT-66ET Fry-top elettrico rigato, piastra cm.59,5x45 - 2 zone di cottura
16060633
EN Electric Fry-top grooved griddle, plate cm.59,5x45 - 2 cooking areas • **DE** Griddleplatte elektrische gerillt, platte cm.59,5x45 - 2 Heizzonen • **FR** Plaque électriques nervurée, plaque cm.59,5x45 - 2 zones de cuisson • **ES FRY-TOP ELÉCTRICO ESTRIADO, PLANCHA CM.59,5X45 - 2 ZONAS DE COCCIÓN**
cm. 60x 60x 28h



6,75 kW **2.214,00**
400V~3N 66 / 0,28
230V~3
50/60 Hz

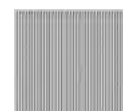

FTRT-66ETS Fry-top elettrico rigato cromato SUPERCHROME (Moca Approved), piastra cm.59,5x45 - 2 zone di cottura
16060636
EN Electric Fry-top grooved chromed griddle SUPERCHROME (Moca Approved), plate cm.59,5x45 - 2 cooking areas • **DE** Griddleplatte elektrische gerillt hartverchromt SUPERCHROME (Moca Approved), platte cm.59,5x45 - 2 Heizzonen • **FR** Plaque électriques nervurée chromée SUPERCHROME (Moca Approved), plaque cm.59,5x45 - 2 zones de cuisson • **ES FRY-TOP ELÉCTRICO ESTRIADO CROMADO SUPERCHROME (MOCA APPROVED), PLANCHA CM.59,5X45 - 2 ZONAS DE COCCIÓN**
cm. 60x 60x 28h

6,75 kW **2.872,00**
400V~3N 66 / 0,28
230V~3
50/60 Hz

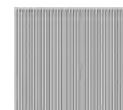

FRY-TOP ELETTRICI - TOP

MOD. _____
COD. _____

DESCRIZIONE/DESCRIPTION/BEZEICHNUNG/DESCRIPTION/DESCRIPCIÓN
DIMENSIONI/DIMENSIONS/ABMESSUNGEN/DIMENSIONS/DIMENSIONES

POTENZA/POWER/LEISTUNG/PUISSANCE/POTENCIA
VOLTAGGIO/VOLTAGE/SPANNUNG/VOLTAGE/VOLTAJE

9 kW
kcal/h
V-
Hz

PREZZO/PRICE €
PREIS/PRIX/PRECIO
KG / M³

FTLT-68ET
16060831

Fry-top elettrico liscio, piastra cm.79,5x45 - 2 zone di cottura
EN Electric Fry-top smooth griddle, plate cm.79,5x45 - 2 cooking areas
• **DE** Griddleplatte elektrische glatt, platte cm.79,5x45 - 2 Heizzonen
• **FR** Plaque électriques lisse, plaque cm.79,5x45 - 2 zones de cuisson
• **ES FRY-TOP ELÉCTRICO LISO, PLANCHA CM.79,5X45 - 2 ZONAS DE COCCIÓN**
cm. 80x 60x 28h

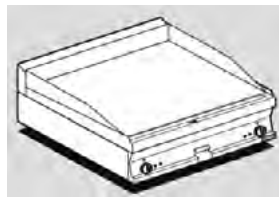

9 kW **2.740,00**
400V~3N 81 / 0,37
230V~3
50/60 Hz



FTLT-68ETS
16060834

Fry-top elettrico liscio cromato SUPERCHROME (Moca Approved), piastra cm.79,5x45 - 2 zone di cottura
EN Electric Fry-top smooth chromed griddle SUPERCHROME (Moca Approved), plate cm.79,5x45 - 2 cooking areas • **DE** Griddleplatte elektrische glatt hartverchromt SUPERCHROME (Moca Approved), platte cm.79,5x45 - 2 Heizzonen • **FR** Plaque électriques lisse chromée SUPERCHROME (Moca Approved), plaque cm.79,5x45 - 2 zones de cuisson • **ES FRY-TOP ELÉCTRICO LISO CROMADO SUPERCHROME (MOCA APPROVED), PLANCHA CM.79,5X45 - 2 ZONAS DE COCCIÓN**
cm. 80x 60x 28h

9 kW **3.360,00**
400V~3N 81 / 0,37
230V~3
50/60 Hz



FTLT-68ETSS
16060830

Fry-top elettrico liscio CROMO LUCIDO, piastra cm.79,5x45 - 2 zone di cottura
EN Electric Fry-top smooth POLISHED CHROME, plate cm.79,5x45 - 2 cooking areas • **DE** Griddleplatte elektrische glatt POLIERTEM CHROM, platte cm.79,5x45 - 2 Heizzonen • **FR** Plaque électriques lisse CHROME POLI, plaque cm.79,5x45 - 2 zones de cuisson • **ES FRY-TOP ELÉCTRICO LISO CROMO PULIDO, PLANCHA CM.79,5X45 - 2 ZONAS DE COCCIÓN**
cm. 80x 60x 28h

9 kW **3.360,00**
400V~3N 81 / 0,37
230V~3
50/60 Hz



FTLRT-68ET
16060832

Fry-top elettrico 1/2 rigato + 1/2 liscio, piastra cm.79,5x45 - 2 zone di cottura
EN Electric Fry-top 1/2 grooved + 1/2 smooth, plate cm.79,5x45 - 2 cooking areas • **DE** Griddleplatte elektrische 1/2 gerillt + 1/2 glatt, platte cm.79,5x45 - 2 Heizzonen • **FR** Plaque électriques 1/2 nervurée + 1/2 lisse, plaque cm.79,5x45 - 2 zones de cuisson • **ES FRY-TOP ELÉCTRICO 1/2 ESTRIADO + 1/2 LISO, PLANCHA CM.79,5X45 - 2 ZONAS DE COCCIÓN**
cm. 80x 60x 28h



9 kW **2.915,00**
400V~3N 81 / 0,37
230V~3
50/60 Hz



FTLRT-68ETS
16060835

Fry-top elettrico 1/2 rigato + 1/2 liscio cromato SUPERCHROME (Moca Approved), piastra cm.79,5x45 - 2 zone di cottura
EN Electric Fry-top 1/2 grooved + 1/2 smooth chromed griddle SUPERCHROME (Moca Approved), plate cm.79,5x45 - 2 cooking areas
• **DE** Griddleplatte elektrische 1/2 gerillt + 1/2 glatt hartverchromt SUPERCHROME (Moca Approved), platte cm.79,5x45 - 2 Heizzonen
• **FR** Plaque électriques 1/2 nervurée + 1/2 lisse chromée SUPERCHROME (Moca Approved), plaque cm.79,5x45 - 2 zones de cuisson • **ES FRY-TOP ELÉCTRICO 1/2 ESTRIADO + 1/2 LISO CROMADO SUPERCHROME (MOCA APPROVED), PLANCHA CM.79,5X45 - 2 ZONAS DE COCCIÓN**
cm. 80x 60x 28h

9 kW **3.535,00**
400V~3N 81 / 0,37
230V~3
50/60 Hz



FRY-TOP ELETTRICI - TOP

MOD. _____
COD. _____

DESCRIZIONE/DESCRIPTION/BEZEICHNUNG/DESCRIPCIÓN/DESCRIPCIÓN
DIMENSIONI/DIMENSIONS/ABMESSUNGEN/DIMENSIONS/DIMENSIONES

POTENZA/POWER/LEISTUNG/PUISSANCE/POTENCIA
VOLTAGGIO/VOLTAGE/SPANNUNG/VOLTAGE/VOLTAGE

⚡ kW kcal/h ⚡ kW
V~ Hz

PREZZO/PRICE €
PREIS/PRIX/PRECIO €
KG / M³

FTRT-68ET
16060833

Fry-top elettrico rigato, piastra cm.79,5x45 - 2 zone di cottura
EN Electric Fry-top grooved griddle, plate cm.79,5x45 - 2 cooking areas
• **DE** Griddleplatte elektrische gerillt, platte cm.79,5x45 - 2 Heizzonen
• **FR** Plaque électriques nervurée, plaque cm.79,5x45 - 2 zones de cuisson • **ES FRY-TOP ELÉCTRICO ESTRIADO, PLANCHA CM.79,5X45 - 2 ZONAS DE COCCIÓN**

cm. 80x 60x 28h

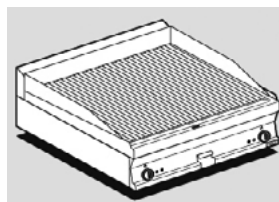

⚡ 9 kW **3.087,00**
400V~3N 81 / 0,37
230V~3
50/60 Hz



FTRT-68ETS
16060836

Fry-top elettrico rigato cromato SUPERCHROME (Moca Approved), piastra cm.79,5x45 - 2 zone di cottura
EN Electric Fry-top grooved chromed griddle SUPERCHROME (Moca Approved), plate cm.79,5x45 - 2 cooking areas • **DE** Griddleplatte elektrische gerillt hartverchromt SUPERCHROME (Moca Approved), platte cm.79,5x45 - 2 Heizzonen • **FR** Plaque électriques nervurée chromée SUPERCHROME (Moca Approved), plaque cm.79,5x45 - 2 zones de cuisson • **ES FRY-TOP ELÉCTRICO ESTRIADO CROMADO SUPERCHROME (MOCA APPROVED), PLANCHA CM.79,5X45 - 2 ZONAS DE COCCIÓN**

cm. 80x 60x 28h

⚡ 9 kW **3.712,00**
400V~3N 81 / 0,37
230V~3
50/60 Hz



FTLT-610ET
16061031

Fry-top elettrico liscio, piastra cm.99,5x45 - 2 zone di cottura
EN Electric Fry-top smooth griddle, plate cm.99,5x45 - 2 cooking areas
• **DE** Griddleplatte elektrische glatt, platte cm.99,5x45 - 2 Heizzonen
• **FR** Plaque électriques lisse, plaque cm.99,5x45 - 2 zones de cuisson • **ES FRY-TOP ELÉCTRICO LISO, PLANCHA CM.99,5X45 - 2 ZONAS DE COCCIÓN**

cm. 100x 60x 28h



⚡ 11,25 kW **3.118,00**
400V~3N 88 / 0,46
50/60 Hz



FTLT-610ETS
16061034

Fry-top elettrico liscio cromato SUPERCHROME (Moca Approved), piastra cm.99,5x45 - 2 zone di cottura
EN Electric Fry-top smooth chromed griddle SUPERCHROME (Moca Approved), plate cm.99,5x45 - 2 cooking areas • **DE** Griddleplatte elektrische glatt hartverchromt SUPERCHROME (Moca Approved), platte cm.99,5x45 - 2 Heizzonen • **FR** Plaque électriques lisse chromée SUPERCHROME (Moca Approved), plaque cm.99,5x45 - 2 zones de cuisson • **ES FRY-TOP ELÉCTRICO LISO CROMADO SUPERCHROME (MOCA APPROVED), PLANCHA CM.99,5X45 - 2 ZONAS DE COCCIÓN**

cm. 100x 60x 28h

⚡ 11,25 kW **3.713,00**
400V~3N 88 / 0,46
50/60 Hz



FTLT-610ETSS
16061030

Fry-top elettrico liscio CROMO LUCIDO, piastra cm.99,5x45 - 2 zone di cottura
EN Electric Fry-top smooth POLISHED CHROME, plate cm.99,5x45 - 2 cooking areas • **DE** Griddleplatte elektrische glatt POLIERTEM CHROM, platte cm.99,5x45 - 2 Heizzonen • **FR** Plaque électriques lisse CHROME POLI, plaque cm.99,5x45 - 2 zones de cuisson • **ES FRY-TOP ELÉCTRICO LISO CROMO PULIDO, PLANCHA CM.99,5X45 - 2 ZONAS DE COCCIÓN**

cm. 100x 60x 28h

⚡ 11,25 kW **3.713,00**
400V~3N 88 / 0,46
50/60 Hz



FRY-TOP A GAS - TOP

MOD. _____
COD. _____

DESCRIZIONE/DESCRIPTION/BEZEICHNUNG/DESCRIPTION/DESCRIPCIÓN
DIMENSIONI/DIMENSIONS/ABMESSUNGEN/DIMENSIONS/DIMENSIONES

POTENZA/POWER/LEISTUNG/PUISSANCE/POTENCIA
VOLTAGGIO/VOLTAGE/SPANNUNG/VOLTAGE/VOLTAJE

⚡ kW kcal/h
⚡ V~ Hz

PREZZO/PRICE €
PREIS/PRIX/PRECIO €
KG / M³

FTLRT-610ET Fry-top elettrico 2/5 rigato + 3/5 liscio, piastra cm.99,5x45 - 2 zone di cottura
16061032
EN Electric Fry-top 2/5 grooved + 3/5 smooth, plate cm.99,5x45 - 2 cooking areas • **DE** Griddleplatte elektrische 2/5 gerillt + 3/5 glatt, platte cm.99,5x45 - 2 Heizzonen • **FR** Plaque électriques 2/5 nervurée + 3/5 lisse, plaque cm.99,5x45 - 2 zones de cuisson • **ES FRY-TOP ELÉCTRICO 2/5 ESTRIADO + 3/5 LISO, PLANCHA CM.99,5X45 - 2 ZONAS DE COCCIÓN**
cm. 100x 60x 28h



⚡ 11,25 kW **3.307,00**
400V~3N 88 / 0,46
50/60 Hz



FTLRT-610ETS Fry-top elettrico 2/5 rigato + 3/5 liscio cromato SUPERCHROME (Moca Approved), piastra cm.99,5x45 - 2 zone di cottura
16061035
EN Electric Fry-top 2/5 grooved + 3/5 smooth chromed griddle SUPERCHROME (Moca Approved), plate cm.99,5x45 - 2 cooking areas • **DE** Griddleplatte elektrische 2/5 gerillt + 3/5 glatt hartverchromt SUPERCHROME (Moca Approved), platte cm.99,5x45 - 2 Heizzonen • **FR** Plaque électriques 2/5 nervurée + 3/5 lisse chromée SUPERCHROME (Moca Approved), plaque cm.99,5x45 - 2 zones de cuisson • **ES FRY-TOP ELÉCTRICO 2/5 ESTRIADO + 3/5 LISO CROMADO SUPERCHROME (MOCA APPROVED), PLANCHA CM.99,5X45 - 2 ZONAS DE COCCIÓN**
cm. 100x 60x 28h

⚡ 11,25 kW **3.888,00**
400V~3N 88 / 0,46
50/60 Hz



FTRT-610ET Fry-top elettrico rigato, piastra cm.99,5x45 - 2 zone di cottura
16061033
EN Electric Fry-top grooved griddle, plate cm.99,5x45 - 2 cooking areas • **DE** Griddleplatte elektrische gerillt, platte cm.99,5x45 - 2 Heizzonen • **FR** Plaque électriques nervurée, plaque cm.99,5x45 - 2 zones de cuisson • **ES FRY-TOP ELÉCTRICO ESTRIADO, PLANCHA CM.99,5X45 - 2 ZONAS DE COCCIÓN**
cm. 100x 60x 28h

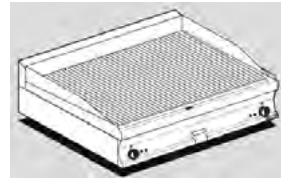

⚡ 11,25 kW **3.494,00**
400V~3N 88 / 0,46
50/60 Hz



FTRT-610ETS Fry-top elettrico rigato cromato SUPERCHROME (Moca Approved), piastra cm.99,5x45 - 2 zone di cottura
16061036
EN Electric Fry-top grooved chromed griddle SUPERCHROME (Moca Approved), plate cm.99,5x45 - 2 cooking areas • **DE** Griddleplatte elektrische gerillt hartverchromt SUPERCHROME (Moca Approved), platte cm.99,5x45 - 2 Heizzonen • **FR** Plaque électriques nervurée chromée SUPERCHROME (Moca Approved), plaque cm.99,5x45 - 2 zones de cuisson • **ES FRY-TOP ELÉCTRICO ESTRIADO CROMADO SUPERCHROME (MOCA APPROVED), PLANCHA CM.99,5X45 - 2 ZONAS DE COCCIÓN**
cm. 100x 60x 28h

⚡ 11,25 kW **4.080,00**
400V~3N 88 / 0,46
50/60 Hz



FTLT-64G Fry-top gas liscio, piastra cm.39,5x45
16230451
EN Gas Fry-top smooth griddle, plate cm.39,5x45 • **DE** Gas-griddleplatte glatt, platte cm.39,5x45 • **FR** Plaque gaz lisse, plaque cm.39,5x45 • **ES FRY-TOP GAS LISO, PLANCHA CM.39,5X45**
cm. 40x 60x 28h



⚡ 6 kW **1.496,00**
5.160 kcal/h 47 / 0,19



FTLT-64GS Fry-top gas liscio cromato SUPERCHROME (Moca Approved), piastra cm.39,5x45
16230454
EN Gas Fry-top smooth chromed griddle SUPERCHROME (Moca Approved), plate cm.39,5x45 • **DE** Gas-griddleplatte glatt hartverchromt SUPERCHROME (Moca Approved), platte cm.39,5x45 • **FR** Plaque gaz lisse chromée SUPERCHROME (Moca Approved), plaque cm.39,5x45 • **ES FRY-TOP GAS LISO CROMADO SUPERCHROME (MOCA APPROVED), PLANCHA CM.39,5X45**
cm. 40x 60x 28h

⚡ 6 kW **1.986,00**
5.160 kcal/h 47 / 0,19



FTLT-64GSS Fry-top gas liscio CROMO LUCIDO, piastra cm.39,5x45
16230450
EN Gas Fry-top smooth POLISHED CHROME, plate cm.39,5x45 • **DE** Gas-griddleplatte glatt POLIERTEM CHROM, platte cm.39,5x45 • **FR** Plaque gaz lisse CHROME POLI, plaque cm.39,5x45 • **ES FRY-TOP GAS LISO CROMO PULIDO, PLANCHA CM.39,5X45**
cm. 40x 60x 28h

⚡ 6 kW **1.986,00**
5.160 kcal/h 47 / 0,19



FRY-TOP A GAS - TOP

MOD. _____ DESCRIZIONE/DESCRIPTION/BEZEICHNUNG/DESCRIPTION/DESCRIPCIÓN POTENZA/POWER/LEISTUNG/PUISSANCE/POTENCIA kW kcal/h V~ Hz PREZZO/PRICE € KG / M³
 COD. _____ DIMENSIONI/DIMENSIONS/ABMESSUNGEN/DIMENSIONS/DIMENSIONES VOLTAGGIO/VOLTAGE/SPANNUNG/VOLTAGE/VOLTAGE

FTRT-64G Fry-top gas rigato, piastra cm.39,5x45
 16230453 **EN** Gas Fry-top grooved griddle, plate cm.39,5x45 • **DE** Gas-griddleplatte gerillt, platte cm.39,5x45 • **FR** Plaque gaz nervurée, plaque cm.39,5x45 • **ES FRY-TOP GAS ESTRIADO, PLANCHA CM.39,5X45**
cm. 40x 60x 28h

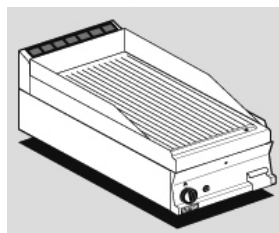

6 kW / 5.160 kcal/h **1.635,00** / 47 / 0,19



FTRT-64GS Fry-top gas rigato cromato SUPERCHROME (Moca Approved), piastra cm.39,5x45
 16230456 **EN** Gas Fry-top grooved chromed griddle SUPERCHROME (Moca Approved), plate cm.39,5x45 • **DE** Gas-griddleplatte gerillt hartverchromt SUPERCHROME (Moca Approved), platte cm.39,5x45 • **FR** Plaque gaz nervurée chromée SUPERCHROME (Moca Approved), plaque cm.39,5x45 • **ES FRY-TOP GAS ESTRIADO CROMADO SUPERCHROME (MOCA APPROVED), PLANCHA CM.39,5X45**
cm. 40x 60x 28h

6 kW / 5.160 kcal/h **2.190,00** / 47 / 0,19



FTLT-66G Fry-top gas liscio, piastra cm.59,5x45 - 2 zone di cottura
 16230651 **EN** Gas Fry-top smooth griddle, plate cm.59,5x45 - 2 cooking areas • **DE** Gas-griddleplatte glatt, platte cm.59,5x45 - 2 Heizzonen • **FR** Plaque gaz lisse, plaque cm.59,5x45 - 2 zones de cuisson • **ES FRY-TOP GAS LISO, PLANCHA CM.59,5X45 - 2 ZONAS DE COCCIÓN**
cm. 60x 60x 28h

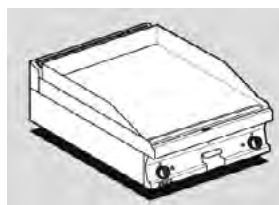

9 kW / 7.740 kcal/h **2.131,00** / 65 / 0,28

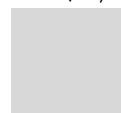

FTLT-66GS Fry-top gas liscio cromato SUPERCHROME (Moca Approved), piastra cm.59,5x45 - 2 zone di cottura
 16230654 **EN** Gas Fry-top smooth chromed griddle SUPERCHROME (Moca Approved), plate cm.59,5x45 - 2 cooking areas • **DE** Gas-griddleplatte glatt hartverchromt SUPERCHROME (Moca Approved), platte cm.59,5x45 - 2 Heizzonen • **FR** Plaque gaz lisse chromée SUPERCHROME (Moca Approved), plaque cm.59,5x45 - 2 zones de cuisson • **ES FRY-TOP GAS LISO CROMADO SUPERCHROME (MOCA APPROVED), PLANCHA CM.59,5X45 - 2 ZONAS DE COCCIÓN**
cm. 60x 60x 28h

9 kW / 7.740 kcal/h **2.565,00** / 65 / 0,28



FTLT-66GSS Fry-top gas liscio CROMO LUCIDO, piastra cm.59,5x45 - 2 zone di cottura
 16230650 **EN** Gas Fry-top smooth POLISHED CHROME, plate cm.59,5x45 - 2 cooking areas • **DE** Gas-griddleplatte glatt POLIERTEM CHROM, platte cm.59,5x45 - 2 Heizzonen • **FR** Plaque gaz lisse CHROME POLI, plaque cm.59,5x45 - 2 zones de cuisson • **ES FRY-TOP GAS LISO CROMO PULIDO, PLANCHA CM.59,5X45 - 2 ZONAS DE COCCIÓN**
cm. 60x 60x 28h

9 kW / 7.740 kcal/h **2.565,00** / 65 / 0,28

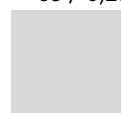

FTLRT-66G Fry-top gas 1/2 rigato + 1/2 liscio, piastra cm.59,5x45 - 2 zone di cottura
 16230652 **EN** Gas Fry-top 1/2 grooved + 1/2 smooth, plate cm.59,5x45 - 2 cooking areas • **DE** Gas-griddleplatte 1/2 gerillt + 1/2 glatt, platte cm.59,5x45 - 2 Heizzonen • **FR** Plaque gaz 1/2 nervurée + 1/2 lisse, plaque cm.59,5x45 - 2 zones de cuisson • **ES FRY-TOP GAS 1/2 ESTRIADO + 1/2 LISO, PLANCHA CM.59,5X45 - 2 ZONAS DE COCCIÓN**
cm. 60x 60x 28h



9 kW / 7.740 kcal/h **2.290,00** / 65 / 0,28

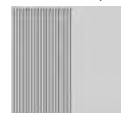

FTLRT-66GS Fry-top gas 1/2 rigato + 1/2 liscio cromato SUPERCHROME (Moca Approved), piastra cm.59,5x45 - 2 zone di cottura
 16230655 **EN** Gas Fry-top 1/2 grooved + 1/2 smooth chromed griddle SUPERCHROME (Moca Approved), plate cm.59,5x45 - 2 cooking areas • **DE** Gas-griddleplatte 1/2 gerillt + 1/2 glatt hartverchromt SUPERCHROME (Moca Approved), platte cm.59,5x45 - 2 Heizzonen • **FR** Plaque gaz 1/2 nervurée + 1/2 lisse chromée SUPERCHROME (Moca Approved), plaque cm.59,5x45 - 2 zones de cuisson • **ES FRY-TOP GAS 1/2 ESTRIADO + 1/2 LISO CROMADO SUPERCHROME (MOCA APPROVED), PLANCHA CM.59,5X45 - 2 ZONAS DE COCCIÓN**
cm. 60x 60x 28h

9 kW / 7.740 kcal/h **2.625,00** / 65 / 0,28

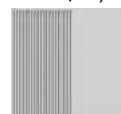

FRY-TOP A GAS - TOP

MOD. _____ DESCRIZIONE/DESCRIPTION/BEZEICHNUNG/DESCRIPTION/DESCRIPCIÓN POTENZA/POWER/LEISTUNG/PUISSANCE/POTENCIA PREZZO/PRICE €
 COD. _____ DIMENSIONI/DIMENSIONS/ABMESSUNGEN/DIMENSIONS/DIMENSIONES VOLTAGGIO/VOLTAGE/SPANNUNG/VOLTAGE/VOLTAJE kcal/h $\frac{kW}{V}$ PREIS/PRIX/PRECIO €
 KG / M³

FTRT-66G
 16230653 Fry-top gas rigato, piastra cm.59,5x45 - 2 zone di cottura
EN Gas Fry-top grooved griddle, plate cm.59,5x45 - 2 cooking areas
 • **DE** Gas-griddleplatte gerillt, platte cm.59,5x45 - 2 Heizzonen • **FR** Plaque gaz nervurée, plaque cm.59,5x45 - 2 zones de cuisson • **ES FRY-TOP GAS ESTRIADO, PLANCHA CM.59,5X45 - 2 ZONAS DE COCCIÓN**
cm. 60x 60x 28h

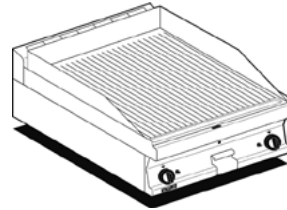

9 kW **2.449,00**
 7.740 kcal/h 65 / 0,28



FTRT-66GS
 16230656 Fry-top gas rigato cromato SUPERCHROME (Moca Approved), piastra cm.59,5x45 - 2 zone di cottura
EN Gas Fry-top grooved chromed griddle SUPERCHROME (Moca Approved), plate cm.59,5x45 - 2 cooking areas • **DE** Gas-griddleplatte gerillt hartverchromt SUPERCHROME (Moca Approved), platte cm.59,5x45 - 2 Heizzonen • **FR** Plaque gaz nervurée chromée SUPERCHROME (Moca Approved), plaque cm.59,5x45 - 2 zones de cuisson • **ES FRY-TOP GAS ESTRIADO CROMADO SUPERCHROME (MOCA APPROVED), PLANCHA CM.59,5X45 - 2 ZONAS DE COCCIÓN**
cm. 60x 60x 28h

9 kW **2.753,00**
 7.740 kcal/h 65 / 0,28

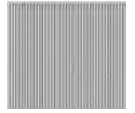

FTLT-68G
 16230851 Fry-top gas liscio, piastra cm.79,5x45 - 2 zone di cottura
EN Gas Fry-top smooth griddle, plate cm.79,5x45 - 2 cooking areas
 • **DE** Gas-griddleplatte glatt, platte cm.79,5x45 - 2 Heizzonen • **FR** Plaque gaz lisse, plaque cm.79,5x45 - 2 zones de cuisson • **ES FRY-TOP GAS LISO, PLANCHA CM.79,5X45 - 2 ZONAS DE COCCIÓN**
cm. 80x 60x 28h

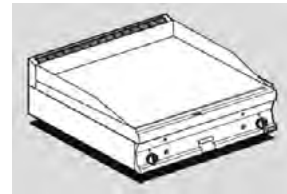

12 kW **2.946,00**
 10.320 kcal/h 83 / 0,37



FTLT-68GS
 16230854 Fry-top gas liscio cromato SUPERCHROME (Moca Approved), piastra cm.79,5x45 - 2 zone di cottura
EN Gas Fry-top smooth chromed griddle SUPERCHROME (Moca Approved), plate cm.79,5x45 - 2 cooking areas • **DE** Gas-griddleplatte glatt hartverchromt SUPERCHROME (Moca Approved), platte cm.79,5x45 - 2 Heizzonen • **FR** Plaque gaz lisse chromée SUPERCHROME (Moca Approved), plaque cm.79,5x45 - 2 zones de cuisson • **ES FRY-TOP GAS LISO CROMADO SUPERCHROME (MOCA APPROVED), PLANCHA CM.79,5X45 - 2 ZONAS DE COCCIÓN**
cm. 80x 60x 28h

12 kW **3.502,00**
 10.320 kcal/h 83 / 0,37

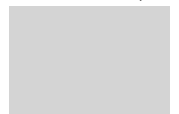

FTLT-68GS5
 16230850 Fry-top gas liscio CROMO LUCIDO, piastra cm.79,5x45 - 2 zone di cottura
EN Gas Fry-top smooth POLISHED CHROME, plate cm.79,5x45 - 2 cooking areas • **DE** Gas-griddleplatte glatt POLIERTEM CHROM, platte cm.79,5x45 - 2 Heizzonen • **FR** Plaque gaz lisse CHROME POLI, plaque cm.79,5x45 - 2 zones de cuisson • **ES FRY-TOP GAS LISO CROMO PULIDO, PLANCHA CM.79,5X45 - 2 ZONAS DE COCCIÓN**
cm. 80x 60x 28h

12 kW **3.502,00**
 10.320 kcal/h 83 / 0,37



FTLRT-68G
 16230852 Fry-top gas 1/2 rigato + 1/2 liscio, piastra cm.79,5x45 - 2 zone di cottura
EN Gas Fry-top 1/2 grooved + 1/2 smooth, plate cm.79,5x45 - 2 cooking areas • **DE** Gas-griddleplatte 1/2 gerillt + 1/2 glatt, platte cm.79,5x45 - 2 Heizzonen • **FR** Plaque gaz 1/2 nervurée + 1/2 lisse, plaque cm.79,5x45 - 2 zones de cuisson • **ES FRY-TOP GAS 1/2 ESTRIADO + 1/2 LISO, PLANCHA CM.79,5X45 - 2 ZONAS DE COCCIÓN**
cm. 80x 60x 28h

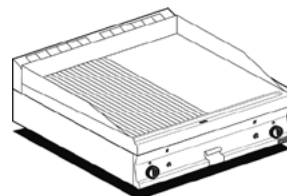

12 kW **3.053,00**
 10.320 kcal/h 83 / 0,37

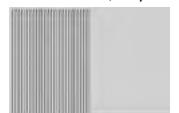

FTLRT-68GS
 16230855 Fry-top gas 1/2 rigato + 1/2 liscio cromato SUPERCHROME (Moca Approved), piastra cm.79,5x45 - 2 zone di cottura
EN Gas Fry-top 1/2 grooved + 1/2 smooth chromed griddle SUPERCHROME (Moca Approved), plate cm.79,5x45 - 2 cooking areas • **DE** Gas-griddleplatte 1/2 gerillt + 1/2 glatt hartverchromt SUPERCHROME (Moca Approved), platte cm.79,5x45 - 2 Heizzonen • **FR** Plaque gaz 1/2 nervurée + 1/2 lisse chromée SUPERCHROME (Moca Approved), plaque cm.79,5x45 - 2 zones de cuisson • **ES FRY-TOP GAS 1/2 ESTRIADO + 1/2 LISO CROMADO SUPERCHROME (MOCA APPROVED), PLANCHA CM.79,5X45 - 2 ZONAS DE COCCIÓN**
cm. 80x 60x 28h

12 kW **3.587,00**
 10.320 kcal/h 83 / 0,37



FRY-TOP A GAS - TOP

MOD. _____ DESCRIZIONE/DESCRIPTION/BEZEICHNUNG/DESCRIPTION/DESCRIPCIÓN POTENZA/POWER/LEISTUNG/PUISSANCE/POTENCIA kW kcal/h $\frac{kW}{kcal/h}$ PREZZO/PRICE € PREIS/PRIX/PRECIO € KG / M³
 COD. _____ DIMENSIONI/DIMENSIONS/ABMESSUNGEN/DIMENSIONS/DIMENSIONES VOLTAGGIO/VOLTAGE/SPANNUNG/VOLTAGE/VOLTAJE V~ Hz

FTRT-68G Fry-top gas rigato, piastra cm.79,5x45 - 2 zone di cottura
 16230853 **EN** Gas Fry-top grooved griddle, plate cm.79,5x45 - 2 cooking areas
 • **DE** Gas-griddleplatte gerillt, platte cm.79,5x45 - 2 Heizzonen • **FR** Plaque gaz nervurée, plaque cm.79,5x45 - 2 zones de cuisson • **ES FRY-TOP GAS ESTRIADO, PLANCHA CM.79,5X45 - 2 ZONAS DE COCCIÓN**
cm. 80x 60x 28h

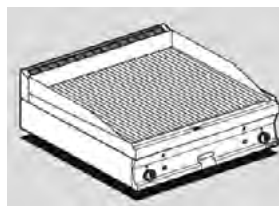

12 kW **3.248,00**
 10.320 kcal/h 83 / 0,37

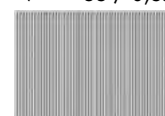

FTRT-68GS Fry-top gas rigato cromato SUPERCHROME (Moca Approved), piastra
 16230856 cm.79,5x45 - 2 zone di cottura
EN Gas Fry-top grooved chromed griddle SUPERCHROME (Moca Approved), plate cm.79,5x45 - 2 cooking areas • **DE** Gas-griddleplatte gerillt hartverchromt SUPERCHROME (Moca Approved), platte cm.79,5x45 - 2 Heizzonen • **FR** Plaque gaz nervurée chromée SUPERCHROME (Moca Approved), plaque cm.79,5x45 - 2 zones de cuisson • **ES FRY-TOP GAS ESTRIADO CROMADO SUPERCHROME (MOCA APPROVED), PLANCHA CM.79,5X45 - 2 ZONAS DE COCCIÓN**
cm. 80x 60x 28h

12 kW **3.779,00**
 10.320 kcal/h 83 / 0,37



FTLT-610G Fry-top gas liscio, piastra cm.99,5x45 - 2 zone di cottura
 16231051 **EN** Gas Fry-top smooth griddle, plate cm.99,5x45 - 2 cooking areas
 • **DE** Gas-griddleplatte glatt, platte cm.99,5x45 - 2 Heizzonen • **FR** Plaque gaz lisse, plaque cm.99,5x45 - 2 zones de cuisson • **ES FRY-TOP GAS LISO, PLANCHA CM.99,5X45 - 2 ZONAS DE COCCIÓN**
cm. 100x 60x 28h

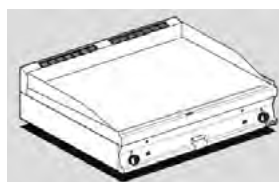

15 kW **3.372,00**
 12.900 kcal/h 89 / 0,46



FTLT-610GS Fry-top gas liscio cromato SUPERCHROME (Moca Approved), piastra
 16231054 cm.99,5x45 - 2 zone di cottura
EN Gas Fry-top smooth chromed griddle SUPERCHROME (Moca Approved), plate cm.99,5x45 - 2 cooking areas • **DE** Gas-griddleplatte glatt hartverchromt SUPERCHROME (Moca Approved), platte cm.99,5x45 - 2 Heizzonen • **FR** Plaque gaz lisse chromée SUPERCHROME (Moca Approved), plaque cm.99,5x45 - 2 zones de cuisson • **ES FRY-TOP GAS LISO CROMADO SUPERCHROME (MOCA APPROVED), PLANCHA CM.99,5X45 - 2 ZONAS DE COCCIÓN**
cm. 100x 60x 28h

15 kW **3.931,00**
 12.900 kcal/h 89 / 0,46



FTLT-610GSS Fry-top gas liscio CROMO LUCIDO, piastra cm.99,5x45 - 2 zone di
 16231050 cottura
EN Gas Fry-top smooth POLISHED CHROME, plate cm.99,5x45 - 2 cooking areas • **DE** Gas-griddleplatte glatt POLIERTEM CHROM, platte cm.99,5x45 - 2 Heizzonen • **FR** Plaque gaz lisse CHROME POLI, plaque cm.99,5x45 - 2 zones de cuisson • **ES FRY-TOP GAS LISO CROMO PULIDO, PLANCHA CM.99,5X45 - 2 ZONAS DE COCCIÓN**
cm. 100x 60x 28h

15 kW **3.931,00**
 12.900 kcal/h 89 / 0,46



FTLRT-610G Fry-top gas 2/5 rigato + 3/5 liscio, piastra cm.99,5x45 - 2 zone di
 16231052 cottura
EN Gas Fry-top 2/5 grooved + 3/5 smooth, plate cm.99,5x45 - 2 cooking areas • **DE** Gas-griddleplatte 2/5 gerillt + 3/5 glatt, platte cm.99,5x45 - 2 Heizzonen • **FR** Plaque gaz 2/5 nervurée + 3/5 lisse, plaque cm.99,5x45 - 2 zones de cuisson • **ES FRY-TOP GAS 2/5 ESTRIADO + 3/5 LISO, PLANCHA CM.99,5X45 - 2 ZONAS DE COCCIÓN**
cm. 100x 60x 28h



15 kW **3.554,00**
 12.900 kcal/h 89 / 0,46



FTLRT-610GS Fry-top gas 2/5 rigato + 3/5 liscio cromato SUPERCHROME (Moca
 16231055 Approved), piastra cm.99,5x45 - 2 zone di cottura
EN Gas Fry-top 2/5 grooved + 3/5 smooth chromed griddle SUPERCHROME (Moca Approved), plate cm.99,5x45 - 2 cooking areas • **DE** Gas-griddleplatte 2/5 gerillt + 3/5 glatt hartverchromt SUPERCHROME (Moca Approved), platte cm.99,5x45 - 2 Heizzonen • **FR** Plaque gaz 2/5 nervurée + 3/5 lisse chromée SUPERCHROME (Moca Approved), plaque cm.99,5x45 - 2 zones de cuisson • **ES FRY-TOP GAS 2/5 ESTRIADO + 3/5 LISO CROMADO SUPERCHROME (MOCA APPROVED), PLANCHA CM.99,5X45 - 2 ZONAS DE COCCIÓN**
cm. 100x 60x 28h

15 kW **4.102,00**
 12.900 kcal/h 89 / 0,46



PIANI COTTURA ELETTRICI - TOP

MOD. _____
COD. _____

DESCRIZIONE/DESCRIPTION/BEZEICHNUNG/DESCRIPTION/DESCRIPCIÓN
DIMENSIONI/DIMENSIONS/ABMESSUNGEN/DIMENSIONS/DIMENSIONES

POTENZA/POWER/LEISTUNG/PUISSANCE/POTENCIA
VOLTAGGIO/VOLTAGE/SPANNUNG/VOLTAGE/VOLTAGE

⚡ kW _____
kcal/h _____
V~ _____
Hz _____

PREZZO/PRICE €
PREIS/PRIX/PRECIO €
KG / M²

FTRT-610G Fry-top gas rigato, piastra cm.99,5x45 - 2 zone di cottura
16231053 **EN** Gas Fry-top grooved griddle, plate cm.99,5x45 - 2 cooking areas
• **DE** Gas-griddleplatte gerillt, platte cm.99,5x45 - 2 Heizzonen • **FR**
Plaque gaz nervurée, plaque cm.99,5x45 - 2 zones de cuisson • **ES**
FRY-TOP GAS ESTRIADO, PLANCHA CM.99,5X45 - 2 ZONAS DE COCCIÓN
cm. 100x 60x 28h

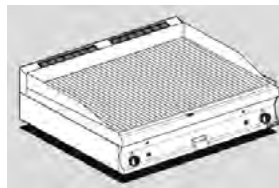

⚡ 15 kW _____ **3.882,00**
12.900 kcal/h _____ 89 / 0,46



FTRT-610GS Fry-top gas rigato cromato SUPERCHROME (Moca Approved), piastra
16231056 cm.99,5x45 - 2 zone di cottura
EN Gas Fry-top grooved chromed griddle SUPERCHROME (Moca
Approved), plate cm.99,5x45 - 2 cooking areas • **DE** Gas-
griddleplatte gerillt hartverchromt SUPERCHROME (Moca Approved),
platte cm.99,5x45 - 2 Heizzonen • **FR** Plaque gaz nervurée chromée
SUPERCHROME (Moca Approved), plaque cm.99,5x45 - 2 zones
de cuisson • **ES FRY-TOP GAS ESTRIADO CROMADO**
SUPERCHROME (MOCA APPROVED), PLANCHA
CM.99,5X45 - 2 ZONAS DE COCCIÓN
cm. 100x 60x 28h

⚡ 15 kW _____ **4.274,00**
12.900 kcal/h _____ 89 / 0,46



RSFT-63EM Piastra per sandwich sopra frytop elettrici - Piastra cm. 29x40
16630317 (ATTENZIONE: PROFONDITA' MACCHINA +cm.10)
EN Sandwiches plate above electric griddle - plate cm. 29x40
(ATTENTION: DEPTH MACHINE +cm.10) • **DE** Sandwiches Platte über
Elektrische Griddle - platte cm. 29x40 (VORSICHT: TIEFE MACHINE
+cm.10) • **FR** Plaque pour sandwich au-dessus électrique fry-
top - plaque cm. 29x40 (ATTENTION: PROFONDEUR MACHINE
+cm.10) • **ES PLANCIA PARA SÁNDWICHES SOBRE FRY-
TOP ELÉCTRICO - PLANCHA CM. 29X40 (ATENCIÓN:
PROFUNDIDAD MÁQUINA +CM.10)**
cm. 32x 61x 41h



⚡ 2,9 kW _____ **1.435,00**
230V~ _____ 20 / 0,21
50/60 Hz

PCT-63ET PIANO COTTURA TRIFASE N. 2 piastre
16030330 **EN** Boiling unit - N. 2 plates • **DE** Kochplatte - N. 2 Kochplatten
• **FR** Rechaud - N. 2 plaques • **ES SOBRE DE COCCIÓN - N. 2**
PLANCHAS
cm. 30x 60x 28h

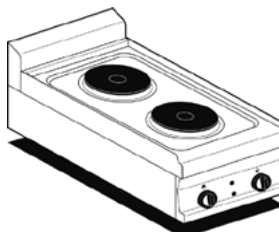

⚡ 3 kW _____ **865,00**
400V~2N _____ 16 / 0,15
230V~3
230V~
50/60 Hz

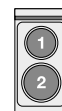

PCT-66ET PIANO COTTURA TRIFASE N. 4 piastre
16030630 **EN** Boiling unit - N. 4 plates • **DE** Kochplatte - N. 4 Kochplatten
• **FR** Rechaud - N. 4 plaques • **ES SOBRE DE COCCIÓN - N. 4**
PLANCHAS
cm. 60x 60x 28h



⚡ 6 kW _____ **1.392,00**
400V~3N _____ 27 / 0,28
230V~3
230V~
50/60 Hz

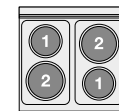

PCCT-63ET PIANO COTTURA VETROCERAMICA TRIFASE - N. 2 zone - vetro
16030332 cm.25x47
EN Ceramic glass boiling unit - n. 2 zones - glass cm.25x47 • **DE**
Ceran-Kochplatte dreiphasig - 2 zonen - Glas 25x47 cm • **FR** Plan
de cuisson à vitrocéramique triphasé N. 2 zones - Verre cm.25x47
• **ES SOBRE DE COCCIÓN TRIFÁSICO VITROCERÁMICA - 2**
ZONAS - VIDRO CM.35X57
cm. 30x 60x 28h



⚡ 3 kW _____ **1.929,00**
400V~2N _____ 19 / 0,15
230V~3
230V~
50/60 Hz

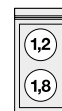

PIANI COTTURA A INDUZIONE - TOP

MOD. _____
COD. _____

DESCRIZIONE/DESCRIPTION/BEZEICHNUNG/DESCRIPTION/DESCRIPCIÓN
DIMENSIONI/DIMENSIONS/ABMESSUNGEN/DIMENSIONS/DIMENSIONES

POTENZA/POWER/LEISTUNG/PUISSANCE/POTENCIA
VOLTAGGIO/VOLTAGE/SPANNUNG/VOLTAGE/VOLTAGE

⚡ $\frac{\text{kW}}{\text{kcal/h}}$ $\frac{\text{kW}}{\text{V} \sim \text{Hz}}$

PREZZO/PRICE €
KG / M³

PCCT-66ET
16030632

PIANO COTTURA VETRO CERAMICA TRIFASE - N. 4 zone - vetro cm.55x47
EN Ceramic glass boiling unit - n. 4 zones - glass cm.55x47 • **DE** Ceran-Kochplatte dreiphasig - 4 zonen - Glas 55x47 cm • **FR** Plan de cuisson à vitroceramique triphasé N. 4 zones - Verre cm.55x47
• **ES SOBRE DE COCCIÓN TRIFÁSICO VITROCERÁMICA - 2 ZONAS - VIDRO CM.35X57**
cm. 60x 60x 28h



⚡ $\frac{6 \text{ kW}}{400\text{V} \sim 3\text{N}}$ **3.291,00**
 $\frac{230\text{V} \sim 3}{230\text{V} \sim}$ 26 / 0,28
 $\frac{50/60 \text{ Hz}}$

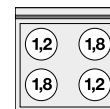

PCIT-64ET
16030433

PIANI COTTURA A INDUZIONE TRIFASE - Vetro cm 35x47 (non posizionare su forni o cassettiere)
EN Three-phase induction cooking top - Plates cm 35x47 (do not place on ovens or drawers) • **DE** Induktions-Kochplatte dreiphasig cm 35x47 (nicht Platz auf Öfen oder Schubladen) • **FR** Plan de cuisson à induction triphasé - Verre cm. 35x47 (ne placez pas sur des fours ou des tiroirs) • **ES ENCIMERA INDUCCIÓN TRIFÁSICA - VIDRIO CM. 35X47 (NO COLOQUE EN LOS HORNOS O EN LOS CAJONES)**
cm. 40x 60x 28h



⚡ $\frac{5 \text{ kW}}{400\text{V} \sim 3}$ **5.372,00**
 $\frac{50/60 \text{ Hz}}$ 23 / 0,19

PCIWT-64ET
16030434

PIANI COTTURA A INDUZIONE WOK 1 piastra induzione - Vetro Ø 30 cm (non posizionare su forni o cassettiere)
EN Three-phase wok induction cooking top 1 glass induction plates Ø 30 cm (do not place on ovens or drawers) • **DE** Induktions-Kochplatte dreiphasig Wok 1 Glasinduktionsplatten Ø 30 cm (nicht Platz auf Öfen oder Schubladen) • **FR** Plan de cuisson à induction triphasé wok 1 plaques à induction - Verre Ø 30 cm (ne placez pas sur des fours ou des tiroirs) • **ES ENCIMERA INDUCCIÓN TRIFÁSICA WOK 1 PLACAS INDUCCIÓN - VIDRIO Ø 30 CM (NO COLOQUE EN LOS HORNOS O EN LOS CAJONES)**
cm. 40x 60x 28h



⚡ $\frac{5 \text{ kW}}{400\text{V} \sim 3}$ **5.566,00**
 $\frac{50/60 \text{ Hz}}$ 23 / 0,19

PCT-63G
16210350

PIANO COTTURA A GAS, 2 FUOCHI
EN Gas heated boiling - 2 burners • **DE** Gas-Kochplatte - 2 Kochstellen
• **FR** Rechaud gaz - 2 feux vifs • **ES SOBRES DE COCCIÓN GAS - 2 QUEMADORES**
cm. 30x 60x 28h



⚡ $\frac{9 \text{ kW}}{7.740 \text{ kcal/h}}$ **1.237,00**
20 / 0,15

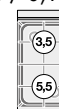

PIANI COTTURA A GAS - TOP

MOD. _____
COD. _____

DESCRIZIONE/DESCRIPTION/BEZEICHNUNG/DESCRIPTION/DESCRIPCIÓN
DIMENSIONI/DIMENSIONS/ABMESSUNGEN/DIMENSIONS/DIMENSIONES

POTENZA/POWER/LEISTUNG/PUISSANCE/POTENCIA
VOLTAGGIO/VOLTAGE/SPANNUNG/VOLTAGE/VOLTAJE

kw kcal/h
V- Hz

PREZZO/PRICE €
PREIS/PRIX/PRECIO
KG / M³

PCT-66G
16210650

PIANO COTTURA A GAS, 4 FUOCHI
EN Gas heated boiling - 4 burners • **DE** Gas-Kochplatte - 4 Kochstellen
• **FR** Rechaud gaz - 4 feux vifs • **ES SOBRES DE COCCIÓN GAS - 4 QUEMADORES**
cm. 60x 60x 28h



18 kW
15.480 kcal/h

1.944,00
31 / 0,28

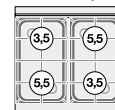

PCT-610G
16211050

PIANO COTTURA A GAS, 6 FUOCHI
EN Gas heated boiling - 6 burners • **DE** Gas-Kochplatte - 6 Kochstellen
• **FR** Rechaud gaz - 6 feux vifs • **ES SOBRES DE COCCIÓN GAS - 6 QUEMADORES**
cm. 100x 60x 28h



27 kW
23.220 kcal/h

3.129,00
63 / 0,46

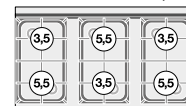

PC1T-64G
16210451

PIANO COTTURA A GAS, 1 FUOCO
EN Gas heated boiling - 1 burner • **DE** Gas-Kochplatte - 1 Kochstellen
• **FR** Rechaud gaz - 1 feux vifs • **ES SOBRES DE COCCIÓN GAS - 1 QUEMADOR**
cm. 40x 60x 28h



10 kW
8.600 kcal/h

1.197,00
23 / 0,19



PC2T-68G
16210851

PIANO COTTURA A GAS, 2 FUOCHI
EN Gas heated boiling - 2 burners • **DE** Gas-Kochplatte - 2 Kochstellen
• **FR** Rechaud gaz - 2 feux vifs • **ES SOBRES DE COCCIÓN GAS - 2 QUEMADORES**
cm. 80x 60x 28h



17 kW
14.620 kcal/h

1.889,00
39 / 0,37

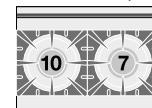

PC3T-612G
16211251

PIANO COTTURA A GAS, 3 FUOCHI
EN Gas heated boiling - 3 burners • **DE** Gas-Kochplatte - 3 Kochstellen
• **FR** Rechaud gaz - 3 feux vifs • **ES SOBRES DE COCCIÓN GAS - 3 QUEMADORES**
cm. 120x 60x 28h



27 kW
23.220 kcal/h

2.764,00
54 / 0,55

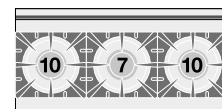

TPT-64G
16290450

TUTTAPIASTRA A GAS Piastra cm 37x50
EN Solid top - Plate cm 37x50 • **DE** Kochplatte - Platte cm 37x50
• **FR** Toute plaque - Plaque cm 37x50 • **ES PLACA DE COCCIÓN - PLACA CM 37X50**
cm. 40x 60x 28h



5,5 kW
4.730 kcal/h

2.050,00
54 / 0,19

TP4T-610G
16301050

TUTTA PIASTRA + 4 FUOCHI Piastra cm. 37x50
EN Solid top + 4 burners - Plate 37x50cm • **DE** Kochplatte + 4 Gaskochstellen - Platte 37x50 cm • **FR** Toute plaque + 4 brûleurs - Plaque cm. 37x50 • **ES PLACA DE COCCIÓN + 4 FUEGOS - PLACA CM. 37X50**
cm. 100x 60x 28h



23,5 kW
20.210 kcal/h

4.377,00
103 / 0,46

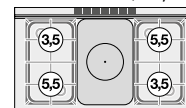

PIANI LAVORO - TOP

MOD. _____ DESCRIZIONE/DESCRIPTION/BEZEICHNUNG/DESCRIPTION/DESCRIPCIÓN POTENZA/POWER/LEISTUNG/PUISSANCE/POTENCIA kW kcal/h PREZZO/PRICE €
 COD. _____ DIMENSIONI/DIMENSIONS/ABMESSUNGEN/DIMENSIONS/DIMENSIONES VOLTAGGIO/VOLTAGE/SPANNUNG/VOLTAGE/VOLTAGE V~ Hz PREIS/PRIX/PRECIO €
 KG / M³

PLT-62 PIANO DI LAVORO **476,00**
 16010200 **EN** Worktop • **DE** Arbeitsplatte • **FR** Plan de travail • **ES SOBRE DE TRABAJO** 13 / 0,15
cm. 20x 60x 28h

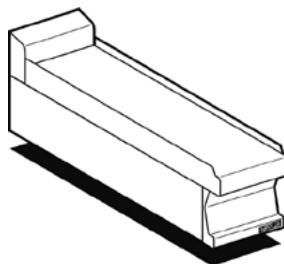

PLT-63 PIANO DI LAVORO con cassetto inox cm.21x47x15h inox **609,00**
 16010300 **EN** Worktop with inox drawer cm.21x47x15h inox • **DE** Arbeitsplatte mit Schublade inox cm.21x47x15h inox • **FR** Plan de travail avec tiroir inox cm.21x47x15h inox • **ES SOBRE DE TRABAJO CON CAJÓN INOX CM.21X47X15H INOX** 21 / 0,15
cm. 30x 60x 28h



PLT-64 PIANO DI LAVORO con cassetto inox cm.31x47x15h inox **642,00**
 16010400 **EN** Worktop with inox drawer cm.31x47x15h inox • **DE** Arbeitsplatte mit Schublade inox cm.31x47x15h inox • **FR** Plan de travail avec tiroir inox cm.31x47x15h inox • **ES SOBRE DE TRABAJO CON CAJÓN INOX CM.31X47X15H INOX** 22 / 0,19
cm. 40x 60x 28h



PLT-66 PIANO DI LAVORO con cassetto inox cm.51x47x15h inox **915,00**
 16010600 **EN** Worktop with inox drawer cm.51x47x15h inox • **DE** Arbeitsplatte mit Schublade inox cm.51x47x15h inox • **FR** Plan de travail avec tiroir inox cm.51x47x15h inox • **ES SOBRE DE TRABAJO CON CAJÓN INOX CM.51X47X15H INOX** 25 / 0,28
cm. 60x 60x 28h



PLT-68 PIANO DI LAVORO con cassetto inox cm.71x47x15h inox **1.120,00**
 16010800 **EN** Worktop with inox drawer cm.71x47x15h inox • **DE** Arbeitsplatte mit Schublade inox cm.71x47x15h inox • **FR** Plan de travail avec tiroir inox cm.71x47x15h inox • **ES SOBRE DE TRABAJO CON CAJÓN INOX CM.71X47X15H INOX** 38 / 0,37
cm. 80x 60x 28h

PLT-610 PIANO DI LAVORO con 2 cassettei inox, 1xcm.51x47x15h + **1.554,00**
 16011000 1xcm.31x47x15h **EN** Worktop with 2 inox drawers, 1xcm.51x47x15h + 1xcm.31x47x15h • **DE** Arbeitsplatte mit 2 Schublade inox, 1xcm.51x47x15h + 1xcm.31x47x15h • **FR** Plan de travail avec 2 tiroirs inox, 1xcm.51x47x15h + 1xcm.31x47x15h • **ES SOBRE DE TRABAJO CON 2 CAJONES INOX, 1XCM.51X47X15H + 1XCM.31X47X15H** 51 / 0,46
cm. 100x 60x 28h

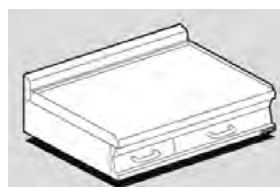

PLA-68 PIANO DI LAVORO AD ANGOLO SU MOBILE **1.854,00**
 06010801 **EN** Corner base with door • **DE** Eckschrank mit Tür • **FR** Placard d'angle avec porte • **ES BASE ANGULAR CON PUERTA** 50 / 0,89
cm.80÷80x 60x 90h



LAVELLI - TOP

MOD. COD.	DESCRIZIONE/DESCRIPTION/BEZEICHNUNG/DESCRIPTION/DESCRIPCIÓN DIMENSIONI/DIMENSIONS/ABMESSUNGEN/DIMENSIONS/DIMENSIONES	POTENZA/POWER/LEISTUNG/PUISSANCE/POTENCIA VOLTAGGIO/VOLTAGE/SPANNUNG/VOLTAGE/VOLTAJE	⚡ kW kcal/h	⚡ kW V~ Hz	PREZZO/PRICE PREIS/PRIX/PRECIO € KG / M³
LAT-64 16020400	LAVELLO 1 VASCA Rubinetto a leva - vasca cm 29x35x14h EN Sink unit - Lever type tap - Bowl cm 29x35x14h • DE Spülbecken - Einhebel-Mischbatterie Becken cm 29x35x14h • FR Bac-évier avec robinetterie - Bac cm 29x35x14h • ES FREGADERO - GRIFO A PALANCA - PILETA CM 29X35X14H cm. 40x 60x 28h				1.044,00 20 / 0,19
LAT-68 16020800	LAVELLO 2 VASCHE cm 29x35x14h Rubinetto a leva EN Sink unit - Lever type tap - 2 Bowls cm 29x35x14h • DE Spülbecken - Einhebel-Mischbatterie 2 Becken cm 29x35x14h • FR Bac-évier avec robinetterie - 2 Bac cm 29x35x14h • ES FREGADERO - GRIFO A PALANCA - 2 PILETA CM 29X35X14H cm. 80x 60x 28h				1.588,00 32 / 0,37
LAT-610DX 16021000	LAVELLO PREDISPOSTO - Vasca cm 29x35x14h Dx Sgocciolatoio cm 60 Sx - Rubinetto a leva a norme. EN Sink unit - R/h Bowl cm 29x35x14h - L/h Draining board cm 60 Suitable for dishwasher - Lever type tap. • DE Spülbecken - Becken cm 29x35x14h rechts Abtropffläche cm 60 links - Vorbereitung für Geschirrspülmaschine - Einhebel-Mischbatterie • FR Plan évier - Bac à droite cm 29x35x14h Égouttoir à gauche cm 60 Prêdisposé pour lave-vaisselle Robinetterie • ES FREGADERO PREDISPUERTO - PILETA CM 29X35X14H DERECHO ESCURRIDOR 60 CM IZQ. - GRIFO A PALANCA SEGÚN NORMATIVA cm. 100x 60x 28h				1.437,00 36 / 0,46
LAT-610SX 16021001	LAVELLO PREDISPOSTO - Vasca cm 29x35x14h Sx Sgocciolatoio cm 60 Dx - Rubinetto a leva a norme. EN Sink unit - L/h Bowl cm 29x35x14h - R/h Draining board cm 60 Suitable for dishwasher - Lever type tap. • DE Spülbecken - Becken cm 29x35x14h links Abtropffläche cm 60 rechts - Vorbereitung für Geschirrspülmaschine - Einhebel-Mischbatterie • FR Plan évier - Bac à gauche cm 29x35x14h Égouttoir à droite cm 60 Prêdisposé pour lave-vaisselle Robinetterie • ES FREGADERO PREDISPUERTO - PILETA CM 29X35X14H IZQ. ESCURRIDOR 60 CM DERECHO - GRIFO A PALANCA SEGÚN NORMATIVA cm. 100x 60x 28h				1.437,00 36 / 0,46
LAA-68 06020801	LAVELLO AD ANGOLO SU MOBILE Vasca cm 50x40x20h EN Corner base with sink and door Bowl cm 50x40x20h • DE Eckschrank mit Spülbecken und mit Tür Becken cm 50x40x20h • FR Placard d'angle avec porte et évier Cuve cm 50x40x20h • ES CON FREGADERO Y PUERTA CM. CUBA CM 50X40X20H cm.80÷80x 60x 90h				2.143,00 50 / 0,89
MFM-68EM 06490812	BASE CON Forno elettrico multifunzione cm. 46x37x35h, temp: 50÷250°C, con 1 griglia cm.41x32,5 - porta vetro (non sovrapporre elementi ad induzione) EN Stand with Multifunction electric oven cm. 46x37x35h, temp: 50÷250°C, with 1 grid cm.41x32,5 - Glass door (no induction top) • DE unterbau mit Multifunktions-Elektroofen cm. 46x37x35h, temp: 50÷250°C, mit 1 Rost cm.41x32,5 - Glastür (nicht Induktions) • FR placard avec Four électrique à fonctions multiples cm. 46x37x35h, temp: 50÷250°C, avec 1 grille cm.41x32,5 - Porte vitrée (il faut pas de induction) • ES MUEBLE CON HORNO ELÉCTRICO MULTIFUNCIONAL CM. 46X37X35H, TEMP: 50÷250°C, CON 1 PARILLA CM.41X32,5 - PUERTA VIDRIO (NO INDUCCIÓN) cm. 80x 57,5x 57h		⚡ 3,05 kW	230V~ 50/60 Hz	2.952,00 51 / 0,43

BASE CON FORNO ELETTRICO

MOD. _____ DESCRIZIONE/DESCRIPTION/BEZEICHNUNG/DESCRIPTION/DESCRIPCIÓN POTENZA/POWER/LEISTUNG/PUISSANCE/POTENCIA $\frac{\text{kW}}{\text{kcal/h}}$ $\frac{\text{kW}}{\text{V~}}$ PREZZO/PRICE €
 COD. _____ DIMENSIONI/DIMENSIONS/ABMESSUNGEN/DIMENSIONS/DIMENSIONES VOLTAGGIO/VOLTAGE/SPANNUNG/VOLTAGE/VOLTAJE Hz PREIS/PRIX/PRECIO €
 KG / M³

MFM-68EM BASE CON Forno elettrico multifunzione cm. 46x37x35h, temp: 50÷250°C, con 1 griglia cm.41x32,5 - Porta cieca inox (non sovrapporre elementi ad induzione)
EN Stand with Multifunction electric oven cm. 46x37x35h, temp: 50÷250°C, with 1 grid cm.41x32,5 - Stainless steel door (no induction top) • **DE** unterbau mit Multifunktions-Elektroofen cm. 46x37x35h, temp: 50÷250°C, mit 1 Rost cm.41x32,5 - Edelstahltür (nicht Induktions) • **FR** placard avec Four électrique à fonctions multiples cm. 46x37x35h, temp: 50÷250°C, avec 1 grille cm.41x32,5 - Porte acier inoxydable (il faut pas de induction) • **ES MUEBLE CON HORNO ELÉCTRICO MULTIFUNCIONAL CM. 46X37X35H, TEMP: 50÷250 °C, CON 1 PARILLA CM.41X32,5 - PUERTA CIEGA INOX (NO INDUCCIÓN)**
cm. 80x 57,5x 57h



3,05 Kw **2.952,00**
 230V~ 51 / 0,43
 50/60 Hz

MFM-610EM BASE CON Forno elettrico multifunzione cm. 64x37x35h, temp: 50÷250°C, con 1 griglia cm.53x32,5 GN1/1 - porta vetro (non sovrapporre elementi ad induzione)
EN Stand with Multifunction electric oven cm. 64x37x35h, temp: 50÷250°C, with 1 grid cm.53x32,5 GN1/1 - Glass door (no induction top) • **DE** unterbau mit Multifunktions-Elektroofen cm. 64x37x35h, temp: 50÷250°C, mit 1 Rost cm.53x32,5 GN1/1 - Glastür (nicht Induktions) • **FR** placard avec Four électrique à fonctions multiples cm. 64x37x35h, temp: 50÷250°C, avec 1 grille cm.53x32,5 GN1/1 - Porte vitrée (il faut pas de induction) • **ES MUEBLE CON HORNO ELÉCTRICO MULTIFUNCIONAL CM. 64X37X35H, TEMP: 50÷250 °C, CON 1 PARILLA CM.53X32,5 GN1/1 - PUERTA VIDRIO (NO INDUCCIÓN)**
cm. 100x 57,5x 57h



3,05 kW **3.259,00**
 230V~ 59 / 0,53
 50/60 Hz

MFM-610EM BASE CON Forno elettrico multifunzione cm. 64x37x35h, temp: 50÷250°C, con 1 griglia cm.53x32,5 GN1/1 - Porta cieca inox (non sovrapporre elementi ad induzione)
EN Stand with Multifunction electric oven cm. 64x37x35h, temp: 50÷250°C, with 1 grid cm.53x32,5 GN1/1 - Stainless steel door (no induction top) • **DE** unterbau mit Multifunktions-Elektroofen cm. 64x37x35h, temp: 50÷250°C, mit 1 Rost cm.53x32,5 GN1/1 - Edelstahltür (nicht Induktions) • **FR** placard avec Four électrique à fonctions multiples cm. 64x37x35h, temp: 50÷250°C, avec 1 grille cm.53x32,5 GN1/1 - Porte acier inoxydable (il faut pas de induction) • **ES MUEBLE CON HORNO ELÉCTRICO MULTIFUNCIONAL CM. 64X37X35H, TEMP: 50÷250 °C, CON 1 PARILLA CM.53X32,5 GN1/1 - PUERTA CIEGA INOX (NO INDUCCIÓN)**
cm. 100x 57,5x 57h



3,05 kW **3.259,00**
 230V~ 59 / 0,53
 50/60 Hz

CMF-68 COPERCHIO per MFM-68E
EN Lid for MFM-68E • **DE** Berichterstattung für MFM-68E • **FR** Couvercle pour MFM-68E • **ES CUBERTURA PARA MFM-68E**
cm. 80x 54x 2,8h



224,00
 4 / 0,02

CMF-610 COPERCHIO per MFM-610E
EN Lid for MFM-610E • **DE** Berichterstattung für MFM-610E • **FR** Couvercle pour MFM-610E • **ES CUBERTURA PARA MFM-610E**
cm. 100x 54x 2,8h

287,00
 5 / 0,03

MPI-64 BASE CON PORTA PER INDUZIONE
EN Stand with door for induction top • **DE** Unterbau für Induktions mit Tür • **FR** Placard pour induction avec porte • **ES MUEBLE BASE PARA INDUCCIÓN CON PUERTA**
cm. 40x 51x 57h



678,00
 18,5 / 0,19

MOBILI BASE

MOD. _____ DESCRIZIONE/DESCRIPTION/BEZEICHNUNG/DESCRIPTION/DESCRIPCIÓN POTENZA/POWER/LEISTUNG/PUISSANCE/POTENCIA ⚡kW ⚡kw PREZZO/PRICE €
 COD. _____ DIMENSIONI/DIMENSIONS/ABMESSUNGEN/DIMENSIONS/DIMENSIONES VOLTAGGIO/VOLTAGE/SPANNUNG/VOLTAGE/VOLTAJE kcal/h V~ Hz PREIS/PRIX/PRECIO €
 KG / M³

M-62 BASE NEUTRA **389,00**
 06410200 **EN** Stand • **DE** Unterbau • **FR** Placard • **ES MUEBLE BASE** 11 / 0,15
 cm. **20x 48,5x 57h**



M-63 BASE NEUTRA a giorno **378,00**
 06410300 **EN** Open Stand • **DE** Offener Unterbau • **FR** Placard ouvert • **ES MUEBLE BASE ABIERTO** 13 / 0,15
 cm. **30x 48,5x 57h**



M-64 cm. **40x 48,5x 57h** **423,00**
 06410400 15 / 0,19



M-66 cm. **60x 48,5x 57h** **469,00**
 06410600 19 / 0,28



M-67 cm. **70x 48,5x 57h** **514,00**
 06410700 20 / 0,37



M-68 cm. **80x 48,5x 57h** **549,00**
 06410800 22 / 0,37



M-69 cm. **90x 48,5x 57h** **685,00**
 06410900 25 / 0,53



M-610 cm. **100x 48,5x 57h** **716,00**
 06411000 27 / 0,53



M-612 cm. **120x 48,5x 57h** **765,00**
 06411200 32 / 0,55



S-63 CAVALLETTO BASE **440,00**
 06400300 **EN** Stand • **DE** Untergestell • **FR** Piedement simple • **ES SOPORTE BASE** 18 / 0,15
 cm. **30x 48,5x 57h**



S-64 cm. **40x 48,5x 57h** **461,00**
 06400400 19 / 0,19



S-66 cm. **60x 48,5x 57h** **476,00**
 06400600 23 / 0,28



S-68 cm. **80x 48,5x 57h** **589,00**
 06400800 26 / 0,37



S-610 cm. **100x 48,5x 57h** **642,00**
 06401000 29 / 0,46



ACCESSORI

MOD. _____ DESCRIZIONE/DESCRIPTION/BEZEICHNUNG/DESCRIPTION/DESCRIPCIÓN POTENZA/POWER/LEISTUNG/PUISSANCE/POTENCIA kW kcal/h PREZZO/PRICE €
 COD. _____ DIMENSIONI/DIMENSIONS/ABMESSUNGEN/DIMENSIONS/DIMENSIONES VOLTAGGIO/VOLTAGE/SPANNUNG/VOLTAGE/VOLTAGE V~ Hz PREIS/PRIX/PRECIO €
 KG / M³

PM-63/73/93-DX PORTA 300 DESTRA
 08430302 **EN** Right door 300 • **DE** Rechte tür 300 • **FR** Porte droite 300 • **ES**
PUERTA DERECHA 300
 cm. 29,5x 2,5x 47,5h



213,00
 3 / 0,01

PM-64/74/94-DX PORTA 400 DESTRA
 08430402 **EN** Right door 400 • **DE** Rechte tür 400 • **FR** Porte droite 400 • **ES**
PUERTA DERECHA 400
 cm. 39,5x 2,5x 47,5h



220,00
 3.5 / 0,02

PM-63/73/93-SX PORTA 300 SINISTRA
 08430303 **EN** Left door 300 • **DE** Linke tür 300 • **FR** Porte gauche 300 • **ES**
PUERTA IZQUIERDA 300
 cm. 29,5x 2,5x 47,5h



213,00
 3 / 0,01

PM-64/74/94-SX PORTA 400 SINISTRA
 08430403 **EN** Left door 400 • **DE** Linke tür 400 • **FR** Porte gauche 400 • **ES**
PUERTA IZQUIERDA 400
 cm. 39,5x 2,5x 47,5h

220,00
 3.5 / 0,02

M-610 =PM-64SX+PM-63SX+PM-63DX

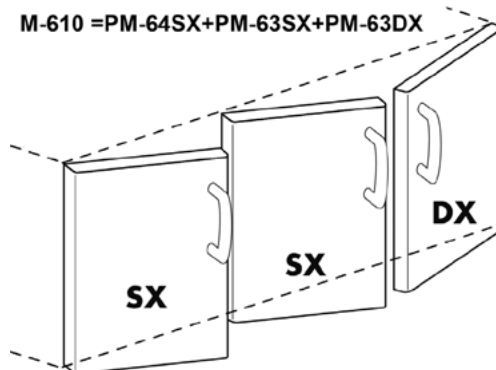

C-63 CASSETTIERA 300/400/600 - N. 2 cassetti con vasca inox Guide
 06440320 telescopiche
EN Drawer set 300/400/600 - N. 2 drawers with inox pans, telescopic
 guides • **DE** Schubladen 300/400/600 - N. 2 Schubladen mit
 chromnickelstahl Telescopeinführungen • **FR** Tiroirs pour meuble de
 300/400/600 - N. 2 tiroirs avec cuve inox, Guides télescopiques • **ES**
CAJONERA 300/400/600 - N. 2 CAJONES CON CUBA DE
ACERO INOX, GUÍAS TELESCÓPICAS
 cm. 29,5x 51x 47,5h



742,00
 8 / 0,15

C-64 cm. 39,5x 51x 47,5h
 06440420

766,00
 9 / 0,19

ACCESSORI

MOD. _____ DESCRIZIONE/DESCRIPTION/BEZEICHNUNG/DESCRIPTION/DESCRIPCIÓN POTENZA/POWER/LEISTUNG/PUISSANCE/POTENCIA ⚡kW ⚡kw PREZZO/PRICE €
 COD. _____ DIMENSIONI/DIMENSIONS/ABMESSUNGEN/DIMENSIONS/DIMENSIONES VOLTAGGIO/VOLTAGE/SPANNUNG/VOLTAGE/VOLTAJE kcal/h V- Hz PREIS/PRIX/PRECIO KG / M³

C-66 cm. 59,5x 51x 47,5h
 06440620



895,00
 14 / 0,28

R-63 RIPIANO 300
 06450300 **EN** Shelf 300 • **DE** Zwischenboden 300 • **FR** Etagère 300 • **ES** ESTANTE 300
 cm. 25x 48x 2h

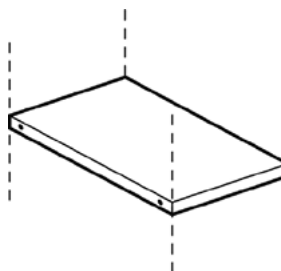

90,00
 1,5 / 0,01

R-64 RIPIANO 400
 06450400 **EN** Shelf 400 • **DE** Abstellbrett 400 • **FR** Etagère 400 • **ES** ESTANTE 400
 cm. 35x 48x 2h

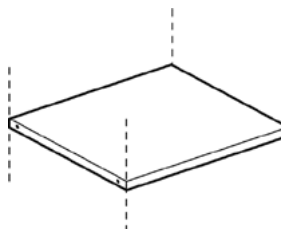

100,00
 2,5 / 0,01

R-66 RIPIANO 600
 06450600 **EN** Shelf 600 • **DE** Abstellbrett 600 • **FR** Etagère 600 • **ES** ESTANTE 600
 cm. 55x 48x 2h

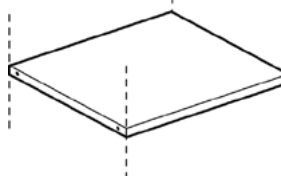

113,00
 3 / 0,01

544023800 RASCHIETTO PER PIASTRA RIGATA
EN Scraper for grooved plate • **DE** Schaber für gerillte Kochplatte
 • **FR** Racloir pour plaque nervurée • **ES RASQUETA PARA PLACA RANURADA**



69,00
 / 1,00

531040800 RASCHIETTO PER PIASTRA LISCIA AL CROMO LUCIDO
EN Scraper for smooth POLISHED CHROME plate • **DE** Schaber für glatte POLIERTEM CHROM Platte • **FR** Racloir pour plaque lisse au CHROME POLI • **ES RASQUETA PARA PLACA LISA DE CROMO PULIDO**



63,00
 / 1,00

531040900 KIT 10 LAME PER RASCHIETTO cod.531040800
EN 10 blades kit for scraper cod.531040800 • **DE** Kit 10 klingen für Schaber cod.531040800 • **FR** Kit de 10 lames pour racloir cod.531040800 • **ES KIT DE 10 CUCHILLAS PARA RASQUETA COD.531040800**

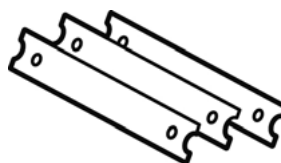





45,00
 / 0,00

ACCESSORI FRY-TOP

MOD. COD.	DESCRIZIONE/DESCRIPTION/BEZEICHNUNG/DESCRIPTION/DESCRIPCIÓN DIMENSIONI/DIMENSIONS/ABMESSUNGEN/DIMENSIONS/DIMENSIONES	POTENZA/POWER/LEISTUNG/PUISSANCE/POTENCIA VOLTAGGIO/VOLTAGE/SPANNUNG/VOLTAGE/VOLTAJE	$\frac{kW}{kcal/h}$ / $\frac{kW}{V\sim}$ Hz	PREZZO/PRICE € PREIS/PRIX/PRECIO € KG / M ³
T-FT 09580060	TAPPO PER FRY-TOP EN stopper for Fry-top • DE Stopfen griddleplatte • FR bouchon pour Plaque • ES TAPÓN FRY-TOP cm. 10x 2x 5h			268,00 / 0,00
PFT-64 06620400	KIT PROTEZIONE FRONTALE PIANO FRY-TOP EN KIT front protection plan fry-top • DE Schutz-kit vorne Plan griddleplatte • FR KIT protection avant plan plaque • ES KIT DE PROTECCIÓN FRONTAL PLAN DE FRY-TOP cm. 38x 8x 6h			137,00 / 0,00
PFT-66 06620600	cm. 58x 8x 6h			186,00 / 0,01
PFT-68 06620800	cm. 78x 8x 6h			233,00 / 0,01
PFT-610 06621000	cm. 98x 8x 6h			265,00 / 0,01
CG-60 06560000	COPRIGIUNTO EN Joint cover • DE Klemmsteg • FR Couvre-joint • ES CUBRE JUNTA cm. 0,7x 52x 1,2h			38,00 0.12 / 1,00
06550400	COPERCHIO BRF-64 EN Lid BRF-64 • DE Deckel BRF-64 • FR Couvercle BRF-64 • ES TAPA BRF-64 cm. 33x 45x 5h			150,00 / 0,02
06550600	COPERCHIO BRT-66 EN Lid BRF-66 • DE Deckel BRF-66 • FR Couvercle BRF-66 • ES TAPA BRF-66 cm. 51x 42x 3h			151,00 / 0,02
TG-63 06580300	TAGLIERE PLASTICA EN Plastic chopping-board • DE Schneidebrett • FR Plan de decoupe • ES PICADOR DE PLÁSTICO cm. 29x 52,5x 2,5h			138,00 4 / 0,01
TG-64 06580400	cm. 39x 52,5x 2,5h			151,00 6 / 0,01
TG-66 06580600	cm. 59x 52,5x 2,5h			253,00 9 / 0,01
TG-68 06580800	cm. 79x 52,5x 2,5h			297,00 11 / 0,02
PLF/62 06590421	PIASTRA LISCIA 2 FUOCHI EN Smooth griddle plate 2 burners • DE Fortkochplatte glatt 2 Kochstellen • FR Plaque lisse 2 feux • ES PLANCHA LISA 2 QUEMADORES cm. 29x 50			246,00 15 / 0,01

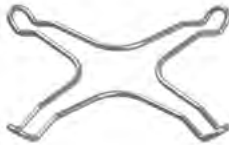
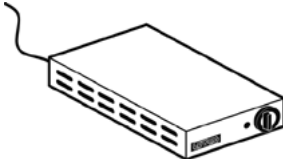
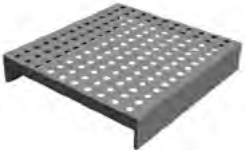
ACCESSORI

MOD. COD.	DESCRIZIONE/DESCRIPTION/BEZEICHNUNG/DESCRIPTION/DESCRIPCIÓN DIMENSIONI/DIMENSIONS/ABMESSUNGEN/DIMENSIONS/DIMENSIONES	POTENZA/POWER/LEISTUNG/PUISSANCE/POTENCIA VOLTAGGIO/VOLTAGE/SPANNUNG/VOLTAGE/VOLTAGE kW kcal/h	PREZZO/PRICE PREIS/PRIX/PRECIO € KG / M ³
PRF/62 06590423	PIASTRA RIGATA 2 FUOCHI EN Grooved griddle plate 2 burners • DE Fortkochplatte gerillt 2 Kochstellen • FR Plaque nervurée 2 feux • ES PLANCHA ESTRIADA 2 QUEMADORES cm. 29x 50		361,00 15 / 0,01
533009100	GRIGLIA DI RIDUZIONE EN Reduction • DE Reduzierstern • FR Grille de réduction • ES REJILLA DE REDUCCIÓN cm. 15x 15		24,00 0,2 / 0,00
533009200	GRIGLIA DI RIDUZIONE PER PC1/2/3T E CF2/3 EN Reduction PC1/2/3T & CF2/3 • DE Reduzierstern PC1/2/3T & CF2/3 • FR Grille de réduction PC1/2/3T & CF2/3 • ES REJILLA DE REDUCCIÓN PC1/2/3T & CF2/3 cm. 25x 25		43,00 0.2 / 0,00
RV 08660410	RISCALDANTE VANO EN Heater for cabinet • DE Heizer für Schrankelement • FR Réchauffeur pour armoire • ES ELEMENTO DE CALEFACCIÓN PARA ARMARIO NEUTRO cm. 32x 48,5x 8h		975,00 0,75 kW 230V~ 50/60 Hz 8 / 0,08
RRV-64 06450401	RIPIANO FORATO IN APPOGGIO PER RISCALDANTE (NO CF) EN Perforated shelf for heater element mod.RV (NO CF) • DE regale Gelocht für Heizer mod.RV (NO CF) • FR Étagère perforées pour réchauffeur mod.RV (NO CF) • ES ESTANTE PERFORADO PARA ELEMENTO DE CALEFACCION MOD.RV (NO CF) cm. 34x 46x 10h		337,00 4 / 0,02
RRV-66 06450601	cm. 54x 46x 10h		507,00 5 / 0,04
RRV-67 06450701	cm. 64x 46x 10h		637,00 6 / 0,04
RRV-68 06450801	cm. 74x 46x 10h		649,00 7 / 0,05
RRV-69 06450901	cm. 84x 46x 10h		816,00 8 / 0,06
RRV-610 06451001	cm. 94x 46x 10h		918,00 10 / 0,06
RRV-612 06451201	cm. 114x 46x 10h		1.093,00 12 / 0,08

ACCESSORI

MOD. _____ **DESCRIZIONE/DESCRIPTION/BEZEICHNUNG/DESCRIPTION/DESCRIPCIÓN** **POTENZA/POWER/LEISTUNG/PUISSANCE/POTENCIA** $\frac{kW}{kcal/h}$ $\frac{kW}{V\sim}$ **PREZZO/PRICE** €
COD. _____ **DIMENSIONI/DIMENSIONS/ABMESSUNGEN/DIMENSIONS/DIMENSIONES** **VOLTAGGIO/VOLTAGE/SPANNUNG/VOLTAGE/VOLTAGE** Hz **PREIS/PRIX/PRECIO** KG / M³

KIT-WOK 09580040 KIT WOK - fiamma verticale - solo su bruciatore da 10 kW e griglie in ghisa
EN KIT WOK - vertical flame - only for 10 kW burner and cast iron grills
 • **DE** KIT WOK - vertikaler Flamme - nur 10 kW-Brenner und Roste aus Gusseisen • **FR** KIT WOK - verticale de la flamme - seulement 10 kW brûleur et grilles en fonte • **ES KIT WOK - LLAMA VERTICAL - SÓLO 10 KW QUEMADOR Y PARRILAS DE HIERRO COLADO**
cm. Ø 26x 16h



456,00
5 / 0,02

544439900 ANELLO PER WOK - solo per griglie in ghisa
EN Wok ring - only for cast iron grills • **DE** Wok Aufsatzring - nur für Roste aus Gusseisen • **FR** Anneau Wok - seulement pour grilles en fonte • **ES ANILLO WOK - SOLO PARA PARRILAS DE HIERRO COLADO**
cm. Ø22,5x 3,5h



170,00
2 / 0,00

SIA-7/9 08480000 STAFFA INFERIORE UNIONE APPARECCHI
EN Lower bracket to join two items



64,00
2 / 0,00

SR-100 50900001 SET 4 RUOTE Ø 100x30, 2 con freno
EN Set of 4 wheels Ø 100x30, 2 with brake • **DE** 4 Rollen Satz Ø 100x30, 2 davon mit Feststellbremse • **FR** Kit 4 roues Ø 100x30, 2 avec frein • **ES EQUIPO 4 RUEDAS Ø 100X30, 2 CON FRENOS**
cm. 12,7h

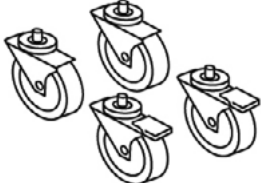

383,00
1 / 0,01

ZB 01410000 ZOCCOLATURA BASE
EN FRONT PLINTH • **DE** GRUNDSOCKEL • **FR** PLINTHE FRONTAL • **ES ZOCCOLOS BASE**
€/m x cm. 15h

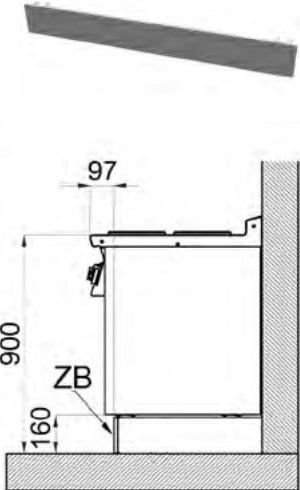
154,00
/

ZA 01410002 ZOCCOLATURA ANGOLO
EN CORNER PLINTH • **DE** EKE-SOCKEL • **FR** PLINTHE ANGLE • **ES ZOCCOLOS ANGULAR**
cm. 15h

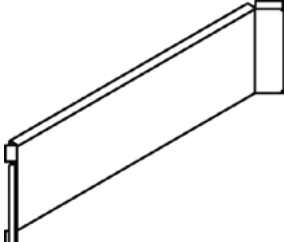

93,00
0.3 / 0,01

ACCESSORI

MOD. _____
COD. _____

DESCRIZIONE/DESCRIPTION/BEZEICHNUNG/DESCRIPTION/DESCRIPCIÓN
DIMENSIONI/DIMENSIONS/ABMESSUNGEN/DIMENSIONS/DIMENSIONES

POTENZA/POWER/LEISTUNG/PUISSANCE/POTENCIA
VOLTAGGIO/VOLTAGE/SPANNUNG/VOLTAGE/VOLTAGE

⚡ kW kcal/h
⚡ kw V- Hz

PREZZO/PRICE €
PREIS/PRIX/PRECIO €
KG / M²

D-60
06470000

DIVISORIO - Necessario per applicare cassetiera C-64 su mobile 70/80
EN Spacer - For installation of a C-64 on a stand 70/80 • **DE**
Trennwand - Um ein C-64 an einem Unterschrank 70/80 einzubauen
• **FR** Separation - Pour l'installation de C-64 sur placard 70/80 • **ES**
DIVISORIO - NECESARIO PARA APLICAR CAJONERAS C-64
EN MUEBLE 70/80
cm. 5x 48x 38h

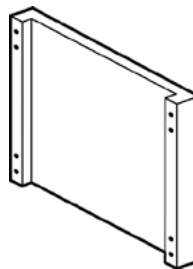

164,00
2 / 0,02

PT-64
06460002

PORTATEGLIE VANO - 400 (GN2/3) - VANO 600 (GN1/1)
EN Frame for oven plates. 400 GN 2/3 - 600 GN 1/1 • **DE**
Auflangeschienen für Backbleche. 400 GN 2/3 - 600 GN 1/1 • **FR** Kit
porte-plaques. 400 GN 2/3 - 600 GN 1/1 • **ES** PORTACAZUELAS.
400 GN 2/3 - 600 GN 1/1
cm. 2x 47x 30h

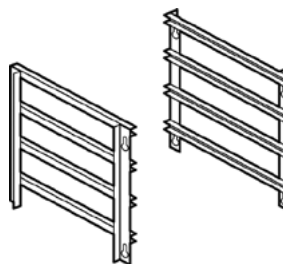

347,00
2.5 / 0,01

06570401

GRIGLIA TONDINO per CW64 (SERIE 60)
EN Grid for CW-64 (60 line) • **DE** Gitter für CW-64 (60. Serie) • **FR**
Grille ronde pour CW-64 (serie 60) • **ES** REJILLA PARA CW-64
(SERIE 60)
cm. 38x 42



410,00
9 / 0,02
18,28
Ø6

06570601

GRIGLIA TONDINO per CW66 (SERIE 60)
EN Grid for CW-66 (60 line) • **DE** Gitter für CW-66 (60. Serie) • **FR**
Grille ronde pour CW-66 (serie 60) • **ES** REJILLA PARA CW-66
(SERIE 60)
cm. 58x 42



584,00
9 / 0,03
18,28
Ø6

06570402

GRIGLIA TEGOLO V per CW-64 (SERIE 60)
EN V TRAY for CW-64 (60 LINE) • **DE** V ROSTE FÜR CW-64 (60
LINIE) • **FR** V GRILLE POUR CW-64 (LIGNE 60) • **ES** V REJILLA
PARA CW-64 (SERIE 60)
cm. 36x 43



280,00
9 / 0,02
5
23,5

06570602

GRIGLIA TEGOLO V per CW-66 (SERIE 60)
EN V TRAY for CW-66 (60 LINE) • **DE** V ROSTE FÜR CW-66 (60
LINIE) • **FR** V GRILLE POUR CW-66 (LIGNE 60) • **ES** V REJILLA
PARA CW-66 (SERIE 60)
cm. 56x 43



404,00
9 / 0,03
5
23,5

ACCESSORI CUOCIPASTA

MOD. _____ DESCRIZIONE/DESCRIPTION/BEZEICHNUNG/DESCRIPTION/DESCRIPCIÓN POTENZA/POWER/LEISTUNG/PUISSANCE/POTENCIA kW kcal/h $\frac{kW}{Hz}$ PREZZO/PRICE €
 COD. _____ DIMENSIONI/DIMENSIONS/ABMESSUNGEN/DIMENSIONS/DIMENSIONES VOLTAGGIO/VOLTAGE/SPANNUNG/VOLTAGE/VOLTAJE V~ Hz PREIS/PRIX/PRECIO €
 KG / M³

531017900 CESTO 1/3 PER CP-66
EN Basket 1/3 for CP-66 • **DE** Korb 1/3 für CP-66 • **FR** Panier 1/3 pour CP-66 • **ES CESTA 1/3 PARA CP-66**
cm. 16x 29x 20h

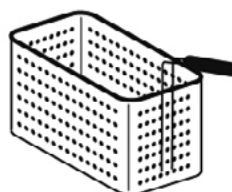

..179..

145,00
 1,5 / 0,05

531064300 CESTO 1/4 PER CP-66
EN Basket 1/4 for CP-66 • **DE** Korb 1/4 für CP-66 • **FR** Panier 1/4 pour CP-66 • **ES CESTA 1/4 PARA CP-66**
cm. 11,5x 29x 20h

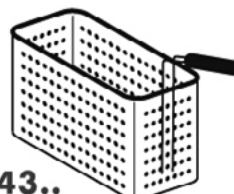

..643..

130,00
 1,2 / 0,04

531053900 CESTO 1/1 PER CP-66
EN Basket 1/1 for CP-66 • **DE** Korb 1/1 für CP-66 • **FR** Panier 1/1 pour CP-66 • **ES CESTA 1/1 PARA CP-66**
cm. 49x 29x 20h

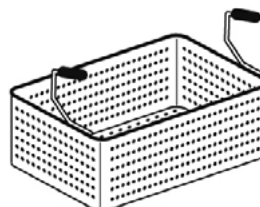

..539..

198,00
 3,5 / 0,08

531018800 CESTO 1/2 PER CPT-64 - 1/3 PER CPT-66
EN Basket 1/2 for CPT-64 - 1/3 for CPT-66 • **DE** Korb 1/2 für CPT-64 - 1/3 für CPT-66 • **FR** Panier 1/2 pour CPT-64 - 1/3 pour CPT-66 • **ES CESTA 1/2 PARA CPT-64 - 1/3 PARA CPT-66**
cm. 14,5x 29x 15h

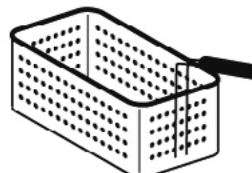

..188..

138,00
 1,3 / 0,04

531053800 CESTO 1/4 PER CPT-66
EN Basket 1/4 for CPT-66 • **DE** Korb 1/4 für CPT-66 • **FR** Panier 1/4 pour CPT-66 • **ES CESTA 1/4 PARA CPT-66**
cm. 11,5x 29x 15h

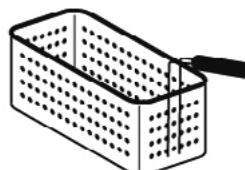

..538..

132,00
 1,2 / 0,04

531040000 CESTO 1/1 PER CPT-66
EN Basket 1/1 for CPT-66 • **DE** Korb 1/1 für CPT-66 • **FR** Panier 1/1 pour CPT-66 • **ES CESTA 1/1 PARA CPT-66**
cm. 49x 29x 15h

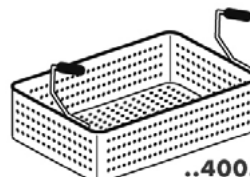

..400..

238,00
 3,5 / 0,07

531048900 CESTO 1/6 PER CPT-64
EN Basket 1/6 for CPT-64 • **DE** Korb 1/6 für CPT-64 • **FR** Panier 1/6 pour CPT-64 • **ES CESTA 1/6 PARA CPT-64**
cm. 14x 10x 15h



86,00
 1 / 0,01

ACCESSORI CUOCIPASTA

MOD. _____
COD. _____

DESCRIZIONE/DESCRIPTION/BEZEICHNUNG/DESCRIPTION/DESCRIPCIÓN
DIMENSIONI/DIMENSIONS/ABMESSUNGEN/DIMENSIONS/DIMENSIONES

POTENZA/POWER/LEISTUNG/PUISSANCE/POTENCIA
VOLTAGGIO/VOLTAGE/SPANNUNG/VOLTAGE/VOLTAJE

⚡ kW kcal/h ⚡ kw
V~ Hz

PREZZO/PRICE €
PREIS/PRIX/PRECIO €
KG / M³

531053700 CESTO 1/4 PER CPT-64
EN Basket 1/4 for CPT-64 • **DE** Korb 1/4 für CPT-64 • **FR** Panier 1/4 pour CPT-64 • **ES CESTA 1/4 PARA CPT-64**
cm. 14x 16x 15h

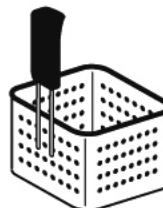

..537..

93,00
1 / 0,02

531053500 CESTO 1/1 PER CPT-64
EN Basket 1/1 for CPT-64 • **DE** Korb 1/1 für CPT-64 • **FR** Panier 1/1 pour CPT-64 • **ES CESTA 1/1 PARA CPT-64**
cm. 29x 29x 15h

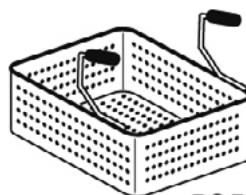

..535..

171,00
1,5 / 0,05

531071300 CESTO CON GANCIO 1/2 PER CPT-64 - 1/3 PER CPT-66
EN Basket with hook 1/2 for CPT-64 - 1/3 for CPT-66 • **DE** Korb mit Haken 1/2 für CPT-64 - 1/3 für CPT-66 • **FR** Panier avec crochet 1/2 pour CPT-64 - 1/3 pour CPT-66 • **ES CESTA CON GANCHO 1/2 PARA CPT-64 - 1/3 PARA CPT-66**
cm. 13,5x 25,5x 15h



137,00
1,3 / 0,04

531071400 CESTO CON GANCIO 1/4 PER CPT-66
EN Basket with hook 1/4 for CPT-66 • **DE** Korb mit Haken 1/4 für CPT-66 • **FR** Panier avec crochet 1/4 pour CPT-66 • **ES CESTA CON GANCHO 1/4 PARA CPT-66**
cm. 11x 25,5x 15h

130,00
1,2 / 0,03

531071200 CESTO CON GANCIO 1/3 PER CP-66
EN Basket with hook 1/3 for CP-66 • **DE** Korb mit Haken 1/3 für CP-66 • **FR** Panier avec crochet 1/3 pour CP-66 • **ES CESTA CON GANCHO 1/3 PARA CP-66**
cm. 15x 26x 20h

158,00
1,5 / 0,05

531018700 CESTO CON GANCIO 1/4 PER CP-66
EN Basket with hook 1/4 for CP-66 • **DE** Korb mit Haken 1/4 für CP-66 • **FR** Panier avec crochet 1/4 pour CP-66 • **ES CESTA CON GANCHO 1/4 PARA CP-66**
cm. 11x 26x 20h

131,00
1,2 / 0,04

531069400 GRIGLIA SUPPORTO CESTI CON GANCIO PER CP-66
EN support for baskets with hook for CP-66 • **DE** Unterstützung für Körbe mit Haken für CP-66 • **FR** soutien pour les paniers avec crochet pour CP-66 • **ES SOPORTE PARA CESTAS CON GANCHO PARA CP-66**
cm. 50x 29x 41h

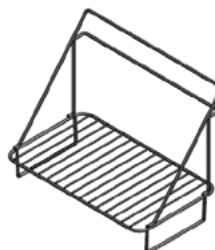

195,00
4 / 0,09

531071800 GRIGLIA SUPPORTO CESTI CON GANCIO PER CPT-64
EN support for baskets with hook for CPT-64 • **DE** Unterstützung für Körbe mit Haken für CPT-64 • **FR** soutien pour les paniers avec crochet pour CPT-64 • **ES SOPORTE PARA CESTAS CON GANCHO PARA CPT-64**
cm. 30x 33x 25h



138,00
3 / 0,04

ACCESSORI CUOCIPASTA

MOD. COD.	DESCRIZIONE/DESCRIPTION/BEZEICHNUNG/DESCRIPTION/DESCRIPCIÓN DIMENSIONI/DIMENSIONS/ABMESSUNGEN/DIMENSIONS/DIMENSIONES	POTENZA/POWER/LEISTUNG/PUISSANCE/POTENCIA VOLTAGGIO/VOLTAGE/SPANNUNG/VOLTAGE/VOLTAJE	⊕kW kcal/h	⊕kW V~ Hz	PREZZO/PRICE € PREIS/PRIX/PRECIO € KG / M³
531071900	GRIGLIA SUPPORTO CESTI CON GANCIO PER CPT-66 EN support for baskets with hook for CPT-66 • DE Unterstützung für Körbe mit Haken für CPT-66 • FR soutien pour les paniers avec crochet pour CPT-66 • ES SOPORTE PARA CESTAS CON GANCHO PARA CPT-66 cm. 50x 30x 25h				179,00 3,5 / 0,06
531013200	CESTO 1/2 PER F13-64E / F10T-63E EN Basket 1/2 for F13-64E / F10T-63E • DE Korb 1/2 für F13-64E / F10T-63E • FR Panier 1/2 pour F13-64E / F10T-63E • ES CESTA 1/2 PARA F13-64E / F10T-63E cm. 10x 30x 12h				63,00 0.7 / 0,03
531053300	CESTO 1/2 PER F13-64G EN Basket 1/2 for F13-64G • DE Korb 1/2 für F13-64G • FR Panier 1/2 pour F13-64G • ES CESTA 1/2 PARA F13-64G cm. 15x 27x 12h				85,00 0.7 / 0,04
SA-62 06600200	SCHIENA POSTERIORE A VISTA PER APPARECCHI EN Back cover • DE Ruckenwand • FR Dos de finition • ES PANEL POSTERIOR cm. 20x 1,5x 81h				112,00 2 / 0,01
SA-63 06600300	cm. 30x 1,5x 81h				127,00 3 / 0,01
SA-64 06600400	cm. 40x 1,5x 81h				146,00 3 / 0,01
SA-66 06600600	cm. 60x 1,5x 81h				212,00 4 / 0,02
SA-68 06600800	cm. 80x 1,5x 81h				247,00 5 / 0,02
SA-610 06601000	cm. 100x 1,5x 81h				308,00 6 / 0,03
SA-612 06601200	cm. 120x 1,5x 81h				372,00 7 / 0,03
SA-63FG 06600301	SCHIENA POSTERIORE A VISTA PER FRIGGITRICI GAS EN Back cover for Gas Fryer • DE Ruckenwand für Gas-Friteuse • FR Dos de finition pour Friteuse a gaz • ES PANEL POSTERIOR PARA FREIDORAS A GAS cm. 30x 1,5x 90h				135,00 3 / 0,01
SA-66FG 06600601	cm. 60x 1,5x 90h				226,00 4 / 0,02

ACCESSORI

MOD. _____ DESCRIZIONE/DESCRIPTION/BEZEICHNUNG/DESCRIPTION/DESCRIPCIÓN POTENZA/POWER/LEISTUNG/PUISSANCE/POTENCIA ⚡kw ⚡kw PREZZO/PRICE €
 COD. _____ DIMENSIONI/DIMENSIONS/ABMESSUNGEN/DIMENSIONS/DIMENSIONES VOLTAGGIO/VOLTAGE/SPANNUNG/VOLTAGE/VOLTAJE kcal/h V~ Hz PREIS/PRIX/PRECIO €
 KG / M³

KIT-TOPM-SA 08600001 KIT TAMPONAMENTI LATERALI per schiena posteriore montata su apparecchi TOP e mobili "M..."
EN Side KIT for back cover mounted on the TOP machine and Stand "M..." • **DE** Seitliches KIT für Rückenwand montiert auf der TOP-Maschine und Unterbau "M..." • **FR** KIT latéral pour Dos de finition monté sur la machine TOP et Placard "M..." • **ES KIT LATERAL PARA PANEL POSTERIORE MONTADO EN LA MÁQUINA TOP Y MUEBLE BASE "M..."**



99,00
1 / 0,01

TMA-6SX 06540601 TESTATA 1 LATO SERIE 60 SINISTRA
EN Head 1 side S60 left • **DE** Abschluss element 1 seite S60 links • **FR** Element de jonction 1 coté S60 gauche • **ES EMBELLECEDOR 1 LADO S60 IZQUIERDA**
cm. 0,2x 60



267,00
7 / 0,02

TMA-6DX 06540600 TESTATA 1 LATO SERIE 60 DESTRA
EN Head 1 side S60 right • **DE** Abschluss element 1 seite S60 recht • **FR** Element de jonction 1 coté S60 droit • **ES EMBELLECEDOR 1 LADO S60 DERECHA**
cm. 0,2x 60



267,00
7 / 0,02

TMA-66 06546600 TESTATA 2 LATI SERIE 60
EN Head 2 sides S60 • **DE** Abschluss element seiten S60 • **FR** Element de jonction 2 cotés S60 • **ES EMBELLECEDOR 2 LADOS S60**
cm. 0,2x 120



534,00
14 / 0,04

TMA-67SX 06546701 TESTATA 2 LATI SERIE 60/70 SINISTRA
EN Head 2 sides S60/70 left • **DE** Abschluss element seiten S60/70 links • **FR** Element de jonction 2 cotés S60/70 gauche • **ES EMBELLECEDOR 2 LADOS S60/70 IZQUIERDA**
cm. 0,2x 130,5



545,00
15 / 0,04

TMA-67DX 06546700 TESTATA 2 LATI SERIE 60/70 DESTRA
EN Head 2 sides S60/70 right • **DE** Abschluss element seiten S60/70 recht • **FR** Element de jonction 2 cotés S60/70 droit • **ES EMBELLECEDOR 2 LADOS S60/70 DERECHA**
cm. 0,2x 130,5



545,00
15 / 0,04

ACCESSORI

MOD. _____ COD. _____	DESCRIZIONE/DESCRIPTION/BEZEICHNUNG/DESCRIPTION/DESCRIPCIÓN DIMENSIONI/DIMENSIONS/ABMESSUNGEN/DIMENSIONS/DIMENSIONES	POTENZA/POWER/LEISTUNG/PUISSANCE/POTENCIA VOLTAGGIO/VOLTAGE/SPANNUNG/VOLTAGE/VOLTAGE	$\frac{\text{kW}}{\text{kcal/h}}$ $\frac{\text{kV}}{\text{V}}$ Hz	PREZZO/PRICE € PREIS/PRIX/PRECIO € KG / M ³
--	---	---	--	---

TMA-69SX TESTATA 2 LATI SERIE 60/90 SINISTRA
06546901 **EN** Head 2 sides S60/90 left • **DE** Abschluss element seiten S60/90 links • **FR** Element de jonction 2 cotés S60/90 gauche • **ES** **EMBELLECEDOR 2 LADOS S60/90 IZQUIERDA**
cm. 0,2x 150



575,00
16 / 0,04

TMA-69DX TESTATA 2 LATI SERIE 60/90 DESTRA
06546900 **EN** Head 2 sides S60/90 right • **DE** Abschluss element seiten S60/90 recht • **FR** Element de jonction 2 cotés S60/90 droit • **ES** **EMBELLECEDOR 2 LADOS S60/90 DERECHA**
cm. 0,2x 150



575,00
16 / 0,04

BCC BLOCCO COTTURA CARRELLATO Composto da: BRS-161, F10T-63ET,
16000000 PLT-64, TG-64, FTLRT-66ET, PLT-63, HP-4, TS-6
EN Cooking unit on trolley - Made of: BRS-161, F10T-63ET, PLT-64, TG-64, FTLRT-66ET, PLT-63, HP-4, TS-6 • **DE** Kochvorrichtung mit Fahrbarem gestell Anbauteile: BRS-161, F10T-63ET, PLT-64, TG-64, FTLRT-66ET, PLT-63, HP-4, TS-6 • **FR** Bloc cuisson roulant - Elements de composition: BRS-161, F10T-63ET, PLT-64, TG-64, FTLRT-66ET, PLT63, HP-4, TS-6 • **ES** **BLOQUE COCCIÓN CON RUEDAS - COMPUESTO POR: BRS-161, F10T-63ET, PLT-64, TG-64, FTLRT-66ET, PLT-63, HP-4, TS-6**
cm. 220x 65x 110h



$\frac{\text{kW}}{\text{kcal/h}}$ $\frac{\text{kV}}{\text{V}}$
15,48 kW **17.235,00**
400V~3N 260 / 2,29
230V~3
50 Hz

Infografía - Infographic

Cocina modular Línea 60 - Modular kitchen Gamme 60

NUEVO
NEW



NOVEDADES EN LÍNEAS 60 - 70 - 90



NUEVO DISEÑO DE ASAS

Para muebles de conjuntos en Líneas 60, 70 y 90 de LOTUS



COLOR PERSONALIZADO

Indícanos el RAL del color que deseas y colorea tu cocina.

SHINE KITCHEN 60

SHINE KITCHEN

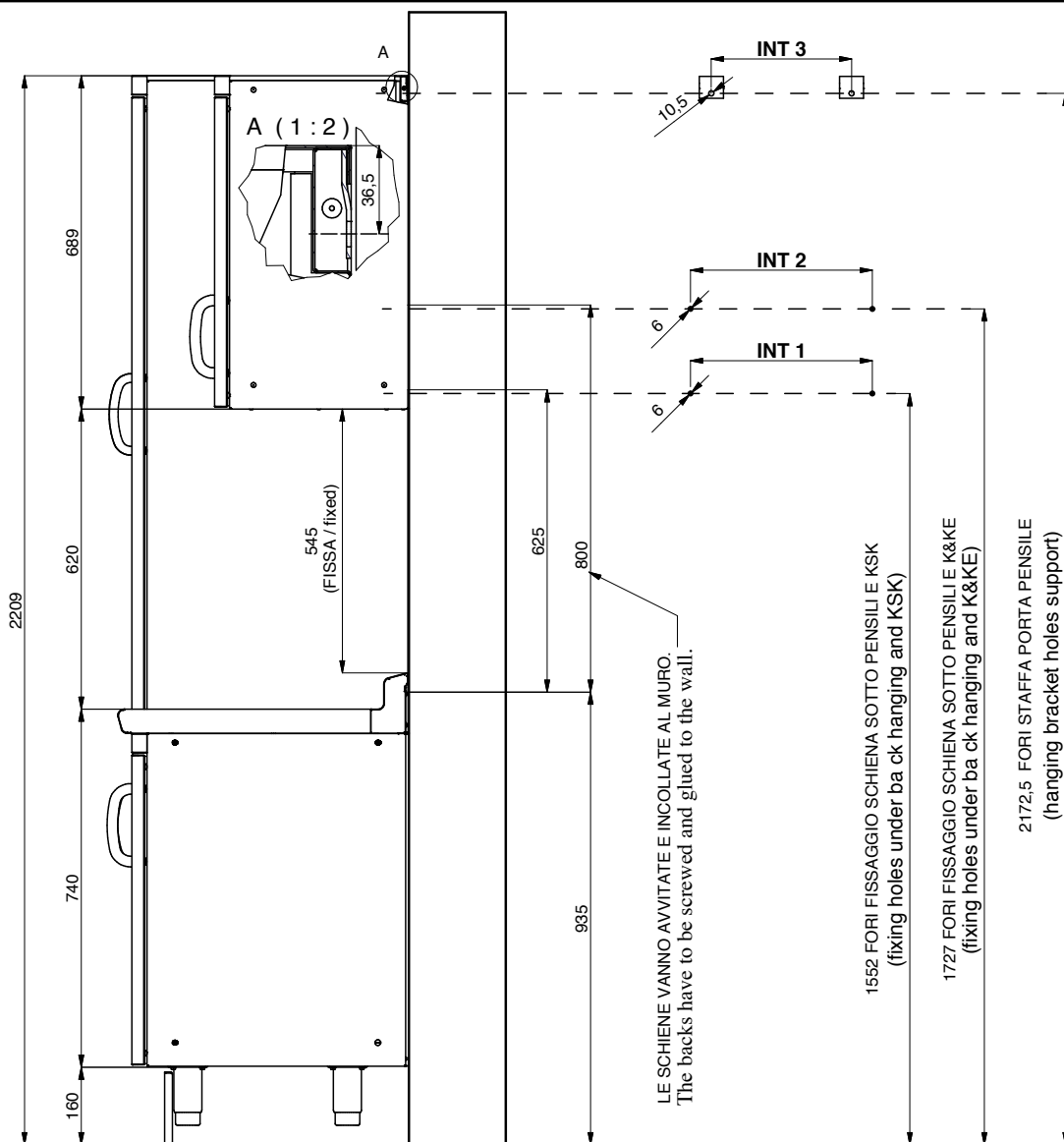

Tabella

MOD. SP	INT 1	INT 2	MOD. PP	INT 3
SP/630	276	-	PP-630 SX/DX	190
SP/640	376	-	PP-640 SX/DX	290
SP/645	426	-	PP-645 SX/DX	340
SP/650	476	-	PP-650 SX/DX	390
SP/670	676	-	PP-660/PPS-660	490
SP/6105	1026	-	PP-670	590
SP/6110	1076	-	PP-680	690
SP/6125	1226	-	PP-690/PPS-690	790
SP/6135	1326	-	PP-6100	890
SP-SK/660		576	PP-6105	940
SP-SK/680		776	PP-6110	990
SP-SK/690		876	PP-6120	1090
SP-SK/6100		976	PP-6125	1140
SP-SK/6120		1176	PP-6135	1240
SP-SK/6140		1376	PP-6150	1390
SP-SK/6150		1476	-	
SP-SK/6160		1576	-	
SP-SK/6180		1776	-	

CASSETTIERE

MOD. COD.	DESCRIZIONE/DESCRIPTION/BEZEICHNUNG/DESCRIPTION/DESCRIPCIÓN DIMENSIONI/DIMENSIONS/ABMESSUNGEN/DIMENSIONS/DIMENSIONES	POTENZA/POWER/LEISTUNG/PUISSANCE/POTENCIA VOLTAGGIO/VOLTAGE/SPANNUNG/VOLTAGE/VOLTAJE	kw kcal/h	kw V~ Hz	PREZZO/PRICE € PREIS/PRIX/PRECIO € KG / M³
BC1/660 01070601	1 CASSETTO cm.51,8x52x57,2 EN 1 DRAWER cm.51,8x52x57,2 • DE 1 SCHUBLADEN cm.51,8x52x57,2 • FR 1 TIROIR cm.51,8x52x57,2 • ES 1 CAJONE CM.51,8X52X57,2 cm. 60x 56,6x 81h				1.406,00 41 / 0,40
BC2/640 01070402	2 CASSETTI cm.31,8x52x25 EN 2 DRAWERS cm.31,8x52x25 • DE 2 SCHUBLADEN cm.31,8x52x25 • FR 2 TIROIRS cm.31,8x52x25 • ES 2 CAJONES CM.31,8X52X25 cm. 40x 56,6x 81h				1.315,00 35 / 0,28
BC2/645 01070452	2 CASSETTI cm.36,8x52x25 EN 2 DRAWERS cm.36,8x52x25 • DE 2 SCHUBLADEN cm.36,8x52x25 • FR 2 TIROIRS cm.36,8x52x25 • ES 2 CAJONES CM.36,8X52X25 cm. 45x 56,6x 81h				1.452,00 37.5 / 0,31
BC2/650 01070502	2 CASSETTI cm.41,8x52x25 EN 2 DRAWERS cm.41,8x52x25 • DE 2 SCHUBLADEN cm.41,8x52x25 • FR 2 TIROIRS cm.41,8x52x25 • ES 2 CAJONES CM.41,8X52X25 cm. 50x 56,6x 81h				1.565,00 40 / 0,34
BC2/660 01070602	2 CASSETTI cm.51,8x52x25 EN 2 DRAWERS cm.51,8x52x25 • DE 2 SCHUBLADEN cm.51,8x52x25 • FR 2 TIROIRS cm.51,8x52x25 • ES 2 CAJONES CM.51,8X52X25 cm. 60x 56,6x 81h				1.665,00 44 / 0,40
BC3/640 01070403	3 CASSETTI cm.31,8x52x14,3 EN 3 DRAWERS cm.31,8x52x14,3 • DE 3 SCHUBLADEN cm.31,8x52x14,3 • FR 3 TIROIRS cm.31,8x52x14,3 • ES 3 CAJONES CM.31,8X52X14,3 cm. 40x 56,6x 81h				1.363,00 39 / 0,28
BC3/645 01070453	3 CASSETTI cm.36,8x52x14,3 EN 3 DRAWERS cm.36,8x52x14,3 • DE 3 SCHUBLADEN cm.36,8x52x14,3 • FR 3 TIROIRS cm.36,8x52x14,3 • ES 3 CAJONES CM.36,8X52X14,3 cm. 45x 56,6x 81h				1.644,00 41.5 / 0,31
BC3/650 01070503	3 CASSETTI cm.41,8x52x14,3 EN 3 DRAWERS cm.41,8x52x14,3 • DE 3 SCHUBLADEN cm.41,8x52x14,3 • FR 3 TIROIRS cm.41,8x52x14,3 • ES 3 CAJONES CM.41,8X52X14,3 cm. 50x 56,6x 81h				1.764,00 43 / 0,34
BC4/630 01070304	4 CASSETTI cm.21,8x52x8,9 EN 4 DRAWERS cm.21,8x52x8,9 • DE 4 SCHUBLADEN cm.21,8x52x8,9 • FR 4 TIROIRS cm.21,8x52x8,9 • ES 4 CAJONES CM.21,8X52X8,9 cm. 30x 56,6x 81h				1.452,00 37 / 0,22

CASSETTIERE

MOD. COD.	DESCRIZIONE/DESCRIPTION/BEZEICHNUNG/DESCRIPTION/DESCRIPCIÓN DIMENSIONI/DIMENSIONS/ABMESSUNGEN/DIMENSIONS/DIMENSIONES	POTENZA/POWER/LEISTUNG/PUISSANCE/POTENCIA VOLTAGGIO/VOLTAGE/SPANNUNG/VOLTAGE/VOLTAJE	⚡ kcal/h kw V~ Hz	PREZZO/PRICE PREIS/PRIZ/PRECIO € KG / M³
BC4/640 01070404	4 CASSETTI cm.31,8x52x8,9 EN 4 DRAWERS cm.31,8x52x8,9 • DE 4 SCHUBLADEN cm.31,8x52x8,9 • FR 4 TIROIRS cm.31,8x52x8,9 • ES 4 CAJONES CM.31,8X52X8,9 cm. 40x 56,6x 81h			1.543,00 42 / 0,28
BC4/645 01070454	4 CASSETTI cm.36,8x52x8,9 EN 4 DRAWERS cm.36,8x52x8,9 • DE 4 SCHUBLADEN cm.36,8x52x8,9 • FR 4 TIROIRS cm.36,8x52x8,9 • ES 4 CAJONES CM.36,8X52X8,9 cm. 45x 56,6x 81h			1.838,00 43.5 / 0,31
BC2B/640 01080402	2 BACINELLE INOX GN 1/1 h20 EN 2 CONTAINERS INOX GN 1/1 h20 • DE 2 BEHALTERN INOX GN 1/1 h20 • FR 2 BACS INOX GN 1/1 h20 • ES 2 CONTENEDORES INOX GN 1/1 H20 cm. 40x 56,6x 81h			1.479,00 34 / 0,28
BP/630SX 01010301	BASE CON PORTA E RIPIANO INTERMEDIO EN STORAGE UNIT WITH DOOR AND MIDDLE SHELF • DE FLUGELTURELEMENT MIT ZWISCHENBORD • FR ELEMENT DE BASE AVEC PORTE ET ETAGERE INTERMEDIAIRE • ES BASE CON PUERTA Y ESTANTE INTERMEDIO cm. 30x 56,6x 81h			753,00 18 / 0,22
BP/640SX 01010401	cm. 40x 56,6x 81h			770,00 21 / 0,28
BP/645SX 01010451	cm. 45x 56,6x 81h			808,00 22.5 / 0,31
BP/650SX 01010501	cm. 50x 56,6x 81h			819,00 24 / 0,34
BP/630DX 01010300	cm. 30x 56,6x 81h			753,00 18 / 0,22
BP/640DX 01010400	cm. 40x 56,6x 81h			770,00 21 / 0,28
BP/645DX 01010450	cm. 45x 56,6x 81h			808,00 22.5 / 0,31
BP/650DX 01010500	cm. 50x 56,6x 81h			819,00 24 / 0,34
BP/660 01010600	BASE CON PORTE, GUARNIZIONE E RIPIANO INTERMEDIO EN STORAGE UNIT WITH DOORS , GASKET AND MIDDLE SHELF • DE FLUGELTURELEMENT MIT TURDICHTUNG UND ZWISCHENBORD • FR ELEMENT DE BASE AVEC PORTES , JOINT ET ETAGERE INTERMEDIAIRE • ES BASE CON PUERTAS, GUARNICION Y ESTANTE INTERMEDIO cm. 60x 56,6x 81h			1.078,00 28 / 0,40
BP/670 01010700	cm. 70x 56,6x 81h			1.119,00 32 / 0,46

MOBILI BASE

MOD. COD.	DESCRIZIONE/DESCRIPTION/BEZEICHNUNG/DESCRIPTION/DESCRIPCIÓN DIMENSIONI/DIMENSIONS/ABMESSUNGEN/DIMENSIONS/DIMENSIONES	POTENZA/POWER/LEISTUNG/PUISSANCE/POTENCIA VOLTAGGIO/VOLTAGE/SPANNUNG/VOLTAGE/VOLTAJE	kw kcal/h	kw V~ Hz	PREZZO/PRICE € PREIS/PRIX/PRECIO KG / M³
BP/680 01010800	cm. 80x 56,6x 81h				1.169,00 36 / 0,51
BP/690 01010900	cm. 90x 56,6x 81h				1.243,00 39 / 0,57
BP/6100 01011000	cm. 100x 56,6x 81h				1.307,00 42 / 0,63
BP/6105 01011050	BASE CON 3 PORTE, GUARNIZIONI E RIPIANO INTERMEDIO EN STORAGE UNIT WITH 3 DOORS , GASKETS AND MIDDLE SHELF • DE FLUGELTURELEMENT MIT 3 TUREN, TURDICHTUNGEN UND ZWISCHENBORD • FR ELEMENT DE BASE AVEC 3 PORTES , JOINTS ET ETAGERE INTERMEDIAIRE • ES BASE CON 3 PUERTAS, GUARNICION Y ESTANTE INTERMEDIO cm. 105x 56,6x 81h				1.556,00 43.5 / 0,66
BP/6110 01011100	cm. 110x 56,6x 81h				1.587,00 45 / 0,69
BP/6120 01011200	cm. 120x 56,6x 81h				1.644,00 48 / 0,75
BP/6125 01011250	cm. 125x 56,6x 81h				1.674,00 49.5 / 0,78
BP/6135 01011350	cm. 135x 56,6x 81h				1.736,00 52.5 / 0,83
BP/6150 01011500	cm. 150x 56,6x 81h				1.828,00 57 / 0,92
BPA/680 01110801	BASE AD ANGOLO CON PORTA E RIPIANO INTERMEDIO EN CORNER STORAGE UNIT WITH DOOR AND MIDDLE SHELF • DE ECK-ELEMENT 90° MIT TUR UND ZWISCHENBORD • FR ELEMENT DE BASE D'ANGLE AVEC PORTE ET ETAGERE INTERMEDIAIRE • ES BASE ANGULAR CON PUERTA Y ENTANTE INTERMEDIO cm. 80/80x 56,6x 81h				1.484,00 41 / 0,70
PL/630 01310300	PIANO LAVORO CON ALZATINA E BORDO FRONTALE ARROTONDATO EN WORKTOP WITH RAISED AND REAR BORDER • DE OBERPLATTE MIT AUFKANTUNG HINTEN UND PROFILE ABGERUNDET. • FR PLAN DE TRAVAIL AVEC JOINT DE FINITION POSTERIEUR ET BORDE FRONTAL TOMBE' • ES SOBRE DE TRABAJO CON PETO TRASERO Y BORDE FRONTAL REDONDEADO cm. 30x 60x 5h				212,00 5,5 / 0,05
PL/640 01310400	cm. 40x 60x 5h				242,00 7,5 / 0,06
PL/645 01310450	cm. 45x 60x 5h				272,00 8,5 / 0,07
PL/650 01310500	cm. 50x 60x 5h				287,00 9 / 0,08
PL/660 01310600	cm. 60x 60x 5h				299,00 11 / 0,09

PIANI LAVORO

MOD. COD.	DESCRIZIONE/DESCRIPTION/BEZEICHNUNG/DESCRIPTION/DESCRIPCIÓN DIMENSIONI/DIMENSIONS/ABMESSUNGEN/DIMENSIONS/DIMENSIONES	POTENZA/POWER/LEISTUNG/PUISSANCE/POTENCIA VOLTAGGIO/VOLTAGE/SPANNUNG/VOLTAGE/VOLTAJE	$\frac{\text{kcal}}{\text{h}}$ / $\frac{\text{kW}}{\text{h}}$ $\frac{\text{V}}{\text{Hz}}$	PREZZO/PRICE PREIS/PRIX/PRECIO € KG / M ³
PL/670 01310700	cm. 70x 60x 5h			333,00 13 / 0,10
PL/675 01310750	cm. 75x 60x 5h			346,00 13,5 / 0,11
PL/680 01310800	cm. 80x 60x 5h			377,00 14,5 / 0,11
PL/690 01310900	cm. 90x 60x 5h			391,00 16,5 / 0,13
PL/6100 01311000	cm. 100x 60x 5h			407,00 18,5 / 0,14
PL/6105 01311050	cm. 105x 60x 5h			422,00 19,5 / 0,15
PL/6110 01311100	cm. 110x 60x 5h			437,00 20 / 0,15
PL/6120 01311200	cm. 120x 60x 5h			451,00 22 / 0,17
PL/6125 01311250	cm. 125x 60x 5h			469,00 23 / 0,17
PL/6130 01311300	cm. 130x 60x 5h			482,00 24 / 0,18
PL/6135 01311350	cm. 135x 60x 5h			498,00 24,5 / 0,19
PL/6140 01311400	cm. 140x 60x 5h			540,00 25,5 / 0,19
PL/6150 01311500	cm. 150x 60x 5h			573,00 27,5 / 0,21
PL/6160 01311600	cm. 160x 60x 5h			603,00 29,5 / 0,22
PL/6165 01311650	cm. 165x 60x 5h			633,00 30,5 / 0,23
PL/6180 01311800	cm. 180x 60x 5h			678,00 33 / 0,24
PL/6195 01311950	cm. 195x 60x 5h			738,00 35,5 / 0,26
PL/6200 01312000	cm. 200x 60x 5h			768,00 36,5 / 0,27
PL/6210 01312100	cm. 210x 60x 5h			797,00 38,5 / 0,28
PL/6220 01312200	cm. 220x 60x 5h			828,00 40,5 / 0,30
PL/6225 01312250	cm. 225x 60x 5h			873,00 41,5 / 0,30
PL/6240 01312400	cm. 240x 60x 5h			932,00 44 / 0,32

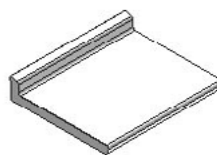

PIANI LAVORO

MOD. COD.	DESCRIZIONE/DESCRIPTION/BEZEICHNUNG/DESCRIPTION/DESCRIPCIÓN DIMENSIONI/DIMENSIONS/ABMESSUNGEN/DIMENSIONS/DIMENSIONES	POTENZA/POWER/LEISTUNG/PUISSANCE/POTENCIA VOLTAGGIO/VOLTAGE/SPANNUNG/VOLTAGE/VOLTAJE	$\frac{kW}{kcal/h}$ $\frac{V\sim}{Hz}$	PREZZO/PRICE € PREIS/PRIX/PRECIO € KG / M ³
PLA/680 01320800	PIANO LAVORO AD ANGOLO CON ALZATINA E BORDO FRONTALE ARROTONDATO EN CORNER WORKTOP WITH RAISED AND REAR BORDER • DE OBERPLATTE ECK-ELEMENT 90° MIT 75mm AUFKANTUNG HINTEN UND PROFILE ABGERUNDET. • FR PLAN DE TRAVAIL D'ANGLE AVEC JOINT DE FINITION POSTERIEUR ET BORD FRONTAL TOMBE' • ES SOBRE DE TRABAJO ANGULAR CON PETO TRASERO Y BORDE FRONTAL REDONDEADO cm.80/80x 60x 5h			599,00 18 / 0,16
BPL/645SX 01030451	BASE PER LAVELLO CON PORTA EN STORAGE UNIT FOR SINK WITH DOOR • DE FLUGELTURELEMENT FUR SPULBECKEN • FR ELEMENT DE BASE POUR EVIER AVEC PORTE • ES BASE PARA FREGADERO CON PUERTA cm. 45x 56,6x 81h			765,00 20.5 / 0,31
BPL/645DX cm. 45x 56,6x 81h 01030450				765,00 20.5 / 0,31
BPL/660 01030600	BASE PER LAVELLO CON PORTE EN STORAGE UNIT FOR SINK WITH 2 DOORS • DE FLUGELTURELEMENT FUR SPULBECKEN • FR ELEMENT DE BASE POUR EVIER AVEC 2 PORTES • ES BASE PARA FREGADERO CON PUERTAS cm. 60x 56,6x 81h			1.029,00 26 / 0,40
BPL/690 01030900	cm. 90x 56,6x 81h			1.169,00 37 / 0,57
BPL/6105 01031050	BASE PER LAVELLO CON 3 PORTE EN STORAGE UNIT FOR SINK WITH 3 DOORS • DE FLUGELTURELEMENT FUR SPULBECKEN • FR ELEMENT DE BASE POUR EVIER AVEC 3 PORTES • ES BASE PARA FREGADERO CON 3 PUERTAS cm. 105x 56,6x 81h			1.211,00 41.5 / 0,66
BPL/6120 01031200	cm. 120x 56,6x 81h			1.528,00 45 / 0,75
BPL/6135 01031350	cm. 135x 56,6x 81h			1.596,00 49.5 / 0,83
BPL/6150 01031500	cm. 150x 56,6x 81h			1.661,00 54 / 0,92

MOD. COD.	DESCRIZIONE/DESCRIPTION/BEZEICHNUNG/DESCRIPTION/DESCRIPCIÓN DIMENSIONI/DIMENSIONS/ABMESSUNGEN/DIMENSIONS/DIMENSIONES	POTENZA/POWER/LEISTUNG/PUISSANCE/POTENCIA VOLTAGGIO/VOLTAGE/SPANNUNG/VOLTAGE/VOLTAJE	⚡kW kcal/h	⚡kw V~ Hz	PREZZO/PRICE € PREIS/PRIX/PRECIO € KG / M³
BPAL/680 01130800	BASE PER LAVELLO AD ANGOLO CON PORTA EN CORNER STORAGE UNIT FOR SINK WITH DOOR • DE ECK-ELEMENT 90° FÜR ECKSPULABDECKUNG MIT FLUGELTURE • FR ELEMENT DE BASE D'ANGLE POUR EVIER AVEC PORTE • ES BASE ANGULAR PARA FREGADERO CON PUERTA cm.80/80x 56,6x 81h				1.507,00 37 / 0,70
L/645 01330450	1 VASCA cm.29x35x14h EN 1 BOWL cm.29x35x14h • DE 1 BECKEN cm.29x35x14h • FR 1 BAC cm.29x35x14h • ES 1 CUBA CM.29X35X14H cm. 45x 60x 5h				459,00 9.5 / 0,12
L/660 01330600	1 VASCA cm.34x39x19,5h EN 1 BOWL cm.34x39x19,5h • DE 1 BECKEN cm.34x39x19,5h • FR 1 BAC cm.34x39x19,5h • ES 1 CUBA CM.34X39X19,5H cm. 60x 60x 5h				565,00 12 / 0,15
L/691 SX 01330902	1 VASCA SX cm.34x39x19,5h CON SGOCCIOLATOIO EN 1 BOWL LEFT cm.34x39x19,5h WITH DRAINING BOARD • DE 1 BECKEN LINKS cm.34x39x19,5h MIT ABTROPFFLACHE • FR 1 BAC A GAUCHE cm.34x39x19,5h AVEC EGOUTTOIR • ES 1 CUBA A LA IZQ. CM.34X39X19,5H CON ESCURRIDOR cm. 90x 60x 5h				686,00 18.5 / 0,22
L/691 DX 01330901	1 VASCA DX cm.34x39x19,5h CON SGOCCIOLATOIO EN 1 BOWL RIGHT cm.34x39x19,5h WITH DRAINING BOARD • DE 1 BECKEN RECHT cm.34x39x19,5h MIT ABTROPFFLACHE • FR 1 BAC A DROITE cm.34x39x19,5h AVEC EGOUTTOIR • ES 1 CUBA A LA DERECHA CM.34X39X19,5H CON ESCURRIDOR cm. 90x 60x 5h				686,00 18.5 / 0,22
L/692 01330905	2 VASCHE cm.34x39x19,5h EN 2 BOWLS cm.34x39x19,5h • DE 2 BECKEN cm.34x39x19,5h • FR 2 BACS cm.34x39x19,5h • ES 2 CUBAS CM.34X39X19,5H cm. 90x 60x 5h				834,00 18.5 / 0,22
L/61055X 01331052	1 VASCA SX cm.34x39x19,5h CON SGOCCIOLATOIO EN 1 BOWL LEFT cm.34x39x19,5h WITH DRAINING BOARD • DE 1 BECKEN LINKS cm.34x39x19,5h MIT ABTROPFFLACHE • FR 1 BAC A GAUCHE cm.34x39x19,5h AVEC EGOUTTOIR • ES 1 CUBA A LA IZQ. CM.34X39X19,5H CON ESCURRIDOR cm. 105x 60x 5h				754,00 21,5 / 0,25

LAVELLI

MOD. COD.	DESCRIZIONE/DESCRIPTION/BEZEICHNUNG/DESCRIPTION/DESCRIPCIÓN DIMENSIONI/DIMENSIONS/ABMESSUNGEN/DIMENSIONS/DIMENSIONES	POTENZA/POWER/LEISTUNG/PUISSANCE/POTENCIA VOLTAGGIO/VOLTAGE/SPANNUNG/VOLTAGE/VOLTAJE	Ⓚw kcal/h	Ⓚw V~ Hz	PREZZO/PRICE € PREIS/PRIX/PRECIO € KG / M ³
L/6105DX 01331051	1 VASCA DX cm.34x39x19,5h CON SGOCCIOLATOIO EN 1 BOWL RIGHT cm.34x39x19,5h WITH DRAINING BOARD • DE 1 BECKEN RECHT cm.34x39x19,5h MIT ABTROPFFLACHE • FR 1 BAC A DROITE cm.34x39x19,5h AVEC EGOUTTOIR • ES 1 CUBA A LA DERECHA CM.34X39X19,5H CON ESCURRIDOR cm. 105x 60x 5h				754,00 21,5 / 0,25
L/6121SX 01331202	1 VASCA SX cm.34x39x19,5h CON SGOCCIOLATOIO EN 1 BOWL LEFT cm.34x39x19,5h WITH DRAINING BOARD • DE 1 BECKEN LINKS cm.34x39x19,5h MIT ABTROPFFLACHE • FR 1 BAC A GAUCHE cm.34x39x19,5h AVEC EGOUTTOIR • ES 1 CUBA A LA IZQ. CM.34X39X19,5H CON ESCURRIDOR cm. 120x 60x 5h				831,00 24 / 0,28
L/6121DX 01331201	1 VASCA DX cm.34x39x19,5h CON SGOCCIOLATOIO EN 1 BOWL RIGHT cm.34x39x19,5h WITH DRAINING BOARD • DE 1 BECKEN RECHT cm.34x39x19,5h MIT ABTROPFFLACHE • FR 1 BAC A DROITE cm.34x39x19,5h AVEC EGOUTTOIR • ES 1 CUBA A LA DERECHA CM.34X39X19,5H CON ESCURRIDOR cm. 120x 60x 5h				831,00 24 / 0,28
L/6122SX 01331204	2 VASCHE SX cm.34x39x19,5h CON SGOCCIOLATOIO EN 2 BOWLS LEFT cm.34x39x19,5h WITH DRAINING BOARD • DE 2 BECKEN LINKS cm.34x39x19,5h MIT ABTROPFFLACHE • FR 2 BACS A GAUCHE cm.34x39x19,5h AVEC EGOUTTOIR • ES 2 CUBAS A LA IZQ. CM.34X39X19,5H CON ESCURRIDOR cm. 120x 60x 5h				985,00 25 / 0,28
L/6122DX 01331203	2 VASCHE DX cm.34x39x19,5h CON SGOCCIOLATOIO EN 2 BOWLS RIGHT cm.34x39x19,5h WITH DRAINING BOARD • DE 2 BECKEN RECHT cm.34x39x19,5h MIT ABTROPFFLACHE • FR 2 BACS A DROITE cm.34x39x19,5h AVEC EGOUTTOIR • ES 2 CUBAS A LA DERECHA CM.34X39X19,5H CON ESCURRIDOR cm. 120x 60x 5h				985,00 25 / 0,28
L/6135SX 01331354	2 VASCHE SX cm.34x39x19,5h CON SGOCCIOLATOIO EN 2 BOWLS LEFT cm.34x39x19,5h WITH DRAINING BOARD • DE 2 BECKEN LINKS cm.34x39x19,5h MIT ABTROPFFLACHE • FR 2 BACS A GAUCHE cm.34x39x19,5h AVEC EGOUTTOIR • ES 2 CUBAS A LA IZQ. CM.34X39X19,5H CON ESCURRIDOR cm. 135x 60x 5h				1.056,00 28 / 0,32
L/6135DX 01331353	2 VASCHE DX cm.34x39x19,5h CON SGOCCIOLATOIO EN 2 BOWLS RIGHT cm.34x39x19,5h WITH DRAINING BOARD • DE 2 BECKEN RECHT cm.34x39x19,5h MIT ABTROPFFLACHE • FR 2 BACS A DROITE cm.34x39x19,5h AVEC EGOUTTOIR • ES 2 CUBAS A LA DERECHA CM.34X39X19,5H CON ESCURRIDOR cm. 135x 60x 5h				1.056,00 28 / 0,32
L/6150SX 01331504	2 VASCHE SX cm.34x39x19,5h CON SGOCCIOLATOIO EN 2 BOWLS LEFT cm.34x39x19,5h WITH DRAINING BOARD • DE 2 BECKEN LINKS cm.34x39x19,5h MIT ABTROPFFLACHE • FR 2 BACS A GAUCHE cm.34x39x19,5h AVEC EGOUTTOIR • ES 2 CUBAS A LA IZQ. CM.34X39X19,5H CON ESCURRIDOR cm. 150x 60x 5h				1.138,00 30.5 / 0,35

MOD. COD.	DESCRIZIONE/DESCRIPTION/BEZEICHNUNG/DESCRIPTION/DESCRIPCIÓN DIMENSIONI/DIMENSIONS/ABMESSUNGEN/DIMENSIONS/DIMENSIONES	POTENZA/POWER/LEISTUNG/PUISSANCE/POTENCIA VOLTAGGIO/VOLTAGE/SPANNUNG/VOLTAGE/VOLTAGE	⚡kW kcal/h	⚡kw V~ Hz	PREZZO/PRICE PREIS/PRIX/PRECIO € KG / M ³
L/6150DX 01331503	2 VASCHE DX cm.34x39x19,5h CON SGOCCIOLATOIO EN 2 BOWLS RIGHT cm.34x39x19,5h WITH DRAINING BOARD • DE 2 BECKEN RECHT cm.34x39x19,5h MIT ABTROPFFLACHE • FR 2 BACS A DROITE cm.34x39x19,5h AVEC EGOUTTOIR • ES 2 CUBAS A LA DERECHA CM.34X39X19,5H CON ESCURRIDOR cm. 150x 60x 5h				1.138,00 30.5 / 0,35
LA/680 01340800	1 VASCA cm.50x40x20h EN 1 BOWL cm.50x40x20h • DE 1 BECKEN cm.50x40x20h • FR 1 BAC cm.50x40x20h • ES 1 CUBA CM.50X40X20H cm.80/80x 60x 5h				959,00 19 / 0,26
PP/630SX 01210301	PENSILE CON PORTA E RIPIANO INTERMEDIO EN WALL UNIT WITH DOOR , AND MIDDLE SHELF • DE WANDHANGESCHRANK MIT TUR , UND ZWISCHENBORD • FR ARMOIRE SUSPENDUE AVEC PORTE ET ETAGERE INTERMEDIAIRE • ES ARMARIO DE PARED CON PUERTA Y ESTANTE INTERMEDIO cm. 30x 40x 69h				742,00 16 / 0,17
PP/640SX 01210401	cm. 40x 40x 69h				765,00 19 / 0,21
PP/645SX 01210451	cm. 45x 40x 69h				787,00 20.5 / 0,23
PP/650SX 01210501	cm. 50x 40x 69h				810,00 22 / 0,25
PP/630DX 01210300	cm. 30x 40x 69h				742,00 16 / 0,17
PP/640DX 01210400	cm. 40x 40x 69h				765,00 19 / 0,21
PP/645DX 01210450	cm. 45x 40x 69h				787,00 20.5 / 0,23
PP/650DX 01210500	cm. 50x 40x 69h				810,00 22 / 0,25
PP/660 01210600	PENSILE CON PORTE, GUARNIZIONE E RIPIANO INTERMEDIO EN WALL UNIT WITH DOORS , GASKET AND MIDDLE SHELF • DE WANDHANGESCHRANK MIT TUREN , TURDICHTUNGEN UND ZWISCHENBORD • FR ARMOIRE SUSPENDUE AVEC PORTES, JOINT DE PORTE ET ETAGERE INTERMEDIAIRE • ES ARMARIO DE PARED CON PUERTAS, GUARNICION Y ESTANTE INTERMEDIO cm. 60x 40x 69h				1.017,00 26 / 0,30
PP/670 01210700	cm. 70x 40x 69h				1.057,00 29 / 0,34
PP/680 01210800	cm. 80x 40x 69h				1.099,00 33 / 0,38
PP/690 01210900	cm. 90x 40x 69h				1.162,00 36 / 0,43
PP/6100 01211000	cm. 100x 40x 69h				1.207,00 39 / 0,47

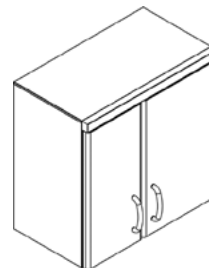
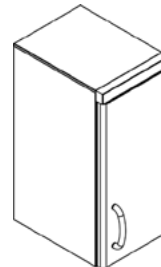
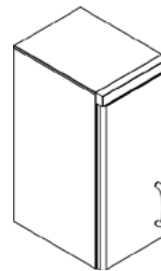
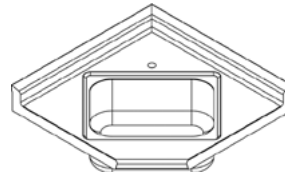
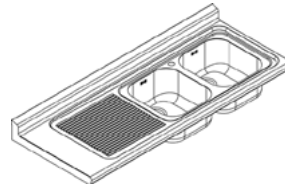

PENSILI

MOD. COD.	DESCRIZIONE/DESCRIPTION/BEZEICHNUNG/DESCRIPTION/DESCRIPCIÓN DIMENSIONI/DIMENSIONS/ABMESSUNGEN/DIMENSIONS/DIMENSIONES	POTENZA/POWER/LEISTUNG/PUISSANCE/POTENCIA VOLTAGGIO/VOLTAGE/SPANNUNG/VOLTAGE/VOLTAJE	kw kcal/h	kw V~ Hz	PREZZO/PRICE PREIS/PRIX/PRECIO € KG / M³
PP/6105 01211050	PENSILE CON 3 PORTE, GUARNIZIONI E RIPIANO INTERMEDIO EN WALL UNIT WITH 3 DOORS , GASKET AND MIDDLE SHELF • DE WANDHANGESCHRANK MIT 3 TÜREN , TURDICHTUNGEN UND ZWISCHENBORD • FR ARMOIRE SUSPENDUE AVEC 3 PORTES, JOINT DE PORTE ET ETAGERE INTERMEDIAIRE • ES ARMARIO DE PARED CON 3 PUERTAS, GUARNICION Y ESTANTE INTERMEDIO cm. 105x 40x 69h				1.448,00 40.5 / 0,49
PP/6110 01211100	cm. 110x 40x 69h				1.474,00 42 / 0,51
PP/6120 01211200	cm. 120x 40x 69h				1.518,00 45 / 0,56
PP/6125 01211250	cm. 125x 40x 69h				1.543,00 46.5 / 0,58
PP/6135 01211350	cm. 135x 40x 69h				1.628,00 49.5 / 0,62
PP/6150 01211500	cm. 150x 40x 69h				1.715,00 53 / 0,69
PPS/660 01230600	PENSILE SCOLAPIATTI CON PORTE, GUARNIZIONE E PORTAPIATTI EN WALL UNIT PLATE RACK WITH DOORS, GASKETS AND PLATE RACK • DE WANDHANGESCHRANK FÜR TELLER MIT FLUGELTÜREN UND TURDICHTUNGEN • FR ARMOIRE EGOUTTOIR SUSPENDUE AVEC PORTES JOINTS DE PORTE, GRILLE INTERMEDIAIRE PORTE-ASSIETTES • ES ARMARIO DE PARED ESCURRIDOR CON PUERTA Y GUARNICION cm. 60x 40x 69h				1.274,00 26 / 0,30
PPS/690 01230900	cm. 90x 40x 69h				1.396,00 34 / 0,43
PPA/680 01260801	PENSILE AD ANGOLO CON PORTA E RIPIANO INTERMEDIO EN CORNER WALL UNIT WITH DOOR AND MIDDLE SHELF • DE ECK-WANDHANGESCHRANK MIT FLUGELTÜRE UND ZWISCHENBORD • FR ARMOIRE D'ANGLE SUSPENDUE AVEC 2 PORTES ET ETAGERE INTERMEDIAIRE • ES ARMARIO ANGULAR DE PARED CON PUERTA Y ESTANTE INTERMEDIO cm.80/80x 40x 69h				1.697,00 38 / 0,70
PPV/630SX 01220301	PENSILE CON PORTA VETRO E RIPIANO INTERMEDIO EN WALL UNIT WITH GLASS DOOR AND MIDDLE SHELF • DE WANDHANGESCHRANK MIT GLASTÜR UND ZWISCHENBORD • FR ARMOIRE SUSPENDUE AVEC PORTE VITREE ET ETAGERE INTERMEDIAIRE • ES ARMARIO DE PARED CON PUERTA VIDRIERA Y ESTANTE INTERMEDIO cm. 30x 40x 69h				821,00 16.5 / 0,17
PPV/645SX 01220451	cm. 45x 40x 69h				903,00 21 / 0,23

MOD. _____ DESCRIZIONE/DESCRIPTION/BEZEICHNUNG/DESCRIPTION/DESCRIPCIÓN POTENZA/POWER/LEISTUNG/PUISSANCE/POTENCIA $\frac{\text{kW}}{\text{kcal/h}}$ $\frac{\text{kw}}{\text{V-}}$ PREZZO/PRICE €
 COD. _____ DIMENSIONI/DIMENSIONS/ABMESSUNGEN/DIMENSIONS/DIMENSIONES VOLTAGGIO/VOLTAGE/SPANNUNG/VOLTAGE/VOLTAGE $\frac{\text{V-}}{\text{Hz}}$ PREIS/PRIX/PRECIO €
 KG / M³

PPV/630DX cm. 30x 40x 69h
 01220300

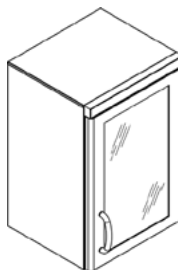

821,00
 16.5 / 0,17

PPV/645DX cm. 45x 40x 69h
 01220450

903,00
 21 / 0,23

PPV/660 PENSILE CON PORTE VETRO, GUARNIZIONE E RIPIANO INTERMEDIO
 01220600 **EN** WALL UNIT WITH GLASS DOORS, GASKET AND MIDDLE SHELF
 • **DE** WANDHANGESCHRANK MIT 2 GLASTURE, TURDICHTUNG UND ZWISCHENBORD • **FR** ARMOIRE SUSPENDUE AVEC 2 PORTES VITREE , JOINT DE PORTE ET ETAGERE INTERMEDIAIRE • **ES ARMARIO DE PARED CON PUERTAS VIDRIERA, GUARNICION Y ESTANTE INTERMEDIO**

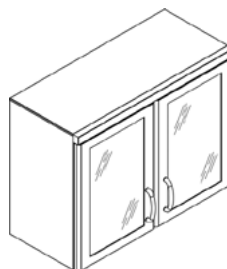

1.156,00
 27 / 0,30

cm. 60x 40x 69h

PPV/690 cm. 90x 40x 69h
 01220900

1.381,00
 37 / 0,43

PPV/6105 PENSILE CON 3 PORTE VETRO, GUARNIZIONI E RIPIANO INTERMEDIO
 01221050 **EN** WALL UNIT WITH 3 GLASS DOORS, GASKETS AND MIDDLE SHELF
 • **DE** WANDHANGESCHRANK MIT 3 GLASTURE, TURDICHTUNG UND ZWISCHENBORD • **FR** ARMOIRE SUSPENDUE AVEC 3 PORTES VITREE , JOINT DE PORTE ET ETAGERE INTERMEDIAIRE • **ES ARMARIO DE PARED CON 3 PUERTAS VIDRIERA, GUARNICION Y ESTANTE INTERMEDIO**

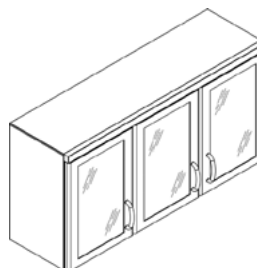

1.696,00
 42 / 0,49

cm. 105x 40x 69h

PPV/6135 cm. 135x 40x 69h
 01221350

1.954,00
 51 / 0,62

A/660 ARMADIO CON PORTE, GUARNIZIONI E 4 RIPIANI INTERMEDI
 01160600 **EN** TWIN UNIT WITH DOORS, GASKET AND 4 MIDDLE SHELVES
 • **DE** HOCHSCHRANK MIT TUREN, TURDICHTUNGEN UND 4 ZWISCHENBORDE • **FR** ARMOIRE A PORTES, JOINT DE PORTE ET 4 ETAGERES INTERMEDIAIRES • **ES ARMARIO CON PUERTAS, GUARNICIONES Y 4 ESTANTES INTERMEDIOS**



2.587,00
 70 / 1,07

cm. 60x 60x 220h

A/690 cm. 90x 60x 220h
 01160900

3.105,00
 99 / 1,52

AV/660 ARMADIO CON PORTE VETRO, GUARNIZIONI E 4 RIPIANI INTERMEDI
 01170600 **EN** TWIN UNIT WITH GLASS DOORS, GASKETS AND 4 MIDDLE SHELVES • **DE** HOCHSCHRANK MIT 4 GLASTUREN, TURDICHTUNGEN UND 4 ZWISCHENBORDE • **FR** ARMOIRE AVEC PORTES VITREE, JOINTES DE PORTE ET 4 ETAGERES INTERMEDIAIRES • **ES ARMARIO CON PUERTAS VIDRIERA, GUARNICIONES Y 4 ESTANTES INTERMEDIOS**

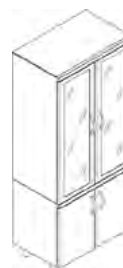

2.796,00
 73 / 1,07

cm. 60x 60x 220h

AV/690 cm. 90x 60x 220h
 01170900

3.321,00
 102 / 1,52

CAPPE

MOD. COD.	DESCRIZIONE/DESCRIPTION/BEZEICHNUNG/DESCRIPTION/DESCRIPCIÓN DIMENSIONI/DIMENSIONS/ABMESSUNGEN/DIMENSIONS/DIMENSIONES	POTENZA/POWER/LEISTUNG/PUISSANCE/POTENCIA VOLTAGGIO/VOLTAGE/SPANNUNG/VOLTAGE/VOLTAJE	⚡ kcal/h kw V~ Hz	PREZZO/PRICE € PREIS/PRIX/PRECIO € KG / M³
KSK/660 01280600	CAPPA STILE CON PARETE E MENSOLA, ASPIRAZIONE AUTOFILTRANTE E CARBONI ATTIVI, 2 VELOCITA' E LUCE EN SELF-FILTER EXTRACTOR HOOD WITH WALL AND BRACKET, ACTIVATED CHARCOAL, 2 SPEED MOTOR AND LIGHT. • DE SELBSTFILTRIERENDE ABZUGSHAUBE MIT KOHLEAKTIVFILTERN, 2-STUFEN GEBLASE, BELEUCHTUNG, WANDVERKLEIDUNG UND KONSOLE. • FR HOTTE D'ASPIRATION DE STYLE AUTOFILTRANTE, AU CHARBON ACTIF, MOTEUR 2 VITESSES, LUMIERE, PAROIR ET ATAGERE • ES CAMPANA EXTRACTORA CON PARED Y REPISA, CON ASPIRACION AUTOFILTRANTE Y CARBONES ACTIVOS, 2 VELOCIDADES Y LUZ. cm. 60x 60x 70h		⚡ 0,22 KW 230V~ 50 Hz	1.604,00 23 / 0,41
KSK/690 01280900	cm. 90x 60x 70h		⚡ 0,22 KW 230V~ 50 Hz	1.865,00 32 / 0,60
KSK/6100 01281000	cm. 100x 60x 70h		⚡ 0,22 KW 230V~ 50 Hz	2.162,00 33 / 0,67
SP/630 01400300	SCHIENA SOTTO PENSILI EN SPLASH BACK FOR WALL UNIT • DE RUCKWAND FÜR HOCHSCHRANK • FR FINITION DOS POUR ARMOIRES SUSPENDUE • ES ESPALDA DEBAJO DE ARMADIO DE PARED cm. 30x 0,2x 62,5h			85,00 1.3 / 0,00
SP/640 01400400	cm. 40x 0,2x 62,5h			112,00 1.8 / 0,01
SP/645 01400450	cm. 45x 0,2x 62,5h			127,00 2 / 0,01
SP/650 01400500	cm. 50x 0,2x 62,5h			139,00 2.2 / 0,01
SP/670 01400700	cm. 70x 0,2x 62,5h			179,00 3.1 / 0,01
SP-SK/680 01400800	cm. 80x 0,2x 80h			204,00 4.5 / 0,01
SP/6105 01401050	cm. 105x 0,2x 62,5h			266,00 4.6 / 0,01
SP/6110 01401100	cm. 110x 0,2x 62,5h			278,00 4.8 / 0,02
SP-SK/6120 01401200	cm. 120x 0,2x 80h			302,00 6.7 / 0,02
SP/6125 01401250	cm. 125x 0,2x 62,5h			316,00 5.5 / 0,02
SP/6135 01401350	cm. 135x 0,2x 62,5h			342,00 5.9 / 0,02
SP-SK/6150 01401500	cm. 150x 0,2x 80h			379,00 8.4 / 0,03

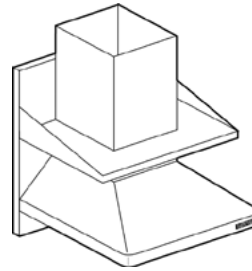

ACCESSORI

MOD. _____ DESCRIZIONE/DESCRIPTION/BEZEICHNUNG/DESCRIPTION/DESCRIPCIÓN POTENZA/POWER/LEISTUNG/PUISSANCE/POTENCIA ⚡kw ⚡kw PREZZO/PRICE €
 COD. _____ DIMENSIONI/DIMENSIONS/ABMESSUNGEN/DIMENSIONS/DIMENSIONES VOLTAGGIO/VOLTAGE/SPANNUNG/VOLTAGE/VOLTAGE V-kcal/h V- kw PREIS/PRIX/PRECIO €
 KG / M³

SP-SK/660 SCHIENA SOTTO PENSILI E CAPPE KSK **152,00**
 01400600 **EN** SPLASH BACK FOR WALL UNIT AND HOOD KSK • **DE** RUCKWAND FUR HOCHSCHRANK UND HAUBE KSK • **FR** FINITION DOS POUR ARMOIRES SUSPENDUE ET HOTTE KSK • **ES** ESPALDA DEBAJO DE ARMADIO DE PARED Y CAMPANA KSK **3.4 / 0,01**
cm. 60x 0,2x 80h



SP-SK/690 **cm. 90x 0,2x 80h** **226,00**
 01400900 **5 / 0,02**

SP-SK/6100 **cm. 100x 0,2x 80h** **253,00**
 01401000 **5.6 / 0,02**

ZB ZOCCOLATURA BASE **154,00**
 01410000 **EN** FRONT PLINTH • **DE** GRUNDSOCKEL • **FR** PLINTHE FRONTAL • **ES** ZOCCOLOS BASE **/**
€/m x cm. 15h

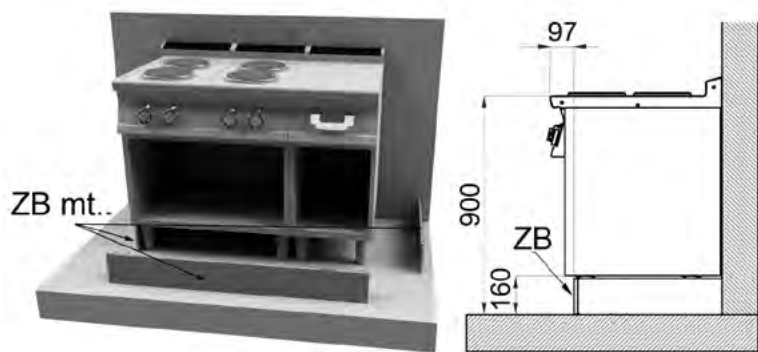

ZA ZOCCOLATURA ANGOLO **93,00**
 01410002 **EN** CORNER PLINTH • **DE** EKE-SOCKEL • **FR** PLINTHE ANGLE • **ES** ZOCCOLOS ANGULAR **0.3 / 0,01**
cm. 15h

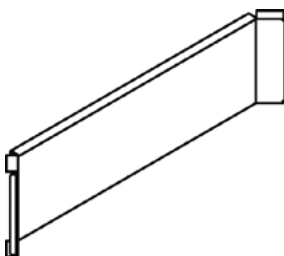

PC PP/630 PROTEZIONE CAVO FARETTO **24,00**
 01430300 **EN** CABLE PROTECTION OF SMALL LAMP • **DE** SCHUTZKABEL VOM SCHEINWERFER • **FR** PROTECTION CABLE POUR LAMP • **ES** PROTECCION CABLE PUNTO DE LUZ **/ 0,00**
cm. 30x 1,2x 2,9h

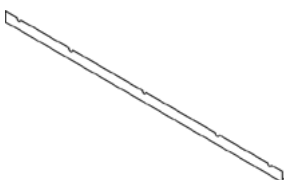

PC PP/640 **cm. 40x 1,2x 2,9h** **29,00**
 01430400 **/ 0,00**

PC PP/645 **cm. 45x 1,2x 2,9h** **32,00**
 01430450 **/ 0,00**

PC PP/650 **cm. 50x 1,2x 2,9h** **35,00**
 01430500 **/ 0,00**

PC PP/660 **cm. 60x 1,2x 2,9h** **45,00**
 01430600 **/ 0,00**

PC PP/670 **cm. 70x 1,2x 2,9h** **49,00**
 01430700 **/ 0,00**

ACCESSORI

MOD. COD.	DESCRIZIONE/DESCRIPTION/BEZEICHNUNG/DESCRIPTION/DESCRIPCIÓN DIMENSIONI/DIMENSIONS/ABMESSUNGEN/DIMENSIONS/DIMENSIONES	POTENZA/POWER/LEISTUNG/PUISSANCE/POTENCIA VOLTAGGIO/VOLTAGE/SPANNUNG/VOLTAGE/VOLTAJE	kw kcal/h	kw V~ Hz	PREZZO/PRICE PREIS/PRIX/PRECIO €/M ³
PC PP/680 01430800	cm. 80x 1,2x 2,9h				57,00 / 0,00
PC PP/690 01430900	cm. 90x 1,2x 2,9h				60,00 / 0,00
PC PP/6100 01431000	cm. 100x 1,2x 2,9h				64,00 / 0,00
PC PP/6105 01431050	cm. 105x 1,2x 2,9h				73,00 / 0,00
PC PP/6110 01431100	cm. 110x 1,2x 2,9h				77,00 / 0,00
PC PP/6120 01431200	cm. 120x 1,2x 2,9h				90,00 / 0,00
PC PP/6125 01431250	cm. 125x 1,2x 2,9h				97,00 / 0,00
PC PP/6135 01431350	cm. 135x 1,2x 2,9h				106,00 / 0,00
PC PP/6150 01431500	cm. 150x 1,2x 2,9h				114,00 / 0,00
KIT FARETTO 01420000	KIT FARETTO LED 1,3W L2000 (FARETTO,GHIERA,STAFFA) EN KIT SMALL LAMP LED 1,3W L2000 • DE KIT SCHEINWERFER LED 1,3W L2000 • FR KIT LAMPE LED 1,3W L2000 • ES PUNTO DE LUZ LED 1,3W L2000		0,001 KW	12V~ 50/60 Hz	170,00 / 0,00
TRASFORMATORE 01420001	TRASFORMATORE 230V-12V MAX 6 INGRESSI LED EN TRANSFORMER 230V-12V MAX 6 LED • DE VERWANDLER 230V-12V MAX 6 LED • FR TRASFORMATEUR 230V-12V MAX 6 LED • ES TRANSFORMADOR DE CORRIENTE 230V-12V MAX 6 LED				93,00 / 0,00
PROLUNGA BT 01420002	PROLUNGA 12V L1500 EN EXTENSION 12V-L1500 • DE FORTSATZT 12V L1500 • FR RALLONGE 12V L1500 • ES EXTENSIÓN 12V L1500				52,00 / 1,00
EROS4 _EROS004	GRUPPO RUBINETTO DOCCIA A LEVA EN TAP FOR SINK WITH SHOWER • DE MISCHBATTERIE • FR GROUPE ROBINET AVEC DOUCHE • ES GRUPO GRIFO CON DUCHA cm. 27x 45h				265,00 2 / 0,01

ACCESSORI

MOD. COD.	DESCRIZIONE/DESCRIPTION/BEZEICHNUNG/DESCRIPTION/DESCRIPCIÓN DIMENSIONI/DIMENSIONS/ABMESSUNGEN/DIMENSIONS/DIMENSIONES	POTENZA/POWER/LEISTUNG/PUISSANCE/POTENCIA VOLTAGGIO/VOLTAGE/SPANNUNG/VOLTAGE/VOLTAJE	$\frac{\text{kW}}{\text{kcal/h}}$ $\frac{\text{kw}}{\text{V-}}$ Hz	PREZZO/PRICE € PREIS/PRIX/PRECIO KG / M ³
---------------------	---	---	---	---

GL
51262000

GRUPPO RUBINETTO A LEVA, A NORME IGENICHE
EN LEVER TAP FOR SINK IN ACCORDANCE WITH SANITARY
 REGULATIONS • **DE** EINHEBEL-MISCHBATTERIE • **FR** GROUPE
 ROBINET A LEVIER, AUX NORMES HYGIENIQUES • **ES GRUPO**
GRIFO CON PALANCA SEGUN NORMAS HIGIENICAS
 cm. 21x 24h



117,00
1 / 0,00

SER
01440000

KIT SERRATURA CON CHIAVE PER PORTA
EN KIT LOCK WITH KEYS FOR DOOR • **DE** KIT SCHLOSS KT
 SCHLUSSEL FUR TUR • **FR** SERRURE AVEC CLES POUR PORTE • **ES**
CERRADURA CON LLAVE PARA PUERTA



64,00
/

65

LOTUS®

BAGNOMARIA ELETTRICI

MOD. _____
COD. _____

DESCRIZIONE/DESCRIPTION/BEZEICHNUNG/DESCRIPTION/DESCRIPCIÓN
DIMENSIONI/DIMENSIONS/ABMESSUNGEN/DIMENSIONS/DIMENSIONES

POTENZA/POWER/LEISTUNG/PUISSANCE/POTENCIA
VOLTAGGIO/VOLTAGE/SPANNUNG/VOLTAGE/VOLTAJE

⚡ kW _____
kcal/h _____
230V~ _____
50/60 Hz

PREZZO/PRICE € _____
PREIS/PRIX/PRECIO € _____
KG / M³

BM-4EM
07050410

BAGNOMARIA MONOFASE Vasca per GN 1/1 h.15
EN Bain marie singlephase - Bowl for GN 1/1 h.15 • **DE** Wasserbäder einphasig - Becken GN 1/1 h.15 • **FR** Bain marie monophasé - Cuve GN 1/1 h.15 • **ES BAÑO DE MARÍA MONOFÁSICO - CUBA PARA GN 1/1 15H**
cm. 40x 65x 29h



⚡ 2,1 kW _____ **1.209,00**
230V~ _____ 21 / 0,18
50/60 Hz

BM-6EM
07050610

BAGNOMARIA MONOFASE Vasca per 1 GN 1/1 + 2 GN 1/4 h.15
EN Bain marie singlephase - Bowl for 1 GN 1/1 + 2 GN 1/4 h.15
• **DE** Wasserbäder einphasig - Becken für 1 GN 1/1 + 2 GN 1/4 h.15
• **FR** Bain-marie monophasé - Cuve pour 1 GN 1/1 + 2 GN 1/4 h.15
• **ES BAÑO DE MARÍA MONOFÁSICO - CUBA PARA 1 GN 1/1 + 2 GN 1/4 15H**
cm. 60x 65x 29h

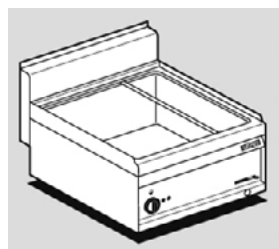

⚡ 3,15 kW _____ **1.467,00**
230V~ _____ 27 / 0,27
50/60 Hz

BM-4G
07220450

BAGNOMARIA GAS - Vasca per GN 1/1 h.15
EN Gas bain-marie - Bowl for GN 1/1 h.15 • **DE** Gas Wasserbad - Becken für GN 1/1 h.15 • **FR** Bain-marie gaz - Cuve pour GN 1/1 h.15
• **ES BAÑO DE MARÍA GAS - CUBA PARA GN 1/1 H.15**
cm. 40x 65x 29h



⚡ 3,5 kW _____ **1.556,00**
3.010 kcal/h _____ 27 / 0,18

BM-6G
07220650

BAGNOMARIA GAS Vasca per GN 1/1 + 2 GN 1/4, h.15
EN Gas bain-marie - Bowl for GN 1/1 + 2 GN 1/4, h.15 • **DE** Gas Wasserbad - Becken für GN 1/1 + 2 GN 1/4, h.15 • **FR** Bain-marie gaz - Cuve pour GN 1/1 + 2 GN 1/4, h.15 • **ES BAÑO DE MARÍA GAS - CUBA PARA GN 1/1 + 2 GN 1/4, H.15**
cm. 60x 65x 29h



⚡ 5 kW _____ **2.010,00**
4.300 kcal/h _____ 33 / 0,27

BS-4EM
07040410

CONTENITORE CALDO MONOFASE Vasca cm. 30,5x51x16,5h con falsofondo forato.
EN Fry dump singlephase Bowl cm. 30,5x51x16,5h with perforated bottom. • **DE** Frittenwanne einphasig Becke cm. 30,5x51x16,5h mit gelochtem Bodenrost. • **FR** Silo à frites monophasé Cuve cm 30,5x51x16,5h avec double-fond perforé • **ES RECIPIENTE CALIENTE MONOFÁSICO CUBA CM. 30,5X51X16,5H CON FALSO FONDO AGUJERADO**
cm. 40x 65x 29h



⚡ 0,82 kW _____ **1.126,00**
230V~ _____ 21.5 / 0,18
50/60 Hz

RI-4EM
07040411

RISCALDANTE INFRAROSSO MONOFASE
EN Infra-red heater singlephase • **DE** Infrarot-Strahler einphasig • **FR** Lampe chauffante à infrarouge monophasé • **ES CALENTADOR INFRARROJO MONOFÁSICO**
cm. 39x 50x 37h



⚡ 0,33 kW _____ **829,00**
230V~ _____ 8 / 0,10
50/60 Hz

PIANI COTTURA ELETTRICI

MOD. _____ DESCRIZIONE/DESCRIPTION/BEZEICHNUNG/DESCRIPTION/DESCRIPCIÓN POTENZA/POWER/LEISTUNG/PUISSANCE/POTENCIA ⚡ kW ⚡ kw PREZZO/PRICE €
 COD. _____ DIMENSIONI/DIMENSIONS/ABMESSUNGEN/DIMENSIONS/VOLTAGGIO/VOLTAGE/SPANNUNG/VOLTAGE/VOLTAJE kcal/h V~ Hz PREIS/PRIX/PRECIO KG / M³

PC-4ET
 07030430
 PIANO COTTURA TRIFASE N. 2 piastre
EN Boiling unit - N. 2 plates • **DE** Kochplatte - N. 2 Kochplatten
 • **FR** Rechaud - N. 2 plaques • **ES SOBRE DE COCCIÓN - N. 2 PLANCHAS**
cm. 40x 65x 29h



⚡ 4 kW **915,00**
 400V~2N 25.5 / 0,18
 230V~3
 230V~
 50/60 Hz

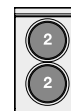

PC-6ET
 07030630
 PIANO COTTURA TRIFASE N. 4 piastre
EN Boiling unit - N. 4 plates • **DE** Kochplatte - N. 4 Kochplatten
 • **FR** Rechaud - N. 4 plaques • **ES SOBRE DE COCCIÓN - N. 4 PLANCHAS**
cm. 60x 65x 29h



⚡ 7,5 kW **1.641,00**
 400V~3N 37 / 0,27
 230V~3
 230V~
 50/60 Hz

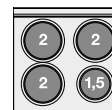

PC-4G
 07210450
 PIANO COTTURA GAS 2 fuochi
EN Gas heated boiling unit - 2 burners • **DE** Gas-Kochplatte - 2 Kochstellen • **FR** Rechaud gaz - 2 Feux vifs • **ES SOBRES DE COCCIÓN GAS - 2 QUÉMADORES**
cm. 40x 65x 29h



⚡ 9 kW **1.326,00**
 7.740 kcal/h 44 / 0,18

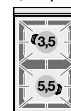

PC-8G
 07210850
 PIANO COTTURA GAS 4 fuochi
EN Gas heated boiling unit - 4 burners • **DE** Gas-Kochplatte - 4 Kochstellen • **FR** Rechaud gaz - 4 Feux vifs • **ES SOBRES DE COCCIÓN GAS - 4 QUÉMADORES**
cm. 80x 65x 29h



⚡ 18 kW **2.036,00**
 15.480 kcal/h 60.5 / 0,35

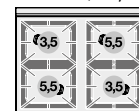

PCC-4ET
 07110430
 PIANO COTTURA VETROCERAMICA TRIFASE 2 piastre - Vetro: cm. 36x52
EN Boiling unit ceramic glass threephase, 2 plates. Glass: cm. 36x52
 • **DE** Kochplatte ceran-kochfläche dreiphasig, 2 Kochplatten. Kochfläche: cm. 36x52 • **FR** Rechaud triphase vitroceramique, 2 foyers. Vitre: cm. 36x52 • **ES SOBRES DE COCCIÓN VITROCERÁMICA TRIFÁSICO, 2 PLANCHAS. VIDRIO: 36X52 CM**
cm. 40x 65x 29h



⚡ 3,6 kW **2.097,00**
 400V~2N 23.5 / 0,18
 230V~3
 230V~
 50/60 Hz

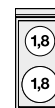

PIANI COTTURA ELETTRICI

MOD. _____
COD. _____

DESCRIZIONE/DESCRIPTION/BEZEICHNUNG/DESCRIPTION/DESCRIPCIÓN
DIMENSIONI/DIMENSIONS/ABMESSUNGEN/DIMENSIONS/DIMENSIONES

POTENZA/POWER/LEISTUNG/PUISSANCE/POTENCIA
VOLTAGGIO/VOLTAGE/SPANNUNG/VOLTAGE/VOLTAGE

⚡ kW _____
kcal/h _____
V~ _____
Hz _____

PREZZO/PRICE €
PREIS/PRIX/PRECIO _____
KG / M³

PCC-6ET
07110630

PIANO COTTURA VETROCERAMICA TRIFASE 4 piastre - Vetro: cm. 56x52
EN Boiling unit ceramic glass threephase, 4 plates. Glass: cm. 56x52
• **DE** Kochplatte Ceran-Kochfläche dreiphasig, 4 Kochplatten.
Kochfläche: cm. 56x52 • **FR** Rechaud triphase vitrocéramique, 4 foyers.
Vitro: cm. 56x52 • **ES SOBRES DE COCCIÓN VITROCERÁMICA TRIFÁSICO, 4 PLANCHAS. VIDRIO: 56X52 CM cm. 60x 65x 29h**



⚡ 7,2 kW
400V~3N
230V~3
230V~
50/60 Hz

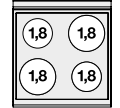

3.168,00
32 / 0,27

BR-6ET
07070630

BRASIERA TRIFASE - lt. 20 - Vasca cm. 50,5x41x10h
EN Bratt-pan threephase - Cap. 20 litres - Pan cm. 50,5x41x10h
• **DE** Bratpfanne dreiphasig lt. 20 - Becken cm. 50,5x41x10h • **FR** Sauteuse triphase capacité 20 lt. Cuve cm. 50,5x41x10h • **ES SARTÉN TRIFÁSICA 20 LT. - CUBA CM. 50,5X41X10H cm. 60x 65x 29h**



⚡ 6 kW
400V~3N
230V~3
50/60 Hz

2.034,00
47 / 0,27

BR-6G
07240650

BRASIERA GAS lt. 20 - Vasca cm. 50,5x41x10h
EN Gas bratt-pan - Capacity 20 litres - Pan cm. 50,5x41x10 h • **DE** Gas Bratpfanne - lt. 20 - Becken cm. 50,5x41x10 h • **FR** Sauteuse gaz - lt. 20 - Bac cm. 50,5x41x10h • **ES SARTÉN GAS - 20 L. - CUBA CM. 50,5X41X10H cm. 60x 65x 29h**



⚡ 6,9 kW
5.930 kcal/h

2.642,00
46 / 0,27

CF4-8ET
07660830

CUCINA ELETTRICA CON 4 PIASTRE Forno elettrico multifunzione camera cm. 64x37x35h, temp: 50÷250°C, con 1 griglia cm.53x32,5 GN1/1 - Porta vetro
EN Range N. 4 plates Multifunction electric oven Chamber cm. 64x37x35h, temp: 50÷250°C, with 1 grid cm.53x32,5 GN1/1 - Glass door • **DE** Elektroherd N. 4 Kochplatten Multifunktions-Elektroofen cm. 64x37x35h, temp: 50÷250°C, with 1 grid cm.53x32,5 GN1/1 - Glastür • **FR** Cuisinière - N. 4 plaques Four électrique à fonctions multiples cm. 64x37x35h, temp: 50÷250°C, avec 1 grille cm.53x32,5 GN1/1 - Porte vitrée • **ES COCINA N. 4 PLANCHAS HORNO ELÉCTRICO MULTIFUNCIONAL - CÁMARA CM. 64X37X35H, TEMP: 50÷250 °C, CON 1 PARILLA CM.53X32,5 GN1/1 - PUERTA VIDRIO cm. 80x 65x 87h**



⚡ 11,11 kW
400V~3N
230V~3
50/60 Hz

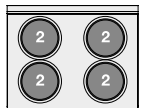

3.810,00
95 / 0,78

CF4-8ET
07660831

CUCINA ELETTRICA CON 4 PIASTRE Forno elettrico multifunzione camera cm. 64x37x35h, temp: 50÷250°C, con 1 griglia cm.53x32,5 GN1/1 - Porta cieca inox
EN Range N. 4 plates Multifunction electric oven Chamber cm. 64x37x35h, temp: 50÷250°C, with 1 grid cm.53x32,5 GN1/1 - Stainless steel door • **DE** Elektroherd N. 4 Kochplatten Multifunktions-Elektroofen cm. 64x37x35h, temp: 50÷250°C, with 1 grid cm.53x32,5 GN1/1 - Edelstahltür • **FR** Cuisinière - N. 4 plaques Four électrique à fonctions multiples cm. 64x37x35h, temp: 50÷250°C, avec 1 grille cm.53x32,5 GN1/1 - Porte acier inoxydable • **ES COCINA N. 4 PLANCHAS HORNO ELÉCTRICO MULTIFUNCIONAL - CÁMARA CM. 64X37X35H, TEMP: 50÷250 °C, CON 1 PARILLA CM.53X32,5 GN1/1 - PUERTA CIEGA INOX cm. 80x 65x 87h**



⚡ 11,11 kW
400V~3N
230V~3
50/60 Hz

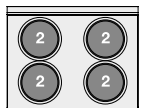

3.810,00
95 / 0,78

CUCINE ELETTRICHE

MOD. _____
COD. _____

DESCRIZIONE/DESCRIPTION/BEZEICHNUNG/DESCRIPTION/DESCRIPCIÓN
DIMENSIONI/DIMENSIONS/ABMESSUNGEN/DIMENSIONS/DIMENSIONES

POTENZA/POWER/LEISTUNG/PUISSANCE/POTENCIA
VOLTAGGIO/VOLTAGE/SPANNUNG/VOLTAGE/VOLTAJE

⚡ kW kcal/h
⚡ kw V~ Hz

PREZZO/PRICE €
PREIS/PRIX/PRECIO €
KG / M³

CF4-8ETS
07660832

Cucina elettrica con N. 4 piastre - Forno elettrico statico c/grill cm. 64x42x35h, temp: 50÷250°C, con 1 griglia cm.53x32,5 GN1/1 - Porta vetro
EN Range N. 4 plates - Static oven with grill cm. 64x42x35h, temp: 50÷250°C, with 1 grid cm.53x32,5 GN1/1 - Glass door • **DE** Elektroherd N. 4 Kochplatten Statischer Ofen mit Grill cm. 64x42x35h, temp: 50÷250°C, with 1 grid cm.53x32,5 GN1/1 - Glastür • **FR** Cuisinière N. 4 plaques - Four statique avec grill cm. 64x42x35h, temp: 50÷250°C, mit 1 Rost cm.53x32,5 GN1/1 - Porte vitrée • **ES COCINA N. 4 PLANCHAS - HORNO ESTÁTICO CON ASADOR CM. 64X42X35H, TEMP: 50÷250 °C, CON 1 PARILLA CM.53X32,5 GN1/1 - PUERTA VIDRIO cm. 80x 65x 87h**



⚡ 10,62 KW 3.335,00
400V~3N 95 / 0,78
230V~3
50/60 Hz

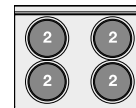

CF4-8ETS
07660833

Cucina elettrica con N. 4 piastre - Forno elettrico statico c/grill cm. 64x42x35h, temp: 50÷250°C, con 1 griglia cm.53x32,5 GN1/1 - Porta cieca inox
EN Range N. 4 plates - Static oven with grill cm. 64x42x35h, temp: 50÷250°C, with 1 grid cm.53x32,5 GN1/1 - Stainless steel door • **DE** Elektroherd N. 4 Kochplatten Statischer Ofen mit Grill cm. 64x42x35h, temp: 50÷250°C, with 1 grid cm.53x32,5 GN1/1 - Edelstahltür • **FR** Cuisinière N. 4 plaques - Four statique avec grill cm. 64x42x35h, temp: 50÷250°C, mit 1 Rost cm.53x32,5 GN1/1 - Porte acier inoxydable • **ES COCINA N. 4 PLANCHAS - HORNO ESTÁTICO CON ASADOR CM. 64X42X35H, TEMP: 50÷250 °C, CON 1 PARILLA CM.53X32,5 GN1/1 - PUERTA CIEGA INOX cm. 80x 65x 87h**



⚡ 10,62 KW 3.335,00
400V~3N 95 / 0,78
230V~3
50/60 Hz

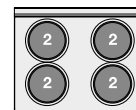

CF4-8G
07680850

cucina a gas 4 fuochi Forno a gas statico con grill cm. 64x39x35h, temp: 125÷275°C, con 1 griglia cm.53x32,5 GN1/1 - Porta vetro
EN Gas range - N. 4 burners - Gas static oven with grill cm. 64x39x35h, temp: 125÷275°C, with 1 grid cm.53x32,5 GN1/1 - glass door • **DE** Gasherd - N. 4 Kochstellen - Gas Statischer Backofen mit grill cm. 64x39x35h, temp: 125÷275°C, mit 1 Rost cm.53x32,5 GN1/1 - Glastür • **FR** Cuisinière gaz - N. 4 feux vifs - Four gaz statique avec grill cm. 64x39x35h, temp: 125÷275°C, avec 1 grille cm.53x32,5 GN1/1 - Porte vitrée • **ES COCINA GAS - N. 4 QUEMADORES - HORNO GAS ESTÁTICO CON ASADOR CM. 64X39X35H, TEMP: 125÷275 °C, CON 1 PARILLA CM.53X32,5 GN1/1 - PUERTA VIDRIO cm. 80x 65x 87h**



⚡ 22 kW 4.409,00
18.920 kcal/h 97 / 0,78
⚡ 0,03 kW
230V~
50/60 Hz

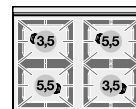

CF4-8G
07680851

cucina a gas 4 fuochi Forno a gas statico con grill cm. 64x39x35h, temp: 125÷275°C, con 1 griglia cm.53x32,5 GN1/1 - Porta cieca inox
EN Gas range - N. 4 burners - Gas static oven with grill cm. 64x39x35h, temp: 125÷275°C, with 1 grid cm.53x32,5 GN1/1 - Stainless steel door • **DE** Gasherd - N. 4 Kochstellen - Gas Statischer Backofen mit grill cm. 64x39x35h, temp: 125÷275°C, mit 1 Rost cm.53x32,5 GN1/1 - Edelstahltür/Porte acier inoxydable • **FR** Cuisinière gaz - N. 4 feux vifs - Four gaz statique avec grill cm. 64x39x35h, temp: 125÷275°C, avec 1 grille cm.53x32,5 GN1/1 - Porte acier inoxydable • **ES COCINA GAS - N. 4 QUEMADORES - HORNO GAS ESTÁTICO CON ASADOR CM. 64X39X35H, TEMP: 125÷275 °C, CON 1 PARILLA CM.53X32,5 GN1/1 - PUERTA CIEGA INOX cm. 80x 65x 87h**



⚡ 22 kW 4.409,00
18.920 kcal/h 97 / 0,78
⚡ 0,03 kW
230V~
50/60 Hz

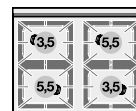

CF4-8GEM
07690860

CUCINA MISTA 4 FUOCHI CON Forno elettrico multifunzione - Camera cm. 64x37x35h, temp: 50÷250°C, con 1 griglia cm.53x32,5 GN1/1 - Porta vetro
EN Combined range - N. 4 burners Multifunction oven - Chamber cm. 64x37x35h, temp: 50÷250°C, with 1 grid cm.53x32,5 GN1/1 - Glass door • **DE** Gemischtherd - N. 4 Kochstellen Multifunktions-Ofen cm. 64x37x35h, temp: 50÷250°C, with 1 grid cm.53x32,5 GN1/1 - Glastür • **FR** Cuisinière mixte - N. 4 feux vifs Four à fonctions multiples cm. 64x37x35h, temp: 50÷250°C, avec 1 grille cm.53x32,5 GN1/1 - Porte vitrée • **ES COCINA MIXTA - N. 4 QUEMADORES HORNO MULTIFUNCIONAL - CÁMARA CM. 64X37X35H, TEMP: 50÷250 °C, CON 1 PARILLA CM.53X32,5 GN1/1 - PUERTA VIDRIO cm. 80x 65x 87h**



⚡ 18 kW 4.426,00
15.480 kcal/h 96 / 0,78
⚡ 3,11 kW
230V~
50/60 Hz

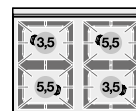

CUCINE A GAS CON FORNO ELETTRICO

MOD. _____
COD. _____

DESCRIZIONE/DESCRIPTION/BEZEICHNUNG/DESCRIPTION/DESCRIPCIÓN
DIMENSIONI/DIMENSIONS/ABMESSUNGEN/DIMENSIONS/DIMENSIONES

POTENZA/POWER/LEISTUNG/PUISSANCE/POTENCIA
VOLTAGGIO/VOLTAGE/SPANNUNG/VOLTAGE/VOLTAJE

⚡ kW _____
kcal/h _____
⚡ kW _____
V~ _____
Hz _____

PREZZO/PRICE €
PREIS/PRIX/PRECIO €
KG / M³

CF4-8GEM
07690861

CUCINA MISTA 4 FUOCHI CON Forno elettrico multifunzione - Camera cm. 64x37x35h, temp: 50÷250°C, con 1 griglia cm.53x32,5 GN1/1 - Porta cieca inox
EN Combined range - N. 4 burners Multifunction oven - Chamber cm. 64x37x35h, temp: 50÷250°C, with 1 grid cm.53x32,5 GN1/1 - Stainless steel door • **DE** Gemischtherd - N. 4 Kochstellen Multifunktions-Ofen cm. 64x37x35h, temp: 50÷250°C, with 1 grid cm.53x32,5 GN1/1 - Edelstahltür • **FR** Cuisinière mixte - N. 4 feux vifs Four à fonctions multiples cm. 64x37x35h, temp: 50÷250°C, avec 1 grille cm.53x32,5 GN1/1 - Porte acier inoxydable • **ES COCINA MIXTA - N. 4 QUEMADORES HORNO MULTIFUNCIONAL - CÁMARA CM. 64X37X35H, TEMP: 50÷250°C, CON 1 PARILLA CM.53X32,5 GN1/1 - PUERTA CIEGA INOX cm. 80x 65x 87h**



⚡ 18 kW _____ **4.426,00**
15.480 kcal/h _____ 96 / 0,78

⚡ 3,11 kW _____
230V~ _____
50/60 Hz _____

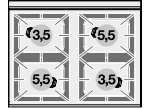

CF4-8GEMS
07690862

CUCINA MISTA 4 FUOCHI CON Forno elettrico statico c/grill cm. 64x42x35h, temp: 50÷250°C, con 1 griglia cm.53x32,5 GN1/1 - Porta vetro
EN Combined range static oven - N. 4 burners Static oven with grill cm. 64x42x35h, temp: 50÷250°C, with 1 grid cm.53x32,5 GN1/1 - Glass door • **DE** Gemischtherd statischer Ofen - N. 4 Kochstellen Statischer Ofen mit Grill cm. 64x42x35h, temp: 50÷250°C, with 1 grid cm.53x32,5 GN1/1 - Glasür • **FR** Cuisinière mixte gaz four estático - N. 4 feux vifs Four statique avec grill cm. 64x42x35h, temp: 50÷250°C, mit 1 Rost cm.53x32,5 GN1/1 - Porte vitrée • **ES COCINA MIXTA HORNO ESTÁTICO - N. 4 QUEMADORES HORNO ESTÁTICO CON ASADOR CM. 64X42X35H, TEMP: 50÷250°C, CON 1 PARILLA CM.53X32,5 GN1/1 - PUERTA VIDRIO cm. 80x 65x 87h**



⚡ 18 kW _____ **4.159,00**
15.480 kcal/h _____ 96 / 0,78

⚡ 2,62 kW _____
230V~ _____
50/60 Hz _____

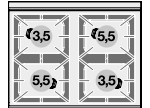

CF4-8GEMS
07690863

CUCINA MISTA 4 FUOCHI CON Forno elettrico statico c/grill cm. 64x42x35h, temp: 50÷250°C, con 1 griglia cm.53x32,5 GN1/1 - Porta cieca inox
EN Combined range static oven - N. 4 burners Static oven with grill cm. 64x42x35h, temp: 50÷250°C, with 1 grid cm.53x32,5 GN1/1 - Stainless steel door • **DE** Gemischtherd statischer Ofen - N. 4 Kochstellen Statischer Ofen mit Grill cm. 64x42x35h, temp: 50÷250°C, with 1 grid cm.53x32,5 GN1/1 - Edelstahltür • **FR** Cuisinière mixte gaz four estático - N. 4 feux vifs Four statique avec grill cm. 64x42x35h, temp: 50÷250°C, mit 1 Rost cm.53x32,5 GN1/1 - Porte acier inoxydable • **ES COCINA MIXTA HORNO ESTÁTICO - N. 4 QUEMADORES HORNO ESTÁTICO CON ASADOR CM. 64X42X35H, TEMP: 50÷250°C, CON 1 PARILLA CM.53X32,5 GN1/1 - PUERTA CIEGA INOX cm. 80x 65x 87h**



⚡ 18 kW _____ **4.159,00**
15.480 kcal/h _____ 96 / 0,78

⚡ 2,62 kW _____
230V~ _____
50/60 Hz _____

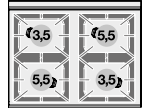

CP-4ET
07100430

CUOCIPISTA TRIFASE 17 LT. Vasca cm. 31x33,5x20h. N. 2 cestini cm. 15x29x15h - Elettrovalvola carico acqua - Rubinetto scarico + sfioratore.
EN Pasta cooker threephase 17 lts. Tank cm. 31x33,5x20h. N. 2 baskets cm. 15x29x15h - Water loading electro-valve Drain-cock + overflow device • **DE** Nudelkocher dreiphasig 17 lt. Becken cm. 31x33,5x20h. Wasserlauf Elektroventil - Ablasshahn + Überlauf vorrichtung N. 2 Körbe cm. 15x29x15h • **FR** Cuisseur à pâtes monophasé 17 lt. Cuve cm. 31x33,5x20h. N. 2 paniers cm. 15x29x15h - Soupape électrique d'arrivée d'eau Robinet de vidange + trop plein • **ES CUECE PASTA TRIFÁSICO 17 LT. - CUBA CM 31X33,5X20H. N. 2 CESTAS CM. 15X29X15H ELECTROVÁLVULA CARGA AGUA - GRIFO DESCARGA + VERTEDERO cm. 40x 65x 29h**



⚡ 4 kW _____ **2.106,00**
400V~2N _____ 27 / 0,18
230V~3 _____
230V~ _____
50/60 Hz _____

CP-6ET
07100630

CUOCIPISTA TRIFASE 25 LT. Vasca cm. 51x30,5x20h. N. 3 cestini cm. 15x29x15h - Elettrovalvola carico acqua - Rubinetto scarico + sfioratore.
EN Pasta cooker threephase 25 lts. Tank cm. 51x30,5x20h. N. 3 baskets cm. 15x29x15h - Water loading electro-valve Drain-cock + overflow device • **DE** Nudelkocher dreiphasig 25 lt. Becken cm. 51x30,5x20h. Wasserlauf Elektroventil - Ablasshahn + Überlauf vorrichtung N. 3 Körbe cm. 15x29x15h • **FR** Cuisseur à pâtes monophasé 25 lt. Cuve cm. 51x30,5x20h. N. 3 paniers cm. 15x29x15h - Soupape électrique d'arrivée d'eau Robinet de vidange + trop plein • **ES CUECE PASTA TRIFÁSICO 25 LT. - CUBA CM 51X30,5X20H. N. 3 CESTAS CM. 15X29X15H ELECTROVÁLVULA CARGA AGUA - GRIFO DESCARGA + VERTEDERO cm. 60x 65x 29h**



⚡ 6 kW _____ **2.934,00**
400V~3N _____ 42 / 0,27
230V~3 _____
50/60 Hz _____

CUOCIPASTA A GAS

MOD. _____ DESCRIZIONE/DESCRIPTION/BEZEICHNUNG/DESCRIPTION/DESCRIPCIÓN POTENZA/POWER/LEISTUNG/PUISSANCE/POTENCIA $\frac{kW}{kcal/h}$ $\frac{kW}{V\sim}$ PREZZO/PRICE €
 COD. _____ DIMENSIONI/DIMENSIONS/ABMESSUNGEN/DIMENSIONS/DIMENSIONES VOLTAGGIO/VOLTAGE/SPANNUNG/VOLTAGE/VOLTAJE Hz PREIS/PRIX/PRECIO €/KG / M³

CP-6G
07270650

CUOCIPASTA GAS - Vasca lt. 27 cm. 46x35x25h - N. 3 cesti cm. 14,5x29x11h - Rubinetto carico acqua + sfioratore
EN Gas pasta cooker - Tank capacity 27 lts. 46x35x25h N. 3 baskets cm. 14,5x29x11h Water loading cock + overflow device • **DE** Gas-Nudelkocher - Beckeninhalt lt. 27 cm. 46x35x25h N. 3 Körbe cm. 14,5x29x11h Wasserlauf Hahn + Überlaufvorrichtung • **FR** Cuiseur a pates gaz - Cuve lt. 27 46x35x25h - N. 3 paniers cm. 14,5x29x11h - Robinet d'arrivée d'eau + trop plein • **ES CUECE PASTA GAS - CUBA 27 LT. CM. 46X35X25H - N. 3 CESTAS CM. 14,5X29X11H - GRIFO CARGA AGUA + VERTEDERO cm. 60x 65x 29h**



$\frac{14 kW}{12.040 kcal/h}$ **3.219,00**
47 / 0,27

CPM-6G
07270651

CUOCIPASTA GAS SU MOBILE - Vasca lt. 40 cm. 51x31x30h. N. 3 cesti cm. 16x29x20h Rubinetto carico acqua, sfioratore + scarico a pavimento
EN Gas pasta cooker on cabinet - Tank capacity 40 lts cm. 51x31x30h. N. 3 baskets cm. 16x29x20h Water loading, cock, overflow device and floor draining • **DE** Gas-Nudelkocher Standgerät - Inhalt lt. 40 cm. 51x31x30h. N. 3 Körbe cm. 16x29x20h Wasserlauf Hahn, Überlauf und Ablauf am Boden • **FR** Cuiseur a pates sur coffre gaz - Cuve lt. 40 cm. 51x31x30h - N. 3 paniers cm. 16x29x20h - Robinet d'arrivée d'eau, trop plein + système de vidange au sol • **ES CUECE PASTA GAS EN MUEBLE - CUBA 40 LT. CM. 51X31X30H. N. 3 CESTAS CM. 16X29X20H - GRIFO CARGA AGUA + VERTEDERO + DESCARGA A PAVIMENTO cm. 60x 65x 87h**



$\frac{13,5 kW}{11.600 kcal/h}$ **5.157,00**
84 / 0,59

CW-4ET
07080430

GRIGLIA ELETTRICA TRIFASE Griglia in acciaio inox cm. 38x47 regolabile.
EN Electric grill threephase - Stainless steel adjustable grill cm. 38x47 • **DE** Elektro-Wurstbrater dreiphasig - Einstellbarer Rost aus Nirosta (cm. 38x47) • **FR** Grillade électrique triphase réglable - Grille inox cm 38x47 • **ES PARRILLA ELÉCTRICA TRIFÁSICA - PARRILLA DE ACERO INOX REGULABLE 38X47 CM cm. 40x 65x 29h**



$\frac{6 kW}{400V\sim 3N}$ **2.049,00**
 $\frac{35.5}{230V\sim 3}$ / 0,18
50/60 Hz

CW-6ET
07080630

GRIGLIA ELETTRICA TRIFASE N. 2 griglie in acciaio inox cm. 28x47 regolabili 2 zone di cottura
EN Electric grill threephase - N. 2 adjustable stainless steel grills cm. 28x47 - 2 cooking areas • **DE** Elektro-Wurstbrater dreiphasig - Nr. 2 einstellbare Roste aus Nirosta (cm. 28x47) - 2 Heizzone • **FR** Grillade électrique triphase - N. 2 grilles inox réglable cm 28x47 - 2 zones de cuisson • **ES PARRILLA ELÉCTRICA TRIFÁSICA - N. 2 PARRILLAS DE ACERO INOX REGULABLE 28X47 CM - 2 ZONAS DE COCCIÓN cm. 60x 65x 29h**



$\frac{8 kW}{400V\sim 3N}$ **3.015,00**
 $\frac{48}{230V\sim 3}$ / 0,27
50/60 Hz

CW-4G
07250450

GRIGLIA A GAS-PIETRALAVICA Griglia in acciaio inox cm. 38x47 regolabile.
EN Charcoal grill gas - Stainless steel adjustable grill cm. 38x47 • **DE** Gas Lavasteingrill - Einstellbarer Rost aus Nirosta (cm. 38x47) • **FR** Grille a gaz en pierre de lave Grille réglable en acier inox cm. 38x47 • **ES PARRILLA A GAS PIEDRA LÁVICA PARRILLA DE ACERO INOX REGULABLE 38X47 CM cm. 40x 65x 29h**



$\frac{6,5 kW}{5.590 kcal/h}$ **2.301,00**
41.5 / 0,18

CW-6G
07250650

GRIGLIA A GAS-PIETRALAVICA - N. 2 griglie in acciaio inox cm. 28x47 regolabili. 2 zone di cottura
EN Charcoal grill gas - N. 2 Stainless steel adjustable grill cm. 28x47 - 2 cooking areas • **DE** Gas Lavasteingrill - Nr. 2 einstellbare Roste aus Nirosta (cm. 28x47) - 2 Heizzonen • **FR** Grille à gaz en pierre de lave - N. 2 grilles réglables en acier inox - cm. 28x47 - 2 zones de cuisson • **ES PARRILLA A GAS PIEDRA LÁVICA - PARRILLA DE ACERO INOX REGULABLE 28X47 CM - 2 ZONAS DE COCCIÓN cm. 60x 65x 29h**



$\frac{9,8 kW}{8.420 kcal/h}$ **3.407,00**
58.5 / 0,27

FRIGGITRICI ELETTRICHE

MOD. _____
COD. _____

DESCRIZIONE/DESCRIPTION/BEZEICHNUNG/DESCRIPTION/DESCRIPCIÓN
DIMENSIONI/DIMENSIONS/ABMESSUNGEN/DIMENSIONS/DIMENSIONES

POTENZA/POWER/LEISTUNG/PUISSANCE/POTENCIA
VOLTAGGIO/VOLTAGE/SPANNUNG/VOLTAGE/VOLTAJE

⚡ kW _____
kcal/h _____
V~ _____
Hz _____

PREZZO/PRICE €
PREIS/PRIX/PRECIO €
KG / M³

FQ-4EM
07090410

FRIGGITRICE Vasca lt. 10 cm. 22x35x22h - Cesto cm. 20x30x10h
Produzione patate 8 kg/h
EN Fryer - Tank capacity 10 lts. cm. 22x35x22h Basket cm. 20x30x10h
- Production 8 kg/hr • **DE** Friteuse - Becken lt. 10 cm. 22x35x22h Körb
cm. 20x30x10h - Pommes frites 8 kg/pro Stunde • **FR** Friteuse - Cuve
10 lt. cm. 22x35x22h - Panier cm 20x30x10h - Production de pommes
frites 8 kg/h • **ES FREIDORA - CUBA 10 LT. - CM. 22X35X22H**
CESTA CM. 20X30X10H - PRODUCCIÓN PATATAS 8 KG/H
cm. 40x 65x 29h



⚡ 3,65 kW _____ **1.417,00**
230V~ _____ 25.5 / 0,18
50/60 Hz

FQ-4ET
07090430

FRIGGITRICE TRIFASE Vasca lt. 10 cm. 22x35x22h - Cesto cm.
20x30x10h Produzione patate 10 kg/h
EN Fryer threephase - Tank capacity 10 lts. cm. 22x35x22h Basket cm.
20x30x10h - Production 10 kg/hr • **DE** Friteuse dreiphasig - Becken
lt. 10 cm. 22x35x22h Körb cm. 20x30x10h - Pommes frites 10 kg/pro
Stunde • **FR** Friteuse triphase - Cuve 10 lt. cm. 22x35x22h - Panier cm
20x30x10h - Production de pommes frites 10 Kg/h • **ES FREIDORA**
TRIFÁSICA - CUBA 10 LT. - CM. 22X35X22H CESTA CM.
20X30X10H - PRODUCCIÓN PATATAS 10 KG/H
cm. 40x 65x 29h

⚡ 7,15 kW _____ **1.617,00**
400V~3N _____ 26.5 / 0,18
230V~3 _____
50/60 Hz

FQ-6EM
07090610

FRIGGITRICE 2 Vasche lt. 10 cm. 22x35x22h - 2 Cesti cm. 20x30x10h
Produzione patate 16 kg/h
EN Fryer - 2 Tanks capacity 10 lts. cm. 22x35x22h - 2 Baskets cm.
20x30x10h - Production 16 kg/hr • **DE** Friteuse - 2 Becken lt. 10
cm. 22x35x22h - 2 Körbe cm. 20x30x10h - Pommes frites 16 kg/pro
Stunde • **FR** Friteuse - 2 Cuves 10 l. cm. 22x35x22h - 2 Paniers cm
20x30x10h - Production de pommes frites 16 kg/h • **ES FREIDORA- 2**
CUBAS 10 L. CM. 22X35X22H - 2 CESTAS CM 20X30X10H -
PRODUCCIÓN PATATAS 16 KG/H
cm. 60x 65x 29h



⚡ 7,2 kW _____ **2.846,00**
230V~ _____ 39.5 / 0,27
50/60 Hz

FQ-6ET
07090630

FRIGGITRICE TRIFASE 2 Vasche lt. 10 cm. 22x35x22h - 2 Cesti cm.
20x30x10h Produzione patate 20 kg/h
EN Fryer threephase - 2 Tanks capacity 10 lts. cm. 22x35x22h - 2
Baskets cm. 20x30x10h - Production 20 kg/hr • **DE** Friteuse dreiphasig -
2 Becken lt. 10 cm. 22x35x22h - 2 Körbe cm. 20x30x10h - Pommes frites
20 kg/pro Stunde • **FR** Friteuse triphase - 2 Cuves 10 l. cm. 22x35x22h
- 2 Paniers cm 20x30x10h - Production de pommes frites 20 Kg/h • **ES**
FREIDORA TRIFÁSICA - 2 CUBAS 10 L. CM. 22X35X22H - 2
CESTAS CM 20X30X10H - PRODUCCIÓN PATATAS 20 KG/H
cm. 60x 65x 29h

⚡ 14,3 kW _____ **3.001,00**
400V~3N _____ 41.5 / 0,27
230V~3 _____
50/60 Hz

FP-6ET
07091630

FRIGGITRICE Vasca lt. 23 cm. 50x35x22h - Cesto cm. 46x30x10h
EN Fryer - Tank capacity 23 lts. cm. 50x35x24h Basket cm. 46x30x10h
• **DE** Friteuse - Becken lt. 23 cm. 50x35x22h Körb cm. 46x30x10h
• **FR** Friteuse - Cuve 23 l. cm. 50x35x22h Panier cm 46x30x10h
• **ES FREIDORA - CUBA 23 L. CM. 50X35X22H CESTA CM.**
46X30X10H
cm. 60x 65x 29h

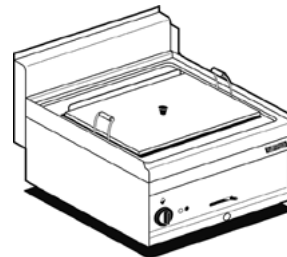

⚡ 14,3 kW _____ **2.499,00**
400V~3N _____ 40 / 0,27
50/60 Hz

FQ-4G
07260450

FRIGGITRICE GAS - Vasca lt. 10 cm. 22x35x25h - Cesto cm. 20x30x10h -
Produzione patate: 10 kg/h
EN Gas fryer - Tank capacity 10 lts. cm. 22x35x25h Basket cm.
20x30x10h - Production: 10 kg/h • **DE** Gas-Einzelfriteuse - Beckeninhalte
lt. 10 cm. 22x35x25h Korb cm. 20x30x10h - Pommes frites: 10 kg/
pro Stunde • **FR** Friteuse gaz - Cuve lt. 10. cm. 22x35x25h Panier cm.
20x30x10h - Production de pommes frites: 10 kg/h • **ES FREIDORAS**
GAS - CUBA 10 L. CM 22X35X25H CESTA CM. 20X30X10H -
PRODUCCIÓN PATATAS: 10 KG/H
cm. 40x 65x 29h



⚡ 7 kW _____ **2.186,00**
6.020 kcal/h _____ 30 / 0,18

FRIGGITRICI A GAS

MOD. / COD. DESCRIZIONE / DESCRIPTION / BEZEICHNUNG / DESCRIPTION / DESCRIPCIÓN DIMENSIONI / DIMENSIONS / ABMESSUNGEN / DIMENSIONS / DIMENSIONES POTENZA / POWER / LEISTUNG / PUISSANCE / POTENCIA VOLTAGGIO / VOLTAGE / SPANNUNG / VOLTAGE / VOLTAJE $\frac{kW}{kcal/h}$ $\frac{kW}{V}$ / Hz PREZZO / PRICE € PREIS / PRIX / PRECIO € KG / M³

FQ-6G
07260650

FRIGGITRICE GAS - 2 vasche lt. 10 cm.22x35x25h 2 cesti cm. 20x30x10h - Produzione patate: 20 kg/h
EN Gas fryer - 2 tanks capacity 10 lts. cm.22x35x25h 2 baskets cm. 20x30x10h - Production: 20 kg/h • **DE** Gas-Doppelfriteuse - lt. 10 + 10 Becken cm. 22x35x25h - 2 Korbe cm.20x30x10h Pommes frites: 20 kg/pro Stunde • **FR** Friteuse gaz - 2 Cuves 10 lt. cm.22x35x25h 2 Paniers cm. 20x30x10h Production de pommes frites: 20 kg/h • **ES FREIDORAS GAS - 2 CUBA 10 L. CM22X35X25H 2 CESTAS CM. 20X30X10H - PRODUCCIÓN PATATAS: 20 KG/H cm. 60x 65x 29h**



$\frac{14 kW}{12.040 kcal/h}$ **3.447,00**
48.5 / 0,27

FP-6G
07260652

FRIGGITRICE GAS - Vasca lt. 20 cm.46x35x25h Cesto cm. 42,5x31x10h
EN Gas fryer - Tank capacity 20 lts. cm. 46x35x25h Basket cm. 42,5x31x10h • **DE** Gas-Einzelfriteuse - Beckeninhalte lt. 20 cm. 46x35x25h Korb cm. 42,5x31x10h • **FR** Friteuse gaz - Cuve lt. 20 cm. 46x35x25h Panier cm. 42,5x31x10h • **ES FREIDORAS GAS - CUBA 20 LT. 46X35X25H CM. CESTA CM. 42,5X31X10H cm. 60x 65x 29h**



$\frac{14 kW}{12.040 kcal/h}$ **2.872,00**
44.5 / 0,27

FQM-4G
07260451

FRIGGITRICE GAS SU MOBILE - Vasca lt. 15 cm. 33x38x38h - Cesto cm. 30x33x12h - Bacinella raccogli olio con filtro - Produzione patate: 15 kg/h
EN Gas fryer on cabinet - Tank capacity 15 lts.cm. 33x38x38h - Basket cm. 30x33x12h Production: 15 kg/h - Drip tray with sieve • **DE** Gas-Standfriteuse - Beckeninhalte lt. 15 cm.33x38x38h Korb cm. 30x33x12h - Fettaufangschale mit Sieb, Pommes frites: 15 kg/pro Stunde • **FR** Friteuse gaz sur placard - Cuve lt 15 cm.33x38x38h Panier cm. 30x33x12h - Production de pommes frites: 15 kg/h - Bac de récupération de l'huile et filtre • **ES FREIDORA GAS EN MUEBLE - CUBA 15 L. CM33X38X38H CESTA CM. 30X33X12H - BANDEJA RECOGE ACEITE CON FILTRO PRODUCCIÓN PATATAS: 15 KG/H cm. 40x 65x 87h**



$\frac{13,5 kW}{11.650 kcal/h}$ **2.988,00**
60 / 0,40

FTL-4EM
07060411

Fry-top elettrico liscio, piastra cm.35,5x55
EN Electric Fry-top smooth griddle, plate cm.35,5x55 • **DE** Griddleplatte elektrische glatt, platte cm.35,5x55 • **FR** Plaque électriques lisse, plaque cm.35,5x55 • **ES FRY-TOP ELÉCTRICO LISO, PLANCHA CM.35,5X55 cm. 40x 65x 29h**



$\frac{3 kW}{230V\sim}$ **1.348,00**
50/60 Hz 49 / 0,18

FTL-4ET
07060431

cm. 40x 65x 29h

$\frac{4,5 kW}{400V\sim 3N}$ **1.445,00**
230V~3 49 / 0,18
50/60 Hz

FTL-4EMS
07060414

Fry-top elettrico liscio cromato SUPERCHROME (Moca Approved, piastra cm.35,5x55
EN Electric Fry-top smooth chromed griddle SUPERCHROME (Moca Approved), plate cm.35,5x55 • **DE** Griddleplatte elektrische glatt hartverchromt SUPERCHROME (Moca Approved), platte cm.35,5x55 • **FR** Plaque électriques lisse chromée SUPERCHROME (Moca Approved), plaque cm.35,5x55 • **ES FRY-TOP ELÉCTRICO LISO CROMADO SUPERCHROME (MOCA APPROVED), PLANCHA CM.35,5X55 cm. 40x 65x 29h**

$\frac{3 kW}{230V\sim}$ **1.719,00**
50/60 Hz 49 / 0,18

FTL-4ETS
07060434

cm. 40x 65x 29h

$\frac{4,5 kW}{400V\sim 3N}$ **1.857,00**
230V~3 49 / 0,18
50/60 Hz

FRY-TOP ELETTRICI

MOD. _____
COD. _____

DESCRIZIONE/DESCRIPTION/BEZEICHNUNG/DESCRIPTION/DESCRIPCIÓN
DIMENSIONI/DIMENSIONS/ABMESSUNGEN/DIMENSIONS/DIMENSIONES

POTENZA/POWER/LEISTUNG/PUISSANCE/POTENCIA
VOLTAGGIO/VOLTAGE/SPANNUNG/VOLTAGE/VOLTAJE

⚡ kW _____
kcal/h _____
V~ _____
Hz _____

PREZZO/PRICE €
PREIS/PRIX/PRECIO
KG / M³

FTR-4EM
07060413

Fry-top elettrico rigato, piastra cm.35,5x55
EN Electric Fry-top grooved griddle, plate cm.35,5x55 • **DE** Griddleplatte elektrische gerillt, platte cm.35,5x55 • **FR** Plaque électriques nervurée, plaque cm.35,5x55 • **ES FRY-TOP ELÉCTRICO ESTRIADO, PLANCHA CM.35,5X55**
cm. 40x 65x 29h

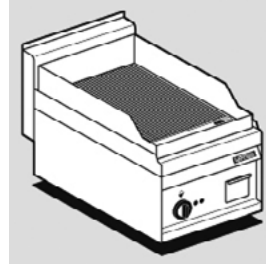

⚡ 3 kW _____ **1.566,00**
230V~ _____ 49 / 0,18
50/60 Hz



FTR-4ET
07060433

cm. 40x 65x 29h

⚡ 4,5 kW _____ **1.631,00**
400V~3N _____ 49 / 0,18
230V~3 _____
50/60 Hz

FTR-4EMS
07060416

Fry-top elettrico rigato cromato SUPERCHROME (Moca Approved, piastra cm.35,5x55
EN Electric Fry-top grooved chromed griddle SUPERCHROME (Moca Approved), plate cm.35,5x55 • **DE** Griddleplatte elektrische gerillt hartverchromt SUPERCHROME (Moca Approved), platte cm.35,5x55 • **FR** Plaque électriques nervurée chromée SUPERCHROME (Moca Approved), plaque cm.35,5x55 • **ES FRY-TOP ELÉCTRICO ESTRIADO CROMADO SUPERCHROME (MOCA APPROVED), PLANCHA CM.35,5X55**
cm. 40x 65x 29h

⚡ 3 kW _____ **1.906,00**
230V~ _____ 49 / 0,18
50/60 Hz



FTR-4ETS
07060436

cm. 40x 65x 29h

⚡ 4,5 kW _____ **2.039,00**
400V~3N _____ 49 / 0,18
230V~3 _____
50/60 Hz

FTL-6ET
07060631

Fry-top elettrico liscio, piastra cm.55,5x55 - 2 zone di cottura
EN Electric Fry-top smooth griddle, plate cm.55,5x55 - 2 cooking areas
• **DE** Griddleplatte elektrische glatt, platte cm.55,5x55 - 2 Heizzonen
• **FR** Plaque électriques lisse, plaque cm.55,5x55 - 2 zones de cuisson
• **ES FRY-TOP ELÉCTRICO LISO, PLANCHA CM.55,5X55 - 2 ZONAS DE COCCIÓN**
cm. 60x 65x 29h

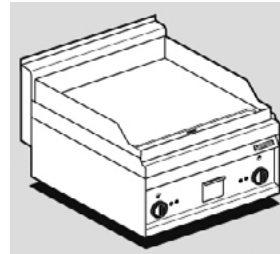

⚡ 6 kW _____ **1.972,00**
400V~3N _____ 66.5 / 0,27
230V~3 _____
230V~ _____
50/60 Hz



FTL-6ETS
07060634

Fry-top elettrico liscio cromato SUPERCHROME (Moca Approved, piastra cm.55,5x55 - 2 zone di cottura
EN Electric Fry-top smooth chromed griddle SUPERCHROME (Moca Approved), plate cm.55,5x55 - 2 cooking areas • **DE** Griddleplatte elektrische glatt hartverchromt SUPERCHROME (Moca Approved), platte cm.55,5x55 - 2 Heizzonen • **FR** Plaque électriques lisse chromée SUPERCHROME (Moca Approved), plaque cm.55,5x55 - 2 zones de cuisson • **ES FRY-TOP ELÉCTRICO LISO CROMADO SUPERCHROME (MOCA APPROVED), PLANCHA CM.55,5X55 - 2 ZONAS DE COCCIÓN**
cm. 60x 65x 29h

⚡ 6 kW _____ **2.678,00**
400V~3N _____ 66.5 / 0,27
230V~3 _____
230V~ _____
50/60 Hz



FTLR-6ET
07060632

Fry-top elettrico 1/2 rigato + 1/2 liscio, piastra cm.55,5x55 - 2 zone di cottura
EN Electric Fry-top 1/2 grooved + 1/2 smooth, plate cm.55,5x55 - 2 cooking areas • **DE** Griddleplatte elektrische 1/2 gerillt + 1/2 glatt, platte cm.55,5x55 - 2 Heizzonen • **FR** Plaque électriques 1/2 nervurée + 1/2 lisse, plaque cm.55,5x55 - 2 zones de cuisson • **ES FRY-TOP ELÉCTRICO 1/2 ESTRIADO + 1/2 LISO, PLANCHA CM.55,5X55 - 2 ZONAS DE COCCIÓN**
cm. 60x 65x 29h

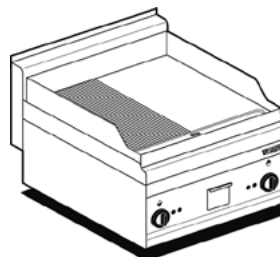

⚡ 6 kW _____ **2.159,00**
400V~3N _____ 66.5 / 0,27
230V~3 _____
230V~ _____
50/60 Hz



FRY-TOP ELETTRICI

MOD. _____
COD. _____

DESCRIZIONE/DESCRIPTION/BEZEICHNUNG/DESCRIPTION/DESCRIPCIÓN
DIMENSIONI/DIMENSIONS/ABMESSUNGEN/DIMENSIONS/DIMENSIONES

POTENZA/POWER/LEISTUNG/PUISSANCE/POTENCIA
VOLTAGGIO/VOLTAGE/SPANNUNG/VOLTAGE/VOLTAJE

⚡ kW kcal/h ⚡ kw V~ Hz

PREZZO/PRICE € PREIS/PRIX/PRECIO € KG / M³

FTLR-6ETS
07060635

Fry-top elettrico 1/2 rigato + 1/2 liscio cromato SUPERCHROME (Moca Approved, piastra cm.55,5x55 - 2 zone di cottura
EN Electric Fry-top 1/2 grooved + 1/2 smooth chromed griddle SUPERCHROME (Moca Approved), plate cm.55,5x55 - 2 cooking areas
• **DE** Griddleplatte elektrische 1/2 gerillt + 1/2 glatt hartverchromt SUPERCHROME (Moca Approved), platte cm.55,5x55 - 2 Heizzonen
• **FR** Plaque électriques 1/2 nervurée + 1/2 lisse chromée SUPERCHROME (Moca Approved), plaque cm.55,5x55 - 2 zones de cuisson • **ES FRY-TOP ELÉCTRICO 1/2 ESTRIADO + 1/2 LISO CROMADO SUPERCHROME (MOCA APPROVED), PLANCHA CM.55,5X55 - 2 ZONAS DE COCCIÓN**

cm. 60x 65x 29h

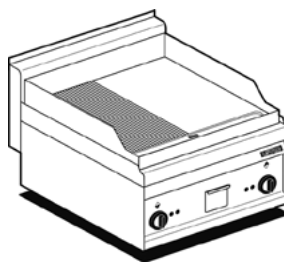

⚡ 6 kW 2.865,00
400V~3N 66.5 / 0,27
230V~3
230V~
50/60 Hz



FTR-6ET
07060633

Fry-top elettrico rigato, piastra cm.55,5x55 - 2 zone di cottura
EN Electric Fry-top grooved griddle, plate cm.55,5x55 - 2 cooking areas
• **DE** Griddleplatte elektrische gerillt, platte cm.55,5x55 - 2 Heizzonen
• **FR** Plaque électriques nervurée, plaque cm.55,5x55 - 2 zones de cuisson • **ES FRY-TOP ELÉCTRICO ESTRIADO, PLANCHA CM.55,5X55 - 2 ZONAS DE COCCIÓN**

cm. 60x 65x 29h

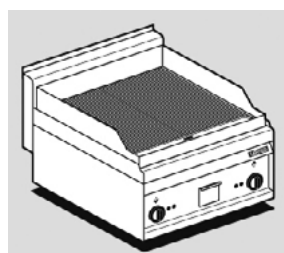

⚡ 6 kW 2.343,00
400V~3N 66.5 / 0,27
230V~3
230V~
50/60 Hz

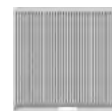

FTR-6ETS
07060636

Fry-top elettrico rigato cromato SUPERCHROME (Moca Approved, piastra cm.55,5x55 - 2 zone di cottura
EN Electric Fry-top grooved chromed griddle SUPERCHROME (Moca Approved), plate cm.55,5x55 - 2 cooking areas • **DE** Griddleplatte elektrische gerillt hartverchromt SUPERCHROME (Moca Approved), platte cm.55,5x55 - 2 Heizzonen • **FR** Plaque électriques nervurée chromée SUPERCHROME (Moca Approved), plaque cm.55,5x55 - 2 zones de cuisson • **ES FRY-TOP ELÉCTRICO ESTRIADO CROMADO SUPERCHROME (MOCA APPROVED), PLANCHA CM.55,5X55 - 2 ZONAS DE COCCIÓN**

cm. 60x 65x 29h

⚡ 6 kW 3.052,00
400V~3N 66.5 / 0,27
230V~3
230V~
50/60 Hz



FTL-8ET
07060831

Fry-top elettrico liscio, piastra cm.75,5x55 - 2 zone di cottura
EN Electric Fry-top smooth griddle, plate cm.75,5x55 - 2 cooking areas
• **DE** Griddleplatte elektrische glatt, platte cm.75,5x55 - 2 Heizzonen
• **FR** Plaque électriques lisse, plaque cm.75,5x55 - 2 zones de cuisson • **ES FRY-TOP ELÉCTRICO LISO, PLANCHA CM.75,5X55 - 2 ZONAS DE COCCIÓN**

cm. 80x 65x 29h

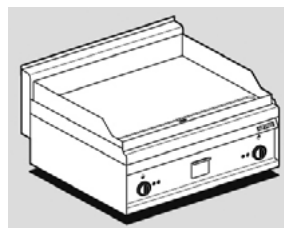

⚡ 9 kW 2.728,00
400V~3N 82 / 0,35
230V~3
50/60 Hz



FTL-8ETS
07060834

Fry-top elettrico liscio cromato SUPERCHROME (Moca Approved, piastra cm.75,5x55 - 2 zone di cottura
EN Electric Fry-top smooth chromed griddle SUPERCHROME (Moca Approved), plate cm.75,5x55 - 2 cooking areas • **DE** Griddleplatte elektrische glatt hartverchromt SUPERCHROME (Moca Approved), platte cm.75,5x55 - 2 Heizzonen • **FR** Plaque électriques lisse chromée SUPERCHROME (Moca Approved), plaque cm.75,5x55 - 2 zones de cuisson • **ES FRY-TOP ELÉCTRICO LISO CROMADO SUPERCHROME (MOCA APPROVED), PLANCHA CM.75,5X55 - 2 ZONAS DE COCCIÓN**

cm. 80x 65x 29h

⚡ 9 kW 3.569,00
400V~3N 82 / 0,35
230V~3
50/60 Hz



FTLR-8ET
07060832

Fry-top elettrico 1/2 rigato + 1/2 liscio, piastra cm.75,5x55 - 2 zone di cottura
EN Electric Fry-top 1/2 grooved + 1/2 smooth, plate cm.75,5x55 - 2 cooking areas • **DE** Griddleplatte elektrische 1/2 gerillt + 1/2 glatt, platte cm.75,5x55 - 2 Heizzonen • **FR** Plaque électriques 1/2 nervurée + 1/2 lisse, plaque cm.75,5x55 - 2 zones de cuisson • **ES FRY-TOP ELÉCTRICO 1/2 ESTRIADO + 1/2 LISO, PLANCHA CM.75,5X55 - 2 ZONAS DE COCCIÓN**

cm. 80x 65x 29h



⚡ 9 kW 2.928,00
400V~3N 82 / 0,35
230V~3
50/60 Hz



FRY-TOP ELETTRICI

MOD. _____
COD. _____

DESCRIZIONE/DESCRIPTION/BEZEICHNUNG/DESCRIPTION/DESCRIPCIÓN
DIMENSIONI/DIMENSIONS/ABMESSUNGEN/DIMENSIONS/DIMENSIONES

POTENZA/POWER/LEISTUNG/PUISSANCE/POTENCIA
VOLTAGGIO/VOLTAGE/SPANNUNG/VOLTAGE/VOLTAJE

⚡ kW
kcal/h
⚡ kw
V~
Hz

PREZZO/PRICE €
PREIS/PRIX/PRECIO
KG / M³

FTLR-8ETS
07060835

Fry-top elettrico 1/2 rigato + 1/2 liscio cromato SUPERCHROME (Moca Approved, piastra cm.75,5x55 - 2 zone di cottura
EN Electric Fry-top 1/2 grooved + 1/2 smooth chromed griddle SUPERCHROME (Moca Approved), plate cm.75,5x55 - 2 cooking areas
• **DE** Griddleplatte elektrische 1/2 gerillt + 1/2 glatt hartverchromt SUPERCHROME (Moca Approved), platte cm.75,5x55 - 2 Heizzonen
• **FR** Plaque électriques 1/2 nervurée + 1/2 lisse chromée SUPERCHROME (Moca Approved), plaque cm.75,5x55 - 2 zones de cuisson • **ES FRY-TOP ELÉCTRICO 1/2 ESTRIADO + 1/2 LISO CROMADO SUPERCHROME (MOCA APPROVED), PLANCHA CM.75,5X55 - 2 ZONAS DE COCCIÓN**

cm. 80x 65x 29h



⚡ 9 kW
400V~3N
230V~3
50/60 Hz

3.786,00
82 / 0,35



FTL-4G
07230451

Fry-top gas liscio, piastra cm.35,5x55
EN Gas Fry-top smooth griddle, plate cm.35,5x55 • **DE** Gas-griddleplatte glatt, platte cm.35,5x55 • **FR** Plaque gaz lisse, plaque cm.35,5x55 • **ES FRY-TOP GAS LISO, PLANCHA CM.35,5X55**
cm. 40x 65x 29h



⚡ 7 kW
6.020 kcal/h

1.675,00
46 / 0,18



FTL-4GS
07230454

Fry-top gas liscio cromato SUPERCHROME (Moca Approved, piastra cm.35,5x55
EN Gas Fry-top smooth chromed griddle SUPERCHROME (Moca Approved), plate cm.35,5x55 • **DE** Gas-griddleplatte glatt hartverchromt SUPERCHROME (Moca Approved), platte cm.35,5x55 • **FR** Plaque gaz lisse chromée SUPERCHROME (Moca Approved), plaque cm.35,5x55
• **ES FRY-TOP GAS LISO CROMADO SUPERCHROME (MOCA APPROVED), PLANCHA CM.35,5X55**
cm. 40x 65x 29h



⚡ 7 kW
6.020 kcal/h

2.282,00
46 / 0,18



FTR-4G
07230453

Fry-top gas rigato, piastra cm.35,5x55
EN Gas Fry-top grooved griddle, plate cm.35,5x55 • **DE** Gas-griddleplatte gerillt, platte cm.35,5x55 • **FR** Plaque gaz nervurée, plaque cm.35,5x55 • **ES FRY-TOP GAS ESTRIADO, PLANCHA CM.35,5X55**
cm. 40x 65x 29h

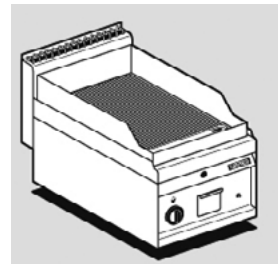

⚡ 7 kW
6.020 kcal/h

1.888,00
46 / 0,18



FTR-4GS
07230456

Fry-top gas rigato cromato SUPERCHROME (Moca Approved, piastra cm.35,5x55
EN Gas Fry-top grooved chromed griddle SUPERCHROME (Moca Approved), plate cm.35,5x55 • **DE** Gas-griddleplatte gerillt hartverchromt SUPERCHROME (Moca Approved), platte cm.35,5x55
• **FR** Plaque gaz nervurée chromée SUPERCHROME (Moca Approved), plaque cm.35,5x55 • **ES FRY-TOP GAS ESTRIADO CROMADO SUPERCHROME (MOCA APPROVED), PLANCHA CM.35,5X55**
cm. 40x 65x 29h



⚡ 7 kW
6.020 kcal/h

2.480,00
46 / 0,18



FTL-6G
07230651

Fry-top gas liscio, piastra cm.55,5x55 - 2 zone di cottura
EN Gas Fry-top smooth griddle, plate cm.55,5x55 - 2 cooking areas
• **DE** Gas-griddleplatte glatt, platte cm.55,5x55 - 2 Heizzonen • **FR** Plaque gaz lisse, plaque cm.55,5x55 - 2 zones de cuisson • **ES FRY-TOP GAS LISO, PLANCHA CM.55,5X55 - 2 ZONAS DE COCCIÓN**
cm. 60x 65x 29h

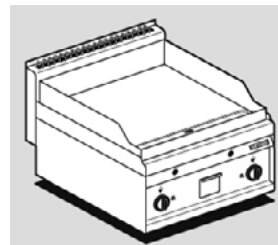

⚡ 10,5 kW
9.030 kcal/h

2.227,00
65.5 / 0,27

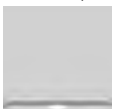

FTL-6GS
07230654

Fry-top gas liscio cromato SUPERCHROME (Moca Approved, piastra cm.55,5x55 - 2 zone di cottura
EN Gas Fry-top smooth chromed griddle SUPERCHROME (Moca Approved), plate cm.55,5x55 - 2 cooking areas • **DE** Gas-griddleplatte glatt hartverchromt SUPERCHROME (Moca Approved), platte cm.55,5x55 - 2 Heizzonen • **FR** Plaque gaz lisse chromée SUPERCHROME (Moca Approved), plaque cm.55,5x55 - 2 zones de cuisson • **ES FRY-TOP GAS LISO CROMADO SUPERCHROME (MOCA APPROVED), PLANCHA CM.55,5X55 - 2 ZONAS DE COCCIÓN**
cm. 60x 65x 29h



⚡ 10,5 kW
9.030 kcal/h

2.915,00
65.5 / 0,27



FRY-TOP A GAS

MOD. _____
COD. _____

DESCRIZIONE/DESCRIPTION/BEZEICHNUNG/DESCRIPTION/DESCRIPCIÓN
DIMENSIONI/DIMENSIONS/ABMESSUNGEN/DIMENSIONS/DIMENSIONES

POTENZA/POWER/LEISTUNG/PUISSANCE/POTENCIA
VOLTAGGIO/VOLTAGE/SPANNUNG/VOLTAGE/VOLTAJE

kw kcal/h
kw kcal/h
V~ Hz

PREZZO/PRICE €
PREIS/PRIX/PRECIO €
KG / M³

FTLR-6G
07230652

Fry-top gas 1/2 rigato + 1/2 liscio, piastra cm.55,5x55 - 2 zone di cottura
EN Gas Fry-top 1/2 grooved + 1/2 smooth, plate cm.55,5x55 - 2 cooking areas • **DE** Gas-griddleplatte 1/2 gerillt + 1/2 glatt, platte cm.55,5x55 - 2 Heizzonen • **FR** Plaque gaz 1/2 nervurée + 1/2 lisse, plaque cm.55,5x55 - 2 zones de cuisson • **ES FRY-TOP GAS 1/2 ESTRIADO + 1/2 LISO, PLANCHA CM.55,5X55 - 2 ZONAS DE COCCIÓN**
cm. 60x 65x 29h



10,5 kW
9.030 kcal/h

2.411,00
65.5 / 0,27



FTLR-6GS
07230655

Fry-top gas 1/2 rigato + 1/2 liscio cromato SUPERCHROME (Moca Approved), piastra cm.55,5x55 - 2 zone di cottura
EN Gas Fry-top 1/2 grooved + 1/2 smooth chromed griddle SUPERCHROME (Moca Approved), plate cm.55,5x55 - 2 cooking areas • **DE** Gas-griddleplatte 1/2 gerillt + 1/2 glatt hartverchromt SUPERCHROME (Moca Approved), platte cm.55,5x55 - 2 Heizzonen • **FR** Plaque gaz 1/2 nervurée + 1/2 lisse chromée SUPERCHROME (Moca Approved), plaque cm.55,5x55 - 2 zones de cuisson • **ES FRY-TOP GAS 1/2 ESTRIADO + 1/2 LISO CROMADO SUPERCHROME (MOCA APPROVED), PLANCHA CM.55,5X55 - 2 ZONAS DE COCCIÓN**
cm. 60x 65x 29h

10,5 kW
9.030 kcal/h

3.110,00
65.5 / 0,27



FTR-6G
07230653

Fry-top gas rigato, piastra cm.55,5x55 - 2 zone di cottura
EN Gas Fry-top grooved griddle, plate cm.55,5x55 - 2 cooking areas • **DE** Gas-griddleplatte gerillt, platte cm.55,5x55 - 2 Heizzonen • **FR** Plaque gaz nervurée, plaque cm.55,5x55 - 2 zones de cuisson • **ES FRY-TOP GAS ESTRIADO, PLANCHA CM.55,5X55 - 2 ZONAS DE COCCIÓN**
cm. 60x 65x 29h

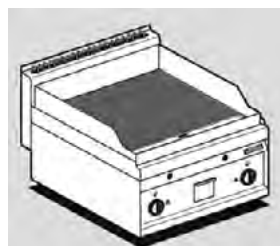

10,5 kW
9.030 kcal/h

2.609,00
65.5 / 0,27

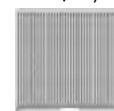

FTR-6GS
07230656

Fry-top gas rigato cromato SUPERCHROME (Moca Approved), piastra cm.55,5x55 - 2 zone di cottura
EN Gas Fry-top grooved chromed griddle SUPERCHROME (Moca Approved), plate cm.55,5x55 - 2 cooking areas • **DE** Gas-griddleplatte gerillt hartverchromt SUPERCHROME (Moca Approved), platte cm.55,5x55 - 2 Heizzonen • **FR** Plaque gaz nervurée chromée SUPERCHROME (Moca Approved), plaque cm.55,5x55 - 2 zones de cuisson • **ES FRY-TOP GAS ESTRIADO CROMADO SUPERCHROME (MOCA APPROVED), PLANCHA CM.55,5X55 - 2 ZONAS DE COCCIÓN**
cm. 60x 65x 29h

10,5 kW
9.030 kcal/h

3.304,00
65.5 / 0,27

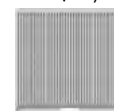

FTL-8G
07230851

Fry-top gas liscio, piastra cm.75,5x55 - 2 zone di cottura
EN Gas Fry-top smooth griddle, plate cm.75,5x55 - 2 cooking areas • **DE** Gas-griddleplatte glatt, platte cm.75,5x55 - 2 Heizzonen • **FR** Plaque gaz lisse, plaque cm.75,5x55 - 2 zones de cuisson • **ES FRY-TOP GAS LISO, PLANCHA CM.75,5X55 - 2 ZONAS DE COCCIÓN**
cm. 80x 65x 29h

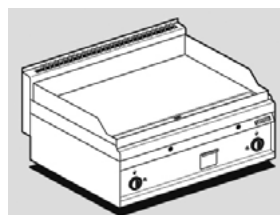

14 kW
12.040 kcal/h

3.485,00
84 / 0,35

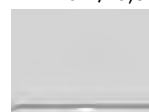

FTL-8GS
07230854

Fry-top gas liscio cromato SUPERCHROME (Moca Approved), piastra cm.75,5x55 - 2 zone di cottura
EN Gas Fry-top smooth chromed griddle SUPERCHROME (Moca Approved), plate cm.75,5x55 - 2 cooking areas • **DE** Gas-griddleplatte glatt hartverchromt SUPERCHROME (Moca Approved), platte cm.75,5x55 - 2 Heizzonen • **FR** Plaque gaz lisse chromée SUPERCHROME (Moca Approved), plaque cm.75,5x55 - 2 zones de cuisson • **ES FRY-TOP GAS LISO CROMADO SUPERCHROME (MOCA APPROVED), PLANCHA CM.75,5X55 - 2 ZONAS DE COCCIÓN**
cm. 80x 65x 29h

14 kW
12.040 kcal/h

4.436,00
84 / 0,35

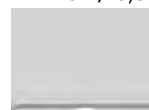

FTLR-8G
07230852

Fry-top gas 1/2 rigato + 1/2 liscio, piastra cm.75,5x55 - 2 zone di cottura
EN Gas Fry-top 1/2 grooved + 1/2 smooth, plate cm.75,5x55 - 2 cooking areas • **DE** Gas-griddleplatte 1/2 gerillt + 1/2 glatt, platte cm.75,5x55 - 2 Heizzonen • **FR** Plaque gaz 1/2 nervurée + 1/2 lisse, plaque cm.75,5x55 - 2 zones de cuisson • **ES FRY-TOP GAS 1/2 ESTRIADO + 1/2 LISO, PLANCHA CM.75,5X55 - 2 ZONAS DE COCCIÓN**
cm. 80x 65x 29h

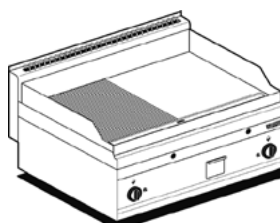

14 kW
12.040 kcal/h

3.681,00
84 / 0,35



FRY-TOP A GAS

MOD. _____
COD. _____

DESCRIZIONE/DESCRIPTION/BEZEICHNUNG/DESCRIPTION/DESCRIPCIÓN
DIMENSIONI/DIMENSIONS/ABMESSUNGEN/DIMENSIONS/DIMENSIONES

POTENZA/POWER/LEISTUNG/PUISSANCE/POTENCIA
VOLTAGGIO/VOLTAGE/SPANNUNG/VOLTAGE/VOLTAJE

kw kcal/h
kw V- Hz

PREZZO/PRICE €
PREIS/PRIX/PRECIO €
KG / M³

FTLR-8GS
07230855

Fry-top gas 1/2 rigato + 1/2 liscio cromato SUPERCHROME (Moca Approved, piastra cm.75,5x55 - 2 zone di cottura
EN Gas Fry-top 1/2 grooved + 1/2 smooth chromed griddle SUPERCHROME (Moca Approved), plate cm.75,5x55 - 2 cooking areas • **DE** Gas-griddleplatte 1/2 gerillt + 1/2 glatt hartverchromt SUPERCHROME (Moca Approved), platte cm.75,5x55 - 2 Heizzonen • **FR** Plaque gaz 1/2 nervurée + 1/2 lisse chromée SUPERCHROME (Moca Approved), plaque cm.75,5x55 - 2 zones de cuisson • **ES FRY-TOP GAS 1/2 ESTRIADO + 1/2 LISO CROMADO SUPERCHROME (MOCA APPROVED), PLANCHA CM.75,5X55 - 2 ZONAS DE COCCIÓN**
cm. 80x 65x 29h

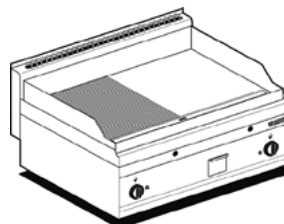

14 kW
12.040 kcal/h

4.654,00
84 / 0,35



PL-4
07010400

PIANO LAVORO Cassetto con 1 bacinella GN 1/1 15h plastica.
EN Worktop - Drawer with 1 plastic container GN 1/1 15h • **DE** Arbeitsplatte - Schublade mit 1 GN 1/1 15h Kunststoffbehälter • **FR** Plan de travail - tiroir avec bac en plastique GN 1/1 15h • **ES SOBRE DE TRABAJO - CAJÓN CON 1 CONTENEDOR GN 1/1 15H PLÁSTICO**
cm. 40x 65x 29h

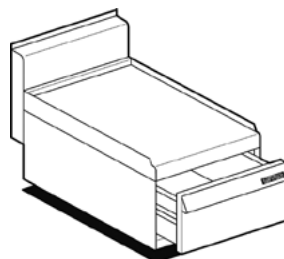

791,00
25 / 0,18

PL-6
07010600

PIANO LAVORO - Cassetto con 2 bacinelle: 1 GN 1/1 15h plastica, 1 cm. 17x46,5x15h inox.
EN Worktop - Drawer with 2 containers: 1 GN 1/1 15h plastic, 1 cm. 17x46,5x15h inox. • **DE** Arbeitsplatte - Schublade mit 2 Behältern: 1 GN 1/1 15h aus Kunststoff, 1 cm. 17x46,5x15h aus Edelstahl. • **FR** Plan de travail - tiroir avec 2 bacs: 1 GN 1/1 en plastique, 1 cm. 17x46,5x15h en acier inoxydable • **ES SOBRE DE TRABAJO - CAJÓN CON 2 CONTENEDORES: 1 GN 1/1 15H PLÁSTICO, 1 CM. 17X46,5X15H INOX**
cm. 60x 65x 29h



904,00
34 / 0,27

PL-8
07010800

PIANO LAVORO Cassetto con 2 bacinelle GN 1/1 15h plastica.
EN Worktop - Drawer with 2 plastic containers GN 1/1 15h • **DE** Arbeitsplatte - Schublade mit 2 GN 1/1 15h Kunststoffbehältern • **FR** Plan de travail - tiroir avec 2 bacs en plastique GN 1/1 15h • **ES SOBRE DE TRABAJO - CAJÓN CON 2 CONTENEDORES GN 1/1 15H PLÁSTICO**
cm. 80x 65x 29h



1.058,00
40 / 0,35

LA-6
07020600

LAVELLO Rubinetto a leva - Vasca cm. 40x40x15h
EN Sink unit - Lever type tap - Bowl cm. 40x40x15h • **DE** Spülbecken - Einhebel-Mischbatterie Becken cm. 40x40x15h • **FR** Bac-évier avec robinetterie - Bac cm. 40x40x15h • **ES FREGADERO - GRIFO A PALANCA - PILETA CM. 40X40X15H**
cm. 60x 65x 29h



1.078,00
25 / 0,27

M-4
07420400

MOBILE BASE A GIORNO
EN Open stand • **DE** Unterschrank offen • **FR** Placard ouvert • **ES MUEBLE BASE ABIERTO**
cm. 40x 53,5x 58h

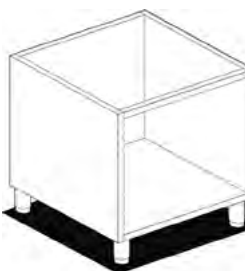

485,00
15 / 0,16

M-6
07420600

cm. 60x 53,5x 58h

679,00
19 / 0,24

M-8
07420800

cm. 80x 53,5x 58h

770,00
22 / 0,31

MOBILI BASE

MOD. COD.	DESCRIZIONE/DESCRIPTION/BEZEICHNUNG/DESCRIPTION/DESCRIPCIÓN DIMENSIONI/DIMENSIONS/ABMESSUNGEN/DIMENSIONS/DIMENSIONES	POTENZA/POWER/LEISTUNG/PUISSANCE/POTENCIA VOLTAGGIO/VOLTAGE/SPANNUNG/VOLTAGE/VOLTAJE	⊕kW kcal/h	⊖kW V~ Hz	PREZZO/PRICE € PREIS/PRIX/PRECIO € KG / M³
M-10 07421000	cm. 100x 53,5x 58h				1.111,00 27 / 0,39
M-12 07421200	cm. 120x 53,5x 58h				1.379,00 31 / 0,47
MPS-12 07421232	BASE CON PORTE SCORREVOLI EN Stand with sliding doors • DE Unterschrank mit Schiebetüren • FR Placard avec portes coulissantes • ES BASE CON PUERTAS CORREDIZAS cm. 120x 56,5x 58h				1.670,00 43 / 0,47
MPS-16 07421632	cm. 160x 56,5x 58h				1.888,00 60 / 0,73
MPS-20 07422032	cm. 200x 56,5x 58h				2.138,00 67 / 0,91
S-4 07410400	CAVALLETTO BASE EN Stand • DE Untergestell • FR Piement simple • ES SOPORTE BASE cm. 40x 53,5x 58h				455,00 19.5 / 0,16
S-6 07410600	cm. 60x 53,5x 58h				509,00 23 / 0,24
S-8 07410800	cm. 80x 53,5x 58h				600,00 26 / 0,31
S-10 07411000	cm. 100x 53,5x 58h				684,00 29 / 0,39
PM-3DX 07430300	PORTA 300 DX EN R/h door 300 • DE Flügeltür 300 rechts • FR Porte droite 300 • ES PUERTA 300 DERECHA cm. 29,5x 2,5x 45h				218,00 2.5 / 0,01
PM-4DX 07430400	PORTA 400 DX EN R/h door 400 • DE Flügeltür 400 rechts • FR Porte droite 400 • ES PUERTA 400 DERECHA cm. 39,5x 2,5x 45h				228,00 3.5 / 0,02
PM-3SX 07430301	PORTA 300 SX EN L/h door 300 • DE Flügeltür 300 links • FR Porte gauche 300 • ES PUERTA 300 IZQ. cm. 29,5x 2,5x 45h				218,00 2.5 / 0,01
PM-4SX 07430401	PORTA 400 SX EN L/h door 400 • DE Flügeltür 400 links • FR Porte gauche 400 • ES PUERTA 400 IZQ. cm. 39,5x 2,5x 45h				228,00 3.5 / 0,02

ACCESSORI

MOD. _____ DESCRIZIONE/DESCRIPTION/BEZEICHNUNG/DESCRIPTION/DESCRIPCIÓN POTENZA/POWER/LEISTUNG/PUISSANCE/POTENCIA ⚡kW ⚡kw PREZZO/PRICE €
 COD. _____ DIMENSIONI/DIMENSIONS/ABMESSUNGEN/DIMENSIONS/DIMENSIONES VOLTAGGIO/VOLTAGE/SPANNUNG/VOLTAGE/VOLTAJE kcal/h kcal/h V~ V~ PREIS/PRIX/PRECIO €
 KG / M³

C-4 07440420 CASSETTIERA 400 N. 2 cassetti con 2 bacinelle GN 1/1 15h in plastica, guide telescopiche.
EN Drawer set 400 - N. 2 drawers with 2 GN 1/1 15h plastic containers, telescopic guides • **DE** Schubladen 400 - N. 2 Schubladen mit 2 GN 1/1 15h Kunststoffbehältern Telescopeinführungen • **FR** Tiroirs pour meuble de 400 - N. 2 tiroirs avec 2 bacs en plastique GN 1/1 15h guides télescopiques • **ES CAJONERA 400 - N. 2 CAJONES CON 2 CONTENEDORES GN 1/1 15H DE PLÁSTICO, GUÍAS TELESCÓPICAS.**
cm. 39,5x 56x 45h

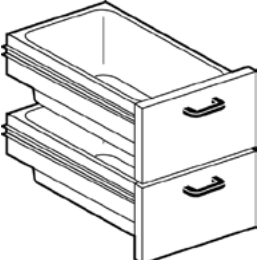

766,00
18 / 0,16

C-6 07440620 CASSETTIERA 600 - N. 2 cassetti con 4 bacinelle N. 2 GN 1/1 15h in plastica - N. 2 cm. 17x46,5x15h inox - Guide telescopiche.
EN Drawer set 600 - N. 2 drawers with 4 containers N. 2 GN 1/1 15h in plastic - N. 2 cm. 17x46,5x45h inox - Telescopic guides. • **DE** Schubladen 600 - N. 2 Schubladen mit 4 Behältern N. 2 GN 1/1 15h aus Kunststoff - N. 2 cm. 17x46,5x45h aus Edelstahl - Telescopeinführungen • **FR** Tiroirs pour meuble de 600 - N. 2 tiroirs avec 4 bacs: N. 2 GN 1/1 15h en plastique, N. 2 cm. 17x46,5x45h en acier inoxydable, guides télescopiques. • **ES CAJONERA 600 - N. 2 CAJONES CON 4 CONTENEDORES, N. 2 GN 1/1 15H DE PLÁSTICO, N. 2 CM17X46,5X45H INOX, GUÍAS TELESCÓPICAS.**
cm. 59,5x 56x 45h

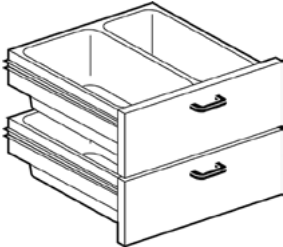

909,00
24 / 0,24

C-8 07440820 CASSETTIERA 800 N. 2 cassetti con 4 bacinelle GN 1/1 15h in plastica, guide telescopiche.
EN Drawer set 800 - N. 2 drawers with 4 GN 1/1 15h plastic containers, telescopic guides • **DE** Schubladen 800 - N. 2 Schubladen mit 4 GN 1/1 15h Kunststoffbehältern Telescopeinführungen • **FR** Tiroirs pour meuble de 800 - N. 2 tiroirs avec 4 bacs en plastique GN 1/1 15h guides télescopiques • **ES CAJONERA 800 - N. 2 CAJONES CON 4 CONTENEDORES GN 1/1 15H DE PLÁSTICO, GUÍAS TELESCÓPICAS.**
cm. 79,5x 56x 45h

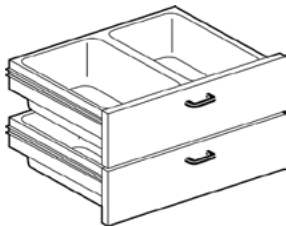

1.193,00
26 / 0,31

R-4 07450400 RIPIANO 400
EN Shelf 400 • **DE** Abstellbrett 400 • **FR** Etagère 400 • **ES ESTANTE 400**
cm. 35x 53x 2h



136,00
1.5 / 0,01

R-6 07450600 RIPIANO 600
EN Shelf 600 • **DE** Abstellbrett 600 • **FR** Etagère 600 • **ES ESTANTE 600**
cm. 55x 53x 2h



154,00
2 / 0,01

R-8 07450800 RIPIANO 800
EN Shelf 800 • **DE** Abstellbrett 800 • **FR** Etagère 800 • **ES ESTANTE 800**
cm. 75x 53x 2h



172,00
2.5 / 0,02

544023800 RASCHIETTO PER PIASTRA RIGATA
EN Scraper for gooved plate • **DE** Schaber für gerillte Kochplatte • **FR** Racleur pour plaque nervurée • **ES RASQUETA PARA PLACA RANURADA**





69,00
/ 1,00

CG-65 07560000 COPRIGIUNTO
EN Joint cover • **DE** Klemmsteg • **FR** Couvre-joint • **ES CUBRE JUNTA**
cm. 0,7x 58x 1,2h

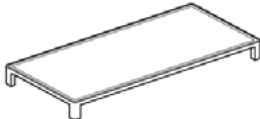
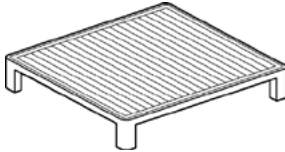

43,00
0.1 / 0,00

ACCESSORI

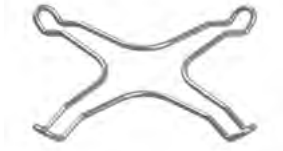
MOD. COD.	DESCRIZIONE/DESCRIPTION/BEZEICHNUNG/DESCRIPTION/DESCRIPCIÓN DIMENSIONI/DIMENSIONS/ABMESSUNGEN/DIMENSIONS/DIMENSIONES	POTENZA/POWER/LEISTUNG/PUISSANCE/POTENCIA VOLTAGGIO/VOLTAGE/SPANNUNG/VOLTAGE/VOLTAJE	$\frac{kW}{kcal/h}$ / $\frac{kW}{V-}$ Hz	PREZZO/PRICE PREIS/PRIX/PRECIO € KG / M ³
TG-4 07580400	TAGLIERE PLASTICA EN Plastic chopping-board • DE Schneidebrett • FR Plan de decoupe • ES PICADOR DE PLÁSTICO cm. 39x 58x 2,5h			170,00 6 / 0,01
TG-6 07580600	cm. 59x 58x 2,5h			251,00 9 / 0,02
TG-8 07580800	cm. 79x 58x 2,5h			324,00 11 / 0,02
TG-10 07581000	cm. 99x 58x 2,5h			349,00 14 / 0,02
06290600	Coperchio (BR-6) EN Lid (BR-6) • DE Deckel (BR-6) • FR Couvercle (BR-6) • ES TAPA (BR-6) cm. 51x 42x 3h			150,00 3 / 0,02
PLF 07590401	PIASTRA LISCIA per GRIGLIA IN GHISA EN Smooth griddle plate for cast iron grid • DE Fortkochplatte glatt für Gusseisen Rost • FR Plaque lisse pour la grille en fonte • ES PLANCHA LISA PARA REJILLA DE HIERRO FUNDIDO cm. 35x 27			205,00 9 / 0,01
PLF/2 07590421	PIASTRA LISCIA 2 FUOCHI per GRIGLIA IN GHISA EN Smooth griddle plate 2 burners for cast iron grid • DE Fortkochplatte glatt 2 Kochstellen für Gusseisen Rost • FR Plaque lisse 2 feux pour la grille en fonte • ES PLANCHA LISA 2 QUEMADORES PARA REJILLA DE HIERRO FUNDIDO cm. 35x 57			405,00 18 / 0,01
PRF 07590403	PIASTRA RIGATA per GRIGLIA IN GHISA EN Grooved griddle plate for cast iron grid • DE Fortkochplatte gerillt für Gusseisen Rost • FR Plaque nervurée pour la grille en fonte • ES PLANCHA ESTRIADA PARA REJILLA DE HIERRO FUNDIDO cm. 35x 27			274,00 9 / 0,01
PRF/2 07590423	PIASTRA RIGATA 2 FUOCHI per GRIGLIA IN GHISA EN Grooved griddle plate 2 burners for cast iron grid • DE Fortkochplatte gerillt 2 Kochstellen für Gusseisen Rost • FR Plaque nervurée 2 feux pour la grille en fonte • ES PLANCHA ESTRIADA 2 QUEMADORES PARA REJILLA DE HIERRO FUNDIDO cm. 35x 57			450,00 18 / 0,01
533009200	GRIGLIA DI RIDUZIONE EN Reduction • DE Reduzierstern • FR Grille de réduction • ES REJILLA DE REDUCCIÓN cm. 25x 25			43,00 0,2 / 0,00

ACCESSORI

MOD. _____ DESCRIZIONE/DESCRIPTION/BEZEICHNUNG/DESCRIPTION/DESCRIPCIÓN POTENZA/POWER/LEISTUNG/PUISSANCE/POTENCIA ⚡kW ⚡kw PREZZO/PRICE €
 COD. _____ DIMENSIONI/DIMENSIONS/ABMESSUNGEN/DIMENSIONS/DIMENSIONES VOLTAGGIO/VOLTAGE/SPANNUNG/VOLTAGE/VOLTAJE kcal/h V~ Hz PREIS/PRIX/PRECIO €
 KG / M³

544439900 ANELLO PER WOK - solo per griglie in ghisa
EN Wok ring - only for cast iron grills • **DE** Wok Aufsatzring - nur für Roste aus Gusseisen • **FR** Anneau Wok - seulement pour grilles en fonte
• ES ANILLO WOK - SOLO PARA PARRILAS DE HIERRO COLADO
cm. Ø 22,5x 3,5h



170,00
2 / 0,00

D-8 DIVISORIO Necessario per applicare cassetiera C-4 su mobile M-8
07470000 **EN** Partition - for installation of a C-4 on a stand M-8 • **DE** Trennwand - Um ein C-4 an einem Unterschrank M-8 einzubauen • **FR** Separation - Pour l'installation de C-4 sur placard M-8 • **ES DIVISORIO - NECESARIO PARA APLICAR CAJONERAS C-4 EN MUEBLE M-8**
cm. 5x 53,5x 38,5h

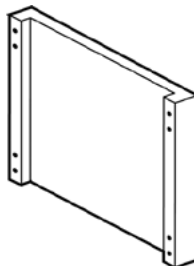

172,00
2 / 0,02

PT PORTATEGLIE VANO 400/600 (GN-1/1) 4 ripiani int. 9 cm.
07460002 **EN** Frame for plates 400/600 (GN-1/1) - N. 4 shelves, wheel-base 9 cm. • **DE** Aufhängeschienen für bleche 400/600 (GN-1/1) N. 4 Etagen, Abstand 9 cm. • **FR** Kit porte-plaques 400/600 (GN-1/1) - N. 4 étagères; 9 cm. • **ES PORTACAZUELAS 400/600 (GN-1/1) - N. 4 ESTANTES, INT. 9 CM.**

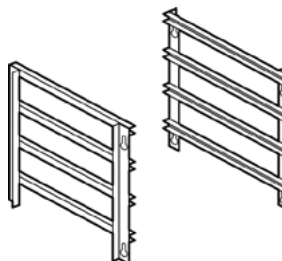

492,00
2 / 0,01

07570400 Griglia per carni grasse regolabile (CW-4)
EN Adjustable grill for meat (CW-4) • **DE** Einstellbarer Fleischrost (CW-4) • **FR** Grille cannelée à gorges, réglable (CW-4) • **ES PARRILLA PARA CARNES GRASAS REGULABLE (CW-4)**
cm. 38x 47



269,00
2.5 / 0,03

06300600 Griglia per carni grasse regolabile (CW-6)
EN Adjustable grill for meat (CW-6) • **DE** Einstellbare Fleischrost (CW-6) • **FR** Grille cannelée réglable à gorges (CW-6) • **ES PARRILLA PARA CARNES GRASAS REGULABLE (CW-6)**
cm. 28x 47

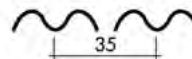

261,00
2 / 0,02

531048000 CESTO 1/6 PER CPM-6G
EN Basket 1/6 for CPM-6G • **DE** Korb 1/6 für CPM-6G • **FR** Panier 1/6 pour CPM-6G • **ES CESTA 1/6 PARA CPM-6G**
cm. 13,5x 16x 21,5h



102,00
1 / 0,02

531064300 CESTO 1/4 PER CPM-6G
EN Basket 1/4 for CPM-6G • **DE** Korb 1/4 für CPM-6G • **FR** Panier 1/4 pour CPM-6G • **ES CESTA 1/4 PARA CPM-6G**
cm. 11,5x 29x 20h

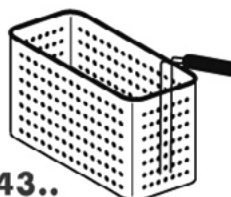

130,00
1,2 / 0,04

.643..

ACCESSORI CUOCIPASTA

MOD. COD.	DESCRIZIONE/DESCRIPTION/BEZEICHNUNG/DESCRIPTION/DESCRIPCIÓN DIMENSIONI/DIMENSIONS/ABMESSUNGEN/DIMENSIONS/DIMENSIONES	POTENZA/POWER/LEISTUNG/PUISSANCE/POTENCIA VOLTAGGIO/VOLTAGE/SPANNUNG/VOLTAGE/VOLTAJE	kw kcal/h	kw V~ Hz	PREZZO/PRICE € PREIS/PRIX/PRECIO KG / M³
531018700	CESTO CON GANCIO 1/4 PER CPM-6G EN Basket with hook 1/4 for CPM-6G • DE Korb mit Haken 1/4 für CPM-6G • FR Panier avec crochet 1/4 pour CPM-6G • ES CESTA CON GANCHO 1/4 PARA CPM-6G cm. 11x 26x 20h				131,00 1,2 / 0,04
531069500	SUPPORTO PER CESTI CON GANCIO PER CPM-6G EN support for baskets with hook for CPM-6G • DE Unterstützung für Körbe mit Haken für CPM-6G • FR soutien pour les paniers avec crochet pour CPM-6G • ES SOPORTE PARA CESTAS CON GANCHO PARA CPM-6G cm. 50x 29x 39h				195,00 4 / 0,08
531043900	Cesto 1/1 (FP-6E) EN basket 1/1 (FP-6E) • DE Fritierkorb 1/1 (FP-6E) • FR Panier 1/1 (FP-6E) • ES CESTA 1/1 (FP-6E) cm. 46x 30x 10h				170,00 3 / 0,06
531024300	Cesto 1/1 (FP-6G) EN basket 1/1 (FP-6G) • DE Fritierkorb 1/1 (FP-6G) • FR Panier 1/1 (FP-6G) • ES CESTA 1/1 (FP-6G) cm. 42,5x 31x 10h				167,00 3 / 0,06
531013200	Cesto 1/2 (FQ-4-6) 1/4 (FP-6E) EN basket 1/2 (FQ-4-6) 1/4 (FP-6E) • DE Fritierkorb 1/2 (FQ-4-6) 1/4 (FP-6E) • FR Panier 1/2 (FQ-4-6) 1/4 (FP-6E) • ES CESTA 1/2 (FQ-4-6) 1/4 (FP-6E) cm. 10x 30x 12h				63,00 0.7 / 0,03
531013500	Cesto 1/2 (FQM-4G) EN basket 1/2 (FQM-4G) • DE Fritierkorb 1/2 (FQM-4G) • FR Panier 1/2 (FQM-4G) • ES CESTA 1/2 (FQM-4G) cm. 14x 33x 12h				77,00 0.8 / 0,04
06280600	Scivolo (FP-6E) EN Slide (FP-6E) • DE Rutsche (FP-6E) • FR Goulotte (FP-6E) • ES DESLIZADOR (FP-6E) cm. 60x 34				157,00 4 / 0,05
07600600	Scivolo (FP-6G) EN Slide (FP-6G) • DE Rutsche (FP-6G) • FR Goulotte (FP-6G) • ES DESLIZADOR (FP-6G) cm. 55x 34				154,00 4 / 0,05
FU-1X7 05281700	FORMA PER UOVA Ø 7 EN Egg poachers Ø 7 • DE Eierformer Ø 7 • FR Forme a oeuf Ø 7 • ES MOLDE PARA HUEVOS Ø 7				23,00 1 / 0,00
FU-1X9 05281900	FORMA PER UOVA Ø 9 EN Egg poachers Ø 9 • DE Eierformer Ø 9 • FR Forme a oeuf Ø 9 • ES MOLDE PARA HUEVOS Ø 9				27,00 1 / 0,00

ACCESSORI

MOD. COD.	DESCRIZIONE/DESCRIPTION/BEZEICHNUNG/DESCRIPTION/DESCRIPCIÓN DIMENSIONI/DIMENSIONS/ABMESSUNGEN/DIMENSIONS/DIMENSIONES	POTENZA/POWER/LEISTUNG/PUISSANCE/POTENCIA VOLTAGGIO/VOLTAGE/SPANNUNG/VOLTAGE/VOLTAGE	⚡kW kcal/h	⚡kw V~ Hz	PREZZO/PRICE PREIS/PRIX/PRECIO € KG / M³
FU-2X7 05282700	FORMA PER UOVA 2xØ 7 EN Egg poachers Ø 7 • DE Eierformer Ø 7 • FR Forme a oeuf Ø 7 • ES MOLDE PARA HUEVOS Ø 7				38,00 1.5 / 0,00
FU-2X9 05282900	FORMA PER UOVA 2xØ 9 EN Egg poachers Ø 9 • DE Eierformer Ø 9 • FR Forme a oeuf Ø 9 • ES MOLDE PARA HUEVOS Ø 9				43,00 1.5 / 0,00
FU-3X7 05283700	FORMA PER UOVA 3xØ 7 EN Egg poachers Ø 7 • DE Eierformer Ø 7 • FR Forme a oeuf Ø 7 • ES MOLDE PARA HUEVOS Ø 7				51,00 2 / 0,00
FU-3X9 05283900	FORMA PER UOVA 3xØ 9 EN Egg poachers Ø 9 • DE Eierformer Ø 9 • FR Forme a oeuf Ø 9 • ES MOLDE PARA HUEVOS Ø 9				54,00 2 / 0,00





70

لوتس®

CUCINE ELETTRICHE

MOD. _____
COD. _____

DESCRIZIONE/DESCRIPTION/BEZEICHNUNG/DESCRIPTION/DESCRIPCIÓN
DIMENSIONI/DIMENSIONS/ABMESSUNGEN/DIMENSIONS/DIMENSIONES

POTENZA/POWER/LEISTUNG/PUISSANCE/POTENCIA
VOLTAGGIO/VOLTAGE/SPANNUNG/VOLTAGE/VOLTAJE

⚡ kW
kcal/h

⚡ kw
V-
Hz

PREZZO/PRICE €
PREIS/PRIX/PRECIO
KG / M³

CF4-78ET
08660830

CUCINA 4 piastre - Forno elettrico statico cm. 67x55x34h, temp: 50÷300°C, con 1 griglia cm.65x53 GN2/1 (inclusa 1 testata chiusura piano mod.TPA-7)
EN Electric range - N. 4 plates Traditional electric oven cm. 67x55x34h, temp: 50÷300°C, with 1 grid cm.65x53 GN2/1 (included 1 Head end filler strip mod.TPA-7) • **DE** Elektroherd - N. 4 Kochplatten Statischer Elektro-Backofen cm. 67x55x34h, temp: 50÷300°C, mit 1 Rost cm.65x53 GN2/1 (inbegriffen 1 Abschluss-Element mod.TPA-7) • **FR** Fourneau électrique - N. 4 plaques Four électrique statique cm. 67x55x34h, temp: 50÷300°C avec 1 grille cm.65x53 GN2/1 (inclus 1 Élément de jonction top mod.TPA-7) • **ES COCINA ELÉCTRICA - N. 4 PLANCHAS HORNO ELÉCTRICO ESTÁTICO CM. 67X55X34H, TEMP: 50÷300°C, CON 1 PARILLA CM.65X53 GN2/1 (INCLUIDA 1 CHAPA DE CIERRE PARA TOP MOD.TPA-7) cm. 80x 70,5x 90h**



⚡ 15,4 kW
400V~3N
50/60 Hz

3.957,00
112 / 0,71

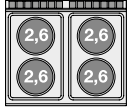

CFV4-78ET
08660835

CUCINA 4 piastre - Forno elettrico ventilato cm. 55x36x34h, temp: 50÷300°C, con 1 griglia cm.53x32,5 GN1/1 (inclusa 1 testata chiusura piano mod.TPA-7)
EN Electric range - N. 4 plates - electric fan oven cm. 55x36x34h, temp: 50÷300°C, with 1 grid cm.53x32,5 GN1/1 (included 1 Head end filler strip mod.TPA-7) • **DE** Elektroherd - N. 4 Kochplatten - Elektro-Heißluftofen cm. 55x36x34h, temp: 50÷300°C, mit 1 Rost cm.53x32,5 GN1/1 (inbegriffen 1 Abschluss-Element mod.TPA-7) • **FR** Fourneau électrique - N. 4 plaques Four à chaleur tournante électrique cm. 55x36x34h, temp: 50÷300°C avec 1 grille cm.53x32,5 GN1/1 (inclus 1 Élément de jonction top mod.TPA-7) • **ES COCINA ELÉCTRICA - N. 4 PLANCHAS - HORNO ELÉCTRICO VENTILADO CM. 55X36X34H, TEMP: 50÷300°C, CON 1 PARILLA CM.53X32,5 GN1/1 (INCLUIDA 1 CHAPA DE CIERRE PARA TOP MOD. TPA-7) cm. 80x 70,5x 90h**

⚡ 15,72 kW
400V~3N
50/60 Hz

4.430,00
112 / 0,71

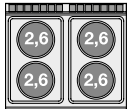

CFQ4-78ET
08660831

CUCINA 4 piastre quadre - Forno elettrico statico cm. 67x55x34h, temp: 50÷300°C, con 1 griglia cm.65x53 GN2/1 (inclusa 1 testata chiusura piano mod.TPA-7)
EN Electric range - N. 4 square plates Traditional electric oven cm. 67x55x34h, temp: 50÷300°C, with 1 grid cm.65x53 GN2/1 (included 1 Head end filler strip mod.TPA-7) • **DE** Elektroherd - N. 4 quadratischen Platten - Statischer Elektro-Backofen cm. 67x55x34h, temp: 50÷300°C, mit 1 Rost cm.65x53 GN2/1 (inbegriffen 1 Abschluss-Element mod.TPA-7) • **FR** Fourneau électrique - N. 4 plaques carrés - Four électrique statique cm. 67x55x34h, temp: 50÷300°C avec 1 grille cm.65x53 GN2/1 (inclus 1 Élément de jonction top mod.TPA-7) • **ES COCINA ELÉCTRICA - N. 4 PLANCHAS CUADRADAS HORNO ELÉCTRICO ESTÁTICO CM. 67X55X34H, TEMP: 50÷300°C, CON 1 PARILLA CM.65X53 GN2/1 (INCLUIDA 1 CHAPA DE CIERRE PARA TOP MOD. TPA-7) cm. 80x 70,5x 90h**



⚡ 15,4 kW
400V~3N
50/60 Hz

5.114,00
120 / 0,71

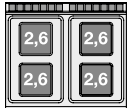

CFVQ4-78ET
08660836

CUCINA 4 piastre quadre - Forno elettrico ventilato cm. 55x36x34h, temp: 50÷300°C, con 1 griglia cm.53x32,5 GN1/1 (inclusa 1 testata chiusura piano mod.TPA-7)
EN Electric range - N. 4 square plates - electric fan oven cm. 55x36x34h, temp: 50÷300°C, with 1 grid cm.53x32,5 GN1/1 (included 1 Head end filler strip mod.TPA-7) • **DE** Elektroherd - N. 4 quadratischen Platten - Elektro-Heißluftofen cm. 55x36x34h, temp: 50÷300°C, mit 1 Rost cm.53x32,5 GN1/1 (inbegriffen 1 Abschluss-Element mod. TPA-7) • **FR** Fourneau électrique - N. 4 plaques carrés - Four à chaleur tournante électrique cm. 55x36x34h, temp: 50÷300°C avec 1 grille cm.53x32,5 GN1/1 (inclus 1 Élément de jonction top mod.TPA-7) • **ES COCINA ELÉCTRICA - N. 4 PLANCHAS CUADRADAS HORNO ELÉCTRICO VENTILADO CM. 55X36X34H, TEMP: 50÷300°C, CON 1 PARILLA CM.53X32,5 GN1/1 (INCLUIDA 1 CHAPA DE CIERRE PARA TOP MOD.TPA-7) cm. 80x 70,5x 90h**

⚡ 15,72 kW
400V~3N
50/60 Hz

5.557,00
120 / 0,71

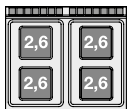

CUCINE ELETTRICHE

MOD. _____
COD. _____

DESCRIZIONE/DESCRIPTION/BEZEICHNUNG/DESCRIPTION/DESCRIPCIÓN
DIMENSIONI/DIMENSIONS/ABMESSUNGEN/DIMENSIONS/DIMENSIONES

POTENZA/POWER/LEISTUNG/PUISSANCE/POTENCIA
VOLTAGGIO/VOLTAGE/SPANNUNG/VOLTAGE/VOLTAJE

⚡ kcal/h
kw

⚡ V~
Hz

PREZZO/PRICE €
PREIS/PRIX/PRECIO
KG / M³

CFC4-78ET
08660832

CUCINA 4 piastre vetroceramica cm. 75 x 57 - Forno elettrico statico cm. 67x55x34h, temp: 50÷300°C, con 1 griglia cm.65x53 GN2/1 (inclusa 1 testata chiusura piano mod.TPA-7)

EN Electric range N. 4 plates ceramic glass cm. 75 x 57 - traditional electric oven cm. 67x55x34h, temp: 50÷300°C, with 1 grid cm.65x53 GN2/1 (included 1 Head end filler strip mod.TPA-7) • **DE** Elektroherd N. 4 Ceran-Kochplatten cm. 75 x 57 - Statischer Elektro-Backofen cm. 67x55x34h, temp: 50÷300°C, mit 1 Rost cm.65x53 GN2/1 (inbegriffen 1 Abschluss-Element mod.TPA-7) • **FR** Fourneau électrique N. 4 plaques vitroceramique cm. 75 x 57 - Four électrique statique cm. 67x55x34h, temp: 50÷300°C avec 1 grille cm.65x53 GN2/1 (inclus 1 Élément de jonction top mod.TPA-7) • **ES COCINA ELÉCTRICA N. 4 PLANCHAS VITROCERÁMICA CM. 75 X 57 - HORNO ELÉCTRICO ESTÁTICO CM. 67X55X34H, TEMP: 50÷300°C, CON 1 PARILLA CM.65X53 GN2/1 (INCLUIDA 1 CHAPA DE CIERRE PARA TOP MOD.TPA-7)**

cm. 80x 70,5x 90h



⚡ 15 kW
400V~3N
50/60 Hz

5.607,00
107 / 0,71

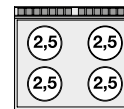

CFVC4-78ET
08660837

CUCINA 4 piastre vetroceramica cm. 75 x 57 - Forno elettrico ventilato cm. 55x36x34h, temp: 50÷300°C, con 1 griglia cm.53x32,5 GN1/1 (inclusa 1 testata chiusura piano mod.TPA-7)

EN Electric range N. 4 plates ceramic glass cm. 75 x 57 - electric fan oven cm. 55x36x34h, temp: 50÷300°C, with 1 grid cm.53x32,5 GN1/1 (included 1 Head end filler strip mod.TPA-7) • **DE** Elektroherd N. 4 Ceran-Kochplatten cm. 75 x 57 - Elektro-Heißluftofen cm. 55x36x34h, temp: 50÷300°C, mit 1 Rost cm.53x32,5 GN1/1 (inbegriffen 1 Abschluss-Element mod.TPA-7) • **FR** Fourneau électrique N. 4 plaques vitroceramique cm. 75 x 57 - Four à chaleur tournante électrique cm. 55x36x34h, temp: 50÷300°C avec 1 grille cm.53x32,5 GN1/1 (inclus 1 Élément de jonction top mod.TPA-7) • **ES COCINA ELÉCTRICA N. 4 PLANCHAS VITROCERÁMICA CM. 75 X 57 - HORNO ELÉCTRICO VENTILADO CM. 55X36X34H, TEMP: 50÷300°C, CON 1 PARILLA CM.53X32,5 GN1/1 (INCLUIDA 1 CHAPA DE CIERRE PARA TOP MOD.TPA-7)**

cm. 80x 70,5x 90h

⚡ 15,32 kW
400V~3N
50/60 Hz

6.033,00
107 / 0,71

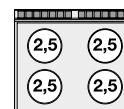

CF4-78GP
08680850

CUCINA 4 fuochi - Forno a gas statico cm. 67x55x34h, temp: 150÷300°C, con 1 griglia cm.65x53 GN2/1 (inclusa 1 testata chiusura piano mod.TPA-7)

EN Gas Range - N. 4 burners Traditional gas-oven cm. 67x55x34h, temp: 150÷300°C, with 1 grid cm.65x53 GN2/1 (included 1 Head end filler strip mod.TPA-7) • **DE** Gasherd - N. 4 Kochstellen Statischer Gas-Backofen cm. 67x55x34h, temp: 150÷300°C, mit 1 Rost cm.65x53 GN2/1 (inbegriffen 1 Abschluss-Element mod.TPA-7) • **FR** Cuisiniere gaz - N. 4 feux vifs Four à gaz statique cm. 67x55x34h, temp: 150÷300°C avec 1 grille cm.65x53 GN2/1 (inclus 1 Élément de jonction top mod.TPA-7) • **ES COCINA A GAS - N. 4 QUEMADORES HORNO A GAS ESTÁTICO CM. 67X55X34H, TEMP: 150÷300°C, CON 1 PARILLA CM.65X53 GN2/1 (INCLUIDA 1 CHAPA DE CIERRE PARA TOP MOD.TPA-7)**

cm. 80x 70,5x 90h



⚡ 29,3 kW
25.198 kcal/h

4.523,00
138 / 0,71

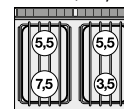

CF4-78GPE
08690860

CUCINA 4 fuochi - Forno elettrico statico cm. 67x55x34h, temp: 50÷300°C, con 1 griglia cm.65x53 GN2/1 (inclusa 1 testata chiusura piano mod.TPA-7)

EN Gas Range - N. 4 burners - traditional electric oven cm. 67x55x34h, temp: 50÷300°C, with 1 grid cm.65x53 GN2/1 (included 1 Head end filler strip mod.TPA-7) • **DE** Gasherd - N. 4 Kochstellen Statischer Elektro-Backofen cm. 67x55x34h, temp: 50÷300°C, mit 1 Rost cm.65x53 GN2/1 (inbegriffen 1 Abschluss-Element mod.TPA-7) • **FR** Cuisiniere gaz - N. 4 feux vifs Four électrique statique cm. 67x55x34h, temp: 50÷300°C avec 1 grille cm.65x53 GN2/1 (inclus 1 Élément de jonction top mod.TPA-7) • **ES COCINA A GAS - N. 4 QUEMADORES HORNO ELÉCTRICO ESTÁTICO CM. 67X55X34H, TEMP: 50÷300°C, CON 1 PARILLA CM.65X53 GN2/1 (INCLUIDA 1 CHAPA DE CIERRE PARA TOP MOD.TPA-7)**

cm. 80x 70,5x 90h



⚡ 22 kW
18.920 kcal/h

4.523,00
132 / 0,71

⚡ 5 kW
400V~3N
50/60 Hz

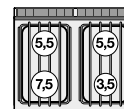

CUCINE A GAS CON FORNO ELETTRICO

MOD. _____
COD. _____

DESCRIZIONE/DESCRIPTION/BEZEICHNUNG/DESCRIPTION/DESCRIPCIÓN
DIMENSIONI/DIMENSIONS/ABMESSUNGEN/DIMENSIONS/DIMENSIONES

POTENZA/POWER/LEISTUNG/PUISSANCE/POTENCIA
VOLTAGGIO/VOLTAGE/SPANNUNG/VOLTAGE/VOLTAJE

⚡ kW kcal/h
⚡ kW V~ Hz

PREZZO/PRICE
PREIS/PRIX/PRECIO €
KG / M³

CFV4-78GPE CUCINA 4 fuochi - Forno elettrico ventilato cm. 55x36x34h, temp: 50÷300°C, con 1 griglia cm.53x32,5 GN1/1 (inclusa 1 testata chiusura piano mod.TPA-7)
EN Gas Range - N. 4 burners - electric fan oven cm. 55x36x34h, temp: 50÷300°C, with 1 grid cm.53x32,5 GN1/1 (included 1 Head end filler strip mod.TPA-7) • **DE** Gasherd - N. 4 Kochstellen Elektro-Heißluftofen cm. 55x36x34h, temp: 50÷300°C, mit 1 Rost cm.53x32,5 GN1/1 (inbegriffen 1 Abschluss-Element mod.TPA-7) • **FR** Cuisiniere gaz - N. 4 feux vifs Four à chaleur tournante électrique cm. 55x36x34h, temp: 50÷300°C avec 1 grille cm.53x32,5 GN1/1 (inclus 1 Élément de jonction top mod.TPA-7) • **ES COCINA A GAS - N. 4 QUEMADORES HORNO ELÉCTRICO VENTILADO CM. 55X36X34H, TEMP: 50÷300°C, CON 1 PARILLA CM.53X32,5 GN1/1 (INCLUIDA 1 CHAPA DE CIERRE PARA TOP MOD.TPA-7) cm. 80x 70,5x 90h**



⚡ 22 kW 4.958,00
18.920 kcal/h 132 / 0,71

⚡ 5,32 kW
400V~3N
230V~3
50/60 Hz

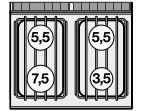

CFA4-78GP CUCINA ACQUA 4 fuochi - Forno a gas statico cm. 67x55x34h, temp: 150÷300°C, con 1 griglia cm.65x53 GN2/1 - Rubinetto carico acqua, sfioratore (inclusa 1 testata chiusura piano mod.TPA-7)
EN Water range - N. 4 burners Traditional gas-oven cm. 67x55x34h, temp: 150÷300°C, with 1 grid cm.65x53 GN2/1 - Water loading tap + overflow device (included 1 Head end filler strip mod.TPA-7) • **DE** Wasser herd - N. 4 Kochstellen Statischer Gas-Backofen cm. 67x55x34h, temp: 150÷300°C, mit 1 Rost cm.65x53 GN2/1 - Wasserlauf-Hahn + Überlauf-Vorrichtung (inbegriffen 1 Abschluss-Element mod.TPA-7) • **FR** Cuisinière l'eau - N. 4 feux vifs Four à gaz statique cm. 67x55x34h, temp: 150÷300°C avec 1 grille cm.65x53 GN2/1 - Robinet d'arrivée d'eau trop plein (inclus 1 Élément de jonction top mod.TPA-7) • **ES COCINA A AGUA - N. 4 QUEMADORES HORNO A GAS ESTÁTICO CM. 67X55X34H, TEMP: 150÷300°C, CON 1 PARILLA CM.65X53 GN2/1 - GRIFO CARGA AGUA + VERTEDERO (INCLUIDA 1 CHAPA DE CIERRE PARA TOP MOD.TPA-7) cm. 80x 70,5x 90h**



⚡ 35,3 kW 6.292,00
30.358 kcal/h 138 / 0,71

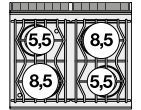

CF6-712ETV CUCINA 6 piastre - Forno elettrico statico cm. 67x55x34h, temp: 50÷300°C, con 1 griglia cm.65x53 GN2/1 - Vano neutro con porta (inclusa 1 testata chiusura piano mod.TPA-7)
EN Electric range - N. 6 plates Traditional electric oven cm. 67x55x34h, temp: 50÷300°C, with 1 grid cm.65x53 GN2/1 - Neutral cabinet with door (included 1 Head end filler strip mod.TPA-7) • **DE** Elektroherd - N. 6 Kochplatten Statischer Elektro-Backofen cm. 67x55x34h, temp: 50÷300°C, mit 1 Rost cm.65x53 GN2/1 - Neutrales Schrankelement mit Tür (inbegriffen 1 Abschluss-Element mod.TPA-7) • **FR** Fourneau électrique - N. 6 plaques Four électrique statique cm. 67x55x34h, temp: 50÷300°C avec 1 grille cm.65x53 GN2/1 - Element neutre avec porte (inclus 1 Élément de jonction top mod.TPA-7) • **ES COCINA ELÉCTRICA - N. 6 PLANCHAS HORNO ELÉCTRICO ESTÁTICO CM. 67X55X34H, TEMP: 50÷300°C, CON 1 PARILLA CM.65X53 GN2/1 - ARMARIO NEUTRO CON PUERTA (INCLUIDA 1 CHAPA DE CIERRE PARA TOP MOD.TPA-7) cm. 120x 70,5x 90h**



⚡ 20,6 kW 5.275,00
400V~3N 134 / 1,05
50/60 Hz



CFV6-712ETV CUCINA 6 piastre - Forno elettrico ventilato cm. 55x36x34h, temp: 50÷300°C, con 1 griglia cm.53x32,5 GN1/1 - Vano neutro con porta (inclusa 1 testata chiusura piano mod.TPA-7)
EN Electric range - N. 6 plates electric fan oven cm. 55x36x34h, temp: 50÷300°C, with 1 grid cm.53x32,5 GN1/1 - Neutral cabinet with door (included 1 Head end filler strip mod.TPA-7) • **DE** Elektroherd - N. 6 Kochplatten Elektro-Heißluftofen cm. 55x36x34h, temp: 50÷300°C, mit 1 Rost cm.53x32,5 GN1/1 - Neutrales Schrankelement mit Tür (inbegriffen 1 Abschluss-Element mod.TPA-7) • **FR** Fourneau électrique - N. 6 plaques Four à chaleur tournante électrique cm. 55x36x34h, temp: 50÷300°C avec 1 grille cm.53x32,5 GN1/1 - Element neutre avec porte (inclus 1 Élément de jonction top mod.TPA-7) • **ES COCINA ELÉCTRICA - N. 6 PLANCHAS HORNO ELÉCTRICO VENTILADO CM. 55X36X34H, TEMP: 50÷300°C, CON 1 PARILLA CM.53X32,5 GN1/1 - ARMARIO NEUTRO CON PUERTA (INCLUIDA 1 CHAPA DE CIERRE PARA TOP MOD.TPA-7) cm. 120x 70,5x 90h**

⚡ 20,92 kW 5.696,00
400V~3N 134 / 1,05
50/60 Hz

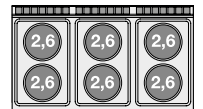

CUCINE ELETTRICHE

MOD. _____
COD. _____

DESCRIZIONE/DESCRIPTION/BEZEICHNUNG/DESCRIPTION/DESCRIPCIÓN
DIMENSIONI/DIMENSIONS/ABMESSUNGEN/DIMENSIONS/DIMENSIONES

POTENZA/POWER/LEISTUNG/PUISSANCE/POTENCIA
VOLTAGGIO/VOLTAGE/SPANNUNG/VOLTAGE/VOLTAJE

⚡ kW kcal/h
⚡ kw V~ Hz

PREZZO/PRICE €
PREIS/PRIX/PRECIO
KG / M³

CFQ6-712ETV CUCINA 6 piastre quadre - Forno elettrico statico cm. 67x55x34h, temp: 50÷300°C, con 1 griglia cm.65x53 GN2/1 - Vano neutro con porta (inclusa 1 testata chiusura piano mod.TPA-7)
08661231

EN Electric range - N. 6 square plates Traditional electric oven cm. 67x55x34h, temp: 50÷300°C, with 1 grid cm.65x53 GN2/1 - Neutral cabinet with door (included 1 Head end filler strip mod.TPA-7) • **DE** Elektroherd - N. 6 quadratischen Platten Statischer Elektro-Backofen cm. 67x55x34h, temp: 50÷300°C, mit 1 Rost cm.65x53 GN2/1 - Neutrales Schrankelement mit Tür (inbegriffen 1 Abschluss-Element mod.TPA-7) • **FR** Fourneau électrique - N. 6 plaques carrés Four électrique statique cm. 67x55x34h, temp: 50÷300°C avec 1 grille cm.65x53 GN2/1 - Element neutre avec porte (inclus 1 Élément de jonction top mod.TPA-7) • **ES COCINA ELÉCTRICA - N. 6 PLANCHAS CUADRADAS HORNO ELÉCTRICO ESTÁTICO CM. 67X55X34H, TEMP: 50÷300°C, CON 1 PARILLA CM.65X53 GN2/1 - ARMARIO NEUTRO CON PUERTA (INCLUIDA 1 CHAPA DE CIERRE PARA TOP MOD.TPA-7) cm. 120x 70,5x 90h**



⚡ 20,6 kW **7.064,00**
400V~3N 146 / 1,05
50/60 Hz

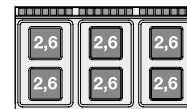

CFVQ6-712ETV CUCINA 6 piastre quadre - Forno elettrico ventilato cm. 55x36x34h, temp: 50÷300°C, con 1 griglia cm.53x32,5 GN1/1 - Vano neutro con porta (inclusa 1 testata chiusura piano mod.TPA-7)
08661236

EN Electric range - N. 6 square plates electric fan oven cm. 55x36x34h, temp: 50÷300°C, with 1 grid cm.53x32,5 GN1/1 - Neutral cabinet with door (included 1 Head end filler strip mod.TPA-7) • **DE** Elektroherd - N. 6 quadratischen Platten Elektro-Heißluftofen cm. 55x36x34h, temp: 50÷300°C, mit 1 Rost cm.53x32,5 GN1/1 - Neutrales Schrankelement mit Tür (inbegriffen 1 Abschluss-Element mod.TPA-7) • **FR** Fourneau électrique - N. 6 plaques carrés Four à chaleur tournante électrique cm. 55x36x34h, temp: 50÷300°C avec 1 grille cm.53x32,5 GN1/1 - Element neutre avec porte (inclus 1 Élément de jonction top mod.TPA-7) • **ES COCINA ELÉCTRICA - N. 6 PLANCHAS CUADRADAS HORNO ELÉCTRICO VENTILADO CM. 55X36X34H, TEMP: 50÷300°C, CON 1 PARILLA CM.53X32,5 GN1/1 - ARMARIO NEUTRO CON PUERTA (INCLUIDA 1 CHAPA DE CIERRE PARA TOP MOD.TPA-7) cm. 120x 70,5x 90h**

⚡ 20,92 kW **7.482,00**
400V~3N 146 / 1,05
50/60 Hz



CF6-712ET CUCINA 6 piastre Forno elettrico statico cm. 107x55x34h, temp: 50÷300°C, con 1 griglia cm.105x53 (inclusa 1 testata chiusura piano mod.TPA-7)
08661232

EN Electric Range - N. 6 plates Traditional electric oven cm. 107x55x34h, temp: 50÷300°C, with 1 grid cm.105x53 (included 1 Head end filler strip mod.TPA-7) • **DE** Elektroherd - N. 6 Kochplatten Statischer Elektro-Backofen cm. 107x55x34h, temp: 50÷300°C, mit 1 Rost cm.105x53 (inbegriffen 1 Abschluss-Element mod.TPA-7) • **FR** Fourneau électrique - N. 6 plaques Four électrique statique cm. 107x55x34h, temp: 50÷300°C, avec 1 grille cm.105x53 (inclus 1 Élément de jonction top mod.TPA-7) • **ES COCINA ELÉCTRICA - N. 6 PLANCHAS HORNO ELÉCTRICO ESTÁTICO CM. 107X55X34H, TEMP: 50÷300°C, CON 1 PARILLA CM.105X53 (INCLUIDA 1 CHAPA DE CIERRE PARA TOP MOD.TPA-7) cm. 120x 70,5x 90h**



⚡ 22,5 kW **5.950,00**
400V~3N 136 / 1,05
50/60 Hz

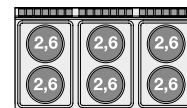

CFQ6-712ET CUCINA 6 piastre quadre Forno elettrico statico cm. 107x55x34h, temp: 50÷300°C, con 1 griglia cm.105x53 (inclusa 1 testata chiusura piano mod.TPA-7)
08661233

EN Electric Range - N. 6 square plates Traditional electric oven cm. 107x55x34h, temp: 50÷300°C, with 1 grid cm.105x53 (included 1 Head end filler strip mod.TPA-7) • **DE** Elektroherd - N. 6 quadratischen Platten Statischer Elektro-Backofen cm. 107x55x34h, temp: 50÷300°C, mit 1 Rost cm.105x53 (inbegriffen 1 Abschluss-Element mod.TPA-7) • **FR** Fourneau électrique - N. 6 plaques carrés Four électrique statique cm. 107x55x34h, temp: 50÷300°C, avec 1 grille cm.105x53 (inclus 1 Élément de jonction top mod.TPA-7) • **ES COCINA ELÉCTRICA - N. 6 PLANCHAS CUADRADAS HORNO ELÉCTRICO ESTÁTICO CM. 107X55X34H, TEMP: 50÷300°C, CON 1 PARILLA CM.105X53 (INCLUIDA 1 CHAPA DE CIERRE PARA TOP MOD. TPA-7) cm. 120x 70,5x 90h**



⚡ 22,5 kW **7.637,00**
400V~3N 148 / 1,05
50/60 Hz

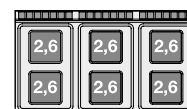

CUCINE A GAS

MOD. _____
COD. _____

DESCRIZIONE/DESCRIPTION/BEZEICHNUNG/DESCRIPTION/DESCRIPCIÓN
DIMENSIONI/DIMENSIONS/ABMESSUNGEN/DIMENSIONS/DIMENSIONES

POTENZA/POWER/LEISTUNG/PUISSANCE/POTENCIA
VOLTAGGIO/VOLTAGE/SPANNUNG/VOLTAGE/VOLTAJE

⚡ kW _____
kcal/h _____
V~ _____
Hz _____

PREZZO/PRICE
PREIS/PRIX/PRECIO €
KG / M³

CF6-712GPV CUCINA 6 fuochi Forno a gas statico cm. 67x55x34h, temp: 150÷300°C, con 1 griglia cm.65x53 GN2/1 - Vano neutro con porta (inclusa 1 testata chiusura piano mod.TPA-7)
EN Gas Range - N. 6 burners Traditional gas-oven GN cm. 67x55x34h, temp: 150÷300°C, with 1 grid cm.65x53 GN2/1 - Neutral cabinet with door (included 1 Head end filler strip mod.TPA-7) • **DE** Gasherd - N. 6 Kochstellen - Statischer Gas-Backofen cm. 67x55x34h, temp: 150÷300°C, mit 1 Rost cm.65x53 GN2/1 - Neutrales Schrankelement mit Tür (inbegriffen 1 Abschluss-Element mod.TPA-7) • **FR** Cuisiniere Gaz - N. 6 feux vifs Four à gaz statique cm. 67x55x34h, temp: 150÷300°C avec 1 grille cm.65x53 GN2/1 - Élément neutre avec porte (inclus 1 Élément de jonction top mod.TPA-7) • **ES COCINA A GAS - N. 6 QUEMADORES HORNO A GAS ESTÁTICO CM. 67X55X34H, TEMP: 150÷300°C, CON 1 PARILLA CM.65X53 GN2/1 - ARMARIO NEUTRO CON PUERTA (INCLUIDA 1 CHAPA DE CIERRE PARA TOP MOD.TPA-7)**
cm. 120x 70,5x 90h



⚡ 42,3 kW _____ **6.024,00**
36.378 kcal/h _____ 178 / 1,05

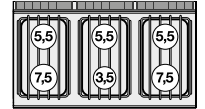

CF6-712GPEV CUCINA 6 fuochi - Forno elettrico statico cm. 67x55x34h, temp: 50÷300°C, con 1 griglia cm.65x53 GN2/1 - Vano neutro con porta (inclusa 1 testata chiusura piano mod.TPA-7)
EN Gas Range - N. 6 burners - traditional electric oven cm. 67x55x34h, temp: 50÷300°C, with 1 grid cm.65x53 GN2/1 - Neutral cabinet with door (included 1 Head end filler strip mod.TPA-7) • **DE** Gasherd - N. 6 Kochstellen Statischer Elektro-Backofen cm. 67x55x34h, temp: 50÷300°C, mit 1 Rost cm.65x53 GN2/1 - Neutrales Schrankelement mit Tür (inbegriffen 1 Abschluss-Element mod.TPA-7) • **FR** Cuisiniere gaz - N. 6 feux vifs Four électrique statique cm. 67x55x34h, temp: 50÷300°C avec 1 grille cm.65x53 GN2/1 - Element neutre avec porte (inclus 1 Élément de jonction top mod.TPA-7) • **ES COCINA A GAS - N. 6 QUEMADORES HORNO ELÉCTRICO ESTÁTICO CM. 67X55X34H, TEMP: 50÷300°C, CON 1 PARILLA CM.65X53 GN2/1 - ARMARIO NEUTRO CON PUERTA (INCLUIDA 1 CHAPA DE CIERRE PARA TOP MOD.TPA-7)**
cm. 120x 70,5x 90h



⚡ 35 kW _____ **6.024,00**
30.100 kcal/h _____ 177 / 1,05

⚡ 5 kW _____
400V~3N _____
50/60 Hz _____

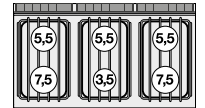

CFV6-712GPEV CUCINA 6 fuochi - Forno elettrico ventilato cm. 55x36x34h, temp: 50÷300°C, con 1 griglia cm.53x32,5 GN1/1 - Vano neutro con porta (inclusa 1 testata chiusura piano mod.TPA-7)
EN Gas Range - N. 6 burners - electric fan oven cm. 55x36x34h, temp: 50÷300°C, with 1 grid cm.53x32,5 GN1/1 - Neutral cabinet with door (included 1 Head end filler strip mod.TPA-7) • **DE** Gas Range - N. 6 burners - electric fan oven cm. 55x36x34h, temp: 50÷300°C, mit 1 Rost cm.53x32,5 GN1/1 - Neutral cabinet with door (inbegriffen 1 Abschluss-Element mod.TPA-7) • **FR** Gas Range - N. 6 burners - electric fan oven cm. 55x36x34h, temp: 50÷300°C avec 1 grille cm.53x32,5 GN1/1 - Neutral cabinet with door (inclus 1 Élément de jonction top mod.TPA-7) • **ES GAS RANGE - N. 6 BURNERS - ELECTRIC FAN OVEN CM. 55X36X34H, TEMP: 50÷300°C, CON 1 PARILLA CM.53X32,5 GN1/1 - NEUTRAL CABINET WITH DOOR (INCLUIDA 1 CHAPA DE CIERRE PARA TOP MOD.TPA-7)**
cm. 120x 70,5x 90h

⚡ 35 kW _____ **6.426,00**
30.100 kcal/h _____ 177 / 1,05

⚡ 5,32 kW _____
400V~3N _____
230V~3 _____
50/60 Hz _____

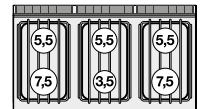

CFA6-712GPV CUCINA ACQUA 6 fuochi - Forno a gas statico cm. 67x55x34h, temp: 150÷300°C, con 1 griglia cm.65x53 GN2/1 - Vano neutro con porta - Rubinetto carico acqua, sfioratore (inclusa 1 testata chiusura piano mod. TPA-7)
EN Water range - N. 6 burners - Traditional gas-oven cm. 67x55x34h, temp: 150÷300°C, with 1 grid cm.65x53 GN2/1 - Neutral cabinet with door - Water loading tap + overflow device (included 1 Head end filler strip mod.TPA-7) • **DE** Wasser herd - N. 6 Kochstellen - Statischer Gas-Backofen cm. 67x55x34h, temp: 150÷300°C, mit 1 Rost cm.65x53 GN2/1 - Neutrales Schrankelement mit Tür - Wasserlauf-Hahn + Überlauf-Vorrichtung (inbegriffen 1 Abschluss-Element mod.TPA-7) • **FR** Cuisiniere l'eau - N. 6 feux vifs Four à gaz statique cm. 67x55x34h, temp: 150÷300°C avec 1 grille cm.65x53 GN2/1 - Element neutre avec porte - Robinet d'arrivée d'eau trop plein (inclus 1 Élément de jonction top mod. TPA-7) • **ES COCINA A AGUA N. 6 QUEMADORES HORNO A GAS ESTÁTICO CM. 67X55X34H, TEMP: 150÷300°C, CON 1 PARILLA CM.65X53 GN2/1 - ARMARIO NEUTRO CON PUERTA - GRIFO CARGA AGUA + VERTEDERO (INCLUIDA 1 CHAPA DE CIERRE PARA TOP MOD.TPA-7)**
cm. 120x 70,5x 90h



⚡ 49,3 kW _____ **7.313,00**
42.398 kcal/h _____ 178 / 1,05

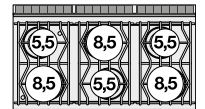

CUCINE A GAS

MOD. _____
COD. _____

DESCRIZIONE/DESCRIPTION/BEZEICHNUNG/DESCRIPTION/DESCRIPCIÓN
DIMENSIONI/DIMENSIONS/ABMESSUNGEN/DIMENSIONS/DIMENSIONES

POTENZA/POWER/LEISTUNG/PUISSANCE/POTENCIA
VOLTAGGIO/VOLTAGE/SPANNUNG/VOLTAGE/VOLTAJE

⚡ kW
kcal/h

⚡ kW
V~
Hz

PREZZO/PRICE €
PREIS/PRIX/PRECIO €
KG / M³

CF6-712GP CUCINA 6 fuochi Forno a gas statico cm. 107x55x34h, temp: 150÷300°C, con 1 griglia cm.105x53 (inclusa 1 testata chiusura piano mod.TPA-7)
08681250
EN Gas Range - N. 6 burners Traditional gas-oven cm. 107x55x34h, temp: 150÷300°C, with 1 grid cm.105x53 (included 1 Head end filler strip mod.TPA-7) • **DE** Gasherd - N. 6 Kochstellen Statischer Gas-Backofen cm. 107x55x34h, temp: 150÷300°C, mit 1 Rost cm.105x53 (inbegriffen 1 Abschluss-Element mod.TPA-7) • **FR** Cuisiniere gaz - N. 6 feux vifs Four à gaz statique cm. 107x55x34h, temp: 150÷300°C, avec 1 grille cm.105x53 (inclus 1 Élément de jonction top mod.TPA-7) • **ES COCINA A GAS - N. 6 QUEMADORES HORNO A GAS ESTÁTICO CM. 107X55X34H, TEMP: 150÷300°C, CON 1 PARILLA CM.105X53 (INCLUIDA 1 CHAPA DE CIERRE PARA TOP MOD.TPA-7)**
cm. 120x 70,5x 90h



⚡ 46 kW
39.560 kcal/h

6.737,00
197 / 1,05

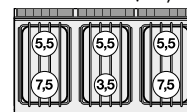

CF6-712GPE CUCINA 6 fuochi Forno elettrico statico cm. 107x55x34h, temp: 50÷300°C, con 1 griglia cm.105x53 (inclusa 1 testata chiusura piano mod.TPA-7)
08691260
EN Gas Range - N. 6 burners Traditional electric oven cm. 107x55x34h, temp: 50÷300°C, with 1 grid cm.105x53 (included 1 Head end filler strip mod.TPA-7) • **DE** Gasherd - N. 6 Kochstellen Statischer Elektro-Backofen cm. 107x55x34h, temp: 50÷300°C, mit 1 Rost cm.105x53 (inbegriffen 1 Abschluss-Element mod.TPA-7) • **FR** Cuisiniere gaz - N. 6 feux vifs Four électrique statique cm. 107x55x34h, temp: 50÷300°C, avec 1 grille cm.105x53 (inclus 1 Élément de jonction top mod.TPA-7) • **ES COCINA A GAS - N. 6 QUEMADORES HORNO ELÉCTRICO ESTÁTICO CM. 107X55X34H, TEMP: 50÷300°C, CON 1 PARILLA CM.105X53 (INCLUIDA 1 CHAPA DE CIERRE PARA TOP MOD.TPA-7)**
cm. 120x 70,5x 90h



⚡ 35 kW
30.100 kcal/h

6.737,00
190 / 1,05

⚡ 6,9 kW
400V~3N
50/60 Hz

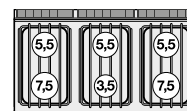

PC-74ET PIANO COTTURA TRIFASE SU MOBILE A GIORNO - N. 2 piastre (inclusa 1 testata chiusura piano mod.TPA-7)
08030430
EN Boiling unit threephase on open cabinet - N. 2 plates (included 1 Head end filler strip mod.TPA-7) • **DE** Kochplatte dreiphasig mit offenem Unterbau N. 2 Kochplatten (inbegriffen 1 Abschluss-Element mod.TPA-7) • **FR** Rechaud électriques sur armoire ouvert - N. 2 plaques (inclus 1 Élément de jonction top mod.TPA-7) • **ES SOBRE DE COCCIÓN TRIFÁSICO SOBRE MUEBLE ABIERTO N. 2 PLANCHAS (INCLUIDA 1 CHAPA DE CIERRE PARA TOP MOD.TPA-7)**
cm. 40x 70,5x 90h



⚡ 5,2 kW
400V~2N
230V~3
230V~
50/60 Hz

1.328,00
42 / 0,37



PC-78ET PIANO COTTURA TRIFASE SU MOBILE A GIORNO N. 4 piastre (inclusa 1 testata chiusura piano mod.TPA-7)
08030830
EN Threephase boiling unit on open cabinet - N. 4 plates (included 1 Head end filler strip mod.TPA-7) • **DE** Kochplatte dreiphasig mit offenem Unterbau N. 4 Kochplatten (inbegriffen 1 Abschluss-Element mod.TPA-7) • **FR** Rechaud triphase sur armoire ouvert - N. 4 plaques (inclus 1 Élément de jonction top mod.TPA-7) • **ES SOBRE DE COCCIÓN TRIFÁSICO SOBRE MUEBLE ABIERTO N. 4 PLANCHAS (INCLUIDA 1 CHAPA DE CIERRE PARA TOP MOD.TPA-7)**
cm. 80x 70,5x 90h



⚡ 10,4 kW
400V~3N
230V~3
50/60 Hz

2.043,00
68 / 0,71

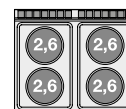

PC-712ET PIANO COTTURA TRIFASE SU MOBILE A GIORNO N. 6 piastre (inclusa 1 testata chiusura piano mod.TPA-7)
08031230
EN Threephase boiling unit on open cabinet - N. 6 plates (included 1 Head end filler strip mod.TPA-7) • **DE** Kochplatte dreiphasig mit offenem Unterbau N. 6 Kochplatten (inbegriffen 1 Abschluss-Element mod.TPA-7) • **FR** Rechaud triphase sur armoire ouvert - N. 6 plaques (inclus 1 Élément de jonction top mod.TPA-7) • **ES SOBRE DE COCCIÓN TRIFÁSICO SOBRE MUEBLE ABIERTO N. 6 PLANCHAS (INCLUIDA 1 CHAPA DE CIERRE PARA TOP MOD.TPA-7)**
cm. 120x 70,5x 90h



⚡ 15,6 kW
400V~3N
230V~3
50/60 Hz

2.839,00
88 / 1,05

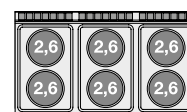

PIANI COTTURA ELETTRICI

MOD. _____
COD. _____

DESCRIZIONE/DESCRIPTION/BEZEICHNUNG/DESCRIPTION/DESCRIPCIÓN
DIMENSIONI/DIMENSIONS/ABMESSUNGEN/DIMENSIONS/DIMENSIONES

POTENZA/POWER/LEISTUNG/PUISSANCE/POTENCIA
VOLTAGGIO/VOLTAGE/SPANNUNG/VOLTAGE/VOLTAGE

⚡ kW _____
kcal/h _____
V~ _____
Hz _____

PREZZO/PRICE
PREIS/PRIX/PRECIO €
KG / M³

PCQ-74ET
08030431

PIANO COTTURA TRIFASE SU MOBILE A GIORNO - N. 2 piastre quadre (inclusa 1 testata chiusura piano mod.TPA-7)
EN Boiling unit threephase on open cabinet - N. 2 square plates (included 1 Head end filler strip mod.TPA-7) • **DE** Kochplatte dreiphasig mit offenem Unterbau N. 2 quadratischen Platten (inbegriffen 1 Abschluss-Element mod.TPA-7) • **FR** Rechaud électriques sur armoire ouvert - N. 2 plaques carrés (inclus 1 Élément de jonction top mod.TPA-7) • **ES SOBRE DE COCCIÓN TRIFÁSICO SOBRE MUEBLE ABIERTO N. 2 PLANCHAS CUADRADAS (INCLUIDA 1 CHAPA DE CIERRE PARA TOP MOD.TPA-7)**
cm. 40x 70,5x 90h



⚡ 5,2 kW _____ **1.983,00**
400V~2N _____ 46 / 0,37
230V~3 _____
230V~ _____
50/60 Hz _____



PCQ-78ET
08030831

PIANO COTTURA TRIFASE SU MOBILE A GIORNO - N. 4 piastre quadre (inclusa 1 testata chiusura piano mod.TPA-7)
EN Boiling unit threephase on open cabinet - N. 4 square plates (included 1 Head end filler strip mod.TPA-7) • **DE** Kochplatte dreiphasig mit offenem Unterbau N. 4 quadratischen Platten (inbegriffen 1 Abschluss-Element mod.TPA-7) • **FR** Rechaud électriques sur armoire ouvert - N. 4 plaques carrés (inclus 1 Élément de jonction top mod.TPA-7) • **ES SOBRE DE COCCIÓN TRIFÁSICO SOBRE MUEBLE ABIERTO N. 4 PLANCHAS CUADRADAS (INCLUIDA 1 CHAPA DE CIERRE PARA TOP MOD.TPA-7)**
cm. 80x 70,5x 90h



⚡ 10,4 kW _____ **3.444,00**
400V~3N _____ 71 / 0,71
230V~3 _____
50/60 Hz _____

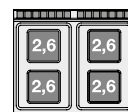

PCQ-712ET
08031231

PIANO COTTURA TRIFASE SU MOBILE A GIORNO - N. 6 piastre quadre (inclusa 1 testata chiusura piano mod.TPA-7)
EN Boiling unit threephase on open cabinet - N. 6 square plates (included 1 Head end filler strip mod.TPA-7) • **DE** Kochplatte dreiphasig mit offenem Unterbau N. 6 quadratischen Platten (inbegriffen 1 Abschluss-Element mod.TPA-7) • **FR** Rechaud électriques sur armoire ouvert - N. 6 plaques carrés (inclus 1 Élément de jonction top mod.TPA-7) • **ES SOBRE DE COCCIÓN TRIFÁSICO SOBRE MUEBLE ABIERTO N. 6 PLANCHAS CUADRADAS (INCLUIDA 1 CHAPA DE CIERRE PARA TOP MOD.TPA-7)**
cm. 120x 70,5x 90h



⚡ 15,6 kW _____ **4.910,00**
400V~3N _____ 103 / 1,05
230V~3 _____
50/60 Hz _____

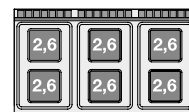

PCC-74ET
08030432

PIANO COTTURA VETROCERAMICA TRIFASE su mobile a giorno - N. 2 zone - vetro cm.35x57 (inclusa 1 testata chiusura piano mod.TPA-7)
EN Ceramic glass boiling unit on open cabinet - n. 2 zones - glass cm.35x57 (included 1 Head end filler strip mod.TPA-7) • **DE** Ceran-Kochplatte dreiphasig mit offenem Unterbau - 2 zonen - Glas 35x57 cm (inbegriffen 1 Abschluss-Element mod.TPA-7) • **FR** Plan de cuisson à vitroceramique triphasé sur armoire ouvert N. 2 zones - Verre cm.35x57 (inclus 1 Élément de jonction top mod.TPA-7) • **ES SOBRE DE COCCIÓN TRIFÁSICO VITROCERÁMICA SOBRE MUEBLE ABIERTO - 2 ZONAS - VIDRO CM.35X57 (INCLUIDA 1 CHAPA DE CIERRE PARA TOP MOD.TPA-7)**
cm. 40x 70,5x 90h

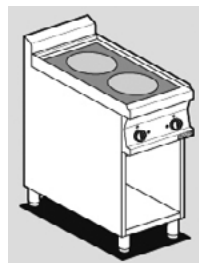

⚡ 5 kW _____ **2.469,00**
400V~2N _____ 41 / 0,37
230V~3 _____
230V~ _____
50/60 Hz _____

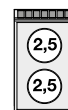

PCC-78ET
08030832

PIANO COTTURA VETROCERAMICA TRIFASE su mobile a giorno - N. 4 zone - vetro cm. 75x57 (inclusa 1 testata chiusura piano mod.TPA-7)
EN Ceramic glass boiling unit on open cabinet - n. 4 zones - glass cm. 75 x 57 (included 1 Head end filler strip mod.TPA-7) • **DE** Ceran-Kochplatte dreiphasig mit offenem Unterbau - 4 zonen - Glas 75x57 cm (inbegriffen 1 Abschluss-Element mod.TPA-7) • **FR** Plan de cuisson à vitroceramique triphasé sur armoire ouvert N. 4 zones - Verre cm 75x57 (inclus 1 Élément de jonction top mod.TPA-7) • **ES SOBRE DE COCCIÓN TRIFÁSICO VITROCERÁMICA SOBRE MUEBLE ABIERTO - 4 ZONAS - VIDRO CM. 75 X 57 (INCLUIDA 1 CHAPA DE CIERRE PARA TOP MOD.TPA-7)**
cm. 80x 70,5x 90h



⚡ 10 kW _____ **3.632,00**
400V~3N _____ 66 / 0,71
230V~3 _____
50/60 Hz _____

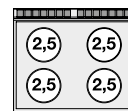

PCI-74ET
08030433

PIANO COTTURA INDUZIONE TRIFASE - N. 2 zone - Vetro cm.35x57 (inclusa 1 testata chiusura piano mod.TPA-7)
EN Three-phase induction cooking - 2 zones - glass cm.35x57 (included 1 Head end filler strip mod.TPA-7) • **DE** Induktions-Kochplatte dreiphasig - 2 zonen - Glas 35x57 cm (inbegriffen 1 Abschluss-Element mod.TPA-7) • **FR** Plan de cuisson à induction triphasé N. 2 zones - Verre cm.35x57 (inclus 1 Élément de jonction top mod.TPA-7) • **ES ENCIMERA INDUCCIÓN TRIFÁSICA - 2 ZONAS - VIDRIO CM.35X57 (INCLUIDA 1 CHAPA DE CIERRE PARA TOP MOD.TPA-7)**
cm. 40x 70,5x 90h



⚡ 10 kW _____ **8.640,00**
400V~3 _____ 40 / 0,37
50/60 Hz _____

PIANI COTTURA A INDUZIONE

MOD. _____ DESCRIZIONE/DESCRIPTION/BEZEICHNUNG/DESCRIPTION/DESCRIPCIÓN POTENZA/POWER/LEISTUNG/PUISSANCE/POTENCIA ⚡ kW ⚡ kw PREZZO/PRICE €
 COD. _____ DIMENSIONI/DIMENSIONS/ABMESSUNGEN/DIMENSIONS/DIMENSIONES VOLTAGGIO/VOLTAGE/SPANNUNG/VOLTAGE/VOLTAGE kcal/h V~ Hz PREIS/PRIX/PRECIO €
 KG / M³

PCIW-74ET PIANO COTTURA INDUZIONE TRIFASE "WOK" - N. 1 zona - Vetro Ø 30 cm. (inclusa 1 testata chiusura piano mod.TPA-7)
 08030434 **EN** Three-phase induction cooking "WOK" - 1 zone - glass Ø 30 cm (included 1 Head end filler strip mod.TPA-7) • **DE** Induktions-Kochplatte "WOK" dreiphasig - 1 zonen - Glas Ø 30 cm (inbegriffen 1 Abschluss-Element mod.TPA-7) • **FR** Plan de cuisson à induction "WOK" triphasé N. 1 zone - Verre cm Ø 30 (inclus 1 Élément de jonction top mod.TPA-7) • **ES ENCIMERA INDUCCIÓN "WOK" TRIFÁSICA - 1 ZONA - VIDRIO Ø 30 CM (INCLUIDA 1 CHAPA DE CIERRE PARA TOP MOD.TPA-7)**
cm. 40x 70,5x 90h



⚡ 5 kW **6.590,00**
 400V~3 38 / 0,37
 50/60 Hz

PCI-78ET PIANO COTTURA INDUZIONE TRIFASE - N. 4 zone - Vetro cm.75x57 (inclusa 1 testata chiusura piano mod.TPA-7)
 08030833 **EN** Three-phase induction cooking - 4 zones - glass cm.75x57 (included 1 Head end filler strip mod.TPA-7) • **DE** Induktions-Kochplatte dreiphasig - 4 zonen - Glas 75x57 cm (inbegriffen 1 Abschluss-Element mod.TPA-7) • **FR** Plan de cuisson à induction triphasé N. 4 zones - Verre cm.75x57 (inclus 1 Élément de jonction top mod.TPA-7) • **ES ENCIMERA INDUCCIÓN TRIFÁSICA - 4 ZONAS - VIDRIO CM.75X57 (INCLUIDA 1 CHAPA DE CIERRE PARA TOP MOD.TPA-7)**
cm. 80x 70,5x 90h

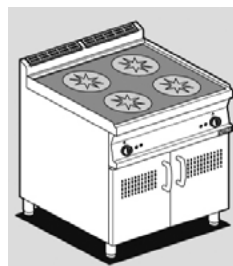

⚡ 20 kW **16.419,00**
 400V~3 70 / 0,71
 50/60 Hz

PC-74GP PIANO COTTURA GAS SU MOBILE A GIORNO 2 fuochi (inclusa 1 testata chiusura piano mod.TPA-7)
 08210450 **EN** Gas heated boiling unit on open cabinet - 2 burners (included 1 Head end filler strip mod.TPA-7) • **DE** Gas-kochplatte mit offenem Unterbau - 2 Kochstellen (inbegriffen 1 Abschluss-Element mod.TPA-7) • **FR** Rechaud gaz sur armoire ouvert - 2 feux vifs (inclus 1 Élément de jonction top mod.TPA-7) • **ES SOBRES DE COCCIÓN GAS SOBRE MUEBLE ABIERTO - 2 QUEMADORES (INCLUIDA 1 CHAPA DE CIERRE PARA TOP MOD.TPA-7)**
cm. 40x 70,5x 90h



⚡ 13 kW **1.865,00**
 11.180 kcal/h 63 / 0,37

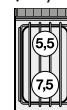

PIANI COTTURA A GAS

MOD. _____
COD. _____

DESCRIZIONE/DESCRIPTION/BEZEICHNUNG/DESCRIPTION/DESCRIPCIÓN
DIMENSIONI/DIMENSIONS/ABMESSUNGEN/DIMENSIONS/DIMENSIONES

POTENZA/POWER/LEISTUNG/PUISSANCE/POTENCIA
VOLTAGGIO/VOLTAGE/SPANNUNG/VOLTAGE/VOLTAJE

kw / kcal/h
V- Hz

PREZZO/PRICE €
PREIS/PRIX/PRECIO
KG / M³

PC-78GP
08210850

PIANO COTTURA GAS SU MOBILE A GIORNO 4 fuochi (inclusa 1 testata chiusura piano mod.TPA-7)

EN Gas heated boiling unit on open cabinet - 4 burners (included 1 Head end filler strip mod.TPA-7) • **DE** Gas-Kochplatte mit offenem Unterbau - 4 Kochstellen (inbegriffen 1 Abschluss-Element mod.TPA-7) • **FR** Rechaud gaz sur armoire ouvert - 4 feux vifs (inclus 1 Élément de jonction top mod.TPA-7) • **ES SOBRES DE COCCIÓN GAS SOBRE MUEBLE ABIERTO - 4 QUEMADORES (INCLUIDA 1 CHAPA DE CIERRE PARA TOP MOD.TPA-7)**
cm. 80x 70,5x 90h



22 kW / 18.920 kcal/h
2.983,00 € / 76 / 0,71

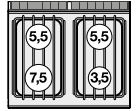

PC-712GP
08211250

PIANO COTTURA GAS SU MOBILE A GIORNO 6 fuochi (inclusa 1 testata chiusura piano mod.TPA-7)

EN Gas heated boiling unit on open cabinet - 6 burners (included 1 Head end filler strip mod.TPA-7) • **DE** Gas-Kochplatte mit offenem Unterbau - 6 Kochstellen (inbegriffen 1 Abschluss-Element mod.TPA-7) • **FR** Rechaud gaz sur armoire ouvert - 6 feux vifs (inclus 1 Élément de jonction top mod.TPA-7) • **ES SOBRES DE COCCIÓN GAS SOBRE MUEBLE ABIERTO - 6 QUEMADORES (INCLUIDA 1 CHAPA DE CIERRE PARA TOP MOD.TPA-7)**
cm. 120x 70,5x 90h



35 kW / 30.100 kcal/h
4.272,00 € / 126 / 1,05

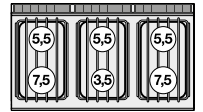

PC1-74G
08210453

PIANO COTTURA GAS SU MOBILE A GIORNO 1 fuochi (inclusa 1 testata chiusura piano mod.TPA-7)

EN Gas heated boiling unit on open cabinet - 1 burners (included 1 Head end filler strip mod.TPA-7) • **DE** Gas-kochplatte mit offenem Unterbau - 1 Kochstellen (inbegriffen 1 Abschluss-Element mod.TPA-7) • **FR** Rechaud gaz sur armoire ouvert - 1 feux vifs (inclus 1 Élément de jonction top mod.TPA-7) • **ES SOBRES DE COCCIÓN GAS SOBRE MUEBLE ABIERTO - 1 QUEMADORES (INCLUIDA 1 CHAPA DE CIERRE PARA TOP MOD.TPA-7)**
cm. 40x 70,5x 90h



10 kW / 8.600 kcal/h
1.907,00 € / 63 / 0,37

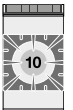

PC2-78G
08210853

PIANO COTTURA GAS SU MOBILE A GIORNO 2 fuochi (inclusa 1 testata chiusura piano mod.TPA-7)

EN Gas heated boiling unit on open cabinet - 2 burners (included 1 Head end filler strip mod.TPA-7) • **DE** Gas-kochplatte mit offenem Unterbau - 2 Kochstellen (inbegriffen 1 Abschluss-Element mod.TPA-7) • **FR** Rechaud gaz sur armoire ouvert - 2 feux vifs (inclus 1 Élément de jonction top mod.TPA-7) • **ES SOBRES DE COCCIÓN GAS SOBRE MUEBLE ABIERTO - 2 QUEMADORES (INCLUIDA 1 CHAPA DE CIERRE PARA TOP MOD.TPA-7)**
cm. 80x 70,5x 90h



17 kW / 14.620 kcal/h
2.957,00 € / 76 / 0,71

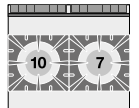

PC3-712G
08211253

PIANO COTTURA GAS SU MOBILE A GIORNO 3 fuochi (inclusa 1 testata chiusura piano mod.TPA-7)

EN Gas heated boiling unit on open cabinet - 3 burners (included 1 Head end filler strip mod.TPA-7) • **DE** Gas-Kochplatte mit offenem Unterbau - 3 Kochstellen (inbegriffen 1 Abschluss-Element mod.TPA-7) • **FR** Rechaud gaz sur armoire ouvert - 3 feux vifs (inclus 1 Élément de jonction top mod.TPA-7) • **ES SOBRES DE COCCIÓN GAS SOBRE MUEBLE ABIERTO - 3 QUEMADORES (INCLUIDA 1 CHAPA DE CIERRE PARA TOP MOD.TPA-7)**
cm. 120x 70,5x 90h

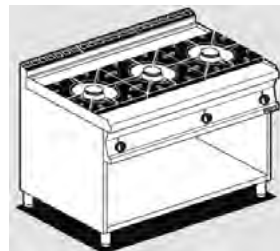

27 kW / 23.220 kcal/h
4.141,00 € / 126 / 1,05

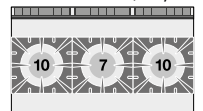

PCA-74GP
08310450

PIANO COTTURA ACQUA SU MOBILE A GIORNO 2 fuochi - Rubinetto carico acqua, sfiatore (inclusa 1 testata chiusura piano mod.TPA-7)

EN water heated boiling unit on open cabinet - 2 burners - Water loading tap + overflow device (included 1 Head end filler strip mod.TPA-7) • **DE** wasser-Kochplatte mit offenem Unterbau - 2 Kochstellen - Wasserlauf-Hahn + Überlauf-Vorrichtung (inbegriffen 1 Abschluss-Element mod.TPA-7) • **FR** Rechaud l'eau sur armoire ouvert - 2 feux vifs - Robinet d'arrivée d'eau trop plein (inclus 1 Élément de jonction top mod.TPA-7) • **ES SOBRES DE COCCIÓN AGUA SOBRE MUEBLE ABIERTO 2 QUEMADORES - GRIFO CARGA AGUA + VERTEDERO (INCLUIDA 1 CHAPA DE CIERRE PARA TOP MOD.TPA-7)**
cm. 40x 70,5x 90h

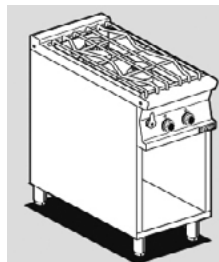

14 kW / 12.040 kcal/h
2.068,00 € / 63 / 0,37

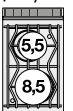

PIANI COTTURA AD ACQUA A GAS

MOD. _____ DESCRIZIONE/DESCRIPTION/BEZEICHNUNG/DESCRIPTION/DESCRIPCIÓN POTENZA/POWER/LEISTUNG/PUISSANCE/POTENCIA $\frac{kW}{kcal/h}$ $\frac{kW}{V-Hz}$ PREZZO/PRICE €
 COD. _____ DIMENSIONI/DIMENSIONS/ABMESSUNGEN/DIMENSIONS/DIMENSIONES VOLTAGGIO/VOLTAGE/SPANNUNG/VOLTAGE/VOLTAJE PREIS/PRIX/PRECIO KG / M³

PCA-78GP PIANO COTTURA ACQUA SU MOBILE A GIORNO - 4 fuochi - Rubinetto carico acqua, sfioratore (inclusa 1 testata chiusura piano mod.TPA-7)
 08310850 **EN** water heated boiling unit on open cabinet - 4 burners - Water loading tap + overflow device (included 1 Head end filler strip mod.TPA-7) • **DE** wasser-kochplatte mit offenem Unterbau - 4 Kochstellen - Wasserlauf-Hahn + Überlauf-Vorrichtung (inbegriffen 1 Abschluss-Element mod.TPA-7) • **FR** Rechaud l'eau sur armoire ouvert - 4 feux vifs - Robinet d'arrivée d'eau trop plein (inclus 1 Élément de jonction top mod.TPA-7) • **ES SOBRES DE COCCIÓN AGUA SOBRE MUEBLE ABIERTO 4 QUEMADORES - GRIFO CARGA AGUA + VERTEDERO (INCLUIDA 1 CHAPA DE CIERRE PARA TOP MOD.TPA-7) cm. 80x 70,5x 90h**



28 kW 4.067,00
 24.080 kcal/h 76 / 0,71

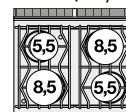

PCA-712GP PIANO COTTURA ACQUA SU MOBILE A GIORNO 6 fuochi - Rubinetto carico acqua, sfioratore (inclusa 1 testata chiusura piano mod.TPA-7)
 08311250 **EN** water heated boiling unit on open cabinet - 6 burners - Water loading tap + overflow device (included 1 Head end filler strip mod.TPA-7) • **DE** wasser-kochplatte mit offenem Unterbau - 6 Kochstellen - Wasserlauf-Hahn + Überlauf-Vorrichtung (inbegriffen 1 Abschluss-Element mod.TPA-7) • **FR** Rechaud l'eau sur armoire ouvert - 6 feux vifs - Robinet d'arrivée d'eau trop plein (inclus 1 Élément de jonction top mod.TPA-7) • **ES SOBRES DE COCCIÓN AGUA SOBRE MUEBLE ABIERTO 6 QUEMADORES - GRIFO CARGA AGUA + VERTEDERO (INCLUIDA 1 CHAPA DE CIERRE PARA TOP MOD.TPA-7) cm. 120x 70,5x 90h**

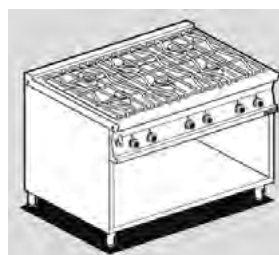

42 kW 5.844,00
 36.120 kcal/h 126 / 1,05

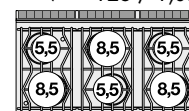

PA-78G "PAELLERO" GAS SU MOBILE A GIORNO (inclusa 1 testata chiusura piano mod.TPA-7)
 08210851 **EN** "PAELLERO" Gas - open cabinet (included 1 Head end filler strip mod.TPA-7) • **DE** "PAELLERO" Gas mit offenem Unterbau (inbegriffen 1 Abschluss-Element mod.TPA-7) • **FR** "PAELLERO" gaz sur armoire ouvert (inclus 1 Élément de jonction top mod.TPA-7) • **ES "PAELLERO" GAS SOBRE MUEBLE ABIERTO (INCLUIDA 1 CHAPA DE CIERRE PARA TOP MOD.TPA-7) cm. 80x 70,5x 90h**



11,5 kW 3.516,00
 9.890 kcal/h 111 / 0,71

PAF-78G "PAELLERO" GAS SU FORNO GAS statico cm. 67x55x34h, temp: 150÷300°C, con 1 griglia cm.65x53 GN2/1 (inclusa 1 testata chiusura piano mod.TPA-7)
 08680851 **EN** "PAELLERO" Gas on Traditional gas-oven cm. 67x55x34h, temp: 150÷300°C, with 1 grid cm.65x53 GN2/1 (included 1 Head end filler strip mod.TPA-7) • **DE** "PAELLERO" Gas mit Statischer Gas-Backofen cm. 67x55x34h, temp: 150÷300°C, mit 1 Rost cm.65x53 GN2/1 (inbegriffen 1 Abschluss-Element mod.TPA-7) • **FR** "PAELLERO" gaz sur Four à gaz statique cm. 67x55x34h, temp: 150÷300°C, avec 1 grille cm.65x53 GN2/1 (inclus 1 Élément de jonction top mod.TPA-7) • **ES "PAELLERO" GAS SOBRE HORNO A GAS ESTÁTICO CM. 67X55X34H, TEMP: 150÷300°C, CON 1 PARILLA CM.65X53 GN2/1 (INCLUIDA 1 CHAPA DE CIERRE PARA TOP MOD.TPA-7) cm. 80x 70,5x 90h**



18,8 kW 4.378,00
 16.168 kcal/h 159 / 0,71

TP-74G TUTTA PIASTRA SU MOBILE A GIORNO Piastra cm 37x57 (inclusa 1 testata chiusura piano mod.TPA-7)
 08290450 **EN** Solid top on open unit - Plate 37x57cm (included 1 Head end filler strip mod.TPA-7) • **DE** Kochplatte auf offenem Unterbau - Platte 37x57 cm (inbegriffen 1 Abschluss-Element mod.TPA-7) • **FR** Toute plaque sur meuble ouvert - Plaque cm 37x57 (inclus 1 Élément de jonction top mod.TPA-7) • **ES PLACA DE COCCIÓN SOBRE MUEBLE ABIERTO - PLACA CM 37X57 (INCLUIDA 1 CHAPA DE CIERRE PARA TOP MOD.TPA-7) cm. 40x 70,5x 90h**



7 kW 2.311,00
 6.020 kcal/h 65 / 0,37

TUTTAPIASTRA A GAS

MOD. _____
COD. _____

DESCRIZIONE/DESCRIPTION/BEZEICHNUNG/DESCRIPTION/DESCRIPCIÓN
DIMENSIONI/DIMENSIONS/ABMESSUNGEN/DIMENSIONS/DIMENSIONES

POTENZA/POWER/LEISTUNG/PUISSANCE/POTENCIA
VOLTAGGIO/VOLTAGE/SPANNUNG/VOLTAGE/VOLTAJE

⚡ kW
kcal/h

⚡ kw
V~
Hz

PREZZO/PRICE €
PREIS/PRIX/PRECIO
KG / M³

TP-78G
08290850

TUTTA PIASTRA SU MOBILE A GIORNO Piastra cm 77x57 (inclusa 1 testata chiusura piano mod.TPA-7)
EN Solid top on open unit - Plate 77x57cm (included 1 Head end filler strip mod.TPA-7) • **DE** Kochplatte auf offenem Unterbau - Platte 77x57 cm (inbegriffen 1 Abschluss-Element mod.TPA-7) • **FR** Toute plaque sur meuble ouvert - Plaque cm 77x57 (inclus 1 Élément de jonction top mod.TPA-7) • **ES PLACA DE COCCIÓN SOBRE MUEBLE ABIERTO - PLACA CM 77X57 (INCLUIDA 1 CHAPA DE CIERRE PARA TOP MOD.TPA-7)**
cm. 80x 70,5x 90h



⚡ 12 kW
10.320 kcal/h

3.144,00
121 / 0,71

TP2-78GP
08300850

TUTTA PIASTRA + 2 FUOCHI SU MOBILE A GIORNO Piastra cm. 37x57 (inclusa 1 testata chiusura piano mod.TPA-7)
EN Solid top + 2 burners on open unit Plate 37x57 (included 1 Head end filler strip mod.TPA-7) • **DE** Kochplatte + 2 Gaskochstellen auf offenem Unterbau Platte 37x57 (inbegriffen 1 Abschluss-Element mod.TPA-7) • **FR** Toute plaque + 2 brûleurs sur meuble ouvert Plaque cm. 37x57 (inclus 1 Élément de jonction top mod.TPA-7) • **ES PLACA DE COCCIÓN + 2 FUEGOS SOBRE MUEBLE ABIERTO PLACA CM. 37X57 (INCLUIDA 1 CHAPA DE CIERRE PARA TOP MOD.TPA-7)**
cm. 80x 70,5x 90h



⚡ 20 kW
17.200 kcal/h

3.623,00
115 / 0,71

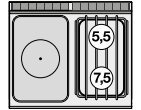

TP2-712GP
08291250

TUTTA PIASTRA + 2 FUOCHI SU MOBILE A GIORNO Piastra cm. 77x57 (inclusa 1 testata chiusura piano mod.TPA-7)
EN Solid top + 2 burners on open unit Plate 77x57 (included 1 Head end filler strip mod.TPA-7) • **DE** Kochplatte + 2 Gaskochstellen auf offenem Unterbau Platte 77x57 (inbegriffen 1 Abschluss-Element mod.TPA-7) • **FR** Toute plaque + 2 brûleurs sur meuble ouvert Plaque cm. 77x57 (inclus 1 Élément de jonction top mod.TPA-7) • **ES PLACA DE COCCIÓN + 2 FUEGOS SOBRE MUEBLE ABIERTO PLACA CM. 77X57 (INCLUIDA 1 CHAPA DE CIERRE PARA TOP MOD.TPA-7)**
cm. 120x 70,5x 90h

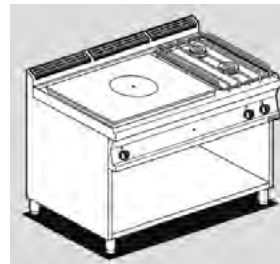

⚡ 25 kW
21.500 kcal/h

4.680,00
157 / 1,05

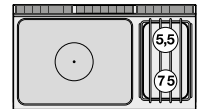

TP4-712GP
08301250

TUTTA PIASTRA + 4 FUOCHI SU MOBILE A GIORNO Piastra cm. 37x57 (inclusa 1 testata chiusura piano mod.TPA-7)
EN Solid top + 4 burners on open unit Plate 37x57 cm (included 1 Head end filler strip mod.TPA-7) • **DE** Kochplatte + 4 Gaskochstellen auf offenem Unterbau Platte 37x57 cm (inbegriffen 1 Abschluss-Element mod.TPA-7) • **FR** Toute plaque + 4 brûleurs sur meuble ouvert Plaque cm. 37x57 (inclus 1 Élément de jonction top mod.TPA-7) • **ES PLACA DE COCCIÓN + 4 FUEGOS SOBRE MUEBLE ABIERTO PLACA CM. 37X57 (INCLUIDA 1 CHAPA DE CIERRE PARA TOP MOD.TPA-7)**
cm. 120x 70,5x 90h



⚡ 29 kW
24.940 kcal/h

4.815,00
154 / 1,05

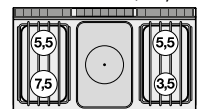

TP-78ET
08120830

TUTTA PIASTRA SU MOBILE A GIORNO Piastra cm. 70x50 - 4 zone (inclusa 1 testata chiusura piano mod.TPA-7)
EN Solid top on open unit - Plate cm. 70x50 - 4 zones (included 1 Head end filler strip mod.TPA-7) • **DE** Kochplatten auf offenem Unterbau - Platte cm. 70x50 - 4 zonen (inbegriffen 1 Abschluss-Element mod.TPA-7) • **FR** Toute plaque sur meuble ouvert - Plaque cm. 70x50 - 4 zones (inclus 1 Élément de jonction top mod.TPA-7) • **ES PLACA DE COCCIÓN SOBRE MUEBLE ABIERTO - PLACA CM. 70X50 - 4 ZONAS (INCLUIDA 1 CHAPA DE CIERRE PARA TOP MOD.TPA-7)**
cm. 80x 70,5x 90h



⚡ 10 kW
400V~3N
50/60 Hz

3.873,00
121 / 0,71

TUTTAPIASTRA ELETTRICO CON FORNO

MOD. _____
COD. _____

DESCRIZIONE/DESCRIPTION/BEZEICHNUNG/DESCRIPTION/DESCRIPCIÓN
DIMENSIONI/DIMENSIONS/ABMESSUNGEN/DIMENSIONS/DIMENSIONES

POTENZA/POWER/LEISTUNG/PUISSANCE/POTENCIA
VOLTAGGIO/VOLTAGE/SPANNUNG/VOLTAGE/VOLTAGE

⚡ kW
kcal/h

⚡ kW
V~
Hz

PREZZO/PRICE €
PREIS/PRIX/PRECIO
KG / M³

TPF-78ET
08670830

Tutta piastra su Forno elettrico statico cm. 67x55x34h, temp: 50÷300°C , con 1 griglia cm.65x53 GN2/1 - piastra cm. 70x50 4 zone (inclusa 1 testata chiusura piano mod.TPA-7)

EN Solid top on traditional electric oven cm. 67x55x34h, temp: 50÷300°C , with 1 grid cm.65x53 GN2/1 - Plate cm. 70x50 4 zones (included 1 Head end filler strip mod.TPA-7) • **DE** Kochplatten - Statischer Elektro-Backofen cm. 67x55x34h, temp: 50÷300°C , mit 1 Rost cm.65x53 GN2/1 - Platte cm. 70x50 4 zonen (inbegriffen 1 Abschluss-Element mod.TPA-7) • **FR** Toute plaque sur Four électrique statique cm. 67x55x34h, temp: 50÷300°C , avec 1 grille cm.65x53 GN2/1 - Plaque cm. 70x50 4 zones (inclus 1 Élément de jonction top mod.TPA-7) • **ES PLACA DE COCCIÓN SOBRE HORNO ELÉCTRICO ESTÁTICO CM. 67X55X34H, TEMP: 50÷300°C , CON 1 PARILLA CM.65X53 GN2/1 - PLACA CM. 70X50 4 ZONAS (INCLUIDA 1 CHAPA DE CIERRE PARA TOP MOD.TPA-7)**

cm. 80x 70,5x 90h



⚡ 15 kW
400V~3N
50/60 Hz

5.444,00
170 / 0,71

TPFV-78ET
08670835

Tutta piastra su Forno elettrico ventilato cm. 55x36x34h, temp: 50÷300°C , con 1 griglia cm.53x32,5 GN1/1 - piastra cm. 70x50 4 zone (inclusa 1 testata chiusura piano mod.TPA-7)

EN Solid top on electric fan oven cm. 55x36x34h, temp: 50÷300°C , with 1 grid cm.53x32,5 GN1/1 - Plate cm. 70x50 4 zones (included 1 Head end filler strip mod.TPA-7) • **DE** Kochplatten - Elektro-Heißluftofen cm. 55x36x34h, temp: 50÷300°C , mit 1 Rost cm.53x32,5 GN1/1 - Platte cm. 70x50 4 Zonen (inbegriffen 1 Abschluss-Element mod.TPA-7) • **FR** Toute plaque sur Four à chaleur tournante électrique cm. 55x36x34h, temp: 50÷300°C , avec 1 grille cm.53x32,5 GN1/1 - Plaque cm. 70x50 4 zones (inclus 1 Élément de jonction top mod.TPA-7) • **ES PLACA DE COCCIÓN SOBRE HORNO ELÉCTRICO VENTILADO CM. 55X36X34H, TEMP: 50÷300°C , CON 1 PARILLA CM.53X32,5 GN1/1 - PLACA CM. 70X50 4 ZONAS (INCLUIDA 1 CHAPA DE CIERRE PARA TOP MOD.TPA-7)**

cm. 80x 70,5x 90h

⚡ 15,32 kW
400V~3N
50/60 Hz

5.865,00
170 / 0,71

TPF-78G
08700850

TUTTA PIASTRA SU FORNO GAS statico cm. 67x55x34h, temp: 150÷300°C, con 1 griglia cm.65x53 GN2/1 - Piastra cm 77x57 (inclusa 1 testata chiusura piano mod.TPA-7)

EN Solid top on Traditional gas-oven cm. 67x55x34h, temp: 150÷300°C, with 1 grid cm.65x53 GN2/1 - Plate cm. 77x57 (included 1 Head end filler strip mod.TPA-7) • **DE** Kochplatten - Statischer Gas-Backofen cm. 67x55x34h, temp: 150÷300°C, mit 1 Rost cm.65x53 GN2/1 - Platte cm. 77x57 (inbegriffen 1 Abschluss-Element mod.TPA-7) • **FR** Toute plaque sur Four à gaz statique cm. 67x55x34h, temp: 150÷300°C, avec 1 grille cm.65x53 GN2/1 - Plaque cm. 77x57 (inclus 1 Élément de jonction top mod.TPA-7) • **ES PLACA DE COCCIÓN SOBRE HORNO A GAS ESTÁTICO CM. 67X55X34H, TEMP: 150÷300°C, CON 1 PARILLA CM.65X53 GN2/1 - PLACA CM. 77X57 (INCLUIDA 1 CHAPA DE CIERRE PARA TOP MOD.TPA-7)**

cm. 80x 70,5x 90h



⚡ 19,3 kW
16.600 kcal/h

4.939,00
169 / 0,71

TPF-78GE
08710860

Tutta piastra su Forno elettrico statico cm. 67x55x34h, temp: 50÷300°C , con 1 griglia cm.65x53 GN2/1 - piastra cm. 77x57 (inclusa 1 testata chiusura piano mod.TPA-7)

EN Solid top on traditional electric oven cm. 67x55x34h, temp: 50÷300°C , with 1 grid cm.65x53 GN2/1 - Plate cm. 77x57 (included 1 Head end filler strip mod.TPA-7) • **DE** Kochplatten - Statischer Elektro-Backofen cm. 67x55x34h, temp: 50÷300°C , mit 1 Rost cm.65x53 GN2/1 - Platte cm. 77x57 (inbegriffen 1 Abschluss-Element mod.TPA-7) • **FR** Toute plaque sur Four électrique statique cm. 67x55x34h, temp: 50÷300°C , avec 1 grille cm.65x53 GN2/1 - Plaque cm. 77x57 (inclus 1 Élément de jonction top mod.TPA-7) • **ES PLACA DE COCCIÓN SOBRE HORNO ELÉCTRICO ESTÁTICO CM. 67X55X34H, TEMP: 50÷300°C , CON 1 PARILLA CM.65X53 GN2/1 - PLACA CM. 77X57 (INCLUIDA 1 CHAPA DE CIERRE PARA TOP MOD.TPA-7)**

cm. 80x 70,5x 90h



⚡ 12 kW
10.320 kcal/h

4.895,00
170 / 0,71

⚡ 5 kW
400V~3N
50/60 Hz

TUTTAPIASTRA A GAS CON FORNO ELETTRICO

MOD. _____
COD. _____

DESCRIZIONE/DESCRIPTION/BEZEICHNUNG/DESCRIPTION/DESCRIPCIÓN
DIMENSIONI/DIMENSIONS/ABMESSUNGEN/DIMENSIONS/DIMENSIONES

POTENZA/POWER/LEISTUNG/PUISSANCE/POTENCIA
VOLTAGGIO/VOLTAGE/SPANNUNG/VOLTAGE/VOLTAGE

⚡ kW _____
kcal/h _____
⚡ kw _____
V- _____
Hz _____

PREZZO/PRICE €
PREIS/PRIX/PRECIO _____
KG / M³

TPFV-78GE
08710865

Tutta piastra su Forno elettrico ventilato cm. 55x36x34h, temp: 50÷300°C , con 1 griglia cm.53x32,5 GN1/1 - piastra cm. 77x57 (inclusa 1 testata chiusura piano mod.TPA-7)

EN Solid top on electric fan oven cm. 55x36x34h, temp: 50÷300°C , with 1 grid cm.53x32,5 GN1/1 - Plate cm. 77x57 (included 1 Head end filler strip mod.TPA-7) • **DE** Kochplatten - Elektro-Heißluftofen cm. 55x36x34h, temp: 50÷300°C , mit 1 Rost cm.53x32,5 GN1/1 - Platte cm. 77x57 (inbegriffen 1 Abschluss-Element mod.TPA-7) • **FR** Toute plaque sur Four à chaleur tournante électrique cm. 55x36x34h, temp: 50÷300°C , avec 1 grille cm.53x32,5 GN1/1 - Plaque cm. 77x57 (inclus 1 Élément de jonction top mod.TPA-7) • **ES PLACA DE COCCIÓN SOBRE HORNO ELÉCTRICO VENTILADO CM. 55X36X34H, TEMP: 50÷300°C , CON 1 PARILLA CM.53X32,5 GN1/1 - PLACA CM. 77X57 (INCLUIDA 1 CHAPA DE CIERRE PARA TOP MOD.TPA-7)**

cm. 80x 70,5x 90h



⚡ 12 kW _____ **5.340,00**
10.320 kcal/h _____ 170 / 0,71

⚡ 5,32 kW _____
400V~3N _____
230V~3 _____
50/60 Hz _____

TPF2-78GP
08720850

TUTTA PIASTRA + 2 FUOCHI SU FORNO GAS statico cm. 67x55x34h, temp: 150÷300°C, con 1 griglia cm.65x53 GN2/1 - Piastra cm 37x57 (inclusa 1 testata chiusura piano mod.TPA-7)

EN Solid top + 2 burners Traditional gas-oven cm. 67x55x34h, temp: 150÷300°C, with 1 grid cm.65x53 GN2/1 - Plate 37x57cm (included 1 Head end filler strip mod.TPA-7) • **DE** Kochplatte + 2 Gaskochstellen auf Statischer Gas-Backofen cm. 67x55x34h, temp: 150÷300°C, mit 1 Rost cm.65x53 GN2/1 - Platte 37x57 cm (inbegriffen 1 Abschluss-Element mod.TPA-7) • **FR** Toute plaque + 2 brûleurs sur Four à gaz statique cm. 67x55x34h, temp: 150÷300°C, avec 1 grille cm.65x53 GN2/1 - Plaque cm. 37x57 (inclus 1 Élément de jonction top mod.TPA-7) • **ES PLACA DE COCCIÓN + 2 FUEGOS SOBRE HORNO A GAS ESTÁTICO CM. 67X55X34H, TEMP: 150÷300°C, CON 1 PARILLA CM.65X53 GN2/1 - PLACA CM 37X57 (INCLUIDA 1 CHAPA DE CIERRE PARA TOP MOD.TPA-7)**

cm. 80x 70,5x 90h



⚡ 27,3 kW _____ **5.304,00**
23.478 kcal/h _____ 165 / 0,71

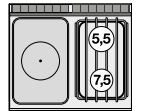

TPF2-78GPE
08730860

TUTTA PIASTRA + 2 FUOCHI SU Forno elettrico statico cm. 67x55x34h, temp: 50÷300°C , con 1 griglia cm.65x53 GN2/1 - Piastra cm 37x57 (inclusa 1 testata chiusura piano mod.TPA-7)

EN Solid top + 2 burners traditional electric oven cm. 67x55x34h, temp: 50÷300°C , with 1 grid cm.65x53 GN2/1 - Plate 37x57cm (included 1 Head end filler strip mod.TPA-7) • **DE** Kochplatte + 2 Gaskochstellen auf Statischer Elektro-Backofen cm. 67x55x34h, temp: 50÷300°C , mit 1 Rost cm.65x53 GN2/1 - Platte 37x57 cm (inbegriffen 1 Abschluss-Element mod.TPA-7) • **FR** Toute plaque + 2 brûleurs sur Four électrique statique cm. 67x55x34h, temp: 50÷300°C , avec 1 grille cm.65x53 GN2/1 - Plaque cm. 37x57 (inclus 1 Élément de jonction top mod.TPA-7) • **ES PLACA DE COCCIÓN + 2 FUEGOS SOBRE HORNO ELÉCTRICO ESTÁTICO CM. 67X55X34H, TEMP: 50÷300°C , CON 1 PARILLA CM.65X53 GN2/1 - PLACA CM 37X57 (INCLUIDA 1 CHAPA DE CIERRE PARA TOP MOD.TPA-7)**

cm. 80x 70,5x 90h



⚡ 20 kW _____ **5.257,00**
17.200 kcal/h _____ 166 / 0,71

⚡ 5 kW _____
400V~3N _____
50/60 Hz _____

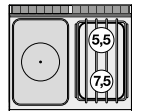

TPFV2-78GPE
08730865

TUTTA PIASTRA + 2 FUOCHI SU Forno elettrico ventilato cm. 55x36x34h, temp: 50÷300°C , con 1 griglia cm.53x32,5 GN1/1 - Piastra cm 37x57 (inclusa 1 testata chiusura piano mod.TPA-7)

EN Solid top + 2 burners electric fan oven cm. 55x36x34h, temp: 50÷300°C , with 1 grid cm.53x32,5 GN1/1 - Plate 37x57cm (included 1 Head end filler strip mod.TPA-7) • **DE** Kochplatte + 2 Gaskochstellen auf Elektro-Heißluftofen cm. 55x36x34h, temp: 50÷300°C , mit 1 Rost cm.53x32,5 GN1/1 - Platte 37x57 cm (inbegriffen 1 Abschluss-Element mod.TPA-7) • **FR** Toute plaque + 2 brûleurs sur Four à chaleur tournante électrique cm. 55x36x34h, temp: 50÷300°C , avec 1 grille cm.53x32,5 GN1/1 - Plaque cm. 37x57 (inclus 1 Élément de jonction top mod.TPA-7) • **ES PLACA DE COCCIÓN + 2 FUEGOS SOBRE HORNO ELÉCTRICO VENTILADO CM. 55X36X34H, TEMP: 50÷300°C , CON 1 PARILLA CM.53X32,5 GN1/1 - PLACA CM 37X57 (INCLUIDA 1 CHAPA DE CIERRE PARA TOP MOD.TPA-7)**

cm. 80x 70,5x 90h

⚡ 20 kW _____ **5.688,00**
17.200 kcal/h _____ 166 / 0,71

⚡ 5,32 kW _____
400V~3N _____
230V~3 _____
50/60 Hz _____

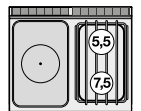

TUTTAPIASTRA A GAS CON FORNO

MOD. _____
COD. _____

DESCRIZIONE/DESCRIPTION/BEZEICHNUNG/DESCRIPTION/DESCRIPCIÓN
DIMENSIONI/DIMENSIONS/ABMESSUNGEN/DIMENSIONS/DIMENSIONES

POTENZA/POWER/LEISTUNG/PUISSANCE/POTENCIA
VOLTAGGIO/VOLTAGE/SPANNUNG/VOLTAGE/VOLTAJE

kw kcal/h
V- Hz

PREZZO/PRICE €
PREIS/PRIX/PRECIO €
KG / M³

TPF2-712GVP TUTTA PIASTRA + 2 FUOCHI SU FORNO GAS statico cm. 67x55x34h, temp: 150÷300°C, con 1 griglia cm.65x53 GN2/1 - Piastra cm 77x57 - vano neutro con porta (inclusa 1 testata chiusura piano mod.TPA-7)
EN Solid top + 2 burners Traditional gas-oven cm. 67x55x34h, temp: 150÷300°C, with 1 grid cm.65x53 GN2/1 - Plate 77x57cm - Neutral cabinet with door (included 1 Head end filler strip mod.TPA-7) • **DE** Kochplatte + 2 Gaskochstellen auf Statischer Gas-Backofen cm. 67x55x34h, temp: 150÷300°C, mit 1 Rost cm.65x53 GN2/1 - Platte 77x57 cm - Neutrales Schrankelement mit Tür (inbegriffen 1 Abschluss-Element mod.TPA-7) • **FR** Toute plaque + 2 brûleurs sur Four à gaz statique cm. 67x55x34h, temp: 150÷300°C, avec 1 grille cm.65x53 GN2/1 - Plaque cm. 77x57 - Element neutre avec porte (inclus 1 Élément de jonction top mod.TPA-7) • **ES PLACA DE COCCIÓN + 2 FUEGOS SOBRE HORNO A GAS ESTÁTICO CM. 67X55X34H, TEMP: 150÷300°C, CON 1 PARILLA CM.65X53 GN2/1 - PLACA CM 77X57 - ARMARIO NEUTRO CON PUERTA (INCLUIDA 1 CHAPA DE CIERRE PARA TOP MOD.TPA-7) cm. 120x 70,5x 90h**



32,3 kW 6.800,00
27.778 kcal/h 227 / 1,05

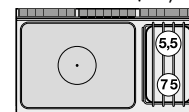

TPF2-712GPEV TUTTA PIASTRA + 2 FUOCHI SU Forno elettrico statico cm. 67x55x34h, temp: 50÷300°C, con 1 griglia cm.65x53 GN2/1 - Piastra cm 77x57 - vano neutro con porta (inclusa 1 testata chiusura piano mod.TPA-7)
EN Solid top + 2 burners traditional electric oven cm. 67x55x34h, temp: 50÷300°C, with 1 grid cm.65x53 GN2/1 - Plate 77x57cm - Neutral cabinet with door (included 1 Head end filler strip mod.TPA-7) • **DE** Kochplatte + 2 Gaskochstellen auf Statischer Elektro-Backofen cm. 67x55x34h, temp: 50÷300°C, mit 1 Rost cm.65x53 GN2/1 - Platte 77x57 cm - Neutrales Schrankelement mit Tür (inbegriffen 1 Abschluss-Element mod.TPA-7) • **FR** Toute plaque + 2 brûleurs sur Four électrique statique cm. 67x55x34h, temp: 50÷300°C, avec 1 grille cm.65x53 GN2/1 - Plaque cm. 77x57 - Element neutre avec porte (inclus 1 Élément de jonction top mod.TPA-7) • **ES PLACA DE COCCIÓN + 2 FUEGOS SOBRE HORNO ELÉCTRICO ESTÁTICO CM. 67X55X34H, TEMP: 50÷300°C, CON 1 PARILLA CM.65X53 GN2/1 - PLACA CM 77X57 - ARMARIO NEUTRO CON PUERTA (INCLUIDA 1 CHAPA DE CIERRE PARA TOP MOD.TPA-7) cm. 120x 70,5x 90h**



25 kW 6.738,00
21.500 kcal/h 227 / 1,05

5 kW
400V~3N
50/60 Hz

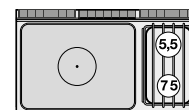

TPFV2-712GPEV TUTTA PIASTRA + 2 FUOCHI SU Forno elettrico ventilato cm. 55x36x34h, temp: 50÷300°C, con 1 griglia cm.53x32,5 GN1/1 - Piastra cm 77x57 - vano neutro con porta (inclusa 1 testata chiusura piano mod.TPA-7)
EN Solid top + 2 burners electric fan oven cm. 55x36x34h, temp: 50÷300°C, with 1 grid cm.53x32,5 GN1/1 - Plate 77x57cm - Neutral cabinet with door (included 1 Head end filler strip mod.TPA-7) • **DE** Kochplatte + 2 Gaskochstellen auf Elektro-Heißluftofen cm. 55x36x34h, temp: 50÷300°C, mit 1 Rost cm.53x32,5 GN1/1 - Platte 77x57 cm - Neutrales Schrankelement mit Tür (inbegriffen 1 Abschluss-Element mod.TPA-7) • **FR** Toute plaque + 2 brûleurs sur Four à chaleur tournante électrique cm. 55x36x34h, temp: 50÷300°C, avec 1 grille cm.53x32,5 GN1/1 Plaque cm. 77x57 - Element neutre avec porte (inclus 1 Élément de jonction top mod.TPA-7) • **ES PLACA DE COCCIÓN + 2 FUEGOS SOBRE HORNO ELÉCTRICO VENTILADO CM. 55X36X34H, TEMP: 50÷300°C, CON 1 PARILLA CM.53X32,5 GN1/1 - PLACA CM 77X57 - ARMARIO NEUTRO CON PUERTA (INCLUIDA 1 CHAPA DE CIERRE PARA TOP MOD.TPA-7) cm. 120x 70,5x 90h**

25 kW 7.182,00
21.500 kcal/h 227 / 1,05

5,32 kW
400V~3N
230V~3
50/60 Hz

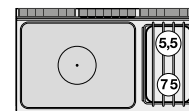

TPF2-712GP TUTTA PIASTRA + 2 FUOCHI SU FORNO GAS statico cm. 107x55x34h, temp: 150÷300°C, con 1 griglia cm.105x53 - Piastra cm 77x57 (inclusa 1 testata chiusura piano mod.TPA-7)
EN Solid top + 2 burners Traditional gas-oven cm. 107x55x34h, temp: 150÷300°C, with 1 grid cm.105x53 - Plate 77x57 (included 1 Head end filler strip mod.TPA-7) • **DE** Kochplatte + 2 Gaskochstellen auf Statischer Gas-Backofen cm. 107x55x34h, temp: 150÷300°C, mit 1 Rost cm.105x53 - Platte 77x57 (inbegriffen 1 Abschluss-Element mod.TPA-7) • **FR** Toute plaque + 2 brûleurs sur Four à gaz statique cm. 107x55x34h, temp: 150÷300°C, avec 1 grille cm.105x53 - Plaque cm. 77x57 (inclus 1 Élément de jonction top mod.TPA-7) • **ES PLACA DE COCCIÓN + 2 FUEGOS SOBRE HORNO A GAS ESTÁTICO CM. 107X55X34H, TEMP: 150÷300°C, CON 1 PARILLA CM.105X53 - PLACA CM 77X57 (INCLUIDA 1 CHAPA DE CIERRE PARA TOP MOD.TPA-7) cm. 120x 70,5x 90h**



36 kW 7.290,00
30.960 kcal/h 209 / 1,05

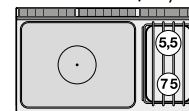

TUTTAPIASTRA A GAS CON FORNO ELETTRICO

MOD. _____
COD. _____

DESCRIZIONE/DESCRIPTION/BEZEICHNUNG/DESCRIPTION/DESCRIPCIÓN
DIMENSIONI/DIMENSIONS/ABMESSUNGEN/DIMENSIONS/DIMENSIONES

POTENZA/POWER/LEISTUNG/PUISSANCE/POTENCIA
VOLTAGGIO/VOLTAGE/SPANNUNG/VOLTAGE/VOLTAGE

⚡ kW _____
kcal/h _____
⚡ kw _____
V~ _____
Hz _____

PREZZO/PRICE €
PREIS/PRIX/PRECIO €
KG / M³

TPF2-712GPE TUTTA PIASTRA + 2 FUOCHI SU Forno elettrico statico cm. 107x55x34h,
08711260 temp: 50÷300°C, con 1 griglia cm.105x53 - Piastra cm 77x57 (inclusa
1 testata chiusura piano mod.TPA-7)
EN Solid top + 2 burners traditional electric oven cm. 107x55x34h,
temp: 50÷300°C, with 1 grid cm.105x53 - Plate 77x57 (included 1
Head end filler strip mod.TPA-7) • **DE** Kochplatte + 2 Gaskochstellen
auf Statischer Elektro-Backofen cm. 107x55x34h, temp: 50÷300°C, mit
1 Rost cm.105x53 - Platte 77x57 (inbegriffen 1 Abschluss-Element mod.
TPA-7) • **FR** Toute plaque + 2 brûleurs sur Four électrique statique cm.
107x55x34h, temp: 50÷300°C, avec 1 grille cm.105x53 - Plaque cm.
77x57 (inclus 1 Élément de jonction top mod.TPA-7) • **ES PLACA DE
COCCIÓN + 2 FUEGOS SOBRE HORNO ELÉCTRICO ESTÁTICO
CM. 107X55X34H, TEMP: 50÷300°C, CON 1 PARILLA
CM.105X53 - PLACA CM 77X57 (INCLUIDA 1 CHAPA DE
CIERRE PARA TOP MOD.TPA-7)
cm. 120x 70,5x 90h**



⚡ 25 kW **7.225,00**
21.500 kcal/h 209 / 1,05
⚡ 6,9 kW
400V~3N
50/60 Hz

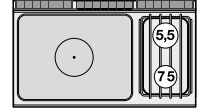

TPF4-712GPV TUTTA PIASTRA + 4 FUOCHI SU FORNO GAS statico cm. 67x55x34h,
08721251 temp: 150÷300°C, con 1 griglia cm.65x53 GN2/1 - Piastra cm 37x57 -
vano neutro con porta (inclusa 1 testata chiusura piano mod.TPA-7)
EN Solid top + 4 burners Traditional gas-oven cm. 67x55x34h, temp:
150÷300°C, with 1 grid cm.65x53 GN2/1 - Plate 37x57cm - Neutral
cabinet with door (included 1 Head end filler strip mod.TPA-7) • **DE**
Kochplatte + 4 Gaskochstellen auf Statischer Gas-Backofen cm.
67x55x34h, temp: 150÷300°C, mit 1 Rost cm.65x53 GN2/1 - Platte
37x57 cm - Neutrales Schrankelement mit Tür (inbegriffen 1 Abschluss-
Element mod.TPA-7) • **FR** Toute plaque + 4 brûleurs sur Four à gaz
statique cm. 67x55x34h, temp: 150÷300°C, avec 1 grille cm.65x53
GN2/1 - Plaque cm. 37x57 - Element neutre avec porte (inclus 1 Élément
de jonction top mod.TPA-7) • **ES PLACA DE COCCIÓN + 4 FUEGOS
SOBRE HORNO A GAS ESTÁTICO CM. 67X55X34H, TEMP:
150÷300°C, CON 1 PARILLA CM.65X53 GN2/1 - PLACA
CM 37X57 - ARMARIO NEUTRO CON PUERTA (INCLUIDA 1
CHAPA DE CIERRE PARA TOP MOD.TPA-7)
cm. 120x 70,5x 90h**



⚡ 36,3 kW **6.796,00**
31.218 kcal/h 221 / 1,05

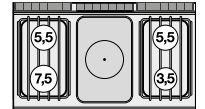

TPF4-712GPEV TUTTA PIASTRA + 4 FUOCHI SU Forno elettrico statico cm. 67x55x34h,
08731261 temp: 50÷300°C, con 1 griglia cm.65x53 GN2/1 - Piastra cm 37x57 -
vano neutro con porta (inclusa 1 testata chiusura piano mod.TPA-7)
EN Solid top + 4 burners traditional electric oven cm. 67x55x34h, temp:
50÷300°C, with 1 grid cm.65x53 GN2/1 - Plate 37x57cm - Neutral
cabinet with door (included 1 Head end filler strip mod.TPA-7) • **DE**
Kochplatte + 4 Gaskochstellen auf Statischer Elektro-Backofen cm.
67x55x34h, temp: 50÷300°C, mit 1 Rost cm.65x53 GN2/1 - Platte
37x57 cm - Neutrales Schrankelement mit Tür (inbegriffen 1 Abschluss-
Element mod.TPA-7) • **FR** Toute plaque + 4 brûleurs sur Four électrique
statique cm. 67x55x34h, temp: 50÷300°C, avec 1 grille cm.65x53
GN2/1 - Plaque cm. 37x57 - Element neutre avec porte (inclus 1 Élément
de jonction top mod.TPA-7) • **ES PLACA DE COCCIÓN + 4 FUEGOS
SOBRE HORNO ELÉCTRICO ESTÁTICO CM. 67X55X34H,
TEMP: 50÷300°C, CON 1 PARILLA CM.65X53 GN2/1
- PLACA CM 37X57 - ARMARIO NEUTRO CON PUERTA
(INCLUIDA 1 CHAPA DE CIERRE PARA TOP MOD.TPA-7)
cm. 120x 70,5x 90h**



⚡ 29 kW **6.736,00**
24.940 kcal/h 221 / 1,05

⚡ 5 kW
400V~3N
50/60 Hz

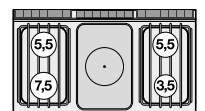

TPFV4-712GPEV TUTTA PIASTRA + 4 FUOCHI SU Forno elettrico ventilato cm. 55x36x34h,
08731266 temp: 50÷300°C, con 1 griglia cm.53x32,5 GN1/1 - Piastra cm 37x57 -
vano neutro con porta (inclusa 1 testata chiusura piano mod.TPA-7)
EN Solid top + 4 burners electric fan oven cm. 55x36x34h, temp:
50÷300°C, with 1 grid cm.53x32,5 GN1/1 - Plate 37x57cm - Neutral
cabinet with door (included 1 Head end filler strip mod.TPA-7) • **DE**
Kochplatte + 4 Gaskochstellen auf Elektro-Heißluftofen cm. 55x36x34h,
temp: 50÷300°C, mit 1 Rost cm.53x32,5 GN1/1 - Platte 37x57 cm -
Neutrales Schrankelement mit Tür (inbegriffen 1 Abschluss-Element mod.
TPA-7) • **FR** Toute plaque + 4 brûleurs sur Four à chaleur tournante
électrique cm. 55x36x34h, temp: 50÷300°C, avec 1 grille cm.53x32,5
GN1/1 - Plaque cm. 37x57 - Element neutre avec porte (inclus 1 Élément
de jonction top mod.TPA-7) • **ES PLACA DE COCCIÓN + 4 FUEGOS
SOBRE HORNO ELÉCTRICO VENTILADO CM. 55X36X34H,
TEMP: 50÷300°C, CON 1 PARILLA CM.53X32,5 GN1/1
- PLACA CM 37X57 - ARMARIO NEUTRO CON PUERTA
(INCLUIDA 1 CHAPA DE CIERRE PARA TOP MOD.TPA-7)
cm. 120x 70,5x 90h**



⚡ 29 kW **7.169,00**
24.940 kcal/h 221 / 1,05

⚡ 5,32 kW
400V~3N
230V~3
50/60 Hz

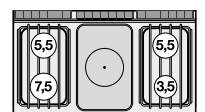

TUTTAPIASTRA A GAS CON FORNO

MOD. _____
COD. _____

DESCRIZIONE/DESCRIPTION/BEZEICHNUNG/DESCRIPTION/DESCRIPCIÓN
DIMENSIONI/DIMENSIONS/ABMESSUNGEN/DIMENSIONS/DIMENSIONES

POTENZA/POWER/LEISTUNG/PUISSANCE/POTENCIA
VOLTAGGIO/VOLTAGE/SPANNUNG/VOLTAGE/VOLTAGE

⚡ kW
kcal/h

⚡ kW
V~
Hz

PREZZO/PRICE €
PREIS/PRIX/PRECIO €
KG / M³

TPF4-712GP TUTTA PIASTRA + 4 FUOCHI SU FORNO GAS statico cm. 107x55x34h,
08721250 temp: 150÷300°C, con 1 griglia cm.105x53 - Piastra cm 37x57 (inclusa
1 testata chiusura piano mod.TPA-7)

EN Solid top + 4 burners Traditional gas-oven cm. 107x55x34h, temp: 150÷300°C, with 1 grid cm.105x53 - Plate 37x57cm (included 1 Head end filler strip mod.TPA-7) • **DE** Kochplatte + 4 Gaskochstellen auf Statischer Gas-Backofen cm. 107x55x34h, temp: 150÷300°C, mit 1 Rost cm.105x53 - Platte 37x57 cm (inbegriffen 1 Abschluss-Element mod.TPA-7) • **FR** Toute plaque + 4 brûleurs sur Four à gaz statique cm. 107x55x34h, temp: 150÷300°C, avec 1 grille cm.105x53 Plaque cm. 37x57 (inclus 1 Élément de jonction top mod.TPA-7) • **ES PLACA DE COCCIÓN + 4 FUEGOS SOBRE HORNO A GAS ESTÁTICO CM. 107X55X34H, TEMP: 150÷300°C, CON 1 PARILLA CM.105X53 - PLACA CM 37X57 (INCLUIDA 1 CHAPA DE CIERRE PARA TOP MOD.TPA-7) cm. 120x 70,5x 90h**



⚡ 40 kW
34.400 kcal/h

7.625,00
202 / 1,05

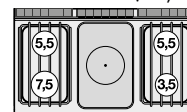

TPF4-712GPE TUTTA PIASTRA + 4 FUOCHI SU Forno elettrico statico cm. 107x55x34h,
08731260 temp: 50÷300°C, con 1 griglia cm.105x53 - Piastra cm 37x57 (inclusa
1 testata chiusura piano mod.TPA-7)

EN Solid top + 4 burners traditional electric oven cm. 107x55x34h, temp: 50÷300°C, with 1 grid cm.105x53 - Plate 37x57cm (included 1 Head end filler strip mod.TPA-7) • **DE** Kochplatte + 4 Gaskochstellen auf Statischer Elektro-Backofen cm. 107x55x34h, temp: 50÷300°C, mit 1 Rost cm.105x53 - Platte 37x57 cm (inbegriffen 1 Abschluss-Element mod.TPA-7) • **FR** Toute plaque + 4 brûleurs sur Four électrique statique cm. 107x55x34h, temp: 50÷300°C, avec 1 grille cm.105x53 - Plaque cm. 37x57 (inclus 1 Élément de jonction top mod.TPA-7) • **ES PLACA DE COCCIÓN + 4 FUEGOS SOBRE HORNO ELÉCTRICO ESTÁTICO CM. 107X55X34H, TEMP: 50÷300°C, CON 1 PARILLA CM.105X53 - PLACA CM 37X57 (INCLUIDA 1 CHAPA DE CIERRE PARA TOP MOD.TPA-7) cm. 120x 70,5x 90h**



⚡ 29 kW
24.940 kcal/h

7.557,00
202 / 1,05

⚡ 6,9 kW
400V~3N
50/60 Hz

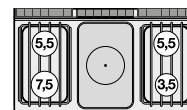

BM-74EM BAGNOMARIA MONOFASE SU MOBILE A GIORNO Vasca per GN
08050410 1/1 h.15, rubinetto carico acqua, scarico a pavimento (inclusa 1 testata
chiusura piano mod.TPA-7)

EN Bain marie singlephase on open cabinet - Bowl for GN 1/1 h.15, water loading cock, floor draining (included 1 Head end filler strip mod.TPA-7) • **DE** Wasserbäder einphasig mit offenem Unterbau - Becken GN 1/1 h.15, Wasserlauf-Hahn, Ablauf am Boden (inbegriffen 1 Abschluss-Element mod.TPA-7) • **FR** Bain marie monophasé sur armoire ouvert - Cuve GN 1/1 h.15 - Robinet d'arrivée d'eau, système de vidange au sol (inclus 1 Élément de jonction top mod.TPA-7) • **ES BAÑO DE MARÍA MONOFÁSICO SOBRE MUEBLE ABIERTO CUBA PARA GN 1/1 15H - GRIFO CARGA AGUA, DESCARGA A PAVIMENTO (INCLUIDA 1 CHAPA DE CIERRE PARA TOP MOD.TPA-7) cm. 40x 70,5x 90h**



⚡ 2,1 kW
230V~
50/60 Hz

1.872,00
41 / 0,37

BM-78ET BAGNOMARIA TRIFASE SU MOBILE A GIORNO Vasca per GN 2/1 15h,
08050830 rubinetto carico acqua, scarico a pavimento (inclusa 1 testata chiusura
piano mod.TPA-7)

EN Bain marie threephase on open cabinet - Bowl for GN 2/1 15h, water loading cock, floor draining (included 1 Head end filler strip mod.TPA-7) • **DE** Wasserbäder Dreiphasig mit offenem Unterbau - Becken GN 2/1 15h, Wasserlauf-Hahn, Ablauf am Boden (inbegriffen 1 Abschluss-Element mod.TPA-7) • **FR** Bain marie triphase sur armoire ouvert Cuve GN 2/1 15h, Robinet d'arrivée d'eau, système de vidange au sol (inclus 1 Élément de jonction top mod.TPA-7) • **ES BAÑO DE MARÍA TRIFÁSICO. SOBRE MUEBLE ABIERTO CUBA PARA GN 2/1 15H, GRIFO CARGA AGUA, DESCARGA A PAVIMENTO (INCLUIDA 1 CHAPA DE CIERRE PARA TOP MOD.TPA-7) cm. 80x 70,5x 90h**



⚡ 4,2 kW
400V~2N
230V~3
50/60 Hz

2.648,00
61 / 0,71

BAGNOMARIA A GAS

MOD. / COD.

DESCRIZIONE / DESCRIPTION / BEZEICHNUNG / DESCRIPTION / DESCRIPCIÓN
DIMENSIONI / DIMENSIONS / ABMESSUNGEN / DIMENSIONS / DIMENSIONES

POTENZA / POWER / LEISTUNG / PUISSANCE / POTENCIA
VOLTAGGIO / VOLTAGE / SPANNUNG / VOLTAGE / VOLTAJE
kW / kcal/h
V- Hz
PREZZO / PRICE / PREIS / PRIX / PRECIO € / KG / M³

BM-74G
08220450

BAGNOMARIA GAS SU MOBILE A GIORNO Vasca per GN 1/1 h.15, rubinetto carico acqua, scarico a pavimento (inclusa 1 testata chiusura piano mod.TPA-7)
EN Gas bain marie on open cabinet - Bowl for GN 1/1 h.15, water loading cock, floor draining (included 1 Head end filler strip mod.TPA-7)
• **DE** Gas Wasserbad mit offenem Unterbau - Becken GN 1/1 h.15, Wasserlauf-Hahn, Ablauf am Boden (inbegriffen 1 Abschluss-Element mod.TPA-7) • **FR** Bain-marie gaz sur armoire ouvert Cuve pour GN 1/1 h.15 - Robinet d'arrivée d'eau, système de vidange au sol (inclus 1 Elément de jonction top mod.TPA-7) • **ES BAÑO DE MARÍA GAS SOBRE MUEBLE ABIERTO - CUBA PARA GN 1/1 15H, GRIFO CARGA AGUA, DESCARGA A PAVIMENTO (INCLUIDA 1 CHAPA DE CIERRE PARA TOP MOD.TPA-7)**
cm. 40x 70,5x 90h



3,5 kW
3.010 kcal/h
1.943,00
49 / 0,37

BM-78G
08220850

BAGNOMARIA GAS SU MOBILE A GIORNO Vasca per GN 2/1 h.15, rubinetto carico acqua, scarico a pavimento. (inclusa 1 testata chiusura piano mod.TPA-7)
EN Gas ain marie on open cabinet. Bowl for GN 2/1 h.15, water loading cock, floor draining (included 1 Head end filler strip mod.TPA-7)
• **DE** Gas Wasserbad mit offenem Unterbau. Becken GN 2/1 h.15, Wasserlauf-Hahn, Ablauf am Boden. (inbegriffen 1 Abschluss-Element mod.TPA-7) • **FR** Bain-marie gaz sur armoire ouvert. Cuve pour GN 2/1 h.15, robinet d'arrivée d'eau, système de vidange au sol (inclus 1 Elément de jonction top mod.TPA-7) • **ES BAÑO DE MARÍA GAS SOBRE MUEBLE ABIERTO. CUBA PARA GN 2/1 15H, GRIFO CARGA AGUA, DESCARGA A PAVIMENTO. (INCLUIDA 1 CHAPA DE CIERRE PARA TOP MOD.TPA-7)**
cm. 80x 70,5x 90h



6,5 kW
5.590 kcal/h
3.096,00
68 / 0,71

BS-74EM
08040410

CONTENITORE CALDO CON INFRAROSSO, MONOFASE SU MOBILE A GIORNO Vasca cm. 30,5x51x16,5h con falsofondo forato (inclusa 1 testata chiusura piano mod.TPA-7)
EN Fry dump singlephase with infra-red heater on open cabinet. Bowl cm. 30,5x51x16,5h with perforated double bottom (included 1 Head end filler strip mod.TPA-7) • **DE** Frittenwanne Einphasig mit Infrarotstrahler mit offenem Unterbau. Becke cm. 30,5x51x16,5h mit gelochtem Bodenrost (inbegriffen 1 Abschluss-Element mod.TPA-7) • **FR** Silo a frites monophasé avec infrarouge sur armoire ouvert. Cuve cm 30,5x51x16,5h avec double-fond perforé. (inclus 1 Elément de jonction top mod.TPA-7) • **ES CONTENEDOR CALIENTE POR INFRARROJO, MONOFÁSICO Y SOBRE MUEBLE ABIERTO. CUBA CM. 30,5X51X16,5H CON FALSO FONDO AGUJERADO (INCLUIDA 1 CHAPA DE CIERRE PARA TOP MOD.TPA-7)**
cm. 40x 70,5x 90h



1,47 kW
230V~
50/60 Hz
2.171,00
42 / 0,40

CP-74ET
08100430

CUOCIPASTA TRIFASE LT. 25 Vasca cm. 30,5x33,5x32,7h. Rubinetto carico acqua, sfioratore + scarico a pavimento. (CESTI ESCLUSI) (inclusa 1 testata chiusura piano mod.TPA-7)
EN Pasta cooker threephase 25 lts. Tank cm. 30,5x33,5x32,7h. Water loading cock + overflow device and floor draining (BASKETS EXCLUDED) (included 1 Head end filler strip mod.TPA-7) • **DE** Nudelkocher Dreiphasig lt. 25. Becken cm. 30,5x33,5x32,7h. Wasserlauf-Hahn, + Überlauf-Vorrichtung und Ablauf am Boden (KORB AUSGESCHLOSSEN) (inbegriffen 1 Abschluss-Element mod.TPA-7) • **FR** Cuiseur à pâtes triphase lt. 25. Cuve cm.30,5x33,5x32,7h. Robinet d'arrivée d'eau trop plein + système de vidange au sol (PANIERS EXCLUS) (inclus 1 Elément de jonction top mod.TPA-7) • **ES CUECE PASTA TRIFÁSICO. 25 LT. CUBA CM. 30,5X33,5X32,7H. GRIFO CARGA AGUA + VERTEDERO + DESCARGA A PAVIMENTO (CESTAS EXCLUIDAS) (INCLUIDA 1 CHAPA DE CIERRE PARA TOP MOD.TPA-7)**
cm. 40x 70,5x 90h



7,8 kW
400V~3N
50/60 Hz
3.212,00
48 / 0,37

COMBINAZIONI

- Combinations / • Zusammenstellungen
- Combinaisons / • Combinación múltiple



CUOCIPASTA ELETTRICI

MOD. _____
COD. _____

DESCRIZIONE/DESCRIPTION/BEZEICHNUNG/DESCRIPTION/DESCRIPCIÓN
DIMENSIONI/DIMENSIONS/ABMESSUNGEN/DIMENSIONS/DIMENSIONES

POTENZA/POWER/LEISTUNG/PUISSANCE/POTENCIA
VOLTAGGIO/VOLTAGE/SPANNUNG/VOLTAGE/VOLTAGE

⚡ kW kcal/h
⚡ kw V~ Hz

PREZZO/PRICE €
PREIS/PRIX/PRECIO €
KG / M³

CPA-74ET
08100435

CUOCIPASTA TRIFASE LT. 25 Vasca cm. 30,5x33,5x32,7h. Carico acqua automatico con sensore di livello - sfioratore + scarico a pavimento (CESTI ESCLUSI) (inclusa 1 testata chiusura piano mod.TPA-7)
EN Pasta cooker threephase 25 lts. Tank cm. 30,5x33,5x32,7h. Automatic Water loading with level sensor - overflow device and floor draining (BASKETS EXCLUDED) (included 1 Head end filler strip mod.TPA-7) • **DE** Nudelkocher Dreiphasig lt. 25. Becken cm. 30,5x33,5x32,7h. Automatische Wasser Beladung mit Niveauregulierung + Überlauf-Vorrichtung und Ablauf am Boden (KORB AUSGESCHLOSSEN) (inbegriffen 1 Abschluss-Element mod.TPA-7) • **FR** Cuiseur à pates triphase lt. 25. Cuve cm.30,5x33,5x32,7h. Chargement automatique de l'eau avec sensor de niveau, trop plein système de vidange au sol (PANIERS EXCLUS) (inclus 1 Élément de jonction top mod. TPA-7) • **ES CUECE PASTA TRIFÁSICO. 25 LT. CUBA CM. 30,5X33,5X32,7H. CARGA AUTOMÁTICA DE AGUA CON SENSOR DE NIVEL + VERTEDERO + DESCARGA A PAVIMENTO. (CESTAS EXCLUIDAS) (INCLUIDA 1 CHAPA DE CIERRE PARA TOP MOD.TPA-7)**
cm. 40x 70,5x 90h



⚡ 7,8 kW **3.711,00**
400V~3N 48 / 0,37
50/60 Hz

COMBINAZIONI

- Combinations / • Zusammenstellungen
- Combinaisons / • Combinación múltiple



CP-76ET
08100630

CUOCIPASTA TRIFASE LT. 40 Vasca cm. 51x30,7x32,7h. Rubinetto carico acqua, sfioratore + scarico a pavimento. (CESTI ESCLUSI) (inclusa 1 testata chiusura piano mod.TPA-7)
EN Pasta cooker threephase 40 lts. Tank cm. 51x30,7x32,7h. Water loading cock + overflow device and floor draining (BASKETS EXCLUDED) (included 1 Head end filler strip mod.TPA-7) • **DE** Nudelkocher Dreiphasig lt. 40. Becken cm. 51x30,7x32,7h. Wasserlauf-Hahn, + Überlauf-Vorrichtung und Ablauf am Boden (KORB AUSGESCHLOSSEN) (inbegriffen 1 Abschluss-Element mod.TPA-7) • **FR** Cuiseur à pates triphase lt. 40. Cuve cm.51x30,7x32,7h. Robinet d'arrivée d'eau trop plein + système de vidange au sol (PANIERS EXCLUS) (inclus 1 Élément de jonction top mod.TPA-7) • **ES CUECE PASTA TRIFÁSICO 40 LT. CUBA CM. 51X30,7X32,7H. GRIFO CARGA AGUA + VERTEDERO + DESCARGA A PAVIMENTO (CESTAS EXCLUIDAS) (INCLUIDA 1 CHAPA DE CIERRE PARA TOP MOD.TPA-7)**
cm. 60x 70,5x 90h



⚡ 13,5 kW **4.054,00**
400V~3N 78 / 0,54
50/60 Hz

COMBINAZIONI

- Combinations / • Zusammenstellungen
- Combinaisons / • Combinación múltiple



CUOCIPASTA ELETTRICI

MOD. _____
COD. _____

DESCRIZIONE/DESCRIPTION/BEZEICHNUNG/DESCRIPTION/DESCRIPCIÓN
DIMENSIONI/DIMENSIONS/ABMESSUNGEN/DIMENSIONES/DIMENSIONES

POTENZA/POWER/LEISTUNG/PUISSANCE/POTENCIA
VOLTAGGIO/VOLTAGE/SPANNUNG/VOLTAGE/VOLTAGE

⚡ kW _____
kcal/h _____
V~ _____
Hz _____

PREZZO/PRICE €
PREIS/PRIX/PRECIO €
KG / M³

CPA-76ET
08100635

CUOCIPASTA TRIFASE LT. 40 Vasca cm. 51x30,7x32,7h. Carico acqua automatico con sensore di livello - sfioratore + scarico a pavimento (CESTI ESCLUSI) (inclusa 1 testata chiusura piano mod.TPA-7)
EN Pasta cooker threephase 40 lts. Tank cm. 51x30,7x32,7h. Automatic Water loading with level sensor - overflow device and floor draining (BASKETS EXCLUDED) (included 1 Head end filler strip mod.TPA-7) • **DE** Nudelkocher Dreiphasig lt. 40. Becken cm. 51x30,7x32,7h. Automatische Wasser Beladung mit Niveauregulierung + Überlauf-Vorrichtung und Ablauf am Boden (KORB AUSGESCHLOSSEN) (inbegriffen 1 Abschluss-Element mod.TPA-7) • **FR** Cuiseur à pates triphase lt. 40. Cuve cm.51x30,7x32,7h. Chargement automatique de l'eau avec sensor de niveau, trop plein Système de vidange au sol (PANIERS EXCLUS) (inclus 1 Élément de jonction top mod.TPA-7) • **ES CUECE PASTA TRIFÁSICO 40 LT. CUBA CM. 51X30,7X32,7H. CARGA AUTOMÁTICA DE AGUA CON SENSOR DE NIVEL + VERTEDERO + DESCARGA A PAVIMENTO. (CESTAS EXCLUIDAS) (INCLUIDA 1 CHAPA DE CIERRE PARA TOP MOD.TPA-7)**
cm. 60x 70,5x 90h



⚡ 13,5 kW _____ **4.553,00**
400V~3N _____ 78 / 0,54
50/60 Hz _____

COMBINAZIONI

- Combinations / • Zusammenstellungen
- Combinaisons / • Combinación múltiple



CP-78ET
08100830

CUOCIPASTA TRIFASE LT. 25+25 2 Vasche cm. 30,5x33,5x30h. Rubinetto carico acqua, sfioratore + scarico a pavimento (CESTI ESCLUSI) (inclusa 1 testata chiusura piano mod.TPA-7)
EN Pasta cooker threephase 25+25 lts. 2 Tanks cm. 30,5x33,5x30h. Water loading cock + overflow device and floor draining (BASKETS EXCLUDED) (included 1 Head end filler strip mod.TPA-7) • **DE** Nudelkocher dreiphasig lt. 25+25 2 Becken cm. 30,5x33,5x30h. Wasserlauf-Hahn, + Überlauf-Vorrichtung und Ablauf am Boden (KORB AUSGESCHLOSSEN) (inbegriffen 1 Abschluss-Element mod.TPA-7) • **FR** Cuiseur à pates triphase lt. 25+25 2 Cuves cm.30,5x33,5x30h. Robinet d'arrivée d'eau trop plein + système de vidange au sol En (PANIERS EXCLUS) (inclus 1 Élément de jonction top mod.TPA-7) • **ES CUECE PASTA TRIFÁSICO. 25+25 LT. 2 CUBAS CM. 30,5X33,5X30H. GRIFO CARGA AGUA + VERTEDERO + DESCARGA A PAVIMENTO (CESTAS EXCLUIDAS) (INCLUIDA 1 CHAPA DE CIERRE PARA TOP MOD.TPA-7)**
cm. 80x 70,5x 90h



⚡ 15,6 kW _____ **5.391,00**
400V~3N _____ 82 / 0,71
50/60 Hz _____

COMBINAZIONI

- Combinations / • Zusammenstellungen
- Combinaisons / • Combinación múltiple



CUOCIPASTA ELETTRICI

MOD. _____
COD. _____

DESCRIZIONE/DESCRIPTION/BEZEICHNUNG/DESCRIPTION/DESCRIPCIÓN
DIMENSIONI/DIMENSIONS/ABMESSUNGEN/DIMENSIONS/DIMENSIONES

POTENZA/POWER/LEISTUNG/PUISSANCE/POTENCIA
VOLTAGGIO/VOLTAGE/SPANUNNG/VOLTAGE/VOLTAJE

⚡ kW
kcal/h

⚡ kW
V~
Hz

PREZZO/PRICE €
PREIS/PRIX/PRECIO €
KG / M³

CPA-78ET
08100835

CUOCIPASTA TRIFASE LT. 25+25 2 Vasche cm. 30,5x33,5x30h. Carico acqua automatico con sensore di livello - sfioratore + scarico a pavimento (CESTI ESCLUSI) (inclusa 1 testata chiusura piano mod.TPA-7)
EN Pasta cooker threephase 25+25 lts. 2 Tanks cm. 30,5x33,5x30h. Automatic Water loading with level sensor - overflow device and floor draining (BASKETS EXCLUDED) (included 1 Head end filler strip mod.TPA-7) • **DE** Nudelkocher dreiphasig lt. 25+25 2 Becken cm. 30,5x33,5x30h. Automatische Wasser Beladung mit Niveauregulierung + Überlauf-Vorrichtung und Ablauf am Boden (KORB AUSGESCHLOSSEN) (inbegriffen 1 Abschluss-Element mod.TPA-7) • **FR** Cuiseur à pates triphase lt. 25+25 2 Cuves cm.30,5x33,5x30h. Chargement automatique de l'eau avec sensor de niveau, trop plein Système de vidange au sol (PANIERS EXCLUS) (inclus 1 Élément de jonction top mod.TPA-7)
• **ES CUECE PASTA TRIFÁSICO. 25+25 LT. 2 CUBAS CM. 30,5X33,5X30H. CARGA AUTOMÁTICA DE AGUA CON SENSOR DE NIVEL + VERTEDERO + DESCARGA A PAVIMENTO. (CESTAS EXCLUIDAS) (INCLUIDA 1 CHAPA DE CIERRE PARA TOP MOD.TPA-7)**
cm. 80x 70,5x 90h



⚡ 15,6 kW
400V~3N
50/60 Hz

5.890,00
82 / 0,71

COMBINAZIONI

- Combinations / • Zusammenstellungen
- Combinaisons / • Combinación múltiple



CP-74G
08270450

CUOCIPASTA GAS LT 25 Vasca cm. 30,5x33,5x32,7h. Rubinetto carico acqua, sfioratore + scarico a pavimento. (CESTI ESCLUSI) (inclusa 1 testata chiusura piano mod.TPA-7)
EN Gas pasta cooker 25 lts. Tank cm. 30,5x33,5x32,7h. Water loading cock + overflow device and floor draining (BASKETS EXCLUDED) (included 1 Head end filler strip mod.TPA-7) • **DE** Gas-Nudelkocher lt. 25. Becken cm. 30,5x33,5x32,7h. Wasserlauf-Hahn, + Überlauf-Vorrichtung und Ablauf am Boden (KORB AUSGESCHLOSSEN) (inbegriffen 1 Abschluss-Element mod.TPA-7) • **FR** Cuiseur à pates gaz lt. 25. Cuve cm.30,5x33,5x32,7h. Robinet d'arrivée d'eau trop plein + système de vidange au sol (PANIERS EXCLUS) (inclus 1 Élément de jonction top mod.TPA-7) • **ES CUECE PASTA GAS 25 LT. CUBA CM. 30,5X33,5X32,7H. GRIFO CARGA AGUA + VERTEDERO + DESCARGA A PAVIMENTO (CESTAS EXCLUIDAS) (INCLUIDA 1 CHAPA DE CIERRE PARA TOP MOD.TPA-7)**
cm. 40x 70,5x 90h



⚡ 9,5 kW
8.160 kcal/h

3.820,00
61 / 0,37

⚡ 0,02 KW
230V~
50/60 Hz

COMBINAZIONI

- Combinations / • Zusammenstellungen
- Combinaisons / • Combinación múltiple



CUOCIPASTA A GAS

MOD. _____
COD. _____

DESCRIZIONE/DESCRIPTION/BEZEICHNUNG/DESCRIPTION/DESCRIPCIÓN
DIMENSIONI/DIMENSIONS/ABMESSUNGEN/DIMENSIONS/DIMENSIONES

POTENZA/POWER/LEISTUNG/PUISSANCE/POTENCIA
VOLTAGGIO/VOLTAGE/SPANNUNG/VOLTAGE/VOLTAJE

kw kcal/h
kw V~
Hz

PREZZO/PRICE
PREIS/PRIX/PRECIO €
KG / M³

CPA-74G
08270455

CUOCIPASTA GAS LT 25 Vasca cm. 30,5x33,5x32,7h. Carico acqua automatico con sensore di livello - sfioratore + scarico a pavimento (CESTI ESCLUSI) (inclusa 1 testata chiusura piano mod.TPA-7)

EN Gas pasta cooker 25 lts. Tank cm. 30,5x33,5x32,7h. Automatic Water loading with level sensor - overflow device and floor draining (BASKETS EXCLUDED) (included 1 Head end filler strip mod.TPA-7) • **DE** Gas-Nudelkocher lt. 25. Becken cm. 30,5x33,5x32,7h. Automatische Wasser Beladung mit Niveauregulierung + Überlauf-Vorrichtung und Ablauf am Boden (KORB AUSGESCHLOSSEN) (inbegriffen 1 Abschluss-Element mod.TPA-7) • **FR** Cuiseur à pâtes gaz lt. 25. Cuve cm.30,5x33,5x32,7h. Chargement automatique de l'eau avec sensor de niveau, trop plein Système de vidange au sol (PANIERS EXCLUS) (inclus 1 Élément de jonction top mod.TPA-7) • **ES CUECE PASTA GAS 25 LT. CUBA CM. 30,5X33,5X32,7H. CARGA AUTOMÁTICA DE AGUA CON SENSOR DE NIVEL + VERTEDERO + DESCARGA A PAVIMENTO. (CESTAS EXCLUIDAS) (INCLUIDA 1 CHAPA DE CIERRE PARA TOP MOD.TPA-7)**
cm. 40x 70,5x 90h



9,5 kW 4.105,00
8.160 kcal/h 61 / 0,37

0,035 KW
230V~
50/60 Hz

COMBINAZIONI

- Combinations / • Zusammenstellungen
- Combinaisons / • Combinación múltiple



CP-76G
08270650

CUOCIPASTA GAS LT 40 Vasca cm. 51x30,7x32,7h. Rubinetto carico acqua, sfioratore + scarico a pavimento. (CESTI ESCLUSI) (inclusa 1 testata chiusura piano mod.TPA-7)

EN Gas pasta cooker 40 lts. Tank cm. 51x30,7x32,7h. Water loading cock + overflow device and floor draining (BASKETS EXCLUDED) (included 1 Head end filler strip mod.TPA-7) • **DE** Gas-Nudelkocher lt. 40. Becken cm. 51x30,7x32,7h. Wasserlauf-Hahn, + Überlauf-Vorrichtung und Ablauf am Boden (KORB AUSGESCHLOSSEN) (inbegriffen 1 Abschluss-Element mod.TPA-7) • **FR** Cuiseur à pâtes gaz lt. 40. Cuve cm.51x30,7x32,7h. Robinet d'arrivée d'eau trop plein + système de vidange au sol (PANIERS EXCLUS) (inclus 1 Élément de jonction top mod.TPA-7) • **ES CUECE PASTA GAS 40 LT. CUBA CM. 51X30,7X32,7H. GRIFO CARGA AGUA + VERTEDERO + DESCARGA A PAVIMENTO (CESTAS EXCLUIDAS) (INCLUIDA 1 CHAPA DE CIERRE PARA TOP MOD.TPA-7)**
cm. 60x 70,5x 90h



13,95 kW 4.150,00
11.997 kcal/h 80 / 0,54

0,02 KW
230V~
50/60 Hz

COMBINAZIONI

- Combinations / • Zusammenstellungen
- Combinaisons / • Combinación múltiple



CUOCIPASTA A GAS

MOD. _____
COD. _____

DESCRIZIONE/DESCRIPTION/BEZEICHNUNG/DESCRIPTION/DESCRIPCIÓN
DIMENSIONI/DIMENSIONS/ABMESSUNGEN/DIMENSIONS/DIMENSIONES

POTENZA/POWER/LEISTUNG/PUISSANCE/POTENCIA
VOLTAGGIO/VOLTAGE/SPANNUNG/VOLTAGE/VOLTAJE

⚡ kW
kcal/h

⚡ kW
V~
Hz

PREZZO/PRICE €
PREIS/PRIX/PRECIO
KG / M³

CPA-76G
08270655

CUOCIPASTA GAS LT 40 Vasca cm. 51x30,7x32,7h. Carico acqua automatico con sensore di livello - sfioratore + scarico a pavimento (CESTI ESCLUSI) (inclusa 1 testata chiusura piano mod.TPA-7)
EN Gas pasta cooker 40 lts. Tank cm. 51x30,7x32,7h. Automatic Water loading with level sensor - overflow device and floor draining (BASKETS EXCLUDED) (included 1 Head end filler strip mod.TPA-7) • **DE** Gas-Nudelkocher lt. 40. Becken cm. 51x30,7x32,7h. Automatische Wasser Beladung mit Niveauregulierung + Überlauf-Vorrichtung und Ablauf am Boden (KORB AUSGESCHLOSSEN) (inbegriffen 1 Abschluss-Element mod.TPA-7) • **FR** Cuiseur à pates gaz lt. 40. Cuve cm.51x30,7x32,7h. Chargement automatique de l'eau avec sensor de niveau, trop plein Système de vidange au sol (PANIERS EXCLUS) (inclus 1 Élément de jonction top mod.TPA-7) • **ES CUECE PASTA GAS 40 LT. CUBA CM. 51X30,7X32,7H. CARGA AUTOMÁTICA DE AGUA CON SENSOR DE NIVEL + VERTEDERO + DESCARGA A PAVIMENTO. (CESTAS EXCLUIDAS) (INCLUIDA 1 CHAPA DE CIERRE PARA TOP MOD.TPA-7)**
cm. 60x 70,5x 90h



⚡ 13,95 kW
11.997 kcal/h **4.436,00**
80 / 0,54
⚡ 0,035 KW
230V~
50/60 Hz

COMBINAZIONI

- Combinations / • Zusammenstellungen
- Combinaisons / • Combinación múltiple



CP-78G
08270850

CUOCIPASTA GAS LT. 25+25 2 Vasche cm. 30,5x33,5x32,7h. Rubinetto carico acqua, sfioratore + scarico a pavimento (CESTI ESCLUSI) (inclusa 1 testata chiusura piano mod.TPA-7)
EN Gas pasta cooker 25+25 lts. 2 Tanks cm. 30,5x33,5x32,7h. Water loading cock + overflow device and floor draining. (BASKETS EXCLUDED) (included 1 Head end filler strip mod.TPA-7) • **DE** Gas-Nudelkocher lt. 25+25 2 Becken cm. 30,5x33,5x32,7h. Wasserlauf-Hahn, + Überlauf-Vorrichtung und Ablauf am Boden (KORB AUSGESCHLOSSEN) (inbegriffen 1 Abschluss-Element mod.TPA-7) • **FR** Cuiseur à pates gaz lt. 25+25 2 Cuves cm.30,5x33,5x32,7h. robinet d'arrivée d'eau trop plein + système de vidange au sol (PANIERS EXCLUS) (inclus 1 Élément de jonction top mod.TPA-7) • **ES CUECE PASTA GAS 25+25 LT. 2 CUBAS CM. 30,5X33,5X32,7H. GRIFO CARGA AGUA + VERTEDERO + DESCARGA A PAVIMENTO (CESTAS EXCLUIDAS) (INCLUIDA 1 CHAPA DE CIERRE PARA TOP MOD.TPA-7)**
cm. 80x 70,5x 90h



⚡ 19 kW
16.320 kcal/h **5.977,00**
103 / 0,71
⚡ 0,04 KW
230V~
50/60 Hz

COMBINAZIONI

- Combinations / • Zusammenstellungen
- Combinaisons / • Combinación múltiple



CUOCIPASTA A GAS

MOD. _____
COD. _____

DESCRIZIONE/DESCRIPTION/BEZEICHNUNG/DESCRIPTION/DESCRIPCIÓN
DIMENSIONI/DIMENSIONS/ABMESSUNGEN/DIMENSIONS/DIMENSIONES

POTENZA/POWER/LEISTUNG/PUISSANCE/POTENCIA
VOLTAGGIO/VOLTAGE/SPANNUNG/VOLTAGE/VOLTAGE

⚡ kW kcal/h
⚡ kW V~ Hz

PREZZO/PRICE €
PREIS/PRIX/PRECIO €
KG / M³

CPA-78G
08270855

CUOCIPASTA GAS LT. 25+25 2 Vasche cm. 30,5x33,5x32,7h. Carico acqua automatico con sensore di livello - sfioratore + scarico a pavimento (CESTI ESCLUSI) (inclusa 1 testata chiusura piano mod.TPA-7)
EN Gas pasta cooker 25+25 lts. 2 Tanks cm. 30,5x33,5x32,7h. Automatic Water loading with level sensor - overflow device and floor draining (BASKETS EXCLUDED) (included 1 Head end filler strip mod.TPA-7) • **DE** Gas-Nudelkocher lt. 25+25 2 Becken cm. 30,5x33,5x32,7h. Automatische Wasser Beladung mit Niveauregulierung + Überlauf-Vorrichtung und Ablauf am Boden (KORB AUSGESCHLOSSEN) (inbegriffen 1 Abschluss-Element mod.TPA-7) • **FR** Cuiseur à pâtes gaz lt. 25+25 2 Cuves cm.30,5x33,5x32,7h. Chargement automatique de l'eau avec sensor de niveau, trop plein Système de vidange au sol (PANIERS EXCLUS) (inclus 1 Élément de jonction top mod.TPA-7) • **ES CUECE PASTA GAS 25+25 LT. 2 CUBAS CM. 30,5X33,5X32,7H. CARGA AUTOMÁTICA DE AGUA CON SENSOR DE NIVEL + VERTEDERO + DESCARGA A PAVIMENTO. (CESTAS EXCLUIDAS) (INCLUIDA 1 CHAPA DE CIERRE PARA TOP MOD. TPA-7)**
cm. 80x 70,5x 90h



⚡ 19 kW 6.549,00
16.320 kcal/h 103 / 0,71
⚡ 0,07 KW
230V~
50/60 Hz

COMBINAZIONI

- Combinations / • Zusammenstellungen
- Combinaisons / • Combinación múltiple



SCCP-72EM
08140210

SOLLEVATORE CESTI DA AFFIANCARE AI CUOCIPASTA CP-74/78, sollevamento automatico temporizzato o manuale, 2 aste (inclusa 1 testata chiusura piano mod.TPA-7)
EN basket elevator for pasta cooker CP-74/78, automatic timed or manual lifting, 2 rods (included 1 Head end filler strip mod.TPA-7) • **DE** heben Korbe für Nudelkocher CP-74/78, Timed oder manuelle Heben, 2 Stangen (inbegriffen 1 Abschluss-Element mod.TPA-7) • **FR** soulever des paniers pour cuiseur à pâtes CP-74/78, soulèvement temporisé ou manuel, 2 tiges (inclus 1 Élément de jonction top mod.TPA-7) • **ES LEVANTE CESTAS PARA CUECE PASTA CP-74/78, ELEVACIÓN TEMPORIZADO O MANUAL, 2 BARRAS (INCLUIDA 1 CHAPA DE CIERRE PARA TOP MOD.TPA-7)**
cm. 20x 70,5x 90h



⚡ 0,35 kW 3.498,00
230V~ 45 / 0,37
50/60 Hz

COMBINAZIONI

- Combinations / • Zusammenstellungen
- Combinaisons / • Combinación múltiple

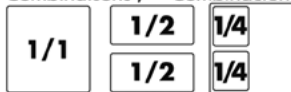

PENTOLE ELETTRICHE

MOD. _____ DESCRIZIONE/DESCRIPTION/BEZEICHNUNG/DESCRIPTION/DESCRIPCIÓN POTENZA/POWER/LEISTUNG/PUISSANCE/POTENCIA ⚡ kW ⚡ kW PREZZO/PRICE €
 COD. _____ DIMENSIONI/DIMENSIONS/ABMESSUNGEN/DIMENSIONS/DIMENSIONES VOLTAGGIO/VOLTAGE/SPANNUNG/VOLTAGE/VOLTAJE kcal/h V~ Hz PREIS/PRIX/PRECIO €
 KG / M³

PI50-78ET 08110831 **PENTOLA INDIRETTA ELETTRICA LT. 50** Vasca Ø cm. 40x45h (inclusa 1 testata chiusura piano mod.TPA-7)
EN Electric indirect boiling pan 50 lts. Tank Ø cm. 40x45h (included 1 Head end filler strip mod.TPA-7) • **DE** Indirekter Elektro-kochkessel lt. 50 Becken Ø cm. 40x45h (inbegriffen 1 Abschluss-Element mod.TPA-7) • **FR** Marmite indirecte électrique lt. 50 Cuve Ø cm. 40x45h (inclus 1 Élément de jonction top mod.TPA-7) • **ES MARMITA DE CALEFACCIÓN INDIRECTA 50 LT. CUBA Ø CM. 40X45H (INCLUIDA 1 CHAPA DE CIERRE PARA TOP MOD.TPA-7)**
cm. 80x 70,5x 90h



⚡ 9 kW **7.908,00**
 400V~3N 120 / 0,71
 50/60 Hz

PI50A-78ET 0811A831 **PENTOLA INDIRETTA ELETTRICA LT. 50** Vasca Ø cm. 40x45h - carico automatico intercapedine (inclusa 1 testata chiusura piano mod.TPA-7)
EN Electric indirect boiling pan 50 lts. Tank Ø cm. 40x45h - automatic water-charge of double jacket. (included 1 Head end filler strip mod.TPA-7) • **DE** Indirekter Elektro-kochkessel lt. 50 Becken Ø cm. 40x45h - automatische Wasserstandskontrolle im Zwischenmantel (inbegriffen 1 Abschluss-Element mod.TPA-7) • **FR** Marmite indirecte électrique lt. 50 Cuve Ø cm. 40x45h - remplissage automatique dans la double paroi (inclus 1 Élément de jonction top mod.TPA-7) • **ES MARMITA DE CALEFACCIÓN INDIRECTA 50 LT. CUBA Ø CM. 40X45H - CARGA AUTOMÁTICA DE LA CAMISA INTERCAMBIADOR (INCLUIDA 1 CHAPA DE CIERRE PARA TOP MOD.TPA-7)**
cm. 80x 70,5x 90h

⚡ 9 kW **10.308,00**
 400V~3N 120 / 0,71
 50/60 Hz

PD50-78G 08280850 **PENTOLA DIRETTA GAS LT. 50** Vasca Ø cm. 40x45h (inclusa 1 testata chiusura piano mod.TPA-7)
EN Gas direct boiling pan 50 lts - Tank Ø cm. 40x45h (included 1 Head end filler strip mod.TPA-7) • **DE** Direkter Gas-Kochkessel lt. 50 - Becken Ø cm. 40x45h (inbegriffen 1 Abschluss-Element mod.TPA-7) • **FR** Marmite directe à gaz lt. 50 - Cuve Ø cm. 40x45h (inclus 1 Élément de jonction top mod.TPA-7) • **ES MARMITA DE CALEFACCIÓN DIRECTA 50 LT. CUBA Ø CM. 40X45H (INCLUIDA 1 CHAPA DE CIERRE PARA TOP MOD.TPA-7)**
cm. 80x 70,5x 90h



⚡ 15,5 kW **6.381,00**
 13.330 kcal/h 110 / 0,71

PI50-78G 08280851 **PENTOLA INDIRETTA A GAS LT. 50** Vasca Ø cm. 40x45h (inclusa 1 testata chiusura piano mod.TPA-7)
EN Gas indirect boiling pan 50 lts. - Tank Ø cm. 40x45h (included 1 Head end filler strip mod.TPA-7) • **DE** Indirekter Gas-Kochkessel lt. 50 - Becken Ø cm. 40x45h (inbegriffen 1 Abschluss-Element mod.TPA-7) • **FR** Marmite indirecte à gaz lt. 50 - Cuve Ø cm. 40x45h (inclus 1 Élément de jonction top mod.TPA-7) • **ES MARMITA DE CALEFACCIÓN INDIRECTA A GAS LT. 50 CUBA Ø CM. 40X45H (INCLUIDA 1 CHAPA DE CIERRE PARA TOP MOD.TPA-7)**
cm. 80x 70,5x 90h

⚡ 15,5 kW **8.274,00**
 13.330 kcal/h 120 / 0,71

PI50A-78G 0828A851 **PENTOLA INDIRETTA A GAS LT. 50** Vasca Ø cm. 40x45h - carico automatico intercapedine (inclusa 1 testata chiusura piano mod.TPA-7)
EN Gas indirect boiling pan 50 lts. - Tank Ø cm. 40x45h - automatic water-charge of double jacket. (included 1 Head end filler strip mod.TPA-7) • **DE** Indirekter Gas-Kochkessel lt. 50 - Becken Ø cm. 40x45h - automatische Wasserstandskontrolle im Zwischenmantel (inbegriffen 1 Abschluss-Element mod.TPA-7) • **FR** Marmite indirecte à gaz lt. 50 - Cuve Ø cm. 40x45h - remplissage automatique dans la double paroi (inclus 1 Élément de jonction top mod.TPA-7) • **ES MARMITA DE CALEFACCIÓN INDIRECTA A GAS LT. 50 CUBA Ø CM. 40X45H - CARGA AUTOMÁTICA DE LA CAMISA INTERCAMBIADOR (INCLUIDA 1 CHAPA DE CIERRE PARA TOP MOD.TPA-7)**
cm. 80x 70,5x 90h



⚡ 15,5 kW **10.876,00**
 13.330 kcal/h 120 / 0,71

⚡ 0.1
 230V~
 50/60 Hz

531032701 **OPTIONAL: Cesto 1/1 per pentola**
EN Optional: Basket 1/1 for boiling pan • **DE** Zubehör: Korb 1/1 für Kochkessel • **FR** En option: Panier 1/1 pour marmite • **ES OPCIONAL: CESTA 1/1 POR MARMITA**
cm.Ø 36x 39,5h

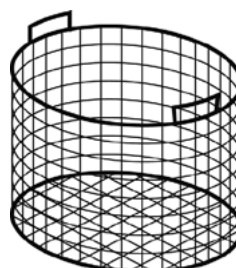

968,00
 5 / 0,08

FRY-TOP ELETTRICI

MOD. _____
COD. _____

DESCRIZIONE/DESCRIPTION/BEZEICHNUNG/DESCRIPTION/DESCRIPCIÓN
DIMENSIONI/DIMENSIONS/ABMESSUNGEN/DIMENSIONS/DIMENSIONES

POTENZA/POWER/LEISTUNG/PUISSANCE/POTENCIA
VOLTAGGIO/VOLTAGE/SPANNUNG/VOLTAGE/VOLTAJE

⚡ kW _____
kcal/h _____
V~ _____
Hz _____

PREZZO/PRICE €
PREIS/PRIX/PRECIO _____
KG / M³

FTL-74ET
08060431

Fry-top elettrico liscio, su mobile a giorno, piastra cm.36x51 (inclusa 1 testata chiusura piano mod.TPA-7)
EN Electric Fry-top smooth griddle, on open cabinet, plate cm.36x51 (included 1 Head end filler strip mod.TPA-7) • **DE** Griddleplatte elektrische glatt, mit offenem Unterbau, platte cm.36x51 (inbegriffen 1 Abschluss-Element mod.TPA-7) • **FR** Plaque électriques lisse, sur armoire ouvert, plaque cm.36x51 (inclus 1 Élément de jonction top mod.TPA-7)
• **ES FRY-TOP ELÉCTRICO LISO, SOBRE MUEBLE ABIERTO, PLANCHA CM.36X51 (INCLUIDA 1 CHAPA DE CIERRE PARA TOP MOD.TPA-7)**
cm. 40x 70,5x 90h



⚡ 5,55 kW _____ **2.311,00**
400V~3N _____ 64 / 0,37
230V~3 _____
50/60 Hz _____



FTL-74ETS
08060434

Fry-top elettrico liscio cromato SUPERCHROME (Moca Approved), su mobile a giorno, piastra cm.36x51 (inclusa 1 testata chiusura piano mod.TPA-7)
EN Electric Fry-top smooth chromed griddle SUPERCHROME (Moca Approved), on open cabinet, plate cm.36x51 (included 1 Head end filler strip mod.TPA-7) • **DE** Griddleplatte elektrische glatt hartverchromt SUPERCHROME (Moca Approved), mit offenem Unterbau, platte cm.36x51 (inbegriffen 1 Abschluss-Element mod.TPA-7) • **FR** Plaque électriques lisse chromée SUPERCHROME (Moca Approved), sur armoire ouvert, plaque cm.36x51 (inclus 1 Élément de jonction top mod.TPA-7)
• **ES FRY-TOP ELÉCTRICO LISO CROMADO SUPERCHROME (MOCA APPROVED), SOBRE MUEBLE ABIERTO, PLANCHA CM.36X51 (INCLUIDA 1 CHAPA DE CIERRE PARA TOP MOD.TPA-7)**
cm. 40x 70,5x 90h

⚡ 5,55 kW _____ **2.756,00**
400V~3N _____ 64 / 0,37
230V~3 _____
50/60 Hz _____



FTL-74ETSS
08060430

Fry-top elettrico liscio CROMO LUCIDO, su mobile a giorno, piastra cm.36x51 (inclusa 1 testata chiusura piano mod.TPA-7)
EN Electric Fry-top smooth POLISHED CHROME, on open cabinet, plate cm.36x51 (included 1 Head end filler strip mod.TPA-7) • **DE** Griddleplatte elektrische glatt POLIERTEM CHROM, mit offenem Unterbau, platte cm.36x51 (inbegriffen 1 Abschluss-Element mod.TPA-7) • **FR** Plaque électriques lisse CHROME POLI, sur armoire ouvert, plaque cm.36x51 (inclus 1 Élément de jonction top mod.TPA-7) • **ES FRY-TOP ELÉCTRICO LISO CROMO PULIDO, SOBRE MUEBLE ABIERTO, PLANCHA CM.36X51 (INCLUIDA 1 CHAPA DE CIERRE PARA TOP MOD.TPA-7)**
cm. 40x 70,5x 90h

⚡ 5,55 kW _____ **2.756,00**
400V~3N _____ 64 / 0,37
230V~3 _____
50/60 Hz _____



FTR-74ET
08060433

Fry-top elettrico rigato, su mobile a giorno, piastra cm.36x51 (inclusa 1 testata chiusura piano mod.TPA-7)
EN Electric Fry-top grooved griddle, on open cabinet, plate cm.36x51 (included 1 Head end filler strip mod.TPA-7) • **DE** Griddleplatte elektrische gerillt, mit offenem Unterbau, platte cm.36x51 (inbegriffen 1 Abschluss-Element mod.TPA-7) • **FR** Plaque électriques nervurée, sur armoire ouvert, plaque cm.36x51 (inclus 1 Élément de jonction top mod.TPA-7) • **ES FRY-TOP ELÉCTRICO ESTRIADO, SOBRE MUEBLE ABIERTO, PLANCHA CM.36X51 (INCLUIDA 1 CHAPA DE CIERRE PARA TOP MOD.TPA-7)**
cm. 40x 70,5x 90h

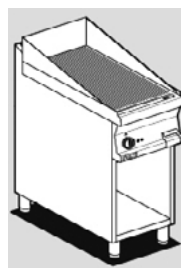

⚡ 5,55 kW _____ **2.466,00**
400V~3N _____ 64 / 0,37
230V~3 _____
50/60 Hz _____



FTR-74ETS
08060436

Fry-top elettrico rigato cromato SUPERCHROME (Moca Approved), su mobile a giorno, piastra cm.36x51 (inclusa 1 testata chiusura piano mod.TPA-7)
EN Electric Fry-top grooved chromed griddle SUPERCHROME (Moca Approved), on open cabinet, plate cm.36x51 (included 1 Head end filler strip mod.TPA-7) • **DE** Griddleplatte elektrische gerillt hartverchromt SUPERCHROME (Moca Approved), mit offenem Unterbau, platte cm.36x51 (inbegriffen 1 Abschluss-Element mod.TPA-7) • **FR** Plaque électriques nervurée chromée SUPERCHROME (Moca Approved), sur armoire ouvert, plaque cm.36x51 (inclus 1 Élément de jonction top mod.TPA-7) • **ES FRY-TOP ELÉCTRICO ESTRIADO CROMADO SUPERCHROME (MOCA APPROVED), SOBRE MUEBLE ABIERTO, PLANCHA CM.36X51 (INCLUIDA 1 CHAPA DE CIERRE PARA TOP MOD.TPA-7)**
cm. 40x 70,5x 90h

⚡ 5,55 kW _____ **2.853,00**
400V~3N _____ 64 / 0,37
230V~3 _____
50/60 Hz _____



FRY-TOP ELETTRICI

MOD. _____ DESCRIZIONE/DESCRIPTION/BEZEICHNUNG/DESCRIPTION/DESCRIPCIÓN POTENZA/POWER/LEISTUNG/PUISSANCE/POTENCIA kW kcal/h kw V~ PREZZO/PRICE €
 COD. _____ DIMENSIONI/DIMENSIONS/ABMESSUNGEN/DIMENSIONS/DIMENSIONES VOLTAGGIO/VOLTAGE/SPANNUNG/VOLTAGE/VOLTAJE 50/60 Hz PREIS/PRIX/PRECIO €
 KG / M³

FTL-76ET
08060631 Fry-top elettrico liscio, su mobile a giorno, piastra cm.56x51 (inclusa 1 testata chiusura piano mod.TPA-7)
EN Electric Fry-top smooth griddle, on open cabinet, plate cm.56x51 (included 1 Head end filler strip mod.TPA-7) • **DE** Griddleplatte elektrische glatt, mit offenem Unterbau, platte cm.56x51 (inbegriffen 1 Abschluss-Element mod.TPA-7) • **FR** Plaque électriques lisse, sur armoire ouvert, plaque cm.56x51 (inclus 1 Élément de jonction top mod.TPA-7) • **ES FRY-TOP ELÉCTRICO LISO, SOBRE MUEBLE ABIERTO, PLANCHA CM.56X51 (INCLUIDA 1 CHAPA DE CIERRE PARA TOP MOD.TPA-7)**
cm. 60x 70,5x 90h



7,4 kW **2.792,00**
 400V~3N 78 / 0,54
 50/60 Hz



FTL-76ETS
08060634 Fry-top elettrico liscio cromato SUPERCHROME (Moca Approved), su mobile a giorno, piastra cm.56x51 (inclusa 1 testata chiusura piano mod.TPA-7)
EN Electric Fry-top smooth chromed griddle SUPERCHROME (Moca Approved), on open cabinet, plate cm.56x51 (included 1 Head end filler strip mod.TPA-7) • **DE** Griddleplatte elektrische glatt hartverchromt SUPERCHROME (Moca Approved), mit offenem Unterbau, platte cm.56x51 (inbegriffen 1 Abschluss-Element mod.TPA-7) • **FR** Plaque électriques lisse chromée SUPERCHROME (Moca Approved), sur armoire ouvert, plaque cm.56x51 (inclus 1 Élément de jonction top mod.TPA-7) • **ES FRY-TOP ELÉCTRICO LISO CROMADO SUPERCHROME (MOCA APPROVED), SOBRE MUEBLE ABIERTO, PLANCHA CM.56X51 (INCLUIDA 1 CHAPA DE CIERRE PARA TOP MOD.TPA-7)**
cm. 60x 70,5x 90h

7,4 kW **3.253,00**
 400V~3N 78 / 0,54
 50/60 Hz



FTL-76ETSS
08060630 Fry-top elettrico liscio CROMO LUCIDO, su mobile a giorno, piastra cm.56x51 (inclusa 1 testata chiusura piano mod.TPA-7)
EN Electric Fry-top smooth POLISHED CHROME, on open cabinet, plate cm.56x51 (included 1 Head end filler strip mod.TPA-7) • **DE** Griddleplatte elektrische glatt POLIERTEM CHROM, mit offenem Unterbau, platte cm.56x51 (inbegriffen 1 Abschluss-Element mod.TPA-7) • **FR** Plaque électriques lisse CHROME POLI, sur armoire ouvert, plaque cm.56x51 (inclus 1 Élément de jonction top mod.TPA-7) • **ES FRY-TOP ELÉCTRICO LISO CROMO PULIDO, SOBRE MUEBLE ABIERTO, PLANCHA CM.56X51 (INCLUIDA 1 CHAPA DE CIERRE PARA TOP MOD.TPA-7)**
cm. 60x 70,5x 90h

7,4 kW **3.253,00**
 400V~3N 78 / 0,54
 50/60 Hz



FTLR-76ET
08060632 Fry-top elettrico 1/2 rigato + 1/2 liscio, su mobile a giorno, piastra cm.56x51 (inclusa 1 testata chiusura piano mod.TPA-7)
EN Electric Fry-top 1/2 grooved + 1/2 smooth, on open cabinet, plate cm.56x51 (included 1 Head end filler strip mod.TPA-7) • **DE** Griddleplatte elektrische 1/2 gerillt + 1/2 glatt, mit offenem Unterbau, platte cm.56x51 (inbegriffen 1 Abschluss-Element mod.TPA-7) • **FR** Plaque électriques 1/2 nervurée + 1/2 lisse, sur armoire ouvert, plaque cm.56x51 (inclus 1 Élément de jonction top mod.TPA-7) • **ES FRY-TOP ELÉCTRICO 1/2 ESTRIADO + 1/2 LISO, SOBRE MUEBLE ABIERTO, PLANCHA CM.56X51 (INCLUIDA 1 CHAPA DE CIERRE PARA TOP MOD.TPA-7)**
cm. 60x 70,5x 90h

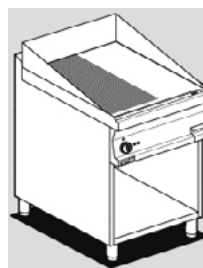

7,4 kW **2.877,00**
 400V~3N 78 / 0,54
 50/60 Hz



FTLR-76ETS
08060635 Fry-top elettrico 1/2 rigato + 1/2 liscio cromato SUPERCHROME (Moca Approved), su mobile a giorno, piastra cm.56x51 (inclusa 1 testata chiusura piano mod.TPA-7)
EN Electric Fry-top 1/2 grooved + 1/2 smooth chromed griddle SUPERCHROME (Moca Approved), on open cabinet, plate cm.56x51 (included 1 Head end filler strip mod.TPA-7) • **DE** Griddleplatte elektrische 1/2 gerillt + 1/2 glatt hartverchromt SUPERCHROME (Moca Approved), mit offenem Unterbau, platte cm.56x51 (inbegriffen 1 Abschluss-Element mod.TPA-7) • **FR** Plaque électriques 1/2 nervurée + 1/2 lisse chromée SUPERCHROME (Moca Approved), sur armoire ouvert, plaque cm.56x51 (inclus 1 Élément de jonction top mod.TPA-7) • **ES FRY-TOP ELÉCTRICO 1/2 ESTRIADO + 1/2 LISO CROMADO SUPERCHROME (MOCA APPROVED), SOBRE MUEBLE ABIERTO, PLANCHA CM.56X51 (INCLUIDA 1 CHAPA DE CIERRE PARA TOP MOD.TPA-7)**
cm. 60x 70,5x 90h

7,4 kW **3.396,00**
 400V~3N 78 / 0,54
 50/60 Hz



FRY-TOP ELETTRICI

MOD. _____
COD. _____

DESCRIZIONE/DESCRIPTION/BEZEICHNUNG/DESCRIPTION/DESCRIPCIÓN
DIMENSIONI/DIMENSIONS/ABMESSUNGEN/DIMENSIONS/DIMENSIONES

POTENZA/POWER/LEISTUNG/PUISSANCE/POTENCIA ⚡ kW _____ PREZZO/PRICE €
VOLTAGGIO/VOLTAGE/SPANNUNG/VOLTAGE/VOLTAJE kcal/h _____ PREIS/PRIX/PRECIO _____
Hz _____ KG / M³

FTR-76ET
08060633

Fry-top elettrico rigato, su mobile a giorno, piastra cm.56x51 (inclusa 1 testata chiusura piano mod.TPA-7)
EN Electric Fry-top grooved griddle, on open cabinet, plate cm.56x51 (included 1 Head end filler strip mod.TPA-7) • **DE** Griddleplatte elektrische gerillt, mit offenem Unterbau, platte cm.56x51 (inbegriffen 1 Abschluss-Element mod.TPA-7) • **FR** Plaque électriques nervurée, sur armoire ouvert, plaque cm.56x51 (inclus 1 Élément de jonction top mod.TPA-7) • **ES FRY-TOP ELÉCTRICO ESTRIADO, SOBRE MUEBLE ABIERTO, PLANCHA CM.56X51 (INCLUIDA 1 CHAPA DE CIERRE PARA TOP MOD.TPA-7)**
cm. 60x 70,5x 90h



⚡ 7,4 kW _____ **2.971,00**
400V~3N _____ 78 / 0,54
50/60 Hz

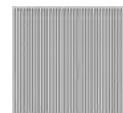

FTR-76ETS
08060636

Fry-top elettrico rigato cromato SUPERCHROME (Moca Approved), su mobile a giorno, piastra cm.56x51 (inclusa 1 testata chiusura piano mod.TPA-7)
EN Electric Fry-top grooved chromed griddle SUPERCHROME (Moca Approved), on open cabinet, plate cm.56x51 (included 1 Head end filler strip mod.TPA-7) • **DE** Griddleplatte elektrische gerillt hartverchromt SUPERCHROME (Moca Approved), mit offenem Unterbau, platte cm.56x51 (inbegriffen 1 Abschluss-Element mod.TPA-7) • **FR** Plaque électriques nervurée chromée SUPERCHROME (Moca Approved), sur armoire ouvert, plaque cm.56x51 (inclus 1 Élément de jonction top mod.TPA-7) • **ES FRY-TOP ELÉCTRICO ESTRIADO CROMADO SUPERCHROME (MOCA APPROVED), SOBRE MUEBLE ABIERTO, PLANCHA CM.56X51 (INCLUIDA 1 CHAPA DE CIERRE PARA TOP MOD.TPA-7)**
cm. 60x 70,5x 90h

⚡ 7,4 kW _____ **3.543,00**
400V~3N _____ 78 / 0,54
50/60 Hz

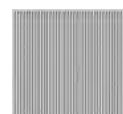

FTL-78ET
08060831

Fry-top elettrico liscio, su mobile a giorno, piastra cm.76x51 - 2 zone di cottura (inclusa 1 testata chiusura piano mod.TPA-7)
EN Electric Fry-top smooth griddle, on open cabinet, plate cm.76x51 - 2 cooking areas (included 1 Head end filler strip mod.TPA-7) • **DE** Griddleplatte elektrische glatt, mit offenem Unterbau, platte cm.76x51 - 2 Heizzonen (inbegriffen 1 Abschluss-Element mod.TPA-7) • **FR** Plaque électriques lisse, sur armoire ouvert, plaque cm.76x51 - 2 zones de cuisson (inclus 1 Élément de jonction top mod.TPA-7) • **ES FRY-TOP ELÉCTRICO LISO, SOBRE MUEBLE ABIERTO, PLANCHA CM.76X51 - 2 ZONAS DE COCCIÓN (INCLUIDA 1 CHAPA DE CIERRE PARA TOP MOD.TPA-7)**
cm. 80x 70,5x 90h



⚡ 11,1 kW _____ **3.451,00**
400V~3N _____ 110 / 0,71
230V~3 _____
50/60 Hz



FTL-78ETS
08060834

Fry-top elettrico liscio cromato SUPERCHROME (Moca Approved), su mobile a giorno, piastra cm.76x51 - 2 zone di cottura (inclusa 1 testata chiusura piano mod.TPA-7)
EN Electric Fry-top smooth chromed griddle SUPERCHROME (Moca Approved), on open cabinet, plate cm.76x51 - 2 cooking areas (included 1 Head end filler strip mod.TPA-7) • **DE** Griddleplatte elektrische glatt hartverchromt SUPERCHROME (Moca Approved), mit offenem Unterbau, platte cm.76x51 - 2 Heizzonen (inbegriffen 1 Abschluss-Element mod.TPA-7) • **FR** Plaque électriques lisse chromée SUPERCHROME (Moca Approved), sur armoire ouvert, plaque cm.76x51 - 2 zones de cuisson (inclus 1 Élément de jonction top mod.TPA-7) • **ES FRY-TOP ELÉCTRICO LISO CROMADO SUPERCHROME (MOCA APPROVED), SOBRE MUEBLE ABIERTO, PLANCHA CM.76X51 - 2 ZONAS DE COCCIÓN (INCLUIDA 1 CHAPA DE CIERRE PARA TOP MOD.TPA-7)**
cm. 80x 70,5x 90h



⚡ 11,1 kW _____ **4.106,00**
400V~3N _____ 110 / 0,71
230V~3 _____
50/60 Hz



FTL-78ETSS
08060830

Fry-top elettrico liscio CROMO LUCIDO, su mobile a giorno, piastra cm.76x51 - 2 zone di cottura (inclusa 1 testata chiusura piano mod.TPA-7)
EN Electric Fry-top smooth POLISHED CHROME, on open cabinet, plate cm.76x51 - 2 cooking areas (included 1 Head end filler strip mod.TPA-7) • **DE** Griddleplatte elektrische glatt POLIERTEM CHROM, mit offenem Unterbau, platte cm.76x51 - 2 Heizzonen (inbegriffen 1 Abschluss-Element mod.TPA-7) • **FR** Plaque électriques lisse CHROME POLI, sur armoire ouvert, plaque cm.76x51 - 2 zones de cuisson (inclus 1 Élément de jonction top mod.TPA-7) • **ES FRY-TOP ELÉCTRICO LISO CROMO PULIDO, SOBRE MUEBLE ABIERTO, PLANCHA CM.76X51 - 2 ZONAS DE COCCIÓN (INCLUIDA 1 CHAPA DE CIERRE PARA TOP MOD.TPA-7)**
cm. 80x 70,5x 90h

⚡ 11,1 kW _____ **4.106,00**
400V~3N _____ 110 / 0,71
230V~3 _____
50/60 Hz



FRY-TOP ELETTRICI

MOD. _____ DESCRIZIONE/DESCRIPTION/BEZEICHNUNG/DESCRIPTION/DESCRIPCIÓN POTENZA/POWER/LEISTUNG/PUISSANCE/POTENCIA $\frac{kW}{kcal/h}$ $\frac{kW}{V \sim}$ PREZZO/PRICE €
 COD. _____ DIMENSIONI/DIMENSIONS/ABMESSUNGEN/DIMENSIONS/DIMENSIONES VOLTAGGIO/VOLTAGE/SPANNUNG/VOLTAGE/VOLTAJE $\frac{V \sim}{Hz}$ PREIS/PRIX/PRECIO €
 KG / M³

FTLR-78ET
08060832 Fry-top elettrico 1/2 rigato + 1/2 liscio, su mobile a giorno, piastra cm.76x51 - 2 zone di cottura (inclusa 1 testata chiusura piano mod.TPA-7)
EN Electric Fry-top 1/2 grooved + 1/2 smooth, on open cabinet, plate cm.76x51 - 2 cooking areas (included 1 Head end filler strip mod.TPA-7) • **DE** Griddleplatte elektrische 1/2 gerillt + 1/2 glatt, mit offenem Unterbau, platte cm.76x51 - 2 Heizzonen (inbegriffen 1 Abschluss-Element mod.TPA-7) • **FR** Plaque électriques 1/2 nervurée + 1/2 lisse, sur armoire ouvert, plaque cm.76x51 - 2 zones de cuisson (inclus 1 Elément de jonction top mod.TPA-7) • **ES FRY-TOP ELÉCTRICO 1/2 ESTRIADO + 1/2 LISO, SOBRE MUEBLE ABIERTO, PLANCHA CM.76X51 - 2 ZONAS DE COCCIÓN (INCLUIDA 1 CHAPA DE CIERRE PARA TOP MOD.TPA-7)**
cm. 80x 70,5x 90h



⚡ 11,1 kW **3.654,00**
 400V~3N 110 / 0,71
 230V~3
 50/60 Hz



FTLR-78ETS
08060835 Fry-top elettrico 1/2 rigato + 1/2 liscio cromato SUPERCHROME (Moca Approved), su mobile a giorno, piastra cm.76x51 - 2 zone di cottura (inclusa 1 testata chiusura piano mod.TPA-7)
EN Electric Fry-top 1/2 grooved + 1/2 smooth chromed griddle SUPERCHROME (Moca Approved), on open cabinet, plate cm.76x51 - 2 cooking areas (included 1 Head end filler strip mod.TPA-7) • **DE** Griddleplatte elektrische 1/2 gerillt + 1/2 glatt hartverchromt SUPERCHROME (Moca Approved), mit offenem Unterbau, platte cm.76x51 - 2 Heizzonen (inbegriffen 1 Abschluss-Element mod.TPA-7) • **FR** Plaque électriques 1/2 nervurée + 1/2 lisse chromée SUPERCHROME (Moca Approved), sur armoire ouvert, plaque cm.76x51 - 2 zones de cuisson (inclus 1 Elément de jonction top mod.TPA-7) • **ES FRY-TOP ELÉCTRICO 1/2 ESTRIADO + 1/2 LISO CROMADO SUPERCHROME (MOCA APPROVED), SOBRE MUEBLE ABIERTO, PLANCHA CM.76X51 - 2 ZONAS DE COCCIÓN (INCLUIDA 1 CHAPA DE CIERRE PARA TOP MOD.TPA-7)**
cm. 80x 70,5x 90h

⚡ 11,1 kW **4.275,00**
 400V~3N 110 / 0,71
 230V~3
 50/60 Hz



FTR-78ET
08060833 Fry-top elettrico rigato, su mobile a giorno, piastra cm.76x51 - 2 zone di cottura (inclusa 1 testata chiusura piano mod.TPA-7)
EN Electric Fry-top grooved griddle, on open cabinet, plate cm.76x51 - 2 cooking areas (included 1 Head end filler strip mod.TPA-7) • **DE** Griddleplatte elektrische gerillt, mit offenem Unterbau, platte cm.76x51 - 2 Heizzonen (inbegriffen 1 Abschluss-Element mod.TPA-7) • **FR** Plaque électriques nervurée, sur armoire ouvert, plaque cm.76x51 - 2 zones de cuisson (inclus 1 Elément de jonction top mod.TPA-7) • **ES FRY-TOP ELÉCTRICO ESTRIADO, SOBRE MUEBLE ABIERTO, PLANCHA CM.76X51 - 2 ZONAS DE COCCIÓN (INCLUIDA 1 CHAPA DE CIERRE PARA TOP MOD.TPA-7)**
cm. 80x 70,5x 90h



⚡ 11,1 kW **3.740,00**
 400V~3N 110 / 0,71
 230V~3
 50/60 Hz



FTR-78ETS
08060836 Fry-top elettrico rigato cromato SUPERCHROME (Moca Approved), su mobile a giorno, piastra cm.76x51 - 2 zone di cottura (inclusa 1 testata chiusura piano mod.TPA-7)
EN Electric Fry-top grooved chromed griddle SUPERCHROME (Moca Approved), on open cabinet, plate cm.76x51 - 2 cooking areas (included 1 Head end filler strip mod.TPA-7) • **DE** Griddleplatte elektrische gerillt hartverchromt SUPERCHROME (Moca Approved), mit offenem Unterbau, platte cm.76x51 - 2 Heizzonen (inbegriffen 1 Abschluss-Element mod.TPA-7) • **FR** Plaque électriques nervurée chromée SUPERCHROME (Moca Approved), sur armoire ouvert, plaque cm.76x51 - 2 zones de cuisson (inclus 1 Elément de jonction top mod.TPA-7) • **ES FRY-TOP ELÉCTRICO ESTRIADO CROMADO SUPERCHROME (MOCA APPROVED), SOBRE MUEBLE ABIERTO, PLANCHA CM.76X51 - 2 ZONAS DE COCCIÓN (INCLUIDA 1 CHAPA DE CIERRE PARA TOP MOD.TPA-7)**
cm. 80x 70,5x 90h

⚡ 11,1 kW **4.456,00**
 400V~3N 110 / 0,71
 230V~3
 50/60 Hz



FRY-TOP ELETTRICI

MOD. _____
COD. _____

DESCRIZIONE/DESCRIPTION/BEZEICHNUNG/DESCRIPTION/DESCRIPCIÓN
DIMENSIONI/DIMENSIONS/ABMESSUNGEN/DIMENSIONS/DIMENSIONES

POTENZA/POWER/LEISTUNG/PUISSANCE/POTENCIA
VOLTAGGIO/VOLTAGE/SPANNUNG/VOLTAGE/VOLTAJE

⚡ kW kcal/h ⚡ kw V- Hz

PREZZO/PRICE € PREIS/PRIX/PRECIO KG / M³

FTL-712ET
08061231

Fry-top elettrico liscio, su mobile a giorno, piastra cm.116x51 - 2 zone di cottura (inclusa 1 testata chiusura piano mod.TPA-7)
EN Electric Fry-top smooth griddle, on open cabinet, plate cm.116x51 - 2 cooking areas (included 1 Head end filler strip mod.TPA-7) • **DE** Griddleplatte elektrische glatt, mit offenem Unterbau, platte cm.116x51 - 2 Heizzonen (inbegriffen 1 Abschluss-Element mod.TPA-7) • **FR** Plaque électriques lisse, sur armoire ouvert, plaque cm.116x51 - 2 zones de cuisson (inclus 1 Élément de jonction top mod.TPA-7) • **ES FRY-TOP ELÉCTRICO LISO, SOBRE MUEBLE ABIERTO, PLANCHA CM.116X51 - 2 ZONAS DE COCCIÓN (INCLUIDA 1 CHAPA DE CIERRE PARA TOP MOD.TPA-7)**
cm. 120x 70,5x 90h



⚡ 14,8 kW **4.387,00**
400V~3N 150 / 1,05
50/60 Hz



FTL-712ETS
08061234

Fry-top elettrico liscio cromato SUPERCHROME (Moca Approved), su mobile a giorno, piastra cm.116x51 - 2 zone di cottura (inclusa 1 testata chiusura piano mod.TPA-7)
EN Electric Fry-top smooth chromed griddle SUPERCHROME (Moca Approved), on open cabinet, plate cm.116x51 - 2 cooking areas (included 1 Head end filler strip mod.TPA-7) • **DE** Griddleplatte elektrische glatt hartverchromt SUPERCHROME (Moca Approved), mit offenem Unterbau, platte cm.116x51 - 2 Heizzonen (inbegriffen 1 Abschluss-Element mod.TPA-7) • **FR** Plaque électriques lisse chromée SUPERCHROME (Moca Approved), sur armoire ouvert, plaque cm.116x51 - 2 zones de cuisson (inclus 1 Élément de jonction top mod.TPA-7) • **ES FRY-TOP ELÉCTRICO LISO CROMADO SUPERCHROME (MOCA APPROVED), SOBRE MUEBLE ABIERTO, PLANCHA CM.116X51 - 2 ZONAS DE COCCIÓN (INCLUIDA 1 CHAPA DE CIERRE PARA TOP MOD.TPA-7)**
cm. 120x 70,5x 90h

⚡ 14,8 kW **5.394,00**
400V~3N 150 / 1,05
50/60 Hz



FTLR-712ET
08061232

Fry-top elettrico 1/2 rigato + 1/2 liscio, su mobile a giorno, piastra cm.116x51 - 2 zone di cottura (inclusa 1 testata chiusura piano mod.TPA-7)
EN Electric Fry-top 1/2 grooved + 1/2 smooth, on open cabinet, plate cm.116x51 - 2 cooking areas (included 1 Head end filler strip mod.TPA-7) • **DE** Griddleplatte elektrische 1/2 gerillt + 1/2 glatt, mit offenem Unterbau, platte cm.116x51 - 2 Heizzonen (inbegriffen 1 Abschluss-Element mod.TPA-7) • **FR** Plaque électriques 1/2 nervurée + 1/2 lisse, sur armoire ouvert, plaque cm.116x51 - 2 zones de cuisson (inclus 1 Élément de jonction top mod.TPA-7) • **ES FRY-TOP ELÉCTRICO 1/2 ESTRIADO + 1/2 LISO, SOBRE MUEBLE ABIERTO, PLANCHA CM.116X51 - 2 ZONAS DE COCCIÓN (INCLUIDA 1 CHAPA DE CIERRE PARA TOP MOD.TPA-7)**
cm. 120x 70,5x 90h

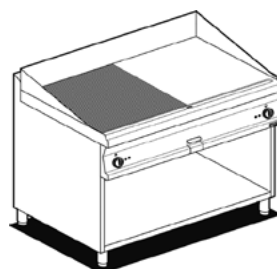

⚡ 14,8 kW **4.590,00**
400V~3N 150 / 1,05
50/60 Hz



FTLR-712ETS
08061235

Fry-top elettrico 1/2 rigato + 1/2 liscio cromato SUPERCHROME (Moca Approved), su mobile a giorno, piastra cm.116x51 - 2 zone di cottura (inclusa 1 testata chiusura piano mod.TPA-7)
EN Electric Fry-top 1/2 grooved + 1/2 smooth chromed griddle SUPERCHROME (Moca Approved), on open cabinet, plate cm.116x51 - 2 cooking areas (included 1 Head end filler strip mod.TPA-7) • **DE** Griddleplatte elektrische 1/2 gerillt + 1/2 glatt hartverchromt SUPERCHROME (Moca Approved), mit offenem Unterbau, platte cm.116x51 - 2 Heizzonen (inbegriffen 1 Abschluss-Element mod.TPA-7) • **FR** Plaque électriques 1/2 nervurée + 1/2 lisse chromée SUPERCHROME (Moca Approved), sur armoire ouvert, plaque cm.116x51 - 2 zones de cuisson (inclus 1 Élément de jonction top mod.TPA-7) • **ES FRY-TOP ELÉCTRICO 1/2 ESTRIADO + 1/2 LISO CROMADO SUPERCHROME (MOCA APPROVED), SOBRE MUEBLE ABIERTO, PLANCHA CM.116X51 - 2 ZONAS DE COCCIÓN (INCLUIDA 1 CHAPA DE CIERRE PARA TOP MOD.TPA-7)**
cm. 120x 70,5x 90h

⚡ 14,8 kW **5.701,00**
400V~3N 150 / 1,05
50/60 Hz



FRY-TOP ELETTRICI

MOD. _____ DESCRIZIONE/DESCRIPTION/BEZEICHNUNG/DESCRIPTION/DESCRIPCIÓN POTENZA/POWER/LEISTUNG/PUISSANCE/POTENCIA ⚡ kW ⚡ kw PREZZO/PRICE €
 COD. _____ DIMENSIONI/DIMENSIONS/ABMESSUNGEN/DIMENSIONS/DIMENSIONES VOLTAGGIO/VOLTAGE/SPANNUNG/VOLTAGE/VOLTAJE kcal/h V~ Hz PREIS/PRIX/PRECIO KG / M³

FTR-712ET Fry-top elettrico rigato, su mobile a giorno, piastra cm.116x51 - 2 zone di cottura (inclusa 1 testata chiusura piano mod.TPA-7)
EN Electric Fry-top grooved griddle, on open cabinet, plate cm.116x51 - 2 cooking areas (included 1 Head end filler strip mod.TPA-7) • **DE** Griddleplatte elektrische gerillt, mit offenem Unterbau, platte cm.116x51 - 2 Heizzonen (inbegriffen 1 Abschluss-Element mod.TPA-7) • **FR** Plaque électriques nervurée, sur armoire ouvert, plaque cm.116x51 - 2 zones de cuisson (inclus 1 Élément de jonction top mod.TPA-7) • **ES FRY-TOP ELÉCTRICO ESTRIADO, SOBRE MUEBLE ABIERTO, PLANCHA CM.116X51 - 2 ZONAS DE COCCIÓN (INCLUIDA 1 CHAPA DE CIERRE PARA TOP MOD.TPA-7)**
cm. 120x 70,5x 90h

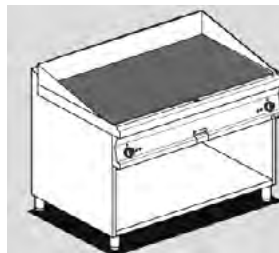

⚡ 14,8 kW **4.804,00**
 400V~3N 150 / 1,05
 50/60 Hz



FTR-712ETS Fry-top elettrico rigato cromato SUPERCHROME (Moca Approved), su mobile a giorno, piastra cm.116x51 - 2 zone di cottura (inclusa 1 testata chiusura piano mod.TPA-7)
EN Electric Fry-top grooved chromed griddle SUPERCHROME (Moca Approved), on open cabinet, plate cm.116x51 - 2 cooking areas (included 1 Head end filler strip mod.TPA-7) • **DE** Griddleplatte elektrische gerillt hartverchromt SUPERCHROME (Moca Approved), mit offenem Unterbau, platte cm.116x51 - 2 Heizzonen (inbegriffen 1 Abschluss-Element mod.TPA-7) • **FR** Plaque électriques nervurée chromée SUPERCHROME (Moca Approved), sur armoire ouvert, plaque cm.116x51 - 2 zones de cuisson (inclus 1 Élément de jonction top mod.TPA-7) • **ES FRY-TOP ELÉCTRICO ESTRIADO CROMADO SUPERCHROME (Moca APPROVED), SOBRE MUEBLE ABIERTO, PLANCHA CM.116X51 - 2 ZONAS DE COCCIÓN (INCLUIDA 1 CHAPA DE CIERRE PARA TOP MOD.TPA-7)**
cm. 120x 70,5x 90h

⚡ 14,8 kW **6.099,00**
 400V~3N 150 / 1,05
 50/60 Hz



FTL-712ET3 Fry-top elettrico liscio, su mobile a giorno, piastra cm.116x51 - 3 zone di cottura (inclusa 1 testata chiusura piano mod.TPA-7)
EN Electric Fry-top smooth griddle, on open cabinet, plate cm.116x51 - 3 cooking areas (included 1 Head end filler strip mod.TPA-7) • **DE** Griddleplatte elektrische glatt, mit offenem Unterbau, platte cm.116x51 - 3 Heizzonen (inbegriffen 1 Abschluss-Element mod.TPA-7) • **FR** Plaque électriques lisse, sur armoire ouvert, plaque cm.116x51 - 3 zones de cuisson (inclus 1 Élément de jonction top mod.TPA-7) • **ES FRY-TOP ELÉCTRICO LISO, SOBRE MUEBLE ABIERTO, PLANCHA CM.116X51 - 3 ZONAS DE COCCIÓN (INCLUIDA 1 CHAPA DE CIERRE PARA TOP MOD.TPA-7)**
cm. 120x 70,5x 90h



⚡ 16,65 kW **4.804,00**
 400V~3N 150 / 1,05
 50/60 Hz



FTL-712ETS3 Fry-top elettrico liscio cromato SUPERCHROME (Moca Approved), su mobile a giorno, piastra cm.116x51 - 3 zone di cottura (inclusa 1 testata chiusura piano mod.TPA-7)
EN Electric Fry-top smooth chromed griddle SUPERCHROME (Moca Approved), on open cabinet, plate cm.116x51 - 3 cooking areas (included 1 Head end filler strip mod.TPA-7) • **DE** Griddleplatte elektrische glatt hartverchromt SUPERCHROME (Moca Approved), mit offenem Unterbau, platte cm.116x51 - 3 Heizzonen (inbegriffen 1 Abschluss-Element mod.TPA-7) • **FR** Plaque électriques lisse chromée SUPERCHROME (Moca Approved), sur armoire ouvert, plaque cm.116x51 - 3 zones de cuisson (inclus 1 Élément de jonction top mod.TPA-7) • **ES FRY-TOP ELÉCTRICO LISO CROMADO SUPERCHROME (Moca APPROVED), SOBRE MUEBLE ABIERTO, PLANCHA CM.116X51 - 3 ZONAS DE COCCIÓN (INCLUIDA 1 CHAPA DE CIERRE PARA TOP MOD.TPA-7)**
cm. 120x 70,5x 90h

⚡ 16,65 kW **5.763,00**
 400V~3N 150 / 1,05
 50/60 Hz



FRY-TOP ELETTRICI

MOD. _____
COD. _____

DESCRIZIONE/DESCRIPTION/BEZEICHNUNG/DESCRIPTION/DESCRIPCIÓN
DIMENSIONI/DIMENSIONS/ABMESSUNGEN/DIMENSIONS/DIMENSIONES

POTENZA/POWER/LEISTUNG/PUISSANCE/POTENCIA
VOLTAGGIO/VOLTAGE/SPANNUNG/VOLTAGE/VOLTAJE

⚡ kW _____
kcal/h _____
V~ _____
Hz _____

PREZZO/PRICE €
PREIS/PRIX/PRECIO _____
KG / M³

FTL-712ETSS3 Fry-top elettrico liscio CROMO LUCIDO, su mobile a giorno, piastra cm.116x51 - 3 zone di cottura (inclusa 1 testata chiusura piano mod. TPA-7)
0806123Y

EN Electric Fry-top smooth POLISHED CHROME, on open cabinet, plate cm.116x51 - 3 cooking areas (included 1 Head end filler strip mod.TPA-7) • **DE** Griddleplatte elektrische glatt POLIERTEM CHROM, mit offenem Unterbau, platte cm.116x51 - 3 Heizzonen (inbegriffen 1 Abschluss-Element mod.TPA-7) • **FR** Plaque électriques lisse CHROME POLI, sur armoire ouvert, plaque cm.116x51 - 3 zones de cuisson (inclus 1 Élément de jonction top mod.TPA-7) • **ES FRY-TOP ELÉCTRICO LISO CROMO PULIDO, SOBRE MUEBLE ABIERTO, PLANCHA CM.116X51 - 3 ZONAS DE COCCIÓN (INCLUIDA 1 CHAPA DE CIERRE PARA TOP MOD.TPA-7)**
cm. 120x 70,5x 90h



⚡ 16,65 kW **5.763,00**
400V~3N 150 / 1,05
50/60 Hz

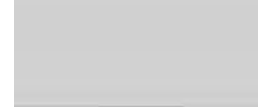

FTLR-712ET3 Fry-top elettrico 1/3 rigato + 2/3 liscio, su mobile a giorno, piastra cm.116x51 - 3 zone di cottura (inclusa 1 testata chiusura piano mod. TPA-7)
0806123C

EN Electric Fry-top 1/3 grooved + 2/3 smooth, on open cabinet, plate cm.116x51 - 3 cooking areas (included 1 Head end filler strip mod. TPA-7) • **DE** Griddleplatte elektrische 1/3 gerillt + 2/3 glatt, mit offenem Unterbau, platte cm.116x51 - 3 Heizzonen (inbegriffen 1 Abschluss-Element mod.TPA-7) • **FR** Plaque électriques 1/3 nervurée + 2/3 lisse, sur armoire ouvert, plaque cm.116x51 - 3 zones de cuisson (inclus 1 Élément de jonction top mod.TPA-7) • **ES FRY-TOP ELÉCTRICO 1/3 ESTRIADO + 2/3 LISO, SOBRE MUEBLE ABIERTO, PLANCHA CM.116X51 - 3 ZONAS DE COCCIÓN (INCLUIDA 1 CHAPA DE CIERRE PARA TOP MOD.TPA-7)**
cm. 120x 70,5x 90h



⚡ 16,65 KW **4.932,00**
400V~3N 150 / 1,05
50/60 Hz



FTLR-712ETS3 Fry-top elettrico 1/3 rigato + 2/3 liscio cromato SUPERCHROME (Moca Approved), su mobile a giorno, piastra cm.116x51 - 3 zone di cottura (inclusa 1 testata chiusura piano mod.TPA-7)
0806123F

EN Electric Fry-top 1/3 grooved + 2/3 smooth chromed griddle SUPERCHROME (Moca Approved), on open cabinet, plate cm.116x51 - 3 cooking areas (included 1 Head end filler strip mod.TPA-7) • **DE** Griddleplatte elektrische 1/3 gerillt + 2/3 glatt hartverchromt SUPERCHROME (Moca Approved), mit offenem Unterbau, platte cm.116x51 - 3 Heizzonen (inbegriffen 1 Abschluss-Element mod. TPA-7) • **FR** Plaque électriques 1/3 nervurée + 2/3 lisse chromée SUPERCHROME (Moca Approved), sur armoire ouvert, plaque cm.116x51 - 3 zones de cuisson (inclus 1 Élément de jonction top mod.TPA-7) • **ES FRY-TOP ELÉCTRICO 1/3 ESTRIADO + 2/3 LISO CROMADO SUPERCHROME (MOCA APPROVED), SOBRE MUEBLE ABIERTO, PLANCHA CM.116X51 - 3 ZONAS DE COCCIÓN (INCLUIDA 1 CHAPA DE CIERRE PARA TOP MOD.TPA-7)**
cm. 120x 70,5x 90h

⚡ 16,65 kW **5.900,00**
400V~3N 150 / 1,05
50/60 Hz



FTL-74G Fry-top gas liscio, su mobile a giorno, piastra cm.36x51 (inclusa 1 testata chiusura piano mod.TPA-7)
08230451

EN Gas Fry-top smooth griddle, on open cabinet, plate cm.36x51 (included 1 Head end filler strip mod.TPA-7) • **DE** Gas-griddleplatte glatt, mit offenem Unterbau, platte cm.36x51 (inbegriffen 1 Abschluss-Element mod.TPA-7) • **FR** Plaque gaz lisse, sur armoire ouvert, plaque cm.36x51 (inclus 1 Élément de jonction top mod.TPA-7) • **ES FRY-TOP GAS LISO, SOBRE MUEBLE ABIERTO, PLANCHA CM.36X51 (INCLUIDA 1 CHAPA DE CIERRE PARA TOP MOD.TPA-7)**
cm. 40x 70,5x 90h



⚡ 7 kW **2.422,00**
6.020 kcal/h 69 / 0,37



FTL-74GS Fry-top gas liscio cromato SUPERCHROME (Moca Approved), su mobile a giorno, piastra cm.36x51 (inclusa 1 testata chiusura piano mod.TPA-7)
08230454

EN Gas Fry-top smooth chromed griddle SUPERCHROME (Moca Approved), on open cabinet, plate cm.36x51 (included 1 Head end filler strip mod.TPA-7) • **DE** Gas-griddleplatte glatt hartverchromt SUPERCHROME (Moca Approved), mit offenem Unterbau, platte cm.36x51 (inbegriffen 1 Abschluss-Element mod.TPA-7) • **FR** Plaque gaz lisse chromée SUPERCHROME (Moca Approved), sur armoire ouvert, plaque cm.36x51 (inclus 1 Élément de jonction top mod.TPA-7) • **ES FRY-TOP GAS LISO CROMADO SUPERCHROME (MOCA APPROVED), SOBRE MUEBLE ABIERTO, PLANCHA CM.36X51 (INCLUIDA 1 CHAPA DE CIERRE PARA TOP MOD.TPA-7)**
cm. 40x 70,5x 90h

⚡ 7 kW **2.868,00**
6.020 kcal/h 69 / 0,37



FRY-TOP A GAS

MOD. COD.	DESCRIZIONE/DESCRIPTION/BEZEICHNUNG/DESCRIPTION/DESCRIPCIÓN DIMENSIONI/DIMENSIONS/ABMESSUNGEN/DIMENSIONS/DIMENSIONES	POTENZA/POWER/LEISTUNG/PUISSANCE/POTENCIA VOLTAGGIO/VOLTAGE/SPANNUNG/VOLTAGE/VOLTAJE	$\frac{\text{kW}}{\text{kcal/h}}$ $\frac{\text{V}}{\text{Hz}}$	PREZZO/PRICE € KG / M ³
---------------------	---	---	---	--

FTL-74GSS
08230450

Fry-top gas liscio CROMO LUCIDO, su mobile a giorno, piastra cm.36x51 (inclusa 1 testata chiusura piano mod.TPA-7)

EN Gas Fry-top smooth POLISHED CHROME, on open cabinet, plate cm.36x51 (included 1 Head end filler strip mod.TPA-7) • **DE** Gas-griddleplatte glatt POLIERTEM CHROM, mit offenem Unterbau, platte cm.36x51 (inbegriffen 1 Abschluss-Element mod.TPA-7) • **FR** Plaque gaz lisse CHROME POLI, sur armoire ouvert, plaque cm.36x51 (inclus 1 Élément de jonction top mod.TPA-7) • **ES FRY-TOP GAS LISO CROMO PULIDO, SOBRE MUEBLE ABIERTO, PLANCHA CM.36X51 (INCLUIDA 1 CHAPA DE CIERRE PARA TOP MOD. TPA-7)**

cm. 40x 70,5x 90h



$\frac{7 \text{ kW}}{6.020 \text{ kcal/h}}$ **2.868,00**
69 / 0,37

FTR-74G
08230453

Fry-top gas rigato, su mobile a giorno, piastra cm.36x51 (inclusa 1 testata chiusura piano mod.TPA-7)

EN Gas Fry-top grooved griddle, on open cabinet, plate cm.36x51 (included 1 Head end filler strip mod.TPA-7) • **DE** Gas-griddleplatte gerillt, mit offenem Unterbau, platte cm.36x51 (inbegriffen 1 Abschluss-Element mod.TPA-7) • **FR** Plaque gaz nervurée, sur armoire ouvert, plaque cm.36x51 (inclus 1 Élément de jonction top mod.TPA-7) • **ES FRY-TOP GAS ESTRIADO, SOBRE MUEBLE ABIERTO, PLANCHA CM.36X51 (INCLUIDA 1 CHAPA DE CIERRE PARA TOP MOD. TPA-7)**

cm. 40x 70,5x 90h

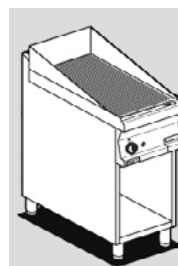

$\frac{7 \text{ kW}}{6.020 \text{ kcal/h}}$ **2.596,00**
69 / 0,37

FTR-74GS
08230456

Fry-top gas rigato cromato SUPERCHROME (Moca Approved), su mobile a giorno, piastra cm.36x51 (inclusa 1 testata chiusura piano mod.TPA-7)

EN Gas Fry-top grooved chromed griddle SUPERCHROME (Moca Approved), on open cabinet, plate cm.36x51 (included 1 Head end filler strip mod.TPA-7) • **DE** Gas-griddleplatte gerillt hartverchromt SUPERCHROME (Moca Approved), mit offenem Unterbau, platte cm.36x51 (inbegriffen 1 Abschluss-Element mod.TPA-7) • **FR** Plaque gaz nervurée chromée SUPERCHROME (Moca Approved), sur armoire ouvert, plaque cm.36x51 (inclus 1 Élément de jonction top mod.TPA-7) • **ES FRY-TOP GAS ESTRIADO CROMADO SUPERCHROME (MOCA APPROVED), SOBRE MUEBLE ABIERTO, PLANCHA CM.36X51 (INCLUIDA 1 CHAPA DE CIERRE PARA TOP MOD.TPA-7)**

cm. 40x 70,5x 90h

$\frac{7 \text{ kW}}{6.020 \text{ kcal/h}}$ **3.036,00**
69 / 0,37

FTL-76G
08230651

Fry-top gas liscio, su mobile a giorno, piastra cm.56x51 (inclusa 1 testata chiusura piano mod.TPA-7)

EN Gas Fry-top smooth griddle, on open cabinet, plate cm.56x51 (included 1 Head end filler strip mod.TPA-7) • **DE** Gas-griddleplatte glatt, mit offenem Unterbau, platte cm.56x51 (inbegriffen 1 Abschluss-Element mod.TPA-7) • **FR** Plaque gaz lisse, sur armoire ouvert, plaque cm.56x51 (inclus 1 Élément de jonction top mod.TPA-7) • **ES FRY-TOP GAS LISO, SOBRE MUEBLE ABIERTO, PLANCHA CM.56X51 (INCLUIDA 1 CHAPA DE CIERRE PARA TOP MOD.TPA-7)**

cm. 60x 70,5x 90h



$\frac{10,5 \text{ kW}}{9.030 \text{ kcal/h}}$ **2.835,00**
83 / 0,54

FTL-76GS
08230654

Fry-top gas liscio cromato SUPERCHROME (Moca Approved), su mobile a giorno, piastra cm.56x51 (inclusa 1 testata chiusura piano mod.TPA-7)

EN Gas Fry-top smooth chromed griddle SUPERCHROME (Moca Approved), on open cabinet, plate cm.56x51 (included 1 Head end filler strip mod.TPA-7) • **DE** Gas-griddleplatte glatt hartverchromt SUPERCHROME (Moca Approved), mit offenem Unterbau, platte cm.56x51 (inbegriffen 1 Abschluss-Element mod.TPA-7) • **FR** Plaque gaz lisse chromée SUPERCHROME (Moca Approved), sur armoire ouvert, plaque cm.56x51 (inclus 1 Élément de jonction top mod.TPA-7) • **ES FRY-TOP GAS LISO CROMADO SUPERCHROME (MOCA APPROVED), SOBRE MUEBLE ABIERTO, PLANCHA CM.56X51 (INCLUIDA 1 CHAPA DE CIERRE PARA TOP MOD.TPA-7)**

cm. 60x 70,5x 90h

$\frac{10,5 \text{ kW}}{9.030 \text{ kcal/h}}$ **3.454,00**
83 / 0,54

FRY-TOP A GAS

MOD. _____
COD. _____

DESCRIZIONE/DESCRIPTION/BEZEICHNUNG/DESCRIPTION/DESCRIPCIÓN
DIMENSIONI/DIMENSIONS/ABMESSUNGEN/DIMENSIONS/DIMENSIONES

POTENZA/POWER/LEISTUNG/PUISSANCE/POTENCIA
VOLTAGGIO/VOLTAGE/SPANNUNG/VOLTAGE/VOLTAJE

10,5 kW
9.030 kcal/h

PREZZO/PRICE
PREIS/PRIX/PRECIO €
KG / M³

FTL-76GSS
08230650 Fry-top gas liscio CROMO LUCIDO, su mobile a giorno, piastra cm.56x51 (inclusa 1 testata chiusura piano mod.TPA-7)
EN Gas Fry-top smooth POLISHED CHROME, on open cabinet, plate cm.56x51 (included 1 Head end filler strip mod.TPA-7) • **DE** Gas-griddleplatte glatt POLIERTEM CHROM, mit offenem Unterbau, platte cm.56x51 (inbegriffen 1 Abschluss-Element mod.TPA-7) • **FR** Plaque gaz lisse CHROME POLI, sur armoire ouvert, plaque cm.56x51 (inclus 1 Élément de jonction top mod.TPA-7) • **ES FRY-TOP GAS LISO CROMO PULIDO, SOBRE MUEBLE ABIERTO, PLANCHA CM.56X51 (INCLUIDA 1 CHAPA DE CIERRE PARA TOP MOD. TPA-7)**
cm. 60x 70,5x 90h



10,5 kW
9.030 kcal/h

3.454,00
83 / 0,54

FTLR-76G
08230652 Fry-top gas 1/2 rigato + 1/2 liscio, su mobile a giorno, piastra cm.56x51 (inclusa 1 testata chiusura piano mod.TPA-7)
EN Gas Fry-top 1/2 grooved + 1/2 smooth, on open cabinet, plate cm.56x51 (included 1 Head end filler strip mod.TPA-7) • **DE** Gas-griddleplatte 1/2 gerillt + 1/2 glatt, mit offenem Unterbau, platte cm.56x51 (inbegriffen 1 Abschluss-Element mod.TPA-7) • **FR** Plaque gaz 1/2 nervurée + 1/2 lisse, sur armoire ouvert, plaque cm.56x51 (inclus 1 Élément de jonction top mod.TPA-7) • **ES FRY-TOP GAS 1/2 ESTRIADO + 1/2 LISO, SOBRE MUEBLE ABIERTO, PLANCHA CM.56X51 (INCLUIDA 1 CHAPA DE CIERRE PARA TOP MOD. TPA-7)**
cm. 60x 70,5x 90h

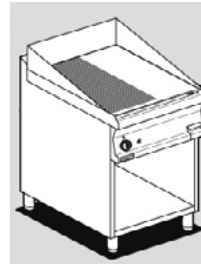

10,5 kW
9.030 kcal/h

2.974,00
83 / 0,54

FTLR-76GS
08230655 Fry-top gas 1/2 rigato + 1/2 liscio cromato SUPERCHROME (Moca Approved), su mobile a giorno, piastra cm.56x51 (inclusa 1 testata chiusura piano mod.TPA-7)
EN Gas Fry-top 1/2 grooved + 1/2 smooth chromed griddle SUPERCHROME (Moca Approved), on open cabinet, plate cm.56x51 (included 1 Head end filler strip mod.TPA-7) • **DE** Gas-griddleplatte 1/2 gerillt + 1/2 glatt hartverchromt SUPERCHROME (Moca Approved), mit offenem Unterbau, platte cm.56x51 (inbegriffen 1 Abschluss-Element mod.TPA-7) • **FR** Plaque gaz 1/2 nervurée + 1/2 lisse chromée SUPERCHROME (Moca Approved), sur armoire ouvert, plaque cm.56x51 (inclus 1 Élément de jonction top mod.TPA-7) • **ES FRY-TOP GAS 1/2 ESTRIADO + 1/2 LISO CROMADO SUPERCHROME (MOCA APPROVED), SOBRE MUEBLE ABIERTO, PLANCHA CM.56X51 (INCLUIDA 1 CHAPA DE CIERRE PARA TOP MOD.TPA-7)**
cm. 60x 70,5x 90h

10,5 kW
9.030 kcal/h

3.597,00
83 / 0,54

FTR-76G
08230653 Fry-top gas rigato, su mobile a giorno, piastra cm.56x51 (inclusa 1 testata chiusura piano mod.TPA-7)
EN Gas Fry-top grooved griddle, on open cabinet, plate cm.56x51 (included 1 Head end filler strip mod.TPA-7) • **DE** Gas-griddleplatte gerillt, mit offenem Unterbau, platte cm.56x51 (inbegriffen 1 Abschluss-Element mod.TPA-7) • **FR** Plaque gaz nervurée, sur armoire ouvert, plaque cm.56x51 (inclus 1 Élément de jonction top mod.TPA-7) • **ES FRY-TOP GAS ESTRIADO, SOBRE MUEBLE ABIERTO, PLANCHA CM.56X51 (INCLUIDA 1 CHAPA DE CIERRE PARA TOP MOD. TPA-7)**
cm. 60x 70,5x 90h

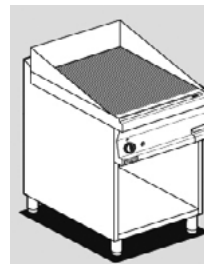

10,5 kW
9.030 kcal/h

3.099,00
83 / 0,54

FTR-76GS
08230656 Fry-top gas rigato cromato SUPERCHROME (Moca Approved), su mobile a giorno, piastra cm.56x51 (inclusa 1 testata chiusura piano mod.TPA-7)
EN Gas Fry-top grooved chromed griddle SUPERCHROME (Moca Approved), on open cabinet, plate cm.56x51 (included 1 Head end filler strip mod.TPA-7) • **DE** Gas-griddleplatte gerillt hartverchromt SUPERCHROME (Moca Approved), mit offenem Unterbau, platte cm.56x51 (inbegriffen 1 Abschluss-Element mod.TPA-7) • **FR** Plaque gaz nervurée chromée SUPERCHROME (Moca Approved), sur armoire ouvert, plaque cm.56x51 (inclus 1 Élément de jonction top mod.TPA-7) • **ES FRY-TOP GAS ESTRIADO CROMADO SUPERCHROME (MOCA APPROVED), SOBRE MUEBLE ABIERTO, PLANCHA CM.56X51 (INCLUIDA 1 CHAPA DE CIERRE PARA TOP MOD.TPA-7)**
cm. 60x 70,5x 90h

10,5 kW
9.030 kcal/h

3.712,00
83 / 0,54

FRY-TOP A GAS

MOD. COD. DESCRIZIONE/DESCRIPTION/BEZEICHNUNG/DESCRIPTION/DESCRIPCIÓN DIMENSIONI/DIMENSIONS/ABMESSUNGEN/DIMENSIONS/DIMENSIONES POTENZA/POWER/LEISTUNG/PUISSANCE/POTENCIA VOLTAGGIO/VOLTAGE/SPANNUNG/VOLTAGE/VOLTAJE $\frac{kW}{kcal/h}$ $\frac{V}{Hz}$ PREZZO/PRICE € PREIS/PRIX/PRECIO €/KG / M³

FTL-78G
08230851

Fry-top gas liscio, su mobile a giorno, piastra cm.76x51 - 2 zone di cottura (inclusa 1 testata chiusura piano mod.TPA-7)
EN Gas Fry-top smooth griddle, on open cabinet, plate cm.76x51 - 2 cooking areas (included 1 Head end filler strip mod.TPA-7) • **DE** Gas-griddleplatte glatt, mit offenem Unterbau, platte cm.76x51 - 2 Heizzonen (inbegriffen 1 Abschluss-Element mod.TPA-7) • **FR** Plaque gaz lisse, sur armoire ouvert, plaque cm.76x51 - 2 zones de cuisson (inclus 1 Élément de jonction top mod.TPA-7) • **ES FRY-TOP GAS LISO, SOBRE MUEBLE ABIERTO, PLANCHA CM.76X51 - 2 ZONAS DE COCCIÓN (INCLUIDA 1 CHAPA DE CIERRE PARA TOP MOD. TPA-7)**
cm. 80x 70,5x 90h



14 kW **3.893,00**
12.040 kcal/h 114 / 0,71

FTL-78GS
08230854

Fry-top gas liscio cromato SUPERCHROME (Moca Approved), su mobile a giorno, piastra cm.76x51 - 2 zone di cottura (inclusa 1 testata chiusura piano mod.TPA-7)
EN Gas Fry-top smooth chromed griddle SUPERCHROME (Moca Approved), on open cabinet, plate cm.76x51 - 2 cooking areas (included 1 Head end filler strip mod.TPA-7) • **DE** Gas-griddleplatte glatt hartverchromt SUPERCHROME (Moca Approved), mit offenem Unterbau, platte cm.76x51 - 2 Heizzonen (inbegriffen 1 Abschluss-Element mod.TPA-7) • **FR** Plaque gaz lisse chromée SUPERCHROME (Moca Approved), sur armoire ouvert, plaque cm.76x51 - 2 zones de cuisson (inclus 1 Élément de jonction top mod.TPA-7) • **ES FRY-TOP GAS LISO CROMADO SUPERCHROME (MOCA APPROVED), SOBRE MUEBLE ABIERTO, PLANCHA CM.76X51 - 2 ZONAS DE COCCIÓN (INCLUIDA 1 CHAPA DE CIERRE PARA TOP MOD.TPA-7)**
cm. 80x 70,5x 90h

14 kW **4.595,00**
12.040 kcal/h 114 / 0,71

FTL-78GSS
08230850

Fry-top gas liscio CROMO LUCIDO, su mobile a giorno, piastra cm.76x51 - 2 zone di cottura (inclusa 1 testata chiusura piano mod.TPA-7)
EN Gas Fry-top smooth POLISHED CHROME, on open cabinet, plate cm.76x51 - 2 cooking areas (included 1 Head end filler strip mod.TPA-7) • **DE** Gas-griddleplatte glatt POLIERTEM CHROM, mit offenem Unterbau, platte cm.76x51 - 2 Heizzonen (inbegriffen 1 Abschluss-Element mod.TPA-7) • **FR** Plaque gaz lisse CHROME POLI, sur armoire ouvert, plaque cm.76x51 - 2 zones de cuisson (inclus 1 Élément de jonction top mod.TPA-7) • **ES FRY-TOP GAS LISO CROMO PULIDO, SOBRE MUEBLE ABIERTO, PLANCHA CM.76X51 - 2 ZONAS DE COCCIÓN (INCLUIDA 1 CHAPA DE CIERRE PARA TOP MOD.TPA-7)**
cm. 80x 70,5x 90h

14 kW **4.595,00**
12.040 kcal/h 114 / 0,71

FTLR-78G
08230852

Fry-top gas 1/2 rigato + 1/2 liscio, su mobile a giorno, piastra cm.76x51 - 2 zone di cottura (inclusa 1 testata chiusura piano mod.TPA-7)
EN Gas Fry-top 1/2 grooved + 1/2 smooth, on open cabinet, plate cm.76x51 - 2 cooking areas (included 1 Head end filler strip mod.TPA-7) • **DE** Gas-griddleplatte 1/2 gerillt + 1/2 glatt, mit offenem Unterbau, platte cm.76x51 - 2 Heizzonen (inbegriffen 1 Abschluss-Element mod.TPA-7) • **FR** Plaque gaz 1/2 nervurée + 1/2 lisse, sur armoire ouvert, plaque cm.76x51 - 2 zones de cuisson (inclus 1 Élément de jonction top mod.TPA-7) • **ES FRY-TOP GAS 1/2 ESTRIADO + 1/2 LISO, SOBRE MUEBLE ABIERTO, PLANCHA CM.76X51 - 2 ZONAS DE COCCIÓN (INCLUIDA 1 CHAPA DE CIERRE PARA TOP MOD.TPA-7)**
cm. 80x 70,5x 90h



14 kW **4.089,00**
12.040 kcal/h 114 / 0,71

FTLR-78GS
08230855

Fry-top gas 1/2 rigato + 1/2 liscio cromato SUPERCHROME (Moca Approved), su mobile a giorno, piastra cm.76x51 - 2 zone di cottura (inclusa 1 testata chiusura piano mod.TPA-7)
EN Gas Fry-top 1/2 grooved + 1/2 smooth chromed griddle SUPERCHROME (Moca Approved), on open cabinet, plate cm.76x51 - 2 cooking areas (included 1 Head end filler strip mod.TPA-7) • **DE** Gas-griddleplatte 1/2 gerillt + 1/2 glatt hartverchromt SUPERCHROME (Moca Approved), mit offenem Unterbau, platte cm.76x51 - 2 Heizzonen (inbegriffen 1 Abschluss-Element mod.TPA-7) • **FR** Plaque gaz 1/2 nervurée + 1/2 lisse chromée SUPERCHROME (Moca Approved), sur armoire ouvert, plaque cm.76x51 - 2 zones de cuisson (inclus 1 Élément de jonction top mod.TPA-7) • **ES FRY-TOP GAS 1/2 ESTRIADO + 1/2 LISO CROMADO SUPERCHROME (MOCA APPROVED), SOBRE MUEBLE ABIERTO, PLANCHA CM.76X51 - 2 ZONAS DE COCCIÓN (INCLUIDA 1 CHAPA DE CIERRE PARA TOP MOD.TPA-7)**
cm. 80x 70,5x 90h

14 kW **4.794,00**
12.040 kcal/h 114 / 0,71

FRY-TOP A GAS

MOD. _____
COD. _____

DESCRIZIONE/DESCRIPTION/BEZEICHNUNG/DESCRIPTION/DESCRIPCIÓN
DIMENSIONI/DIMENSIONS/ABMESSUNGEN/DIMENSIONS/DIMENSIONES

POTENZA/POWER/LEISTUNG/PUISSANCE/POTENCIA
VOLTAGGIO/VOLTAGE/SPANNUNG/VOLTAGE/VOLTAGE

⚡ kW
kcal/h

PREZZO/PRICE
PREIS/PRIX/PRECIO €
KG / M³

FTR-78G
08230853

Fry-top gas rigato, su mobile a giorno, piastra cm.76x51 - 2 zone di cottura (inclusa 1 testata chiusura piano mod.TPA-7)
EN Gas Fry-top grooved griddle, on open cabinet, plate cm.76x51 - 2 cooking areas (included 1 Head end filler strip mod.TPA-7) • **DE** Gas-griddleplatte gerillt, mit offenem Unterbau, platte cm.76x51 - 2 Heizzonen (inbegriffen 1 Abschluss-Element mod.TPA-7) • **FR** Plaque gaz nervurée, sur armoire ouvert, plaque cm.76x51 - 2 zones de cuisson (inclus 1 Élément de jonction top mod.TPA-7) • **ES FRY-TOP GAS ESTRIADO, SOBRE MUEBLE ABIERTO, PLANCHA CM.76X51 - 2 ZONAS DE COCCIÓN (INCLUIDA 1 CHAPA DE CIERRE PARA TOP MOD.TPA-7)**

cm. 80x 70,5x 90h

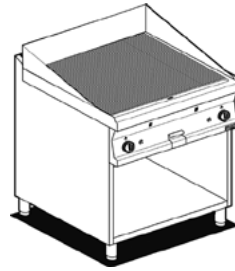

⚡ 14 kW
12.040 kcal/h

4.278,00
114 / 0,71

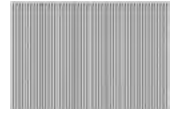

FTR-78GS
08230856

Fry-top gas rigato cromato SUPERCHROME (Moca Approved), su mobile a giorno, piastra cm.76x51 - 2 zone di cottura (inclusa 1 testata chiusura piano mod.TPA-7)

EN Gas Fry-top grooved chromed griddle SUPERCHROME (Moca Approved), on open cabinet, plate cm.76x51 - 2 cooking areas (included 1 Head end filler strip mod.TPA-7) • **DE** Gas-griddleplatte gerillt hartverchromt SUPERCHROME (Moca Approved), mit offenem Unterbau, platte cm.76x51 - 2 Heizzonen (inbegriffen 1 Abschluss-Element mod.TPA-7) • **FR** Plaque gaz nervurée chromée SUPERCHROME (Moca Approved), sur armoire ouvert, plaque cm.76x51 - 2 zones de cuisson (inclus 1 Élément de jonction top mod.TPA-7) • **ES FRY-TOP GAS ESTRIADO CROMADO SUPERCHROME (MOCA APPROVED), SOBRE MUEBLE ABIERTO, PLANCHA CM.76X51 - 2 ZONAS DE COCCIÓN (INCLUIDA 1 CHAPA DE CIERRE PARA TOP MOD.TPA-7)**

cm. 80x 70,5x 90h

⚡ 14 kW
12.040 kcal/h

5.004,00
114 / 0,71

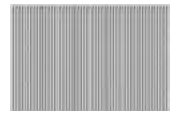

FTL-712G
08231251

Fry-top gas liscio, su mobile a giorno, piastra cm.116x51 - 2 zone di cottura (inclusa 1 testata chiusura piano mod.TPA-7)
EN Gas Fry-top smooth griddle, on open cabinet, plate cm.116x51 - 2 cooking areas (included 1 Head end filler strip mod.TPA-7) • **DE** Gas-griddleplatte glatt, mit offenem Unterbau, platte cm.116x51 - 2 Heizzonen (inbegriffen 1 Abschluss-Element mod.TPA-7) • **FR** Plaque gaz lisse, sur armoire ouvert, plaque cm.116x51 - 2 zones de cuisson (inclus 1 Élément de jonction top mod.TPA-7) • **ES FRY-TOP GAS LISO, SOBRE MUEBLE ABIERTO, PLANCHA CM.116X51 - 2 ZONAS DE COCCIÓN (INCLUIDA 1 CHAPA DE CIERRE PARA TOP MOD.TPA-7)**

cm. 120x 70,5x 90h



⚡ 21 kW
18.060 kcal/h

4.906,00
154 / 1,05



FTL-712GS
08231254

Fry-top gas liscio cromato SUPERCHROME (Moca Approved), su mobile a giorno, piastra cm.116x51 - 2 zone di cottura (inclusa 1 testata chiusura piano mod.TPA-7)

EN Gas Fry-top smooth chromed griddle SUPERCHROME (Moca Approved), on open cabinet, plate cm.116x51 - 2 cooking areas (included 1 Head end filler strip mod.TPA-7) • **DE** Gas-griddleplatte glatt hartverchromt SUPERCHROME (Moca Approved), mit offenem Unterbau, platte cm.116x51 - 2 Heizzonen (inbegriffen 1 Abschluss-Element mod.TPA-7) • **FR** Plaque gaz lisse chromée SUPERCHROME (Moca Approved), sur armoire ouvert, plaque cm.116x51 - 2 zones de cuisson (inclus 1 Élément de jonction top mod.TPA-7) • **ES FRY-TOP GAS LISO CROMADO SUPERCHROME (MOCA APPROVED), SOBRE MUEBLE ABIERTO, PLANCHA CM.116X51 - 2 ZONAS DE COCCIÓN (INCLUIDA 1 CHAPA DE CIERRE PARA TOP MOD.TPA-7)**

cm. 120x 70,5x 90h

⚡ 21 kW
18.060 kcal/h

5.793,00
154 / 1,05



FRY-TOP A GAS

MOD. _____ DESCRIZIONE/DESCRIPTION/BEZEICHNUNG/DESCRIPTION/DESCRIPCIÓN POTENZA/POWER/LEISTUNG/PUISSANCE/POTENCIA ⚡ kW ⚡ kw PREZZO/PRICE €
 COD. _____ DIMENSIONI/DIMENSIONS/ABMESSUNGEN/DIMENSIONS/DIMENSIONES VOLTAGGIO/VOLTAGE/SPANNUNG/VOLTAGE/VOLTAJE kcal/h V~ Hz PREIS/PRIX/PRECIO € KG / M³

FTLR-712G Fry-top gas 1/2 rigato + 1/2 liscio, su mobile a giorno, piastra cm.116x51 - 2 zone di cottura (inclusa 1 testata chiusura piano mod. TPA-7)
 08231252 **EN** Gas Fry-top 1/2 grooved + 1/2 smooth, on open cabinet, plate cm.116x51 - 2 cooking areas (included 1 Head end filler strip mod.TPA-7)
 • **DE** Gas-griddleplatte 1/2 gerillt + 1/2 glatt, mit offenem Unterbau, platte cm.116x51 - 2 Heizzonen (inbegriffen 1 Abschluss-Element mod. TPA-7) • **FR** Plaque gaz 1/2 nervurée + 1/2 lisse, sur armoire ouvert, plaque cm.116x51 - 2 zones de cuisson (inclus 1 Élément de jonction top mod.TPA-7) • **ES FRY-TOP GAS 1/2 ESTRIADO + 1/2 LISO, SOBRE MUEBLE ABIERTO, PLANCHA CM.116X51 - 2 ZONAS DE COCCIÓN (INCLUIDA 1 CHAPA DE CIERRE PARA TOP MOD.TPA-7)**
cm. 120x 70,5x 90h

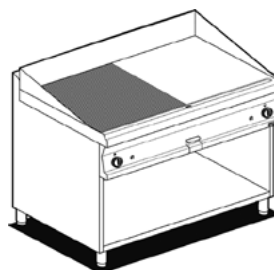

⚡ 21 kW **5.152,00**
 18.060 kcal/h 154 / 1,05



FTLR-712GS Fry-top gas 1/2 rigato + 1/2 liscio cromato SUPERCHROME (Moca Approved), su mobile a giorno, piastra cm.116x51 - 2 zone di cottura (inclusa 1 testata chiusura piano mod.TPA-7)
 08231255 **EN** Gas Fry-top 1/2 grooved + 1/2 smooth chromed griddle SUPERCHROME (Moca Approved), on open cabinet, plate cm.116x51 - 2 cooking areas (included 1 Head end filler strip mod.TPA-7) • **DE** Gas-griddleplatte 1/2 gerillt + 1/2 glatt hartverchromt SUPERCHROME (Moca Approved), mit offenem Unterbau, platte cm.116x51 - 2 Heizzonen (inbegriffen 1 Abschluss-Element mod.TPA-7) • **FR** Plaque gaz 1/2 nervurée + 1/2 lisse chromée SUPERCHROME (Moca Approved), sur armoire ouvert, plaque cm.116x51 - 2 zones de cuisson (inclus 1 Élément de jonction top mod.TPA-7) • **ES FRY-TOP GAS 1/2 ESTRIADO + 1/2 LISO CROMADO SUPERCHROME (MOCA APPROVED), SOBRE MUEBLE ABIERTO, PLANCHA CM.116X51 - 2 ZONAS DE COCCIÓN (INCLUIDA 1 CHAPA DE CIERRE PARA TOP MOD.TPA-7)**
cm. 120x 70,5x 90h

⚡ 21 kW **5.996,00**
 18.060 kcal/h 154 / 1,05



FTR-712G Fry-top gas rigato, su mobile a giorno, piastra cm.116x51 - 2 zone di cottura (inclusa 1 testata chiusura piano mod.TPA-7)
 08231253 **EN** Gas Fry-top grooved griddle, on open cabinet, plate cm.116x51 - 2 cooking areas (included 1 Head end filler strip mod.TPA-7) • **DE** Gas-griddleplatte gerillt, mit offenem Unterbau, platte cm.116x51 - 2 Heizzonen (inbegriffen 1 Abschluss-Element mod.TPA-7) • **FR** Plaque gaz nervurée, sur armoire ouvert, plaque cm.116x51 - 2 zones de cuisson (inclus 1 Élément de jonction top mod.TPA-7) • **ES FRY-TOP GAS ESTRIADO, SOBRE MUEBLE ABIERTO, PLANCHA CM.116X51 - 2 ZONAS DE COCCIÓN (INCLUIDA 1 CHAPA DE CIERRE PARA TOP MOD.TPA-7)**
cm. 120x 70,5x 90h

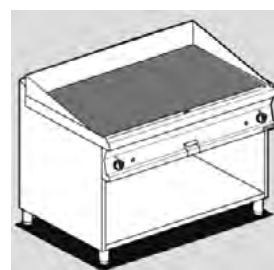

⚡ 21 kW **5.401,00**
 18.060 kcal/h 154 / 1,05



FTR-712GS Fry-top gas rigato cromato SUPERCHROME (Moca Approved), su mobile a giorno, piastra cm.116x51 - 2 zone di cottura (inclusa 1 testata chiusura piano mod.TPA-7)
 08231256 **EN** Gas Fry-top grooved chromed griddle SUPERCHROME (Moca Approved), on open cabinet, plate cm.116x51 - 2 cooking areas (included 1 Head end filler strip mod.TPA-7) • **DE** Gas-griddleplatte gerillt hartverchromt SUPERCHROME (Moca Approved), mit offenem Unterbau, platte cm.116x51 - 2 Heizzonen (inbegriffen 1 Abschluss-Element mod. TPA-7) • **FR** Plaque gaz nervurée chromée SUPERCHROME (Moca Approved), sur armoire ouvert, plaque cm.116x51 - 2 zones de cuisson (inclus 1 Élément de jonction top mod.TPA-7) • **ES FRY-TOP GAS ESTRIADO CROMADO SUPERCHROME (MOCA APPROVED), SOBRE MUEBLE ABIERTO, PLANCHA CM.116X51 - 2 ZONAS DE COCCIÓN (INCLUIDA 1 CHAPA DE CIERRE PARA TOP MOD.TPA-7)**
cm. 120x 70,5x 90h

⚡ 21 kW **6.259,00**
 18.060 kcal/h 154 / 1,05



FRY-TOP A GAS

MOD. _____
COD. _____

DESCRIZIONE/DESCRIPTION/BEZEICHNUNG/DESCRIPTION/DESCRIPCIÓN
DIMENSIONI/DIMENSIONS/ABMESSUNGEN/DIMENSIONS/DIMENSIONES

POTENZA/POWER/LEISTUNG/PUISSANCE/POTENCIA
VOLTAGGIO/VOLTAGE/SPANNUNG/VOLTAGE/VOLTAJE

⚡ kW
kcal/h

⚡ kW
V- Hz

PREZZO/PRICE €
PREIS/PRIX/PRECIO €
KG / M³

FTL-712G3
0823125B

Fry-top gas liscio, su mobile a giorno, piastra cm.116x51 - 3 zone di cottura (inclusa 1 testata chiusura piano mod.TPA-7)
EN Gas Fry-top smooth griddle, on open cabinet, plate cm.116x51 - 3 cooking areas (included 1 Head end filler strip mod.TPA-7) • **DE** Gas-griddleplatte glatt, mit offenem Unterbau, platte cm.116x51 - 3 Heizzonen (inbegriffen 1 Abschluss-Element mod.TPA-7) • **FR** Plaque gaz lisse, sur armoire ouvert, plaque cm.116x51 - 3 zones de cuisson (inclus 1 Elément de jonction top mod.TPA-7) • **ES FRY-TOP GAS LISO, SOBRE MUEBLE ABIERTO, PLANCHA CM.116X51 - 3 ZONAS DE COCCIÓN (INCLUIDA 1 CHAPA DE CIERRE PARA TOP MOD. TPA-7)**
cm. 120x 70,5x 90h



⚡ 21 kW
18.060 kcal/h

5.283,00
154 / 1,05



FTL-712GS3
0823125E

Fry-top gas liscio cromato SUPERCHROME (Moca Approved), su mobile a giorno, piastra cm.116x51 - 3 zone di cottura (inclusa 1 testata chiusura piano mod.TPA-7)
EN Gas Fry-top smooth chromed griddle SUPERCHROME (Moca Approved), on open cabinet, plate cm.116x51 - 3 cooking areas (included 1 Head end filler strip mod.TPA-7) • **DE** Gas-griddleplatte glatt hartverchromt SUPERCHROME (Moca Approved), mit offenem Unterbau, platte cm.116x51 - 3 Heizzonen (inbegriffen 1 Abschluss-Element mod.TPA-7) • **FR** Plaque gaz lisse chromée SUPERCHROME (Moca Approved), sur armoire ouvert, plaque cm.116x51 - 3 zones de cuisson (inclus 1 Elément de jonction top mod.TPA-7) • **ES FRY-TOP GAS LISO CROMADO SUPERCHROME (MOCA APPROVED), SOBRE MUEBLE ABIERTO, PLANCHA CM.116X51 - 3 ZONAS DE COCCIÓN (INCLUIDA 1 CHAPA DE CIERRE PARA TOP MOD. TPA-7)**
cm. 120x 70,5x 90h

⚡ 21 kW
18.060 kcal/h

6.151,00
154 / 1,05



FTL-712GSS3
0823125Y

Fry-top gas liscio CROMO LUCIDO, su mobile a giorno, piastra cm.116x51 - 3 zone di cottura (inclusa 1 testata chiusura piano mod. TPA-7)
EN Gas Fry-top smooth POLISHED CHROME, on open cabinet, plate cm.116x51 - 3 cooking areas (included 1 Head end filler strip mod.TPA-7) • **DE** Gas-griddleplatte glatt POLIERTEM CHROM, mit offenem Unterbau, platte cm.116x51 - 3 Heizzonen (inbegriffen 1 Abschluss-Element mod. TPA-7) • **FR** Plaque gaz lisse CHROME POLI, sur armoire ouvert, plaque cm.116x51 - 3 zones de cuisson (inclus 1 Elément de jonction top mod. TPA-7) • **ES FRY-TOP GAS LISO CROMO PULIDO, SOBRE MUEBLE ABIERTO, PLANCHA CM.116X51 - 3 ZONAS DE COCCIÓN (INCLUIDA 1 CHAPA DE CIERRE PARA TOP MOD. TPA-7)**
cm. 120x 70,5x 90h

⚡ 21 kW
18.060 kcal/h

6.151,00
154 / 1,05

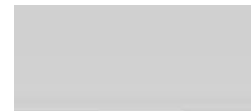

FTLR-712G3
0823125C

Fry-top gas 1/3 rigato + 2/3 liscio, su mobile a giorno, piastra cm.116x51 - 3 zone di cottura (inclusa 1 testata chiusura piano mod. TPA-7)
EN Gas Fry-top 1/3 grooved + 2/3 smooth, on open cabinet, plate cm.116x51 - 3 cooking areas (included 1 Head end filler strip mod.TPA-7) • **DE** Gas-griddleplatte 1/3 gerillt + 2/3 glatt, mit offenem Unterbau, platte cm.116x51 - 3 Heizzonen (inbegriffen 1 Abschluss-Element mod. TPA-7) • **FR** Plaque gaz 1/3 nervurée + 2/3 lisse, sur armoire ouvert, plaque cm.116x51 - 3 zones de cuisson (inclus 1 Elément de jonction top mod.TPA-7) • **ES FRY-TOP GAS 1/3 ESTRIADO + 2/3 LISO, SOBRE MUEBLE ABIERTO, PLANCHA CM.116X51 - 3 ZONAS DE COCCIÓN (INCLUIDA 1 CHAPA DE CIERRE PARA TOP MOD.TPA-7)**
cm. 120x 70,5x 90h



⚡ 21 kW
18.060 kcal/h

5.411,00
154 / 1,05



FRY-TOP A GAS

MOD. COD. DESCRIZIONE / DESCRIPTION / BEZEICHNUNG / DESCRIPCIÓN DIMENSIONI / DIMENSIONS / ABMESSUNGEN / DIMENSIONS / DIMENSIONES POTENZA / POWER / LEISTUNG / PUISSANCE / POTENCIA VOLTAGGIO / VOLTAGE / SPANNUNG / VOLTAGE / VOLTAJE kW kcal/h $\frac{kW}{V \sim}$ Hz PREZZO / PRICE € PREIS / PRIX / PRECIO KG / M³

FTLR-712GS3 Fry-top gas 1/3 rigato + 2/3 liscio cromato SUPERCHROME (Moca Approved), su mobile a giorno, piastra cm.116x51 - 3 zone di cottura (inclusa 1 testata chiusura piano mod.TPA-7)
EN Gas Fry-top 1/3 grooved + 2/3 smooth chromed SUPERCHROME (Moca Approved), on open cabinet, plate cm.116x51 - 3 cooking areas (included 1 Head end filler strip mod.TPA-7) • **DE** Gas-griddleplatte 1/3 gerillt + 2/3 glatt hartverchromt SUPERCHROME (Moca Approved), mit offenem Unterbau, platte cm.116x51 - 3 Heizzonen (inbegriffen 1 Abschluss-Element mod.TPA-7) • **FR** Plaque gaz 1/3 nervurée + 2/3 lisse chromée AW770:AW833pproved), sur armoire ouvert, plaque cm.116x51 - 3 zones de cuisson (inclus 1 Élément de jonction top mod.TPA-7) • **ES FRY-TOP GAS 1/3 ESTRIADO + 2/3 LISO CROMADO SUPERCHROME (MOCA APPROVED), SOBRE MUEBLE ABIERTO, PLANCHA CM.116X51 - 3 ZONAS DE COCCIÓN (INCLUIDA 1 CHAPA DE CIERRE PARA TOP MOD. TPA-7)**
cm. 120x 70,5x 90h



21 kW
18.060 kcal/h

6.358,00
154 / 1,05



RSFT-73EM Piastra per sandwich sopra frytop elettrici - Piastra cm. 29x40 (ATTENZIONE: PROFONDITA' MACCHINA +cm.10)
EN Sandwiches plate above electric griddle - plate cm. 29x40 (ATTENTION: DEPTH MACHINE +cm.10) • **DE** Sandwiches Platte über Elektrische Griddle - platte cm. 29x40 (VORSICHT: TIEFE MACHINE +cm.10) • **FR** Plaque pour sandwichs au-dessus électrique fry-top - plaque cm. 29x40 (ATTENTION: PROFONDEUR MACHINE +cm.10) • **ES PLANCIA PARA SÁNDWICHES SOBRE FRY-TOP ELÉCTRICO - PLANCIA CM. 29X40 (ATENCIÓN: PROFUNDIDAD MÁQUINA +CM.10)**
cm. 32x 62x 41h



2,9 KW
230V~
50/60 Hz

1.493,00
20 / 0,21

CWK-74ET GRIGLIA CONTACT SU MOBILE A GIORNO - cottura diretta su resistenza in acciaio inox cm. 27x43 ribaltabile (inclusa 1 testata chiusura piano mod.TPA-7)
EN CONTACT Grill threephase on open cabinet - rotatable stainless steel grill cm. 27x43 (included 1 Head end filler strip mod.TPA-7) • **DE** Wurstbrater dreiphasig KONTAKT mit offenem Unterbau - Drehbaren Heizelement aus Edelstahl cm. 27x43 (inbegriffen 1 Abschluss-Element mod.TPA-7) • **FR** Grillade triphase CONTACT sur armoire ouvert- Grille inox rotatif cm 27x43 (inclus 1 Élément de jonction top mod.TPA-7) • **ES PARRILLA TRIFÁSICO CONTACT SOBRE MUEBLE ABIERTO - PARRILLA GIRATORIA DE ACERO INOX CM 27X43 (INCLUIDA 1 CHAPA DE CIERRE PARA TOP MOD.TPA-7)**
cm. 40x 70,5x 90h



4,08 KW
400V~3N
50/60 Hz

3.320,00
60 / 0,37

CWK-78ET GRIGLIA CONTACT SU MOBILE A GIORNO - cottura diretta su resistenza in acciaio inox cm. 55x43 ribaltabile - 2 zone cottura (inclusa 1 testata chiusura piano mod.TPA-7)
EN CONTACT Grill threephase on open cabinet - rotatable stainless steel grill cm. 55x43 - 2 cooking areas (included 1 Head end filler strip mod.TPA-7) • **DE** Wurstbrater dreiphasig KONTAKT mit offenem Unterbau - Drehbaren Heizelement aus Edelstahl cm. 55x43 - 2 Heizzonen (inbegriffen 1 Abschluss-Element mod.TPA-7) • **FR** Grillade triphase CONTACT sur armoire ouvert- Grille inox rotatif cm 55x43 - 2 zones de cuisson (inclus 1 Élément de jonction top mod.TPA-7) • **ES PARRILLA TRIFÁSICO CONTACT SOBRE MUEBLE ABIERTO - PARRILLA GIRATORIA DE ACERO INOX CM 55X43 - 2 ZONAS DE COCCIÓN (INCLUIDA 1 CHAPA DE CIERRE PARA TOP MOD. TPA-7)**
cm. 80x 70,5x 90h

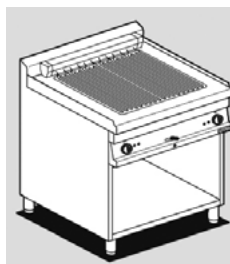

8,16 KW
400V~3N
50/60 Hz

4.288,00
90 / 0,71

CW-74ET GRIGLIA TRIFASE SU MOBILE A GIORNO Griglia in acciaio inox cm. 38x52 regolabile (inclusa 1 testata chiusura piano mod.TPA-7)
EN Grill threephase on open cabinet Stainless steel grill cm. 38x52 (included 1 Head end filler strip mod.TPA-7) • **DE** Wurstbrater dreiphasig mit offenem Unterbau Einstellbarer Rost aus Nirosta cm. 38x52 (inbegriffen 1 Abschluss-Element mod.TPA-7) • **FR** Grillade triphase sur armoire ouvert Grille inox cm 38x52 (inclus 1 Élément de jonction top mod.TPA-7) • **ES PARRILLA TRIFÁSICO SOBRE MUEBLE ABIERTO PARRILLA DE ACERO INOX REGULABLE CM 38X52 (INCLUIDA 1 CHAPA DE CIERRE PARA TOP MOD.TPA-7)**
cm. 40x 70,5x 90h



6 kW
400V~3N
230V~3
50/60 Hz

2.554,00
62 / 0,40

GRIGLIE ELETTRICHE

MOD. _____
COD. _____

DESCRIZIONE/DESCRIPTION/BEZEICHNUNG/DESCRIPTION/DESCRIPCIÓN
DIMENSIONI/DIMENSIONS/ABMESSUNGEN/DIMENSIONS/DIMENSIONES

POTENZA/POWER/LEISTUNG/PUISSANCE/POTENCIA
VOLTAGGIO/VOLTAGE/SPANNUNG/VOLTAGE/VOLTAJE

⚡ kW
kcal/h

PREZZO/PRICE
PREIS/PRIX/PRECIO €
KG / M³

CW-78ET
08080830

GRIGLIA TRIFASE SU MOBILE A GIORNO N. 2 griglie in acciaio inox cm. 38x52 regolabili 2 zone di cottura (inclusa 1 testata chiusura piano mod. TPA-7)
EN Grill threephase on open cabinet N. 2 Stainless steel grill cm. 38x52. 2 cooking areas (included 1 Head end filler strip mod.TPA-7) • **DE** Wurstbrater dreiphasig mit offenem Unterbau - Nr. 2 einstellbare Roste aus Nirosta cm. 38x52 - 2 Heizzonen (inbegriffen 1 Abschluss-Element mod. TPA-7) • **FR** Grillade triphase sur armoire ouvert N. 2 grilles réglables en acier inox cm. 38x52 2 zones de cuisson (inclus 1 Élément de jonction top mod.TPA-7) • **ES PARRILLA TRIFÁSICO SOBRE MUEBLE ABIERTO - N. 2 PARRILLAS DE ACERO INOX REGULABLE CM 38X52 - 2 ZONAS DE COCCIÓN (INCLUIDA 1 CHAPA DE CIERRE PARA TOP MOD.TPA-7)**
cm. 80x 70,5x 90h



⚡ 12 kW
400V~3N
230V~3
50/60 Hz

3.595,00
94 / 0,78

CW-74G
08250450

GRIGLIA GAS-PIETRALAVICA SU MOBILE A GIORNO Griglia in acciaio inox cm. 38x52 regolabile (inclusa 1 testata chiusura piano mod.TPA-7)
EN Charcoal grill gas on open cabinet Stainless steel grill cm. 38x52 (included 1 Head end filler strip mod.TPA-7) • **DE** Gas-Lavasteingrill mit offenem Unterbau Einstellbarer Rost aus Nirosta cm. 38x52 (inbegriffen 1 Abschluss-Element mod.TPA-7) • **FR** Grille à gaz en pierre de lave sur armoire ouvert Grille inox cm 38x52 (inclus 1 Élément de jonction top mod.TPA-7) • **ES PARRILLA A GAS PIEDRA LÁVICA SOBRE MUEBLE ABIERTO PARRILLA DE ACERO INOX REGULABLE CM 38X52 (INCLUIDA 1 CHAPA DE CIERRE PARA TOP MOD. TPA-7)**
cm. 40x 70,5x 90h



⚡ 9 kW
7.740 kcal/h

2.586,00
61 / 0,40

CW-78G
08250850

GRIGLIA GAS-PIETRALAVICA SU MOBILE A GIORNO N. 2 griglie in acciaio inox cm. 38x52 regolabili 2 zone di cottura. (inclusa 1 testata chiusura piano mod.TPA-7)
EN Charcoal grill gas on open cabinet N. 2 Stainless steel grill cm. 38x52. 2 cooking areas (included 1 Head end filler strip mod.TPA-7) • **DE** Gas-Lavasteingrill mit offenem Unterbau - N. 2 einstellbare Roste aus Nirosta cm. 38x52 - 2 Heizzonen (inbegriffen 1 Abschluss-Element mod.TPA-7) • **FR** Grille a gaz en pierre de lave sur armoire ouvert. N. 2 grilles réglables en acier inox cm. 38x52. 2 zones de cuisson (inclus 1 Élément de jonction top mod.TPA-7) • **ES PARRILLA A GAS PIEDRA LÁVICA SOBRE MUEBLE ABIERTO N. 2 PARRILLAS DE ACERO INOX REGULABLE CM 38X52 2 ZONAS DE COCCIÓN (INCLUIDA 1 CHAPA DE CIERRE PARA TOP MOD.TPA-7)**
cm. 80x 70,5x 90h



⚡ 18 kW
15.480 kcal/h

3.887,00
104 / 0,78

F2/8-74ET
08090432

FRIGGITRICE TRIFASE LT. 8+8 2 Vasche cm. 14,8x35x32,7h - 2 cesti cm. 12x30x15h - Filtro e coperchio vasca. 2 Bacinelle raccogliolio con filtro. Produzione patate: 12 kg/h (inclusa 1 testata chiusura piano mod.TPA-7)
EN Fryer threephase 8+8 lts - 2 Bowls cm. 14,8x35x32,7h - 2 baskets cm. 12x30x15h. Sieve and lid for pan. 2 drip tray with sieves. Production: 12 kg/h (included 1 Head end filler strip mod.TPA-7) • **DE** Friteuse dreiphasig lt. 8+8 - 2 Becken cm. 14,8x35x32,7h - 2 Korb cm. 12x30x15h. Einlegesieb und Deckel für Becken. 2 Fettaufangschalen mit Sieb. Pommes frites: 12 kg/h (inbegriffen 1 Abschluss-Element mod.TPA-7) • **FR** Friteuse triphase lt. 8+8 - 2 Cuve cm. 14,8x35x32,7h - 2 Panier cm. 12x30x15h. Filtre, couvercle pour cuve. 2 bacs de récupération de l'huile avec filtre. Production de pommes frites: 12 kg/h (inclus 1 Élément de jonction top mod.TPA-7) • **ES FREIDORAS TRIFÁSICO 8+8 LT. - 2CUBA CM. 14,8X35X32,7H - 2 CESTA CM. 12X30X15H. FILTRO Y TAPA PARA CUBA. 2 BANDEJAS RECOGE ACEITE CON FILTRO. PROD. PATATAS: 12 KG/H (INCLUIDA 1 CHAPA DE CIERRE PARA TOP MOD.TPA-7)**
cm. 40x 70,5x 90h



⚡ 12 kW
400V~3N
230V~3
50/60 Hz

3.749,00
59 / 0,37

FRIGGITRICI ELETTRICHE

MOD. _____ DESCRIZIONE/DESCRIPTION/BEZEICHNUNG/DESCRIPTION/DESCRIPCIÓN POTENZA/POWER/LEISTUNG/PUISSANCE/POTENCIA $\frac{kW}{kcal/h}$ $\frac{kW}{V\sim}$ PREZZO/PRICE €
 COD. _____ DIMENSIONI/DIMENSIONS/ABMESSUNGEN/DIMENSIONS/DIMENSIONES VOLTAGGIO/VOLTAGE/SPANNUNG/VOLTAGE/VOLTAGE KG / M³

F13-74ET FRIGGITRICE TRIFASE LT. 13 Vasca cm. 24x35x38h - 1 cesto cm.
 08090430 21x30x12h - Filtro e coperchio vasca. Bacinella raccogliolio con filtro.
 Produzione patate: 10 kg/h (inclusa 1 testata chiusura piano mod.TPA-7)
EN Fryer threephase 13 lts - Bowl cm. 24x35x38h - 1 basket cm.
 21x30x12h. Sieve and lid for pan. Drip tray with sieve. Production:
 10 kg/h (included 1 Head end filler strip mod.TPA-7) • **DE** Friteuse
 dreiphasig lt. 13 - Becken cm. 24x35x38h - 1 Korb cm. 21x30x12h.
 Einlegesieb und Deckel für Becken. Fettauffangschale mit Sieb. Pommes
 frites: 10 kg/h (inbegriffen 1 Abschluss-Element mod.TPA-7) • **FR**
 Friteuse triphase lt. 13 - Cuve cm. 24x35x38h - 1 Panier cm. 21x30x12h.
 Filtre, couvercle pour cuve. Bac de récupération de l'huile avec filtre.
 Production de pommes frites: 10 kg/h (inclus 1 Élément de jonction top
 mod.TPA-7) • **ES FREIDORAS TRIFÁSICO 13 LT. - CUBA CM.**
24X35X38H - 1 CESTA CM. 21X30X12H. FILTRO Y TAPA
PARA CUBA. BANDEJA RECOGE ACEITE CON FILTRO. PROD.
PATATAS: 10 KG/H (INCLUIDA 1 CHAPA DE CIERRE PARA TOP
MOD.TPA-7)
cm. 40x 70,5x 90h



⚡ 10,95 kW **2.702,00**
 400V~3N 54 / 0,37
 50/60 Hz

F18-74ET FRIGGITRICE TRIFASE LT. 18 Vasca cm. 31x34x33h - 1 cesto cm.
 08090431 28x29x15h - Filtro e coperchio vasca. Bacinella raccogliolio con filtro.
 Produzione patate: 15 kg/h (inclusa 1 testata chiusura piano mod.TPA-7)
EN Fryer threephase 18 lts - Bowl cm. 31x34x33h - 1 basket cm.
 28x29x15h. Sieve and lid for pan. Drip tray with sieve. Production:
 15 kg/h (included 1 Head end filler strip mod.TPA-7) • **DE** Friteuse
 dreiphasig lt. 18 - Becken cm. 31x34x33h - 1 Korb cm. 28x29x15h.
 Einlegesieb und Deckel für Becken. Fettauffangschale mit Sieb. Pommes
 frites: 15 kg/h (inbegriffen 1 Abschluss-Element mod.TPA-7) • **FR**
 Friteuse triphase lt. 18 - Cuve cm. 31x34x33h - 1 Panier cm. 28x29x15h.
 Filtre, couvercle pour cuve. Bac de récupération de l'huile avec filtre.
 Production de pommes frites: 15 kg/h (inclus 1 Élément de jonction top
 mod.TPA-7) • **ES FREIDORAS TRIFÁSICO 18 LT. - CUBA CM.**
31X34X33H - 1 CESTA CM. 28X29X15H. FILTRO Y TAPA
PARA CUBA. BANDEJA RECOGE ACEITE CON FILTRO. PROD.
PATATAS: 15 KG/H (INCLUIDA 1 CHAPA DE CIERRE PARA TOP
MOD.TPA-7)
cm. 40x 70,5x 90h

⚡ 15,9 kW **2.926,00**
 400V~3N 57 / 0,37
 50/60 Hz

F2/13-78ET FRIGGITRICE TRIFASE LT. 13+13 2 vasche cm. 24x35x38h - 2 cesti cm.
 08090830 21x30x12h 2 filtri e coperchi vasche. 2 bacinelle raccogliolio con filtro.
 Produzione patate: 20 kg/h (inclusa 1 testata chiusura piano mod.TPA-7)
EN Fryer threephase 13+13 lts - 2 pans cm. 24x35x38h 2 baskets
 cm. 21x30x12h. 2 sieve and lids for pan. 2 drip trays with sieves.
 Production: 20 kg/h (included 1 Head end filler strip mod.TPA-7) • **DE**
 Friteuse dreiphasig lt. 13+13 - 2 Becken cm. 24x35x38h 2 Körbe cm.
 21x30x12h. Einlegesieb und Deckel für Becken. 2 Fettauffangschalen mit
 Sieb. Pommes frites: 20 kg/h (inbegriffen 1 Abschluss-Element mod.TPA-7)
 • **FR** Friteuse triphase lt. 13+13 - 2 cuves cm. 24x35x38h 2 paniers cm.
 21x30x12h. 2 filtres, couvercles pour cuve. 2 bacs de récupération de
 l'huile avec filtre. Production de pommes frites: 20 kg/h (inclus 1 Élément
 de jonction top mod.TPA-7) • **ES FREIDORAS TRIFÁSICO 13+13 LT.**
- 2 CUBAS CM. 24X35X38H 2 CESTAS CM. 21X30X12H. 2
FILTROS Y TAPAS PARA CUBAS. 2 BANDEJAS RECOGE ACEITE
CON FILTRO. PROD. PATATAS: 20 KG/H (INCLUIDA 1 CHAPA
DE CIERRE PARA TOP MOD.TPA-7)
cm. 80x 70,5x 90h



⚡ 21,9 kW **4.046,00**
 400V~3N 95 / 0,71
 50/60 Hz

F2/18-78ET FRIGGITRICE TRIFASE LT. 18+18 2 vasche cm. 31x34x33h - 2 cesti cm.
 08090831 28x29x15h 2 filtri e coperchi vasche. 2 bacinelle raccogliolio con filtro.
 Produzione patate: 30 kg/h (inclusa 1 testata chiusura piano mod.TPA-7)
EN Fryer threephase 18+18 lts - 2 pans cm. 31x34x33h 2 baskets
 cm. 28x29x15h. 2 sieve and lids for pan. 2 drip trays with sieves.
 Production: 30 kg/h (included 1 Head end filler strip mod.TPA-7) • **DE**
 Friteuse dreiphasig lt. 18+18 - 2 Becken cm. 31x34x33h 2 Körbe cm.
 28x29x15h. Einlegesieb und Deckel für Becken. 2 Fettauffangschalen mit
 Sieb. Pommes frites: 30 kg/h (inbegriffen 1 Abschluss-Element mod.TPA-7)
 • **FR** Friteuse triphase lt. 18+18 - 2 cuves cm. 31x34x33h 2 paniers cm.
 28x29x15h. 2 filtres, couvercles pour cuve. 2 bacs de récupération de
 l'huile avec filtre. Production de pommes frites: 30 kg/h (inclus 1 Élément
 de jonction top mod.TPA-7) • **ES FREIDORAS TRIFÁSICO 18+18 LT.**
- 2 CUBAS CM. 31X34X33H 2 CESTAS CM. 28X29X15H. 2
FILTROS Y TAPAS PARA CUBA. 2 BANDEJAS RECOGE ACEITE
CON FILTRO. PROD. PATATAS: 30 KG/H (INCLUIDA 1 CHAPA
DE CIERRE PARA TOP MOD.TPA-7)
cm. 80x 70,5x 90h



⚡ 31,8 kW **4.499,00**
 400V~3N 97 / 0,71
 50/60 Hz

FRIGGITRICI ELETTRICHE

MOD. _____
COD. _____

DESCRIZIONE/DESCRIPTION/BEZEICHNUNG/DESCRIPTION/DESCRIPCIÓN
DIMENSIONI/DIMENSIONS/ABMESSUNGEN/DIMENSIONS/DIMENSIONES

POTENZA/POWER/LEISTUNG/PUISSANCE/POTENCIA
VOLTAGGIO/VOLTAGE/SPANNUNG/VOLTAGE/VOLTAJE

⚡ kW _____
kcal/h _____
V~ _____
Hz _____

PREZZO/PRICE €
PREIS/PRIX/PRECIO €
KG / M³

F45-78ET
08090835

FRIGGITRICE TRIFASE LT. 45 Vasca cm. 70x38x38h - 1 cesto cm. 65x33x17h - Filtro e coperchio vasca. Bacinella raccogliolio con filtro. Produzione patate: 40 kg/h (inclusa 1 testata chiusura piano mod.TPA-7)
EN Fryer threephase 45 lts - Bowl cm. 70x38x38h - 1 basket cm. 65x33x17h. Sieve and lid for pan. Drip tray with sieve. Production: 40 kg/h (included 1 Head end filler strip mod.TPA-7) • **DE** Friteuse dreiphasig lt. 45 - Becken cm. 70x38x38h - 1 Korb cm. 65x33x17h. Einlegesieb und Deckel für Becken. Fettauffangschale mit Sieb. Pommes frites: 40 kg/h (inbegriffen 1 Abschluss-Element mod.TPA-7) • **FR** Friteuse triphase lt. 45 - Cuve cm. 70x38x38h - 1 Panier cm. 65x33x17h. Filtre, couvercle pour cuve. Bac de récupération de l'huile avec filtre. Production de pommes frites: 40 kg/h (inclus 1 Élément de jonction top mod.TPA-7) • **ES FREIDORAS TRIFÁSICO 45 LT. - CUBA CM. 70X38X38H - 1 CESTA CM. 65X33X17H. FILTRO Y TAPA PARA CUBA. BANDEJA RECOGE ACEITE CON FILTRO. PROD. PATATAS: 40 KG/H (INCLUIDA 1 CHAPA DE CIERRE PARA TOP MOD.TPA-7)**
cm. **80x 70,5x 90h**



⚡ 40 kW _____ **5.109,00**
400V~3N _____ 96 / 0,71
50/60 Hz

F2/8-74G
08260452

FRIGGITRICE GAS LT. 8+8 - 2 vasche cm. 15x35x36h 2 cesti cm. 12x30x15h. Filtro e coperchio vasca. 2 bacinelle raccogliolio con filtro. Prod. patate: 12 kg/h (inclusa 1 testata chiusura piano mod.TPA-7)
EN Gas Fryer 8+8 lts - 2 pans cm. 15x35x36h 2 baskets cm. 12x30x15h. Sieve and lid for pan. 2 drip trays with sieves. Production: 12 kg/h (included 1 Head end filler strip mod.TPA-7) • **DE** Gas-Friteuse lt. 8+8 - 2 Becken cm. 15x35x36h 2 Körbe cm. 12x30x15h. Einlegesieb und Deckel für Becken. 2 Fettauffangschalen mit Sieb. Pommes frites: 12 kg/h (inbegriffen 1 Abschluss-Element mod.TPA-7) • **FR** Friteuse à gaz lt. 8+8 - 2 cuves cm. 15x35x36h 2 paniers cm. 12x30x15h. Filtre, couvercle pour cuve. 2 bacs de récupération de l'huile avec filtre. Production de pommes frites: 12 kg/h (inclus 1 Élément de jonction top mod.TPA-7) • **ES FREIDORAS A GAS 8+8 LT. - 2 CUBAS CM. 15X35X36H 2 CESTAS CM. 12X30X15H. FILTRO Y TAPA PARA CUBA. 2 BANDEJAS RECOGE ACEITE CON FILTRO. PROD. PATATAS: 12 KG/H (INCLUIDA 1 CHAPA DE CIERRE PARA TOP MOD.TPA-7)**
cm. **40x 70,5x 90h**



⚡ 10 kW _____ **4.335,00**
8.600 kcal/h _____ 59 / 0,37

F13-74G
08260450

FRIGGITRICE GAS LT. 13 Vasca cm. 24x35x38h - 1 cesto cm. 21x30x12h. Filtro e coperchio vasca. Bacinella raccogliolio con filtro. Prod. patate: 10 kg/h (includo entrambe le testate chiusura piano)
EN Gas Fryer 13 lts - Bowl cm. 24x35x38h - 1 basket cm. 21x30x12h. Sieve and lid for pan. Drip tray with sieve. Production: 10 kg/h (included both Heads end filler strip) • **DE** Gas-Friteuse lt. 13 - Becken cm. 24x35x38h - 1 Korb cm. 21x30x12h. Einlegesieb und Deckel für Becken. Fettauffangschale mit Sieb. Pommes frites: 10 kg/h (inbegriffen alle 2 Abschluss-Element) • **FR** Friteuse a gaz lt. 13 - Cuve cm. 24x35x38h - 1 Panier cm. 21x30x12h. Filtre, couvercle pour cuve. Bac de récupération de l'huile avec filtre. Production de pommes frites: 10 kg/h (inclus tous 2 Élément de jonction top) • **ES FREIDORAS A GAS 13 LT. - CUBA CM. 24X35X38H - 1 CESTA CM. 21X30X12H. FILTRO Y TAPA PARA CUBA. BANDEJA RECOGE ACEITE CON FILTRO. PROD. PATATAS: 10 KG/H (INCLUIDAS TODAS LAS 2 CHAPA DE CIERRE PARA TOP)**
cm. **40x 70,5x 90h**



⚡ 9,3 kW _____ **2.750,00**
8.000 kcal/h _____ 61 / 0,40

F18-74G
08260451

FRIGGITRICE GAS LT. 18 Vasca cm. 33x38x38h. - 1 cesto cm. 30x33x12h. Filtro e coperchio vasca. Bacinella raccogliolio con filtro. Prod. patate: 15 kg/h (includo entrambe le testate chiusura piano)
EN Gas Fryer 18 lts - Bowl cm. 33x38x38h - 1 basket cm. 30x33x12h. Sieve and lid for pan. Drip tray with sieve. Production: 15 kg/h (included both Heads end filler strip) • **DE** Gas-Friteuse lt. 18 - Becken cm. 33x38x38h - 1 Korb cm. 30x33x12h. Einlegesieb und Deckel für Becken. Fettauffangschale mit Sieb. Pommes frites: 15 kg/h (inbegriffen alle 2 Abschluss-Element) • **FR** Friteuse a gaz lt. 18 - Cuve cm. 33x38x38h 1 Panier cm. 30x33x12h. Filtre, couvercle pour cuve. - Bac de récupération de l'huile avec filtre. Production de pommes frites: 15 kg/h (inclus tous 2 Élément de jonction top) • **ES FREIDORAS A GAS 18 LT. - CUBA CM. 33X38X38H - 1 CESTA CM. 30X33X12H. FILTRO Y TAPA PARA CUBA. BANDEJA RECOGE ACEITE CON FILTRO. PROD. PATATAS: 15 KG/H (INCLUIDAS TODAS LAS 2 CHAPA DE CIERRE PARA TOP)**
cm. **40x 70,5x 90h**

⚡ 13,5 kW _____ **3.063,00**
11.610 kcal/h _____ 66 / 0,40

FRIGGITRICI A GAS

MOD. COD.	DESCRIZIONE/DESCRIPTION/BEZEICHNUNG/DESCRIPTION/DESCRIPCIÓN DIMENSIONI/DIMENSIONS/ABMESSUNGEN/DIMENSIONS/DIMENSIONES	POTENZA/POWER/LEISTUNG/PUISSANCE/POTENCIA VOLTAGGIO/VOLTAGE/SPANNUNG/VOLTAGE/VOLTAJE	$\frac{kW}{kcal/h}$ $\frac{V\sim}{Hz}$	PREZZO/PRICE € KG / M ³
---------------------	---	---	---	--

F2/13-78G FRIGGITRICE GAS LT. 13+13 - 2 vasche cm. 24x35x38h 2 cesti cm. 21x30x12h. 2 filtri e coperchi vasche. 2 bacinelle raccogliolio con filtro. Prod. patate: 20 kg/h (include entrambe le testate chiusura piano)
EN Gas Fryer 13+13 lts - 2 pans cm. 24x35x38h 2 baskets cm. 21x30x12h. 2 sieve and lids for pan. 2 drip trays with sieves. Production: 20 kg/h (included both Heads end filler strip) • **DE** Gas-Friteuse lt. 13+13 - 2 Becken cm. 24x35x38h 2 Körbe cm. 21x30x12h. Einlegesieb und Deckel für Becken. 2 Fettauffangschalen mit Sieb. Pommes frites: 20 kg/h (inbegriffen alle 2 Abschluss-Element) • **FR** Friteuse à gaz lt. 13+13 - 2 cuves cm. 24x35x38h 2 paniers cm. 21x30x12h. 2 filtres, couvercles pour cuve. 2 bacs de récupération de l'huile avec filtre. Production de pommes frites: 20 kg/h (inclus tous 2 Elément de jonction top) • **ES FREIDORAS A GAS 13+13 LT. - 2 CUBAS CM. 24X35X38H 2 CESTAS CM. 21X30X12H. 2 FILTROS Y TAPAS PARA CUBAS. 2 BANDEJAS RECOGE ACEITE CON FILTRO. PROD. PATATAS: 20 KG/H (INCLUIDAS TODAS LAS 2 CHAPA DE CIERRE PARA TOP)**
cm. 80x 70,5x 90h



18,6 kW
16.000 kcal/h

4.877,00
102 / 0,78

F2/18-78G FRIGGITRICE GAS LT. 18+18 - 2 vasche cm. 33x38x38h 2 cesti cm. 30x33x12h. 2 filtri e coperchi vasche. 2 bacinelle raccogliolio con filtro. Prod. patate: 30 kg/h (include entrambe le testate chiusura piano)
EN Gas Fryer 18+18 lts - 2 pans cm. 33x38x38h 2 baskets cm. 30x33x12h. 2 sieve and lids for pan. 2 drip trays with sieves. Production: 30 kg/h (included both Heads end filler strip) • **DE** Gas-Friteuse lt. 18+18 - 2 Becken cm. 33x38x38h 2 Körbe cm. 30x33x12h. Einlegesieb und Deckel für Becken. 2 Fettauffangschalen mit Sieb. Pommes frites: 30 kg/h (inbegriffen alle 2 Abschluss-Element) • **FR** Friteuse à gaz lt. 18+18 - 2 cuves cm. 33x38x38h 2 paniers cm. 30x33x12h. 2 filtres, couvercles pour cuve. 2 bacs de récupération de l'huile avec filtre. Production de pommes frites: 30 kg/h (inclus tous 2 Elément de jonction top) • **ES FREIDORAS A GAS 18+18 LT. - 2 CUBAS CM. 33X38X38H 2 CESTAS CM. 30X33X12H. 2 FILTROS Y TAPAS PARA CUBA. 2 BANDEJAS RECOGE ACEITE CON FILTRO. PROD. PATATAS: 30 KG/H (INCLUIDAS TODAS LAS 2 CHAPA DE CIERRE PARA TOP)**
cm. 80x 70,5x 90h

27 kW
23.220 kcal/h

5.368,00
111 / 0,78

F45-78G FRIGGITRICE GAS LT. 45 Vasca cm. 70x38x38h. - 1 cesto cm. 65x33x17h. Filtro e coperchio vasca. Bacinella raccogliolio con filtro. Prod. patate: 40 kg/h (include entrambe le testate chiusura piano)
EN Gas Fryer 45 lts - Bowl cm. 70x38x38h - 1 basket cm. 65x33x17h. Sieve and lid for pan. Drip tray with sieve. Production: 40 kg/h (included both Heads end filler strip) • **DE** Gas-Friteuse lt. 45 - Becken cm. 70x38x38h - 1 Korb cm. 65x33x17h. Einlegesieb und Deckel für Becken. Fettauffangschale mit Sieb. Pommes frites: 40 kg/h (inbegriffen alle 2 Abschluss-Element) • **FR** Friteuse a gaz lt. 45 - Cuve cm. 70x38x38h - 1 Panier cm. 65x33x17h. Filtre, couvercle pour cuve. Bac de récupération de l'huile avec filtre. Production de pommes frites: 40 kg/h (inclus tous 2 Elément de jonction top) • **ES FREIDORAS A GAS 45 LT. - CUBA CM. 70X38X38H - 1 CESTA CM. 65X33X17H. FILTRO Y TAPA PARA CUBA. BANDEJA RECOGE ACEITE CON FILTRO. PROD. PATATAS: 40 KG/H (INCLUIDAS TODAS LAS 2 CHAPA DE CIERRE PARA TOP)**
cm. 80x 70,5x 90h



44 kW
37.840 kcal/h

6.071,00
110 / 1,07

0,005 kW
230V~
50 Hz

FRIGGITRICI ELETTRICHE DIGITALI

MOD. _____
COD. _____

DESCRIZIONE/DESCRIPTION/BEZEICHNUNG/DESCRIPTION/DESCRIPCIÓN
DIMENSIONI/DIMENSIONS/ABMESSUNGEN/DIMENSIONS/DIMENSIONES

POTENZA/POWER/LEISTUNG/PUISSANCE/POTENCIA
VOLTAGGIO/VOLTAGE/SPANNUNG/VOLTAGE/VOLTAJE

⚡ kW _____
kcal/h _____
V~ _____
Hz _____

PREZZO/PRICE € _____
PREIS/PRIX/PRECIO € _____
KG / M³ _____

F18-74ETD
0815A430

FRIGGITRICE ELETTRICA ELETTRONICA con TouchScreen 7".
Conservazione a 110 °C o Prelavoro a 160 °C con o senza Melting.
Possibilità di inserire in memoria fino a 100 programmi. Sensore
presenza e livello massimo olio. Vasca 18 litri cm.31x34x33h - 2 cesti
cm.13,5x29x21h - Filtro e coperchio vasca. Bacinella raccolta olio con
supporto su ruote. Produzione patate: 27 kg/h (inclusa 1 testata chiusura
piano mod.TPA-7)

EN Electric electronic Fryer with a 7" TouchScreen. Conservation at
110 °C and preworking at 160 °C with or without Melting. Possibility
to store in the memory up to 100 programs. Oil presence sensor
and maximum level sensor. Bowl 18 lts cm.31x34x33h - 2 baskets
cm.13,5x29x21h. Sieve and lid for pan. Oil collection basin with support
on wheels. Production: 27 kg/h (included 1 Head end filler strip mod.
TPA-7) • **DE** ELEKTRONISCHE ELEKTRISCHE FRITEUSE mit TouchScreen
7". Aufbewahrung bei 110 °C oder Vorbearbeitung bei 160 °C mit
oder ohne Melting. Es können bis zu 100 Programme gespeichert
werden. Anwesenheits- sowie maximaler Ölstandsensoren. Becken 18 lt.
cm.31x34x33h - 2 Körbe cm.13,5x29x21h. Einlegesieb und Deckel
für Becken. Ölauffangbecken mit Halterung auf Rädern. Pommes frites:
27 kg/h (inbegriffen 1 Abschluss-Element mod.TPA-7) • **FR** FRITEUSE
ÉLECTRIQUE ÉLECTRONIQUE à Écran tactile 7". Conservation à 110 °C
ou Pré-traitement à 160 °C avec ou sans Melting. Possibilité d'enregistrer
jusqu'à 100 programmes en mémoire. Capteur de présence et de niveau
maximal huile. Cuve 18 lt. cm.31x34x33h - 2 Paniers cm.13,5x29x21h.
Filtre, couvercle pour cuve. Bassine de collecte de l'huile avec support
sur roues. Production de pommes frites: 27 kg/h (inclus 1 Élément de
jonction top mod.TPA-7) • **ES** FREIDORA ELÉCTRICA ELECTRÓNICA
**CON PANTALLA TÁCTIL DE 7". CONSERVACIÓN A 110 °C O TRABAJO PREVIO A 160 °C CON O SIN FUSIÓN. SE
PUEDEN ALMACENAR HASTA 100 PROGRAMAS EN LA
MEMORIA. SENSOR DE PRESENCIA Y NIVEL MÁXIMO DE
ACEITE. CUBA DE 18 LITROS CM. 31X34X33H - 2 CESTAS
CM.13,5X29X21H. FILTRO Y TAPA PARA CUBA. CUBETA DE
RECOGIDA DE ACEITE CON SOPORTE SOBRE RUEDAS. PROD.
PATATAS: 27 KG/H (INCLUIDA 1 CHAPA DE CIERRE PARA TOP
MOD.TPA-7)
cm. 40x 70,5x 90h**



⚡ 15,95 kW _____ **6.640,00**
400V~3N _____ 63 / 0,40
50/60 Hz _____

FRIGGITRICI ELETTRICHE DIGITALI

MOD.
COD.

DESCRIZIONE/DESCRIPTION/BEZEICHNUNG/DESCRIPTION/DESCRIPCIÓN
DIMENSIONI/DIMENSIONS/ABMESSUNGEN/DIMENSIONS/DIMENSIONES

POTENZA/POWER/LEISTUNG/PUISSANCE/POTENCIA
VOLTAGGIO/VOLTAGE/SPANNUNG/VOLTAGE/VOLTAJE

⚡ kW
kcal/h

⚡ kw
V~
Hz

PREZZO/PRICE €
PREIS/PRIX/PRECIO €
KG / M³

F18-74ETDP
0815A431

FRIGGITRICE ELETTRICA ELETTRONICA con TouchScreen 7".
Conservazione a 110 °C o Prelavoro a 160 °C con o senza Melting.
Possibilità di inserire in memoria fino a 100 programmi. Sensore presenza
e livello massimo olio. Pompa filtraggio olio a caldo max 180°C, pulizia
vasca, svuotamento vasca. Vasca 18 litri cm.31x34x33h - 2 cesti
cm.13,5x29x21h - Filtro e coperchio vasca. Bacinella raccolta olio con
supporto su ruote e filtro 5 micron (pz.100 inclusi). Produzione patate: 27
kg/h (inclusa 1 testata chiusura piano mod.TPA-7)

EN Electric electronic Fryer with a 7" TouchScreen. Conservation at 110
°C and preworking at 160 °C with or without Melting. Possibility to store
in the memory up to 100 programs. Oil presence sensor and maximum
level sensor. Pump for filter the hot oil max 180°C, Tank cleaning, Tank
emptying. Bowl 18 lts cm.31x34x33h - 2 baskets cm.13,5x29x21h. Sieve
and lid for pan. Oil collection basin with support on wheels with sieve 5
microns (pcs.100 included). Production: 27 kg/h (included 1 Head end
filler strip mod.TPA-7) • **DE** ELEKTRONISCHE ELEKTRISCHE FRITEUSE
mit TouchScreen 7". Aufbewahrung bei 110 °C oder Vorbearbeitung
bei 160 °C mit oder ohne Melting. Es können bis zu 100 Programme
gespeichert werden. Anwesenheits- sowie maximaler Ölstandsensor.
Heißölfilterpumpe max 180°C, Tankreinigung, Tankentleerung. Becken 18
lt. cm.31x34x33h - 2 Körbe cm.13,5x29x21h. Einlegesieb und Deckel für
Becken. Ölauffangbecken mit Halterung auf Rädern und 5-Mikron-Filter
(Stk.100 inbegriffen). Pommes frites: 27 kg/h (inbegriffen 1 Abschluss-
Element mod.TPA-7) • **FR** FRITEUSE ÉLECTRIQUE ÉLECTRONIQUE
à Écran tactile 7". Conservation à 110 °C ou Pré-traitement à 160 °C
avec ou sans Melting. Possibilité d'enregistrer jusqu'à 100 programmes
en mémoire. Capteur de présence et de niveau maximal huile. Pompe
filtration huile à chaud max 180°C, nettoyage cuve, vidange cuve.
Cuve 18 lt. cm.31x34x33h - 2 Paniers cm.13,5x29x21h. Filtre, couvercle
pour cuve. Bassine de collecte de l'huile avec support sur roues et filtre 5
microns (pcs.100 inclus). Production de pommes frites: 27 kg/h (inclus
1 Élément de jonction top mod.TPA-7) • **ES** FREIDORA ELÉCTRICA
ELECTRÓNICA CON PANTALLA TÁCTIL DE 7". CONSERVACIÓN
A 110 °C O TRABAJO PREVIO A 160 °C CON O SIN FUSIÓN.
SE PUEDEN ALMACENAR HASTA 100 PROGRAMAS EN
LA MEMORIA. SENSOR DE PRESENCIA Y NIVEL MÁXIMO
DE ACEITE. BOMBA DE FILTRADO DE ACEITE CALIENTE,
MÁXIMO 180 °C, LIMPIEZA DEL TANQUE, VACIADO DEL
TANQUE. CUBA DE 18 LITROS CM. 31X34X33H - 2 CESTAS
CM.13,5X29X21H. FILTRO Y TAPA PARA CUBA. CUBETA
DE RECOGIDA DE ACEITE CON SOPORTE SOBRE RUEDAS Y
FILTRO DE 5 MICRONES (PZ.100 INCLUIDA). PROD. PATATAS:
27 KG/H (INCLUIDA 1 CHAPA DE CIERRE PARA TOP MOD.
TPA-7)

cm. 40x 70,5x 90h



⚡ 16,2 kW **10.228,00**
400V~3N 73 / 0,40
50/60 Hz

FRIGGITRICI ELETTRICHE DIGITALI

MOD. _____
COD. _____

DESCRIZIONE/DESCRIPTION/BEZEICHNUNG/DESCRIPTION/DESCRIPCIÓN
DIMENSIONI/DIMENSIONS/ABMESSUNGEN/DIMENSIONS/DIMENSIONES

POTENZA/POWER/LEISTUNG/PUISSANCE/POTENCIA
VOLTAGGIO/VOLTAGE/SPANNUNG/VOLTAGE/VOLTAJE

⚡ kW kcal/h ⚡ kW V- Hz

PREZZO/PRICE €
PREIS/PRIX/PRECIO €
KG / M³

F18-74ETDPS
0815A432

FRIGGITRICE ELETTRICA ELETTRONICA con TouchScreen 7".
Conservazione a 110 °C o Prelavoro a 160 °C con o senza Melting.
Possibilità di inserire in memoria fino a 100 programmi. Sensore presenza e livello massimo olio. Pompa filtraggio olio a caldo max 180°C, pulizia vasca, svuotamento vasca. 2 sollevatori cesti integrati. Vasca 18 litri cm.31x34x33h - 2 cesti cm.13,5x29x21h - Filtro e coperchio vasca. Bacinella raccolta olio con supporto su ruote e filtro 5 micron (pz.100 inclusi). Produzione patate: 27 kg/h (inclusa 1 testata chiusura piano mod.TPA-7)

EN Electric electronic Fryer with a 7" TouchScreen. Conservation at 110 °C and preworking at 160 °C with or without Melting. Possibility to store in the memory up to 100 programs. Oil presence sensor and maximum level sensor. Pump for filter the hot oil max 180°C, Tank cleaning, Tank emptying. 2 Lifter for baskets integrated. Bowl 18 lts cm.31x34x33h - 2 baskets cm.13,5x29x21h. Sieve and lid for pan. Oil collection basin with support on wheels with sieve 5 microns (pcs.100 included). Production: 27 kg/h (included 1 Head end filler strip mod. TPA-7) • **DE** ELEKTRONISCHE ELEKTRISCHE FRITSEUSE mit TouchScreen 7". Aufbewahrung bei 110 °C oder Vorbearbeitung bei 160 °C mit oder ohne Melting. Es können bis zu 100 Programme gespeichert werden. Anwesenheits- sowie maximaler Ölstandsensoren. Heißölfilterpumpe max 180°C, Tankreinigung, Tankentleerung. Integrierte 2 Korbheber. Becken 18 lt. cm.31x34x33h - 2 Körbe cm.13,5x29x21h. Einlegesieb und Deckel für Becken. Ölauffangbecken mit Halterung auf Rädern und 5-Mikron-Filter (Stk.100 inbegriffen). Pommes frites: 27 kg/h (inbegriffen 1 Abschluss-Element mod.TPA-7) • **FR** FRITSEUSE ÉLECTRIQUE ÉLECTRONIQUE à Écran tactile 7". Conservation à 110 °C ou Pré-traitement à 160 °C avec ou sans Melting. Possibilité d'enregistrer jusqu'à 100 programmes en mémoire. Capteur de présence et de niveau maximal huile. Pompe filtration huile à chaud max 180°C, nettoyage cuve, vidange cuve. 2 Élévateurs paniers intégrés. Cuve 18 lt. cm.31x34x33h - 2 Paniers cm.13,5x29x21h. Filtre, couvercle pour cuve. Bassine de collecte de l'huile avec support sur roues et filtre 5 microns (pcs.100 inclus). Production de pommes frites: 27 kg/h (inclus 1 Élément de jonction top mod.TPA-7) • **ES** FREIDORA ELÉCTRICA ELECTRÓNICA CON PANTALLA TÁCTIL DE 7". CONSERVACIÓN A 110 °C O TRABAJO PREVIO A 160 °C CON O SIN FUSIÓN. SE PUEDEN ALMACENAR HASTA 100 PROGRAMAS EN LA MEMORIA. SENSOR DE PRESENCIA Y NIVEL MÁXIMO DE ACEITE. BOMBA DE FILTRADO DE ACEITE CALIENTE, MÁXIMO 180 °C, LIMPIEZA DEL TANQUE, VACIADO DEL TANQUE. 2 ELEVADORES DE CESTA INTEGRADOS. CUBA DE 18 LITROS CM. 31X34X33H - 2 CESTAS CM.13,5X29X21H. FILTRO Y TAPA PARA CUBA. CUBETA DE RECOGIDA DE ACEITE CON SOPORTE SOBRE RUEDAS Y FILTRO DE 5 MICRONES (PZ.100 INCLUIDA). PROD. PATATAS: 27 KG/H (INCLUIDA 1 CHAPA DE CIERRE PARA TOP MOD.TPA-7)
cm. 40x 70,5x 90h



⚡ 16,55 kW 12.740,00
400V~3N 83 / 0,40
50/60 Hz

FRIGGITRICI ELETTRICHE DIGITALI

MOD. COD.	DESCRIZIONE/DESCRIPTION/BEZEICHNUNG/DESCRIPTION/DESCRIPCIÓN DIMENSIONI/DIMENSIONS/ABMESSUNGEN/DIMENSIONS/DIMENSIONES	POTENZA/POWER/LEISTUNG/PUISSANCE/POTENCIA VOLTAGGIO/VOLTAGE/SPANNUNG/VOLTAGE/VOLTAGE	$\frac{\text{kW}}{\text{kcal/h}}$ $\frac{\text{kw}}{\text{V~}}$ Hz	PREZZO/PRICE € PREIS/PRIX/PRECIO KG / M ³
---------------------	---	---	---	---

F2/18-78ETD FRIGGITRICE ELETTRICA ELETTRONICA con TouchScreen 7".
0815A830 Conservazione a 110 °C o Prelavoro a 160 °C con o senza Melting. Possibilità di inserire in memoria fino a 100 programmi. Sensore presenza e livello massimo olio. 2 vasche 18 litri cm.31x34x33h - 4 cesti cm.13,5x29x21h - Filtri e coperchi vasche. 2 bacinelle raccolta olio con supporto su ruote. Produzione patate: 54 kg/h (inclusa 1 testata chiusura piano mod.TPA-7)

EN Electric electronic Fryer with a 7" TouchScreen. Conservation at 110 °C and preworking at 160 °C with or without Melting. Possibility to store in the memory up to 100 programs. Oil presence sensor and maximum level sensor. 2 bowls 18 lts cm.31x34x33h - 4 baskets cm.13,5x29x21h. 2 Sieve and lid for pan. 2 Oil collection basin with support on wheels. Production: 54 kg/h (included 1 Head end filler strip mod.TPA-7) • **DE** ELEKTRONISCHE ELEKTRISCHE FRITEUSE mit TouchScreen 7". Aufbewahrung bei 110 °C oder Vorbearbeitung bei 160 °C mit oder ohne Melting. Es können bis zu 100 Programme gespeichert werden. Anwesenheits- sowie maximaler Ölstandsensor. 2 Becken 18 lt. cm.31x34x33h - 4 Körbe cm.13,5x29x21h. 2 Einlegesieb und Deckel für Becken. Ölauffangbecken mit Halterung auf Rädern. Pommes frites: 54 kg/h (inbegriffen 1 Abschluss-Element mod.TPA-7) • **FR** FRITEUSE ÉLECTRIQUE ÉLECTRONIQUE à Écran tactile 7". Conservation à 110 °C ou Pré-traitement à 160 °C avec ou sans Melting. Possibilité d'enregistrer jusqu'à 100 programmes en mémoire. Capteur de présence et de niveau maximal huile. 2 Cuves 18 lt. cm.31x34x33h - 4 Paniers cm.13,5x29x21h. 2 Filtre, couvercle pour cuve. 2 Bassine de collecte de l'huile avec support sur roues. Production de pommes frites: 54 kg/h (inclus 1 Élément de jonction top mod.TPA-7) • **ES** FREIDORA ELÉCTRICA ELECTRÓNICA CON PANTALLA TÁCTIL DE 7". CONSERVACIÓN A 110 °C O TRABAJO PREVIO A 160 °C CON O SIN FUSIÓN. SE PUEDEN ALMACENAR HASTA 100 PROGRAMAS EN LA MEMORIA. SENSOR DE PRESENCIA Y NIVEL MÁXIMO DE ACEITE. 2 CUBAS DE 18 LITROS CM. 31X34X33H - 4 CESTAS CM.13,5X29X21H. 2 FILTROS Y TAPAS PARA CUBA. 2 CUBETAS DE RECOGIDA DE ACEITE CON SOPORTE SOBRE RUEDAS. PROD. PATATAS: 54 KG/H (INCLUIDA 1 CHAPA DE CIERRE PARA TOP MOD.TPA-7)

cm. 80x 70,5x 90h



⚡ 31,9 kW **12.030,00**
400V~3N 109 / 0,78
50/60 Hz

FRIGGITRICI ELETTRICHE DIGITALI

MOD. _____
COD. _____

DESCRIZIONE/DESCRIPTION/BEZEICHNUNG/DESCRIPTION/DESCRIPCIÓN
DIMENSIONI/DIMENSIONS/ABMESSUNGEN/DIMENSIONS/DIMENSIONES

POTENZA/POWER/LEISTUNG/PUISSANCE/POTENCIA
VOLTAGGIO/VOLTAGE/SPANNUNG/VOLTAGE/VOLTAJE

⚡ kW _____
kcal/h _____
V~ _____
Hz _____

PREZZO/PRICE € _____
PREIS/PRIX/PRECIO _____
KG / M³ _____

F2/18-78ETDP
0815A831

FRIGGITRICE ELETTRICA ELETTRONICA con TouchScreen 7".
Conservazione a 110 °C o Prelavoro a 160 °C con o senza Melting.
Possibilità di inserire in memoria fino a 100 programmi. Sensore presenza e livello massimo olio. 2 pompe filtraggio olio a caldo max 180°C, pulizia vasca, svuotamento vasca. 2 vasche 18 litri cm.31x34x33h - 4 cesti cm.13,5x29x21h - Filtri e coperchi vasche. 2 bacinelle raccolta olio con supporto su ruote e filtro 5 micron (pz.100 inclusi). Produzione patate: 54 kg/h (inclusa 1 testata chiusura piano mod.TPA-7)

EN Electric electronic Fryer with a 7" TouchScreen. Conservation at 110 °C and preworking at 160 °C with or without Melting. Possibility to store in the memory up to 100 programs. Oil presence sensor and maximum level sensor. 2 Pump for filter the hot oil max 180°C, Tank cleaning, Tank emptying. 2 bowls 18 lts cm.31x34x33h - 4 baskets cm.13,5x29x21h. 2 Sieve and lid for pan. 2 Oil collection basin with support on wheels with sieve 5 microns (pcs.100 included). Production: 54 kg/h (included 1 Head end filler strip mod.TPA-7) • **DE** ELEKTRONISCHE ELEKTRISCHE FRITEUSE mit TouchScreen 7". Aufbewahrung bei 110 °C oder Vorbearbeitung bei 160 °C mit oder ohne Melting. Es können bis zu 100 Programme gespeichert werden. Anwesenheits- sowie maximaler Ölstandsensor. 2 Heißölfilterpumpe max 180°C, Tankreinigung, Tankentleerung. 2 Becken 18 lt. cm.31x34x33h - 4 Körbe cm.13,5x29x21h. 2 Einlegesieb und Deckel für Becken. 2 Ölauffangbecken mit Halterung auf Rädern und 5-Mikron-Filter (Stk.100 inbegriffen). Pommes frites: 54 kg/h (inbegriffen 1 Abschluss-Element mod.TPA-7) • **FR** FRITEUSE ÉLECTRIQUE ÉLECTRONIQUE à Écran tactile 7". Conservation à 110 °C ou Pré-traitement à 160 °C avec ou sans Melting. Possibilité d'enregistrer jusqu'à 100 programmes en mémoire. Capteur de présence et de niveau maximal huile. 2 Pompe filtration huile à chaud max 180°C, nettoyage cuve, vidange cuve. 2 Cuves 18 lt. cm.31x34x33h - 4 Paniers cm.13,5x29x21h. 2 Filtre, couvercle pour cuve. 2 Bassine de collecte de l'huile avec support sur roues et filtre 5 microns (pcs.100 inclus). Production de pommes frites: 54 kg/h (inclus 1 Élément de jonction top mod.TPA-7) • **ES** FREIDORA ELÉCTRICA ELECTRÓNICA CON PANTALLA TÁCTIL DE 7". CONSERVACIÓN A 110 °C O TRABAJO PREVIO A 160 °C CON O SIN FUSIÓN. SE PUEDEN ALMACENAR HASTA 100 PROGRAMAS EN LA MEMORIA. SENSOR DE PRESENCIA Y NIVEL MÁXIMO DE ACEITE. 2 BOMBA DE FILTRADO DE ACEITE CALIENTE, MÁXIMO 180 °C, LIMPIEZA DEL TANQUE, VACIADO DEL TANQUE. 2 CUBAS DE 18 LITROS CM. 31X34X33H - 4 CESTAS CM.13,5X29X21H. 2 FILTROS Y TAPAS PARA CUBA. 2 CUBETAS DE RECOGIDA DE ACEITE CON SOPORTE SOBRE RUEDAS Y FILTRO DE 5 MICRONES (PZ.100 INCLUIDA). PROD. PATATAS: 54 KG/H (INCLUIDA 1 CHAPA DE CIERRE PARA TOP MOD.TPA-7)
cm. 80x 70,5x 90h



⚡ 32,4 kW _____ **19.207,00**
400V~3N _____ 129 / 0,78
50/60 Hz _____

FRIGGITRICI ELETTRICHE DIGITALI

MOD. _____ DESCRIZIONE/DESCRIPTION/BEZEICHNUNG/DESCRIPTION/DESCRIPCIÓN POTENZA/POWER/LEISTUNG/PUISSANCE/POTENCIA ⚡ kW ⚡ kw PREZZO/PRICE €
 COD. _____ DIMENSIONI/DIMENSIONS/ABMESSUNGEN/DIMENSIONS/DIMENSIONES VOLTAGGIO/VOLTAGE/SPANNUNG/VOLTAGE/VOLTAJE kcal/h V~ Hz PREIS/PRIX/PRECIO €
 KG / M³

F2/18-78ETDPS FRIGGITRICE ELETTRICA ELETTRONICA con TouchScreen 7".
 0815A832 Conservazione a 110 °C o Prelavoro a 160 °C con o senza Melting. Possibilità di inserire in memoria fino a 100 programmi. Sensore presenza e livello massimo olio. 2 pompe filtraggio olio a caldo max 180°C, pulizia vasca, svuotamento vasca. 4 sollevatori cesti integrati. 2 vasche 18 litri cm.31x34x33h - 4 cesti cm.13,5x29x21h - Filtri e coperchi vasche. 2 bacinelle raccolta olio con supporto su ruote e filtro 5 micron (pz.100 inclusi). Produzione patate: 54 kg/h (inclusa 1 testata chiusura piano mod.TPA-7)



⚡ 33,1 kW **24.231,00**
 400V~3N 149 / 0,78
 50/60 Hz

EN Electric electronic Fryer with a 7" TouchScreen. Conservation at 110 °C and preworking at 160 °C with or without Melting. Possibility to store in the memory up to 100 programs. Oil presence sensor and maximum level sensor. 2 Pump for filter the hot oil max 180°C, Tank cleaning, Tank emptying. 4 Lifter for baskets integrated. 2 bowls 18 lts cm.31x34x33h - 4 baskets cm.13,5x29x21h. 2 Sieve and lid for pan. 2 Oil collection basin with support on wheels with sieve 5 microns (pcs.100 included). Production: 54 kg/h (included 1 Head end filler strip mod. TPA-7) • **DE** ELEKTRONISCHE ELEKTRISCHE FRITEUSE mit TouchScreen 7". Aufbewahrung bei 110 °C oder Vorbearbeitung bei 160 °C mit oder ohne Melting. Es können bis zu 100 Programme gespeichert werden. Anwesenheits- sowie maximaler Ölstandsensor. 2 Heißölfilterpumpe max 180°C, Tankreinigung, Tankentleerung. Integrierte 4 Korbheber. 2 Becken 18 lt. cm.31x34x33h - 4 Körbe cm.13,5x29x21h. 2 Einlegesieb und Deckel für Becken. 2 Ölauffangbecken mit Halterung auf Rädern und 5-Mikron-Filter (Stk.100 inbegriffen). Pommes frites: 54 kg/h (inbegriffen 1 Abschluss-Element mod.TPA-7) • **FR** FRITEUSE ÉLECTRIQUE ÉLECTRONIQUE à Écran tactile 7". Conservation à 110 °C ou Pré-traitement à 160 °C avec ou sans Melting. Possibilité d'enregistrer jusqu'à 100 programmes en mémoire. Capteur de présence et de niveau maximal huile. 2 Pompe filtration huile à chaud max 180°C, nettoyage cuve, vidange cuve. 4 Élévateurs paniers intégrés. 2 Cuve 18 lt. cm.31x34x33h - 4 Paniers cm.13,5x29x21h. 2 Filtre, couvercle pour cuve. 2 Bassine de collecte de l'huile avec support sur roues et filtre 5 microns (pcs.100 inclus). Production de pommes frites: 54 kg/h (inclus 1 Élément de jonction top mod.TPA-7) • **ES** FREIDORA ELÉCTRICA ELECTRÓNICA CON PANTALLA TÁCTIL DE 7". CONSERVACIÓN A 110 °C O TRABAJO PREVIO A 160 °C CON O SIN FUSIÓN. SE PUEDEN ALMACENAR HASTA 100 PROGRAMAS EN LA MEMORIA. SENSOR DE PRESENCIA Y NIVEL MÁXIMO DE ACEITE. 2 BOMBA DE FILTRADO DE ACEITE CALIENTE, MÁXIMO 180 °C, LIMPIEZA DEL TANQUE, VACIADO DEL TANQUE. 4 ELEVADORES DE CESTA INTEGRADOS. 2 CUBAS DE 18 LITROS CM. 31X34X33H - 4 CESTAS CM.13,5X29X21H. 2 FILTROS Y TAPAS PARA CUBA. 2 CUBETAS DE RECOGIDA DE ACEITE CON SOPORTE SOBRE RUEDAS Y FILTRO DE 5 MICRONES (PZ.100 INCLUIDA). PROD. PATATAS: 54 KG/H (INCLUIDA 1 CHAPA DE CIERRE PARA TOP MOD.TPA-7)
 cm. 80x 70,5x 90h

BR50-78ETF/I BRASIERA a ribaltamento manuale, Vasca 50 litri cm.72x46,5x22h, fondo inox con coperchio
 08070835 **EN** Braising pan with manual tilting, bowl 50 lt. cm.72x46,5x22h, Stainless steel bottom with lid • **DE** Kippbratpfanne mit manual Kippung, 50 Lt. cm.72x46,5x22h, boden aus crnst. mit deckel • **FR** Sauteuse avec basculement manuel, cuve 50 lt. cm.72x46,5x22h, fond inox avec couvercle • **ES** SARTÉN CON LEVANTAMIENTO MANUAL, CUBA 50 LT. CM.72X46,5X22H, FONDO DE ACERO INOX CON TAPA
 cm. 80x 70,5x 90h



⚡ 10,5 kW **6.260,00**
 400V~3N 133 / 0,71
 50/60 Hz

BRM50-78ETF/I BRASIERA a ribaltamento automatico, Vasca 50 litri cm.72x46,5x22h, fondo inox con coperchio
 08070836 **EN** Braising pan with automatic tilting, bowl 50 lt. cm.72x46,5x22h, Stainless steel bottom with lid • **DE** Kippbratpfanne mit automatisch Kippung, 50 Lt. cm.72x46,5x22h, boden aus crnst. mit deckel • **FR** Sauteuse avec basculement automatique, cuve 50 lt. cm.72x46,5x22h, fond inox avec couvercle • **ES** SARTÉN CON LEVANTAMIENTO AUTOMÁTICO, CUBA 50 LT. CM.72X46,5X22H, FONDO DE ACERO INOX CON TAPA
 cm. 80x 70,5x 90h



⚡ 10,6 kW **7.861,00**
 400V~3N 135 / 0,71
 50 Hz

BRASIERE RIBALTABILI A GAS

MOD. _____
COD. _____

DESCRIZIONE/DESCRIPTION/BEZEICHNUNG/DESCRIPTION/DESCRIPCIÓN
DIMENSIONI/DIMENSIONS/ABMESSUNGEN/DIMENSIONS/DIMENSIONES

POTENZA/POWER/LEISTUNG/PUISSANCE/POTENCIA
VOLTAGGIO/VOLTAGE/SPANNUNG/VOLTAGE/VOLTAGE

⚡ $\frac{kW}{kcal/h}$ $\frac{V}{Hz}$

PREZZO/PRICE €
PREIS/PRIX/PRECIO
KG / M³

BR50-78GF/I BRASIERA a ribaltamento manuale, Vasca 50 litri cm.72x46,5x22h, fondo inox con coperchio
08240855

EN Braising pan with manual tilting, bowl 50 lt. cm.72x46,5x22h, Stainless steel bottom with lid • **DE** Kippbratpfanne mit manual Kippung, 50 Lt. cm.72x46,5x22h, boden aus crnst. mit deckel • **FR** Sauteuse avec basculement manuel, cuve 50 lt. cm.72x46,5x22h, fond inox avec couvercle • **ES SARTÉN CON LEVANTAMIENTO MANUAL, CUBA 50 LT. CM.72X46,5X22H, FONDO DE ACERO INOX CON TAPA**
cm. 80x 70,5x 90h



⚡ $\frac{14 kW}{12.040 kcal/h}$ **6.815,00**
135 / 0,71

BRM50-78GF/I BRASIERA a ribaltamento automatico, Vasca 50 litri cm.72x46,5x22h, fondo inox con coperchio
08240856

EN Braising pan with automatic tilting, bowl 50 lt. cm.72x46,5x22h, Stainless steel bottom with lid • **DE** Kippbratpfanne mit automatisch Kippung, 50 Lt. cm.72x46,5x22h, boden aus crnst. mit deckel • **FR** Sauteuse avec basculement automatique, cuve 50 lt. cm.72x46,5x22h, fond inox avec couvercle • **ES SARTÉN CON LEVANTAMIENTO AUTOMATICO, CUBA 50 LT. CM.72X46,5X22H, FONDO DE ACERO INOX CON TAPA**
cm. 80x 70,5x 90h



⚡ $\frac{14 kW}{12.040 kcal/h}$ **8.163,00**
139 / 0,71

⚡ $\frac{0,1 kW}{230V\sim}$
50 Hz

BRF-74ET BRASIERA FISSA MULTIFUNZIONALE ELETTRICA Vasca cm. 30x51x10h (inclusa 1 testata chiusura piano mod.TPA-7)
08070433

EN Electric multi-function fixed braising pan - Bowl cm. 30x51x10h (included 1 Head end filler strip mod.TPA-7) • **DE** Elektrische Multifunktionsbratpfanne Fest Becken cm. 30x51x10h (inbegriffen 1 Abschluss-Element mod.TPA-7) • **FR** Sauteuse fixe multifonction électrique - Cuve cm. 30x51x10h (inclus 1 Élément de jonction top mod.TPA-7) • **ES SARTEN FIJA MULTIFUNCIÓN ELÉCTRICA - CUBA CM. 30X51X10H (INCLUIDA 1 CHAPA DE CIERRE PARA TOP MOD. TPA-7)**
cm. 40x 70,5x 90h



⚡ $\frac{4 kW}{400V\sim 2N}$ **4.059,00**
 $\frac{230V\sim 3}{50/60 Hz}$ 79 / 0,37

BRF-78ET BRASIERA FISSA MULTIFUNZIONALE ELETTRICA Vasca cm. 70x51x10h (inclusa 1 testata chiusura piano mod.TPA-7)
08070833

EN Electric multi-function fixed braising pan - Bowl cm. 70x51x10h (included 1 Head end filler strip mod.TPA-7) • **DE** Elektrische Multifunktionsbratpfanne Fest Becken cm. 70x51x10h (inbegriffen 1 Abschluss-Element mod.TPA-7) • **FR** Sauteuse fixe multifonction électrique - Cuve cm. 70x51x10h (inclus 1 Élément de jonction top mod.TPA-7) • **ES SARTEN FIJA MULTIFUNCIÓN ELÉCTRICA - CUBA CM. 70X51X10H (INCLUIDA 1 CHAPA DE CIERRE PARA TOP MOD. TPA-7)**
cm. 80x 70,5x 90h



⚡ $\frac{8 kW}{400V\sim 3N}$ **6.139,00**
 $\frac{50/60 Hz}{126 / 0,71}$

BRF-74G BRASIERA FISSA MULTIFUNZIONALE GAS Vasca 30x51x10h (inclusa 1 testata chiusura piano mod.TPA-7)
08240453

EN Gas multi-function fixed braising pan Bowl 30x51x10h (included 1 Head end filler strip mod.TPA-7) • **DE** Gas-Multifunktionsbratpfanne Fest Becken 30x51x10h (inbegriffen 1 Abschluss-Element mod.TPA-7) • **FR** Sauteuse fixe multifonction à gaz - Cuve 30x51x10h (inclus 1 Élément de jonction top mod.TPA-7) • **ES SARTEN FIJA MULTIFUNCIÓN A GAS - CUBA 30X51X10H (INCLUIDA 1 CHAPA DE CIERRE PARA TOP MOD.TPA-7)**
cm. 40x 70,5x 90h



⚡ $\frac{6,95 kW}{5.970 kcal/h}$ **4.257,00**
79 / 0,37

BRF-78G BRASIERA FISSA MULTIFUNZIONALE GAS Vasca 70x51x10h (inclusa 1 testata chiusura piano mod.TPA-7)
08240853

EN Gas multi-function fixed braising pan Bowl 70x51x10h (included 1 Head end filler strip mod.TPA-7) • **DE** Gas-Multifunktionsbratpfanne Fest Becken 70x51x10h (inbegriffen 1 Abschluss-Element mod.TPA-7) • **FR** Sauteuse fixe multifonction à gaz - Cuve 70x51x10h (inclus 1 Élément de jonction top mod.TPA-7) • **ES SARTEN FIJA MULTIFUNCIÓN A GAS - CUBA 70X51X10H (INCLUIDA 1 CHAPA DE CIERRE PARA TOP MOD.TPA-7)**
cm. 80x 70,5x 90h



⚡ $\frac{13,9 kW}{11.940 kcal/h}$ **6.555,00**
129 / 0,71

PIANI LAVORO

MOD. _____ DESCRIZIONE/DESCRIPTION/BEZEICHNUNG/DESCRIPTION/DESCRIPCIÓN POTENZA/POWER/LEISTUNG/PUISSANCE/POTENCIA kW kcal/h kw V~ Hz PREZZO/PRICE € PREIS/PRIX/PRECIO € KG / M³
 COD. _____ DIMENSIONI/DIMENSIONS/ABMESSUNGEN/DIMENSIONS/DIMENSIONES VOLTAGGIO/VOLTAGE/SPANNUNG/VOLTAGE/VOLTAJE

PL-72 PIANO LAVORO SU MOBILE (inclusa 1 testata chiusura piano mod.TPA-7) **778,00**
 08010200 **EN** Worktop on cabinet (included 1 Head end filler strip mod.TPA-7) **30 / 0,37**
 • **DE** Arbeitsplatte mit Unterbau (inbegriffen 1 Abschluss-Element mod. TPA-7) • **FR** Plan de travail sur armoire (inclus 1 Élément de jonction top mod.TPA-7) • **ES SOBRE DE TRABAJO SOBRE MUEBLE (INCLUIDA 1 CHAPA DE CIERRE PARA TOP MOD.TPA-7)**
cm. 20x 70,5x 90h



PLS-73 PIANO LAVORO SU MOBILE A GIORNO (inclusa 1 testata chiusura piano mod.TPA-7) **939,00**
 08010301 **EN** Worktop on open cabinet (included 1 Head end filler strip mod.TPA-7) **35 / 0,37**
 • **DE** Arbeitsplatte mit offenem Unterbau (inbegriffen 1 Abschluss-Element mod.TPA-7) • **FR** Plan de travail sur armoire ouvert (inclus 1 Élément de jonction top mod.TPA-7) • **ES SOBRE DE TRABAJO SOBRE MUEBLE ABIERTO (INCLUIDA 1 CHAPA DE CIERRE PARA TOP MOD.TPA-7)**
cm. 30x 70,5x 90h



PLS-74 **cm. 40x 70,5x 90h** **968,00**
 08010401 **40 / 0,37**



PLS-76 **cm. 60x 70,5x 90h** **1.461,00**
 08010601 **47 / 0,54**



PLS-78 **cm. 80x 70,5x 90h** **1.634,00**
 08010801 **55 / 0,71**



PL-73 PIANO LAVORO SU MOBILE A GIORNO Cassetto - 1 bacinella inox cm 19x50x15h (inclusa 1 testata chiusura piano mod.TPA-7) **1.274,00**
 08010300 **EN** Worktop on open cabinet Drawer - 1 inox container cm 19x50x15h (included 1 Head end filler strip mod.TPA-7) • **DE** Arbeitsplatte mit offenem Unterbau Schublade - 1 Chromnickelstahlbehälter cm 19x50x15h (inbegriffen 1 Abschluss-Element mod.TPA-7) • **FR** Plan de travail sur armoire ouvert Tiroir - Bac en inox cm 19x50x15h (inclus 1 Élément de jonction top mod.TPA-7) • **ES SOBRE DE TRABAJO SOBRE MUEBLE ABIERTO CAJÓN - 1 CONTENEDOR CM 19X50X15H DE ACERO INOX (INCLUIDA 1 CHAPA DE CIERRE PARA TOP MOD.TPA-7)**
cm. 30x 70,5x 90h



PIANI LAVORO

MOD. COD. DESCRIZIONE/DESCRIPTION/BEZEICHNUNG/DESCRIPTION/DESCRIPCIÓN DIMENSIONI/DIMENSIONS/ABMESSUNGEN/DIMENSIONS/DIMENSIONES POTENZA/POWER/LEISTUNG/PUISSANCE/POTENCIA VOLTAGGIO/VOLTAGE/SPANNUNG/VOLTAGE/VOLTAJE kW kcal/h kw V~ Hz PREZZO/PRICE € PREIS/PRIX/PRECIO € KG / M³

PL-74
08010400

PIANO LAVORO SU MOBILE A GIORNO Cassetto con 1 bacinella GN 1/1 15h plastica (inclusa 1 testata chiusura piano mod.TPA-7)
EN Worktop on open cabinet Drawer with 1 plastic container GN 1/1 15h (included 1 Head end filler strip mod.TPA-7) • **DE** Arbeitsplatte mit offenem Unterbau Schublade mit 1 GN 1/1 15h Kunststoffbehälter (inbegriffen 1 Abschluss-Element mod.TPA-7) • **FR** Plan de travail sur armoire ouvert Tiroir avec bac en plastique GN 1/1 15h. (inclus 1 Élément de jonction top mod.TPA-7) • **ES SOBRE DE TRABAJO SOBRE MUEBLE ABIERTO CAJÓN CON 1 CONTENEDOR GN 1/1 15H PLÁSTICO (INCLUIDA 1 CHAPA DE CIERRE PARA TOP MOD. TPA-7)**
cm. 40x 70,5x 90h



1.228,00
45 / 0,37

PL-76
08010600

PIANO LAVORO SU MOBILE A GIORNO Cassetto - 1 bacinella inox cm 49x50x15h (inclusa 1 testata chiusura piano mod.TPA-7)
EN Worktop on open cabinet Drawer - 1 inox container cm 49x50x15h (included 1 Head end filler strip mod.TPA-7) • **DE** Arbeitsplatte mit offenem Unterbau Schublade - 1 Chromnickelstahlbehälter cm 49x50x15h (inbegriffen 1 Abschluss-Element mod.TPA-7) • **FR** Plan de travail sur armoire ouvert Tiroir - Bac en inox cm 49x50x15h (inclus 1 Élément de jonction top mod.TPA-7) • **ES SOBRE DE TRABAJO SOBRE MUEBLE ABIERTO CAJÓN - 1 CONTENEDOR CM 49X50X15H DE ACERO INOX (INCLUIDA 1 CHAPA DE CIERRE PARA TOP MOD.TPA-7)**
cm. 60x 70,5x 90h



1.751,00
56 / 0,54

PL-78
08010800

PIANO LAVORO SU MOBILE A GIORNO Cassetto con 2 bacinelle GN 1/1 15h plastica (inclusa 1 testata chiusura piano mod.TPA-7)
EN Worktop on open cabinet Drawer with 2 plastic containers GN 1/1 15h (included 1 Head end filler strip mod.TPA-7) • **DE** Arbeitsplatte mit offenem Unterbau Schublade mit 2 GN 1/1 15h Kunststoffbehälter (inbegriffen 1 Abschluss-Element mod.TPA-7) • **FR** Plan de travail sur armoire ouvert Tiroir avec 2 bacs en plastique GN 1/1 15h (inclus 1 Élément de jonction top mod.TPA-7) • **ES SOBRE DE TRABAJO SOBRE MUEBLE ABIERTO CAJÓN CON 2 CONTENEDORES GN 1/1 15H PLÁSTICO (INCLUIDA 1 CHAPA DE CIERRE PARA TOP MOD.TPA-7)**
cm. 80x 70,5x 90h



1.954,00
67 / 0,71

LA-74
08020400

LAVELLO SU MOBILE A GIORNO Rubinetto a leva - Vasca cm. 30x35x15h (inclusa 1 testata chiusura piano mod.TPA-7)
EN Sink unit on open cabinet - Lever type tap. Bowl cm. 30x35x15h (included 1 Head end filler strip mod.TPA-7) • **DE** Spülbecken Einhebel-Mischbatterie mit offenem Unterbau - Becken cm. 30x35x15h (inbegriffen 1 Abschluss-Element mod.TPA-7) • **FR** Bac-évier sur armoire ouvert avec robinetterie - Bac cm. 30x35x15h (inclus 1 Élément de jonction top mod.TPA-7) • **ES FREGADERO SOBRE MUEBLE ABIERTO - GRIFO A PALANCA - PILETA CM. 30X35X15H (INCLUIDA 1 CHAPA DE CIERRE PARA TOP MOD.TPA-7)**
cm. 40x 70,5x 90h



1.565,00
45 / 0,37

P-73/93-DX
08430300

PORTA 300 DESTRA
EN Right door 300 • **DE** Rechte tür 300 • **FR** Porte droite 300 • **ES PUERTA DERECHA 300**
cm. 29,5x 2,5x 47,5h



213,00
3 / 0,01

P-74/94-DX
08430400

PORTA 400 DESTRA
EN Right door 400 • **DE** Rechte tür 400 • **FR** Porte droite 400 • **ES PUERTA DERECHA 400**
cm. 39,5x 2,5x 47,5h

220,00
3.5 / 0,02

ACCESSORI

MOD. _____ DESCRIZIONE/DESCRIPTION/BEZEICHNUNG/DESCRIPTION/DESCRIPCIÓN POTENZA/POWER/LEISTUNG/PUISSANCE/POTENCIA kW kcal/h $\frac{kW}{Hz}$ PREZZO/PRICE €
 COD. _____ DIMENSIONI/DIMENSIONS/ABMESSUNGEN/DIMENSIONS/DIMENSIONES VOLTAGGIO/VOLTAGE/SPANNUNG/VOLTAGE/VOLTAJE $\frac{V}{Hz}$ PREIS/PRIX/PRECIO €
 KG / M³

P-73/93-SX PORTA 300 SINISTRA
 08430301 **EN** Left door 300 • **DE** Linke tür 300 • **FR** Porte gauche 300 • **ES**
PUERTA IZQUIERDA 300
cm. 29,5x 2,5x 47,5h



213,00
 3 / 0,01

P-74/94-SX PORTA 400 SINISTRA
 08430401 **EN** Left door 400 • **DE** Linke tür 400 • **FR** Porte gauche 400 • **ES**
PUERTA IZQUIERDA 400
cm. 39,5x 2,5x 47,5h

220,00
 3.5 / 0,02

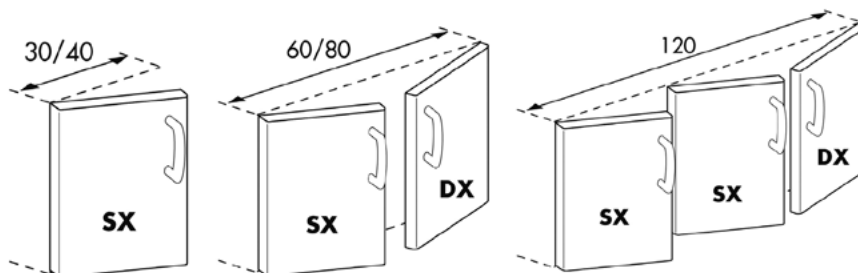

C-73/93 CASSETTIERA 300 N. 2 cassetti con 2 bacinelle inox, guide telescopiche.
 Solo su PL
 08440320 **EN** Drawer set 300 N. 2 drawers with 2 inox containers, telescopic guides. Only for PL • **DE** Schubladen 300 - N. 2 Schubladen mit 2 Chromnickelstahlbehältern, Telescopeinführungen. Nur für PL • **FR** Tiroirs pour meuble de 300 N. 2 tiroirs avec 2 bacs inox, guides télescopiques. Seulement pour PL • **ES CAJONERA 300 - N. 2 CAJONES CON 2 CONTENEDORES DE ACERO INOX, GUÍAS TELESCÓPICAS. SOLO PARA PL**
cm. 29,5x 59x 47,5h



827,00
 16 / 0,19

C-74/94 CASSETTIERA 400 - N. 2 cassetti con 2 bacinelle GN 1/1 15h in plastica, guide telescopiche. Solo su PL
 08440420 **EN** Drawer set 400 - N. 2 drawers with 2 GN 1/1 15h plastic containers, telescopic guides. Only for PL • **DE** Schubladen - N. 2 Schubladen mit 2 GN 1/1 15h Kunststoffbehältern, Telescopeinführungen. Nur für PL • **FR** Tiroirs pour meuble de 400 - N. 2 tiroirs avec 2 bacs en plastique GN 1/1 15h, guides télescopiques. Seulement pour PL • **ES CAJONERA 400 - N. 2 CAJONES CON 2 CONTENEDORES GN 1/1 15H DE PLÁSTICO, GUÍAS TELESCÓPICAS. SOLO PARA PL**
cm. 39,5x 59x 47,5h



849,00
 18 / 0,19

C-76/96 CASSETTIERA 600 N. 2 cassetti con 2 bacinelle inox, guide telescopiche.
 Solo su PL
 08440620 **EN** Drawer set 600 N. 2 drawers with 2 inox containers, telescopic guides. Only for PL • **DE** Schubladen 600 - N. 2 Schubladen mit 2 Chromnickelstahlbehältern, Telescopeinführungen. Nur für PL • **FR** Tiroirs pour meuble de 600 N. 2 tiroirs avec 2 bacs inox, guides télescopiques. Seulement pour PL • **ES CAJONERA 600 - N. 2 CAJONES CON 2 CONTENEDORES DE ACERO INOX, GUÍAS TELESCÓPICAS. SOLO PARA PL**
cm. 59,5x 59x 47,5h



1.173,00
 22 / 0,28

C-78/98 CASSETTIERA 800 - N. 2 cassetti con 4 bacinelle GN 1/1 15h in plastica, guide telescopiche. Solo su PL
 08440820 **EN** Drawer set 800 - N. 2 drawers with 4 GN 1/1 15h plastic containers, telescopic guides. Only for PL • **DE** Schubladen 800 - N. 2 Schubladen mit 4 GN 1/1 15h Kunststoffbehältern, Telescopeinführungen. Nur für PL • **FR** Tiroirs pour meuble de 800 - N. 2 tiroirs avec 4 bacs en plastique GN 1/1 15h, guides télescopiques. Seulement pour PL • **ES CAJONERA 800 - N. 2 CAJONES CON 4 CONTENEDORES GN 1/1 15H DE PLÁSTICO, GUÍAS TELESCÓPICAS. SOLO PARA PL**
cm. 79,5x 59x 47,5h



1.193,00
 26 / 0,37

ACCESSORI

MOD. _____ DESCRIZIONE/DESCRIPTION/BEZEICHNUNG/DESCRIPTION/DESCRIPCIÓN POTENZA/POWER/LEISTUNG/PUISSANCE/POTENCIA ⚡kW ⚡kw PREZZO/PRICE €
 COD. _____ DIMENSIONI/DIMENSIONS/ABMESSUNGEN/DIMENSIONS/DIMENSIONES VOLTAGGIO/VOLTAGE/SPANNUNG/VOLTAGE/VOLTAJE kcal/h kcal/h V~ V~ PREIS/PRIX/PRECIO €
 KG / M³

SIA-7/9 STAFFA INFERIORE UNIONE APPARECCHI **64,00**
 08480000 **EN** Lower bracket to join two items **2 / 0,00**

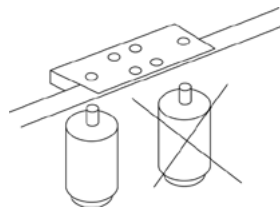

SR-100 SET 4 RUOTE Ø 100x30, 2 con freno **383,00**
 50900001 **EN** Set of 4 wheels Ø 100x30, 2 with brake • **DE** 4 Rollen Satz Ø 100x30, 2 davon mit Feststellbremse • **FR** Kit 4 roues Ø 100x30, 2 avec frein • **ES EQUIPO 4 RUEDAS Ø 100X30, 2 CON FRENOS cm. 12,7h** **1 / 0,01**

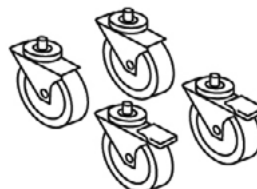

D-7 DIVISORIO **172,00**
 08470000 **EN** Spacer • **DE** Trennwand • **FR** Separation • **ES DIVISORIO cm. 5x 59x 45h** **2.5 / 0,02**

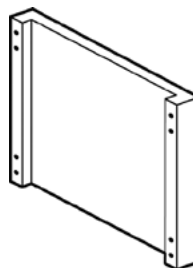

R-74 RIPIANO 400 SOLO PL **136,00**
 08450400 **EN** Shelf 400 Only for PL • **DE** Zwischenboden 400 Nur für PL • **FR** Étagère 400 Seulement pour PL • **ES ESTANTE 400 SOLO PARA PL cm. 35x 59x 2h** **2 / 0,01**

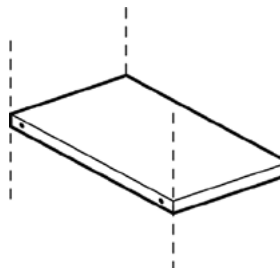

R-76 RIPIANO 600 SOLO PL **154,00**
 08450600 **EN** Shelf 600 Only for PL • **DE** Zwischenboden 600 Nur für PL • **FR** Étagère 600 Seulement pour PL • **ES ESTANTE 600 SOLO PARA PL cm. 55x 59x 2h** **3 / 0,01**

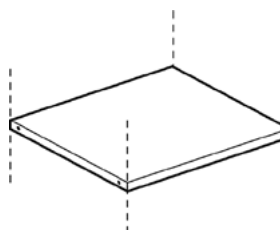

R-78 RIPIANO 800 SOLO PL **172,00**
 08450800 **EN** Shelf 800 Only for PL • **DE** Zwischenboden 800 Nur für PL • **FR** Étagère 800 Seulement pour PL • **ES ESTANTE 800 SOLO PARA PL cm. 75x 59x 2h** **3.5 / 0,02**

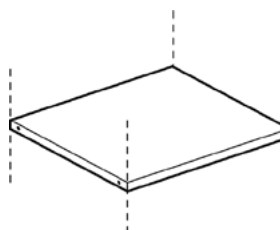

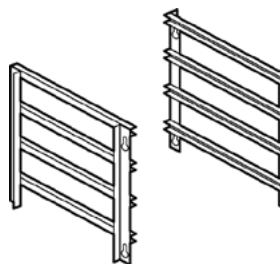

PT-74/94 PORTATEGLIE VANO 400/600 (GN-1/1) 4 ripiani int. 7 cm. **459,00**
 08460002 **EN** Frame for plates 400/600 (GN-1/1) - N. 4 shelves, wheel-base 7 cm. • **DE** Aufhängeschienen für bleche 400/600 (GN-1/1) N. 4 Etagen, Abstand 7 cm. • **FR** Kit porte-plaques 400/600 (GN-1/1) - N. 4 étagères; 7 cm. • **ES PORTACAZUELAS 400/600 (GN-1/1) - N. 4 ESTANTES, INT. 7 CM.** **2.5 / 0,01**



PT-78/98 PORTATEGLIE VANO 800 (GN-2/1) 4 ripiani int. 7 cm. **613,00**
 08460012 **EN** Frame for plates 800 (GN-2/1) 4 Etagen, Abstand 7 cm. • **DE** Aufhängeschienen für bleche 800 (GN-2/1) N. 4 Etagen, Abstand 7 cm. • **FR** Kit porte-plaques 800 (GN-2/1) - N. 4 étagères; 7 cm. • **ES PORTACAZUELAS 800 (GN-2/1) - N. 4 ESTANTES, INT. 7 CM.** **4 / 0,01**



ACCESSORI BRASIERE

MOD. COD.	DESCRIZIONE/DESCRIPTION/BEZEICHNUNG/DESCRIPTION/DESCRIPCIÓN DIMENSIONI/DIMENSIONS/ABMESSUNGEN/DIMENSIONS/DIMENSIONES	POTENZA/POWER/LEISTUNG/PUISSANCE/POTENCIA VOLTAGGIO/VOLTAGE/SPANNUNG/VOLTAGE/VOLTAJE	⚡ kW kcal/h	⚡ kw V~ Hz	PREZZO/PRICE PREIS/PRIX/PRECIO € KG / M ³
08550400	COPERCHIO BRF-74 EN Lid BRF-74 • DE Deckel BRF-74 • FR Couvercle BRF-74 • ES TAPA BRF-74 cm. 32x 53x 5h				154,00 2 / 0,02
08550800	COPERCHIO BRF-78 EN Lid BRF-78 • DE Deckel BRF-78 • FR Couvercle BRF-78 • ES TAPA BRF-78 cm. 72x 53x 5h				205,00 4 / 0,03
TG-4 07580400	TAGLIERE PLASTICA EN Plastic chopping-board • DE Schneidebrett • FR Plan de decoupe • ES PICADOR DE PLÁSTICO cm. 39x 58x 2,5h				170,00 6 / 0,01
TG-6 07580600	cm. 59x 58x 2,5h				251,00 9 / 0,02
TG-8 07580800	cm. 79x 58x 2,5h				324,00 11 / 0,02
CBTEST	"CB TEST CERTIFICATE" per apparecchi: FT**-74/78/712ET**, PC/PCT/ PCQ/PCQT-74/78/712ET, CF4/CFQ4-78ET, CF6/CQ6-712ET/ETV, F13/18-74ET, F2/13-78ET, F2/18-78ET, TP/TPT-78ET EN "CB TEST CERTIFICATE" for model: FT**-74/78/712ET**, PC/ PCT/PCQ/PCQT-74/78/712ET, CF4/CFQ4-78ET, CF6/CQ6-712ET/ ETV, F13/18-74ET, F2/13-78ET, F2/18-78ET, TP/TPT-78ET • DE "CB TEST CERTIFICATE" für modell: FT**-74/78/712ET**, PC/PCT/ PCQ/PCQT-74/78/712ET, CF4/CFQ4-78ET, CF6/CQ6-712ET/ETV, F13/18-74ET, F2/13-78ET, F2/18-78ET, TP/TPT-78ET • FR "CB TEST CERTIFICATE" pour modèle: FT**-74/78/712ET**, PC/PCT/PCQ/PCQT- 74/78/712ET, CF4/CFQ4-78ET, CF6/CQ6-712ET/ETV, F13/18-74ET, F2/13-78ET, F2/18-78ET, TP/TPT-78ET • ES "CB TEST CERTIFICATE" PARA MODELO: FT**-74/78/712ET**, PC/PCT/PCQ/ PCQT-74/78/712ET, CF4/CFQ4-78ET, CF6/CQ6-712ET/ETV, F13/18-74ET, F2/13-78ET, F2/18-78ET, TP/TPT-78ET				201,00 /
OPT-GA	ACCENSIONE ELETTRICA per apparecchi gas: PC-74GA, PC-78GA, PC- 712GA, PC-716GA, PCT-74GA, PCT-78GA, PCT-712GA, PCT-716GA, CF6-712GAV, CF6-712GA, CF4-78GA - CF4-78GAE, CF6-712GAEV, CF6-712GAE, CFV4-78GAE, CFV6-712GAEV (prezzo a bruciatore) EN electric ignition for gas model: PC-74GA, PC-78GA, PC-712GA, PC-716GA, PCT-74GA, PCT-78GA, PCT-712GA, PCT-716GA, CF6- 712GAV, CF6-712GA, CF4-78GA - CF4-78GAE, CF6-712GAEV, CF6-712GAE, CFV4-78GAE, CFV6-712GAEV (PRICE FOR 1 BURNER) • DE elektrische Zündung für gas modell: PC-74GA, PC-78GA, PC- 712GA, PC-716GA, PCT-74GA, PCT-78GA, PCT-712GA, PCT-716GA, CF6-712GAV, CF6-712GA, CF4-78GA - CF4-78GAE, CF6-712GAEV, CF6-712GAE, CFV4-78GAE, CFV6-712GAEV (PREIS FÜR 1 BRENNER) • FR allumage électrique pour modèle a gaz: PC-74GA, PC-78GA, PC- 712GA, PC-716GA, PCT-74GA, PCT-78GA, PCT-712GA, PCT-716GA, CF6-712GAV, CF6-712GA, CF4-78GA - CF4-78GAE, CF6-712GAEV, CF6-712GAE, CFV4-78GAE, CFV6-712GAEV (PRIX POUR 1 BRÛLEUR) • ES IGNICIÓN ELÉCTRICA PARA MODELO GAS: PC-74GA, PC-78GA, PC-712GA, PC-716GA, PCT-74GA, PCT-78GA, PCT- 712GA, PCT-716GA, CF6-712GAV, CF6-712GA, CF4-78GA - CF4-78GAE, CF6-712GAEV, CF6-712GAE, CFV4-78GAE, CFV6-712GAEV (PRECIO POR 1 QUEMADOR)		⚡ 0,01 KW 230V~ 50/60 Hz		270,00 /
532005901	GRIGLIA 1 FUOCO EN 1 flame grill • DE Rost 1 flamme • FR Frille 1 feu • ES PARILLA 1 QUEMADOR				116,00 3 / 0,01

ACCESSORI

MOD. _____ DESCRIZIONE/DESCRIPTION/BEZEICHNUNG/DESCRIPTION/DESCRIPCIÓN POTENZA/POWER/LEISTUNG/PUISSANCE/POTENCIA ⚡kW ⚡kw PREZZO/PRICE €
 COD. _____ DIMENSIONI/DIMENSIONS/ABMESSUNGEN/DIMENSIONS/DIMENSIONES VOLTAGGIO/VOLTAGE/SPANNUNG/VOLTAGE/VOLTAJE kcal/h V~ Hz PREIS/PRIX/PRECIO €
 KG / M³

544439900 ANELLO PER WOK - solo per griglie in ghisa
EN Wok ring - only for cast iron grills • **DE** Wok Aufsatzring - nur für Roste aus Gusseisen • **FR** Anneau Wok - seulement pour grilles en fonte • **ES ANILLO WOK - SOLO PARA PARRILAS DE HIERRO COLADO**
cm. Ø22,5x 3,5h



170,00
2 / 0,00

KIT-WOK
09580040 KIT WOK - fiamma verticale - solo su bruciatore da 10 KW e griglie in ghisa
EN KIT WOK - vertical flame - only for 10 kW burner and cast iron grills
 • **DE** KIT WOK - vertikaler Flamme - nur 10 kW-Brenner und Roste aus Gusseisen • **FR** KIT WOK - verticale de la flamme - seulement 10 kW brûleur et grilles en fonte • **ES KIT WOK - LLAMA VERTICAL - SÓLO 10 KW QUEMADOR Y PARRILAS DE HIERRO COLADO**
cm. Ø 26x 16h



456,00
5 / 0,02

PLF
07590401 PIASTRA LISCIA per GRIGLIA IN GHISA
EN Smooth griddle plate for cast iron grid • **DE** Fortkochplatte glatt für Gusseisen Rost • **FR** Plaque lisse pour la grille en fonte • **ES PLANCHA LISA PARA REJILLA DE HIERRO FUNDIDO**
cm. 35x 27



205,00
9 / 0,01

PLF/2
07590421 PIASTRA LISCIA 2 FUOCHI per GRIGLIA IN GHISA
EN Smooth griddle plate 2 burners for cast iron grid • **DE** Fortkochplatte glatt 2 Kochstellen für Gusseisen Rost • **FR** Plaque lisse 2 feux pour la grille en fonte • **ES PLANCHA LISA 2 QUEMADORES PARA REJILLA DE HIERRO FUNDIDO**
cm. 35x 57

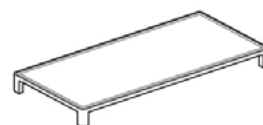

405,00
18 / 0,01

PRF
07590403 PIASTRA RIGATA per GRIGLIA IN GHISA
EN Grooved griddle plate for cast iron grid • **DE** Fortkochplatte gerillt für Gusseisen Rost • **FR** Plaque nervurée pour la grille en fonte • **ES PLANCHA ESTRIADA PARA REJILLA DE HIERRO FUNDIDO**
cm. 35x 27

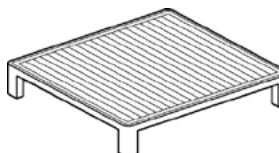

274,00
9 / 0,01

PRF/2
07590423 PIASTRA RIGATA 2 FUOCHI per GRIGLIA IN GHISA
EN Grooved griddle plate 2 burners for cast iron grid • **DE** Fortkochplatte gerillt 2 Kochstellen für Gusseisen Rost • **FR** Plaque nervurée 2 feux pour la grille en fonte • **ES PLANCHA ESTRIADA 2 QUEMADORES PARA REJILLA DE HIERRO FUNDIDO**
cm. 35x 57



450,00
18 / 0,01

PLFT/7
08590451 PIASTRA LISCIA per GRIGLIA IN TONDINO
EN Smooth griddle plate for grid rod • **DE** Fortkochplatte glatt für Gitterstab • **FR** Plaque lisse pour tige grille • **ES PLANCHA LISA POR RED DE VARILLA**
cm. 35x 27



205,00
9 / 0,01

PLFT/72
08590471 PIASTRA LISCIA 2 FUOCHI per GRIGLIA IN TONDINO
EN Smooth griddle plate 2 burners for grid rod • **DE** Fortkochplatte glatt 2 Kochstellen für Gitterstab • **FR** Plaque lisse 2 feux pour tige grille • **ES PLANCHA LISA 2 QUEMADORES POR RED DE VARILLA**
cm. 35x 57

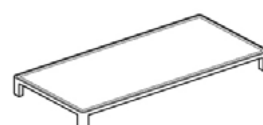

405,00
18 / 0,01

PRFT/7
08590453 PIASTRA RIGATA per GRIGLIA IN TONDINO
EN Grooved griddle plate for grid rod • **DE** Fortkochplatte gerillt für Gitterstab • **FR** Plaque nervurée pour tige grille • **ES PLANCHA ESTRIADA POR RED DE VARILLA**
cm. 35x 27

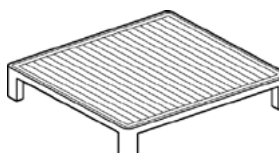

274,00
9 / 0,01



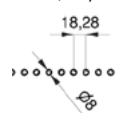

ACCESSORI

MOD. COD.	DESCRIZIONE/DESCRIPTION/BEZEICHNUNG/DESCRIPTION/DESCRIPCIÓN DIMENSIONI/DIMENSIONS/ABMESSUNGEN/DIMENSIONS/DIMENSIONES	POTENZA/POWER/LEISTUNG/PUISSANCE/POTENCIA VOLTAGGIO/VOLTAGE/SPANNUNG/VOLTAGE/VOLTAJE	⚡ kW kcal/h	⚡ kW V~ Hz	PREZZO/PRICE € PREIS/PRIX/PRECIO € KG / M³
PRFT/72 08590473	PIASTRA RIGATA 2 FUOCHI per GRIGLIA IN TONDINO EN Grooved griddle plate 2 burners for grid rod • DE Fortkochplatte gerillt 2 Kochstellen für Gitterstab • FR Plaque nervurée 2 feux pour tige grille • ES PLANCHA ESTRIADA 2 QUEMADORES POR RED DE VARILLA cm. 35x 57				450,00 18 / 0,01
533009200	GRIGLIA DI RIDUZIONE EN Reduction • DE Reduzierstern • FR Grille de réduction • ES REJILLA DE REDUCCIÓN cm. 25x 25				43,00 0.2 / 0,00
RV 08660410	RISCALDANTE VANO CUCINA EN Heater for range's cabinet • DE Heizer für Herden-Schränkelement • FR Réchauffeur pour armoire du fourneau • ES CALEFACCIÓN PARA ARMARIO NEUTRO DE LA COCINA cm. 32x 48,5x 8h			⚡ 0,75 kW 230V~ 50/60 Hz	975,00 8 / 0,08
RCRV-74 08450402	RIPIANO FORATO IN APPOGGIO PER RISCALDANTE SU VANO CUCINA EN Perforated shelf for heater element mod.RV for cooker cabinet • DE regale Gelocht für Heizer mod.RV für Herden-Schränkelement • FR Étagère perforées pour réchauffeur mod.RV pour armoire du fourneau • ES ESTANTE PERFORADO PARA ELEMENTO DE CALEFACCION MOD.RV PARA ARMARIO NEUTRO DE LA COCINA cm. 34x 55x 10h				379,00 5 / 0,03
RRV-74 08450401	RIPIANO FORATO IN APPOGGIO PER RISCALDANTE EN Perforated shelf for heater element mod.RV • DE regale Gelocht für Heizer mod.RV • FR Étagère perforées pour réchauffeur mod.RV • ES ESTANTE PERFORADO PARA ELEMENTO DE CALEFACCION MOD.RV cm. 34x 57x 10h				379,00 5 / 0,03
RRV-76 08450601	cm. 54x 57x 10h				582,00 7 / 0,04
RRV-78 08450801	cm. 74x 57x 10h				836,00 9 / 0,06
RRV-710 08451001	cm. 94x 57x 10h				1.048,00 11 / 0,08
RRV-712 08451201	cm. 114x 57x 10h				1.341,00 14 / 0,09
RRV-716 08451601	cm. 154x 57x 10h				1.707,00 18 / 0,12
08570401	GRIGLIA TONDINO per CW (SERIE 70) EN Grid for CW (70 line) • DE Gitter für CW (70. Serie) • FR Grille ronde pour CW (serie 70) • ES REJILLA PARA CW (SERIE 70) cm. 36x 51x				455,00 11 / 0,03

Línea 70

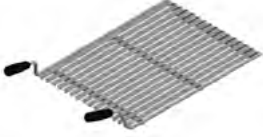
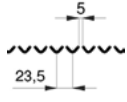

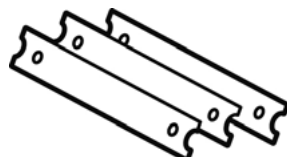
ACCESSORI GRIGLIE

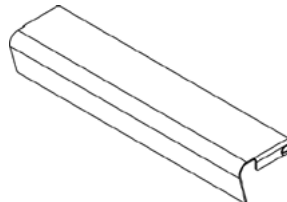
MOD. COD.	DESCRIZIONE/DESCRIPTION/BEZEICHNUNG/DESCRIPTION/DESCRIPCIÓN DIMENSIONI/DIMENSIONS/ABMESSUNGEN/DIMENSIONS/DIMENSIONES	POTENZA/POWER/LEISTUNG/PUISSANCE/POTENCIA VOLTAGGIO/VOLTAGE/SPANNUNG/VOLTAGE/VOLTAJE	⚡ kcal/h kw V~ Hz	PREZZO/PRICE PREIS/PRIX/PRECIO € KG / M ²
08570402	GRIGLIA TEGOLO V per CW (SERIE 70) EN Grid V for CW (70 line) • DE Gitter V für CW (70. Serie) • FR Grille V pour CW (serie 70) • ES REJILLA V PARA CW (SERIE 70) cm. 36x 51x			455,00 11 / 0,03
				
544023800	RASCHIETTO PER PIASTRA RIGATA EN Scraper for grooved plate • DE Schaber für gerillte Kochplatte • FR Racloir pour plaque nervurée • ES RASQUETA PARA PLACA RANURADA			69,00 / 1,00
				
531040800	RASCHIETTO PER PIASTRA LISCIA AL CROMO LUCIDO EN Scraper for smooth POLISHED CHROME plate • DE Schaber für glatte POLIERTEM CHROM Platte • FR Racloir pour plaque lisse au CHROME POLI • ES RASQUETA PARA PLACA LISA DE CROMO PULIDO			63,00 / 1,00
				
531040900	KIT 10 LAME PER RASCHIETTO cod.531040800 EN 10 blades kit for scraper cod.531040800 • DE Kit 10 klingen für Schaber cod.531040800 • FR Kit de 10 lames pour racloir cod.531040800 • ES KIT DE 10 CUCHILLAS PARA RASQUETA COD.531040800			45,00 / 0,00
				
T-FT 09580060	TAPPO PER FRY-TOP EN stopper for Fry-top • DE Stopfen griddleplatte • FR bouchon pour Plaque • ES TAPÓN FRY-TOP cm. 10x 2x 5h			268,00 / 0,00
				
PFT-74 08620400	KIT PROTEZIONE FRONTALE PIANO FRY-TOP EN KIT front protection plan fry-top • DE Schutz-kit vorne Plan griddleplatte • FR KIT protection avant plan plaque • ES KIT DE PROTECCIÓN FRONTAL PLAN DE FRY-TOP cm. 35x 8x 6h			137,00 / 0,00
				
PFT-76 08620600	cm. 55x 8x 6h			186,00 / 0,01
PFT-78 08620800	cm. 75x 8x 6h			233,00 / 0,01
PFT-712 08621200	cm. 115x 8x 6h			265,00 / 0,01

ACCESSORI FRIGGITRICI

MOD. COD.	DESCRIZIONE/DESCRIPTION/BEZEICHNUNG/DESCRIPTION/DESCRIPCIÓN DIMENSIONI/DIMENSIONS/ABMESSUNGEN/DIMENSIONS/DIMENSIONES	POTENZA/POWER/LEISTUNG/PUISSANCE/POTENCIA VOLTAGGIO/VOLTAGE/SPANNUNG/VOLTAGE/VOLTAJE	$\frac{kW}{kcal/h}$ $\frac{kw}{V\sim}$ Hz	PREZZO/PRICE € KG / M ³
KF-F-ETD S70 546003402	KIT 100 filtri 5 micron per F-ETDP S70 EN KIT 100 sieve 5 microns for F-ETDP S70 • DE KIT 100 Filter 5-Mikron für F-ETDP S70 • FR KIT 100 filtre 5 microns pour F-ETDP S70 • ES KIT 100 FILTRO DE 5 MICRONES PARA F-ETDP S70			433,00 0.1 / 0,00
531013200	CESTINO 1/2 per F13-G/E EN Basket 1/2 for F13-G/E • DE Korb 1/2 für F13-G/E • FR Panier 1/2 pour F13-G/E • ES CESTA 1/2 PARA F13-G/E cm. 10x 30x 12h			63,00 0.7 / 0,03
531013500	CESTINO 1/2 per F18-70G EN Basket 1/2 for F18-70G • DE Korb 1/2 für F18-70G • FR Panier 1/2 pour F18-70G • ES CESTA 1/2 PARA F18-70G cm. 14x 33x 12h			77,00 0.8 / 0,04
531041600	CESTINO 1/2 per F18-E (standard in F18-ETD) EN Basket 1/2 for F18-E (standard F18-ETD) • DE Korb 1/2 zur Friteuse F18-E (standard F18-ETD) • FR Panier 1/2 pour F18-E (standard F18-ETD) • ES CESTA 1/2 PARA F18-E (STANDARD F18-ETD) cm. 13,5x 29x 15h			84,00 0.8 / 0,04
531033300	CESTINO 1/1 F45 EN Basket 1/1 F45 • DE korb 1/1 F45 • FR Panier 1/1 F45 • ES CESTA 1/1 F45 cm. 65x 33x 17h			219,00 3 / 0,10
531041300	CESTINO 1/2 F45, 1/1 per F18-ETD (standard in F18-E) EN Basket 1/2 F45, 1/1 for F18-ETD (standard F18-E) • DE korb 1/2 F45, 1/1 für F18-ETD (standard F18-E) • FR Panier 1/2 F45, 1/1 pour F18-ETD (standard F18-E) • ES CESTA 1/2 F45, 1/1 PARA F18-ETD (STANDARD F18-E) cm. 28x 29x 15h			91,00 1.5 / 0,06
531047800	CESTINO 1/3 F45 EN Basket 1/3 F45 • DE korb 1/3 F45 • FR Panier 1/3 F45 • ES CESTA 1/3 F45 cm. 21,5x 33x 16,5h			107,00 1.3 / 0,06
40280800	SCIVOLO inox F45 EN Stainless steel slide F45 • DE Rutsche aus Rostfreiem Stahl F45 • FR Goulotte en acier inox F45 • ES DESLIZADOR INOX F45 cm. 38x 75x 27h			170,00 5 / 0,09

ACCESSORI CUOCIPASTA

MOD. _____
COD. _____

DESCRIZIONE/DESCRIPTION/BEZEICHNUNG/DESCRIPTION/DESCRIPCIÓN
DIMENSIONI/DIMENSIONS/ABMESSUNGEN/DIMENSIONS/DIMENSIONES

POTENZA/POWER/LEISTUNG/PUISSANCE/POTENCIA
VOLTAGGIO/VOLTAGE/SPANNUNG/VOLTAGE/VOLTAJE

⚡ kW kcal/h
⚡ kw V~ Hz

PREZZO/PRICE €
PREIS/PRIX/PRECIO €
KG / M³

531070200 CESTO 1/1 PER CP-74/78
EN Basket 1/1 for CP-74/78 • **DE** Korb 1/1 für CP-74/78 • **FR** Panier 1/1 pour CP-74/78 • **ES CESTA 1/1 PARA CP-74/78**
cm. 28x 32x 21,5h



185,00
2 / 0,06

531032400 CESTO 1/2 PER CP-74/78
EN Basket 1/2 for CP-74/78 • **DE** Korb 1/2 für CP-74/78 • **FR** Panier 1/2 pour CP-74/78 • **ES CESTA 1/2 PARA CP-74/78**
cm. 14x 32x 20h

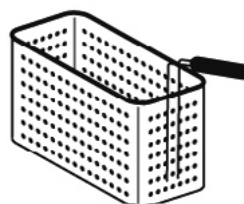

..324..

127,00
1.5 / 0,05

531047900 **cm. 28x 16x 21,5h**



133,00
1.5 / 0,04

531048000 CESTO 1/4 PER CP-74/78
EN Basket 1/4 for CP-74/78 • **DE** Korb 1/4 für CP-74/78 • **FR** Panier 1/4 pour CP-74/78 • **ES CESTA 1/4 PARA CP-74/78**
cm. 13,5x 16x 21,5h



102,00
1 / 0,02

531032600 CESTO 1/6 PER CP-74/78
EN Basket 1/6 for CP-74/78 • **DE** Korb 1/6 für CP-74/78 • **FR** Panier 1/6 pour CP-74/78 • **ES CESTA 1/6 PARA CP-74/78**
cm. 14x 10x 20h

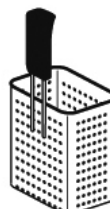

..326..

90,00
0.7 / 0,02

531053900 CESTO 1/1 PER CP-76
EN Basket 1/1 for CP-76 • **DE** Korb 1/1 für CP-76 • **FR** Panier 1/1 pour CP-76 • **ES CESTA 1/1 PARA CP-76**
cm. 49x 29x 20h

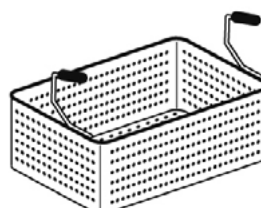

..539..

198,00
3,5 / 0,08

ACCESSORI CUOCIPASTA

MOD. _____ DESCRIZIONE/DESCRIPTION/BEZEICHNUNG/DESCRIPTION/DESCRIPCIÓN POTENZA/POWER/LEISTUNG/PUISSANCE/POTENCIA $\frac{kW}{kcal/h}$ $\frac{kW}{V\sim}$ PREZZO/PRICE €
 COD. _____ DIMENSIONI/DIMENSIONS/ABMESSUNGEN/DIMENSIONS/DIMENSIONES VOLTAGGIO/VOLTAGE/SPANNUNG/VOLTAGE/VOLTAJE Hz PREIS/PRIX/PRECIO €
 KG / M³

531017900 CESTO 1/3 PER CP-76
EN Basket 1/3 for CP-76 • **DE** Korb 1/3 für CP-76 • **FR** Panier 1/3 pour CP-76 • **ES CESTA 1/3 PARA CP-76**
 cm. 16x 29x 20h

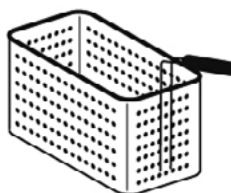

..179..

145,00
 1,5 / 0,05

531064300 CESTO 1/4 PER CP-76
EN Basket 1/4 for CP-76 • **DE** Korb 1/4 für CP-76 • **FR** Panier 1/4 pour CP-76 • **ES CESTA 1/4 PARA CP-76**
 cm. 11,5x 29x 20h

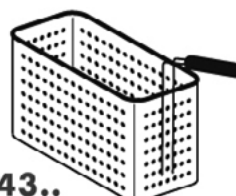

.643..

130,00
 1,2 / 0,04

531071100 CESTO CON GANCIO 1/2 PER CP-74/78
EN Basket with hook 1/2 for CP-74/78 • **DE** Korb mit Haken 1/2 für CP-74/78 • **FR** Panier avec crochet 1/2 pour CP-74/78 • **ES CESTA CON GANCHO 1/2 PARA CP-74/78**
 cm. 14,5x 29x 20h



179,00
 1,5 / 0,05

531071200 CESTO CON GANCIO 1/3 PER CP-76
EN Basket with hook 1/3 for CP-76 • **DE** Korb mit Haken 1/3 für CP-76 • **FR** Panier avec crochet 1/3 pour CP-76 • **ES CESTA CON GANCHO 1/3 PARA CP-76**
 cm. 15x 26x 20h

158,00
 1,5 / 0,05

531018700 CESTO CON GANCIO 1/4 PER CP-76
EN Basket with hook 1/4 for CP-76 • **DE** Korb mit Haken 1/4 für CP-76 • **FR** Panier avec crochet 1/4 pour CP-76 • **ES CESTA CON GANCHO 1/4 PARA CP-76**
 cm. 11x 26x 20h

131,00
 1,2 / 0,04

531069300 GRIGLIA SUPPORTO CESTI CON GANCIO PER CP-74/78
EN support for baskets with hook for CP-74/78 • **DE** Unterstützung für Körbe mit Haken für CP-74/78 • **FR** soutien pour les paniers avec crochet pour CP-74/78 • **ES SOPORTE PARA CESTAS CON GANCHO PARA CP-74/78**
 cm. 30x 33x 41h

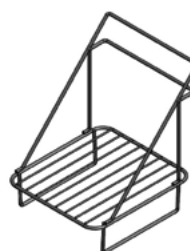

152,00
 3,5 / 0,06

531069400 GRIGLIA SUPPORTO CESTI CON GANCIO PER CP-76
EN support for baskets with hook for CP-76 • **DE** Unterstützung für Körbe mit Haken für CP-76 • **FR** soutien pour les paniers avec crochet pour CP-76 • **ES SOPORTE PARA CESTAS CON GANCHO PARA CP-76**
 cm. 50x 29x 41h

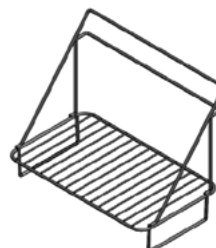

195,00
 4 / 0,09

ACCESSORI

MOD. COD.	DESCRIZIONE/DESCRIPTION/BEZEICHNUNG/DESCRIPTION/DESCRIPCIÓN DIMENSIONI/DIMENSIONS/ABMESSUNGEN/DIMENSIONS/DIMENSIONES	POTENZA/POWER/LEISTUNG/PUISSANCE/POTENCIA VOLTAGGIO/VOLTAGE/SPANNUNG/VOLTAGE/VOLTAJE	⚡ kcal/h	⚡ V~ Hz	PREZZO/PRICE PREIS/PRIX/PRECIO € KG / M³
SA-72/92 08600200	SCHIENA POSTERIORE A VISTA PER APPARECCHI EN Back cover • DE Ruckenwand • FR Dos de finition • ES PANEL POSTERIOR cm. 20x 1,5x 81h				112,00 2 / 0,01
SA-73/93 08600300	cm. 30x 1,5x 81h				127,00 3 / 0,01
SA-74/94 08600400	cm. 40x 1,5x 81h				146,00 3 / 0,01
SA-75/95 08600500	cm. 50x 1,5x 81h				184,00 4 / 0,01
SA-76/96 08600600	cm. 60x 1,5x 81h				212,00 4 / 0,02
SA-77/97 08600700	cm. 70x 1,5x 81h				225,00 5 / 0,02
SA-78/98 08600800	cm. 80x 1,5x 81h				247,00 5 / 0,02
SA-79/99 08600900	cm. 90x 1,5x 81h				278,00 6 / 0,02
SA-710/910 08601000	cm. 100x 1,5x 81h				308,00 6 / 0,03
SA-711/911 08601100	cm. 110x 1,5x 81h				341,00 7 / 0,03
SA-712/912 08601200	cm. 120x 1,5x 81h				372,00 7 / 0,03
SA-713/913 08601300	cm. 130x 1,5x 81h				403,00 8 / 0,03
SA-714/914 08601400	cm. 140x 1,5x 81h				432,00 8 / 0,04
SA-715/915 08601500	cm. 150x 1,5x 81h				462,00 10 / 0,04
SA-716/916 08601600	cm. 160x 1,5x 81h				492,00 10 / 0,04
SA-74FG 08600401	SCHIENA POSTERIORE A VISTA PER FRIGGITRICI GAS (no F2/8-74G) EN Back cover for Gas Fryer (no F2/8-74G) • DE Ruckenwand fur Gas-Friteuse (no F2/8-74G) • FR Dos de finition pour Friteuse a gaz (no F2/8-74G) • ES PANEL POSTERIOR PARA FREIDORAS A GAS (NO F2/8-74G) cm. 40x 1,5x 94h				168,00 3 / 0,01
SA-78FG 08600801	SCHIENA POSTERIORE A VISTA PER FRIGGITRICI GAS EN Back cover for Gas Fryer • DE Ruckenwand fur Gas-Friteuse • FR Dos de finition pour Friteuse a gaz • ES PANEL POSTERIOR PARA FREIDORAS A GAS cm. 80x 1,5x 94h				269,00 5 / 0,02
SA-78F45G 08600803	SCHIENA POSTERIORE A VISTA PER FRIGGITRICE GAS F45-78G EN Back cover for Gas Fryer F45-78G • DE Ruckenwand fur Gas-Friteuse F45-78G • FR Dos de finition pour Friteuse a gaz F45-78G • ES PANEL POSTERIOR PARA FREIDORAS A GAS F45-78G cm. 80x 1,5x 121h				280,00 6 / 0,03



ACCESSORI

MOD. _____ DESCRIZIONE/DESCRIPTION/BEZEICHNUNG/DESCRIPTION/DESCRIPCIÓN POTENZA/POWER/LEISTUNG/PUISSANCE/POTENCIA kW kcal/h PREZZO/PRICE €
 COD. _____ DIMENSIONI/DIMENSIONS/ABMESSUNGEN/DIMENSIONS/DIMENSIONES VOLTAGGIO/VOLTAGE/SPANNUNG/VOLTAGE/VOLTAJE V~ Hz PREIS/PRIX/PRECIO €
 KG / M³

KIT-TOPM-SA 08600001 KIT TAMPONAMENTI LATERALI per schiena posteriore montata su apparecchi TOP e mobili "M.."
EN Side KIT for back cover mounted on the TOP machine and Stand "M.."
DE Seitliches KIT für Rückenwand montiert auf der TOP-Maschine und Unterbau "M.."
FR KIT latéral pour Dos de finition monté sur la machine TOP et Placard "M.."
ES KIT LATERAL PARA PANEL POSTERIORE MONTADO EN LA MÁQUINA TOP Y MUEBLE BASE "M.."



99,00
1 / 0,01

TPA-7 08560001 TESTATA CHIUSURA PIANO (in dotazione 1 pezzo per apparecchio)
EN Head end filler strip (1 piece included in each machine)
DE Abschluss-Element (1 Stück in jeder Maschine enthalten)
FR Élément de jonction top (1 pièce incluse dans chaque machine)
ES CHAPA DE CIERRE PARA TOP (1 PIEZA INCLUIDA EN CADA EQUIPO)
cm. 0,2x 70,5



77,00
1 / 0,00

TMA-7SX 08540701 TESTATA 1 LATO SERIE 70 SINISTRA
EN Head 1 side S70 left
DE Abschluss element 1 seite S70 links
FR Element de jonction 1 coté S70 gauche
ES EMBELLECEDOR 1 LADO S70 IZQUIERDA
cm. 0,2x 70,5



280,00
8 / 1,00

TMA-7DX 08540700 TESTATA 1 LATO SERIE 70 DESTRA
EN Head 1 side S70 right
DE Abschluss element 1 seite S70 recht
FR Element de jonction 1 coté S70 droit
ES EMBELLECEDOR 1 LADO S70 DERECHA
cm. 0,2x 70,5



280,00
8 / 1,00

TMA-77 08547700 TESTATA 2 LATI SERIE 70
EN Head 2 sides S70
DE Abschluss element seiten S70
FR Element de jonction 2 cotés S70
ES EMBELLECEDOR 2 LADOS S70
cm. 0,2x 141



562,00
16 / 1,00

TMA-79SX 08547901 TESTATA 2 LATI SERIE 70/90 SINISTRA
EN Head 2 sides S70/90 left
DE Abschluss element seiten S70/90 links
FR Element de jonction 2 cotés S70/90 gauche
ES EMBELLECEDOR 2 LADOS S70/90 IZQUIERDA
cm. 0,2x160,5



575,00
18 / 1,00

ACCESSORI

MOD. _____ DESCRIZIONE/DESCRIPTION/BEZEICHNUNG/DESCRIPTION/DESCRIPCIÓN POTENZA/POWER/LEISTUNG/PUISSANCE/POTENCIA ⚡kw ⚡kw PREZZO/PRICE €
 COD. _____ DIMENSIONI/DIMENSIONS/ABMESSUNGEN/DIMENSIONS/DIMENSIONES VOLTAGGIO/VOLTAGE/SPANNUNG/VOLTAGE/VOLTAJE kcal/h V~ Hz PREIS/PRIX/PRECIO €
 KG / M³

TMA-79DX TESTATA 2 LATI SERIE 70/90 DESTRA
 08547900 **EN** Head 2 sides S70/90 right • **DE** Abschluss element seiten S70/90 recht • **FR** Element de jonction 2 cotés S70/90 droit • **ES** **EMBELLECEDOR 2 LADOS S70/90 DERECHA**
cm. 0,2x160,5



575,00
 18 / 1,00

TMTA-75X TESTATA TAMBURATA 1 LATO SERIE 70 SINISTRA, con stesso profilo linea frontale
 08540721 **EN** Head 1 side S70 left, with the same front line profile • **DE** Abschluss element 1 seite S70 links, mit dem gleichen Frontlinienprofil • **FR** Element de jonction 1 coté S70 gauche, avec le même profil de ligne • **ES** **EMBELLECEDOR 1 LADO S70 IZQUIERDA, CON EL MISMO PERFIL DE LÍNEA FRONTAL**
cm. 7,5x 70,5



881,00
 14 / 0,16

TMTA-7DX TESTATA TAMBURATA 1 LATO SERIE 70 DESTRA, con stesso profilo linea frontale
 08540720 **EN** Head 1 side S70 right, with the same front line profile • **DE** Abschluss element 1 seite S70 recht, mit dem gleichen Frontlinienprofil • **FR** Element de jonction 1 coté S70 droit, avec le même profil de ligne • **ES** **EMBELLECEDOR 1 LADO S70 DERECHA, CON EL MISMO PERFIL DE LÍNEA FRONTAL**
cm. 7,5x 70,5



881,00
 14 / 0,16

TMTA-77 TESTATA TAMBURATA 2 LATI SERIE 70, con stesso profilo linea frontale
 08547720 **EN** Head 2 sides S70, with the same front line profile • **DE** Abschluss element seiten S70, mit dem gleichen Frontlinienprofil • **FR** Element de jonction 2 cotés S70, avec le même profil de ligne • **ES** **EMBELLECEDOR 2 LADOS S70, CON EL MISMO PERFIL DE LÍNEA FRONTAL**
cm. 7,5x 141



1.705,00
 28 / 0,30

TMTA-79SX TESTATA TAMBURATA 2 LATI SERIE 70/90 SINISTRA, con stesso profilo linea frontale
 08547921 **EN** Head 2 sides S70/90 left, with the same front line profile • **DE** Abschluss element seiten S70/90 links, mit dem gleichen Frontlinienprofil • **FR** Element de jonction 2 cotés S70/90 gauche, avec le même profil de ligne • **ES** **EMBELLECEDOR 2 LADOS S70/90 IZQUIERDA, CON EL MISMO PERFIL DE LÍNEA FRONTAL**
cm. 7,5x160,5



1.732,00
 30 / 0,34

TMTA-79DX TESTATA TAMBURATA 2 LATI SERIE 70/90 DESTRA, con stesso profilo linea frontale
 08547920 **EN** Head 2 sides S70/90 right, with the same front line profile • **DE** Abschluss element seiten S70/90 recht, mit dem gleichen Frontlinienprofil • **FR** Element de jonction 2 cotés S70/90 droit, avec le même profil de ligne • **ES** **EMBELLECEDOR 2 LADOS S70/90 DERECHA, CON EL MISMO PERFIL DE LÍNEA FRONTAL**
cm. 7,5x160,5



1.732,00
 30 / 0,34

ACCESSORI

MOD. COD.	DESCRIZIONE/DESCRIPTION/BEZEICHNUNG/DESCRIPTION/DESCRIPCIÓN DIMENSIONI/DIMENSIONS/ABMESSUNGEN/DIMENSIONS/DIMENSIONES	POTENZA/POWER/LEISTUNG/PUISSANCE/POTENCIA VOLTAGGIO/VOLTAGE/SPANNUNG/VOLTAGE/VOLTAJE	⊕kW kcal/h	⊖kW V~ Hz	PREZZO/PRICE PREIS/PRIX/PRECIO €/KG / M³
TSP-4 18400400	COPPIA TRAVERSE SUPPORTO PONTE EN Support for bridge type system • DE Bruckengestell • FR Support en pont cm. 40x 6x 6				233,00 / 0,01
TSP-6 18400600	cm. 60x 6x 6				262,00 / 0,01
TSP-8 18400800	cm. 80x 6x 6				294,00 / 0,01
TSP-10 18401000	cm. 100x 6x 6				326,00 / 0,02
TSP-12 18401200	cm. 120x 6x 6				354,00 / 0,02
TSP-14 18401400	cm. 140x 6x 6				384,00 / 0,02
TSP-16 18401600	cm. 160x 6x 6				409,00 / 0,03
TSP-18 18401800	cm. 180x 6x 6				449,00 / 0,03
TSP-20 18402000	cm. 200x 6x 6				471,00 / 0,03
09610800	MITRA 800 EN Chimney jack 800 • DE Lüftungsaufsatz 800 • FR Mitre 800 • ES CAPERUZA 800 cm. 80x 7x 92h				632,00 16 / 0,04
09611200	MITRA 1200 EN Chimney jack 1200 • DE Lüftungsaufsatz 1200 • FR Mitre 1200 • ES CAPERUZA 1200 cm. 120x 7x 92h				845,00 24 / 0,06
08610802	MITRA 800 per F45-78G EN Chimney jack 800 • DE Lüftungsaufsatz 800 • FR Mitre 800 • ES CAPERUZA 800 cm. 80x 7x 52h				632,00 16 / 0,04
09610801	CAMINO ANTIVENTO 800 EN Draught diverter 800 • DE Strömungssicherung 800 • FR Cheminee anti-vent 800 • ES CHIMENEA CONTRA VIENTO 800 cm. 80x 19x 120h				889,00 16 / 0,15
09611201	CAMINO ANTIVENTO 1200 EN Draught diverter 1200 • DE Strömungssicherung 1200 • FR Cheminee anti-vent 1200 • ES CHIMENEA CONTRA VIENTO 1200 cm. 120x 19x 120h				1.173,00 24 / 0,25
08610803	CAMINO ANTIVENTO 800 per F45-78G EN Draught diverter 800 for F45-78G • DE Strömungssicherung 800 für F45-78G • FR Cheminee anti-vent 800 pour F45-78G • ES CHIMENEA CONTRA VIENTO 800 PARA F45-78G cm. 80x 19x 77h				889,00 16 / 0,15

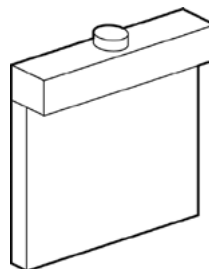
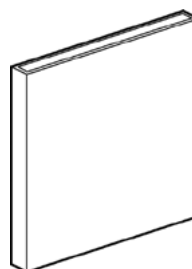
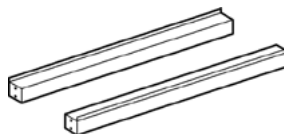

ACCESSORI

MOD. COD.	DESCRIZIONE/DESCRIPTION/BEZEICHNUNG/DESCRIPTION/DESCRIPCIÓN DIMENSIONI/DIMENSIONS/ABMESSUNGEN/DIMENSIONS/DIMENSIONES	POTENZA/POWER/LEISTUNG/PUISSANCE/POTENCIA VOLTAGGIO/VOLTAGE/SPANNUNG/VOLTAGE/VOLTAJE	⚡kW kcal/h	⚡kw V~ Hz	PREZZO/PRICE PREIS/PRIX/PRECIO € KG / M ³
08570103	Mensola anteriore EN Earlier shelf • DE Frühere Regal • FR Plus tôt plateau • ES A PRINCIPIOS DE LA PLATAFORMA cm. 30x 21x 5h				438,00 / 0,01
08570104	cm. 40x 21x 5h				451,00 / 0,01
08570105	cm. 50x 21x 5h				464,00 / 0,01
08570106	cm. 60x 21x 5h				477,00 / 0,01
08570107	cm. 70x 21x 5h				488,00 / 0,01
08570108	cm. 80x 21x 5h				500,00 / 0,01
08570109	cm. 90x 21x 5h				514,00 / 0,02
08570110	cm. 100x 21x 5h				526,00 / 0,02
08570111	cm. 110x 21x 5h				541,00 / 0,02
08570112	cm. 120x 21x 5h				555,00 / 0,02
08570113	cm. 130x 21x 5h				573,00 / 0,02
08570114	cm. 140x 21x 5h				586,00 / 0,02
08570115	cm. 150x 21x 5h				605,00 / 0,02
08570116	cm. 160x 21x 5h				622,00 / 0,03

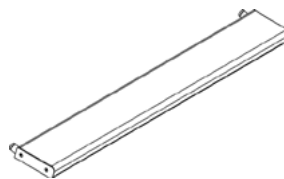

ACCESSORI

MOD. COD.	DESCRIZIONE/DESCRIPTION/BEZEICHNUNG/DESCRIPTION/DESCRIPCIÓN DIMENSIONI/DIMENSIONS/ABMESSUNGEN/DIMENSIONS/DIMENSIONES	POTENZA/POWER/LEISTUNG/PUISSANCE/POTENCIA VOLTAGGIO/VOLTAGE/SPANNUNG/VOLTAGE/VOLTAJE	kw kcal/h	kw V~ Hz	PREZZO/PRICE PREIS/PRIX/PRECIO € KG / M ³
08570002	Corrimano EN Handrail • DE Hand Lauf • FR Main courante • ES PASAMANO cm. 20x 7x 4h				368,00 / 0,00
08570003	cm. 30x 7x 4h				374,00 / 0,00
08570004	cm. 40x 7x 4h				378,00 / 0,00
08570005	cm. 50x 7x 4h				388,00 / 0,00
08570006	cm. 60x 7x 4h				401,00 / 0,00
08570007	cm. 70x 7x 4h				407,00 / 0,00
08570008	cm. 80x 7x 4h				414,00 / 0,01
08570009	cm. 90x 7x 4h				420,00 / 0,01
08570010	cm. 100x 7x 4h				427,00 / 0,01
08570011	cm. 110x 7x 4h				438,00 / 0,01
08570012	cm. 120x 7x 4h				451,00 / 0,01
08570013	cm. 130x 7x 4h				465,00 / 0,01
08570014	cm. 140x 7x 4h				482,00 / 0,01
08570015	cm. 150x 7x 4h				525,00 / 0,01
08570016	cm. 160x 7x 4h				568,00 / 0,01
533116300	Giunzione corrimano EN junction handrail • DE Gelenk Hand lauf • FR Main courante de l'embranchement • ES CONEXIÓN PASAMANO cm. Ø 3x 2,4				58,00 / 1,00

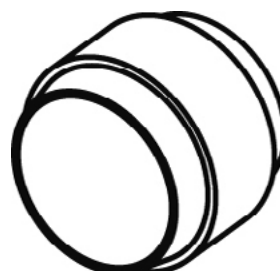
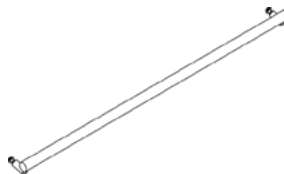

ACCESSORI

MOD.
COD.

DESCRIZIONE/DESCRIPTION/BEZEICHNUNG/DESCRIPTION/DESCRIPCIÓN
DIMENSIONI/DIMENSIONS/ABMESSUNGEN/DIMENSIONS/DIMENSIONES

POTENZA/POWER/LEISTUNG/PUISSANCE/POTENCIA
VOLTAGGIO/VOLTAGE/SPANNUNG/VOLTAGE/VOLTAJE

⚡kW
kcal/h

⚡kw
V~
Hz

PREZZO/PRICE €
PREIS/PRIX/PRECIO €
KG / M²

ZB
01410000

ZOCCOLATURA BASE
EN FRONT PLINTH • DE GRUNDSOCKEL • FR PLINTHE FRONTAL
• ES ZOCOLOS BASE
€/m x cm. 15h

154,00
/

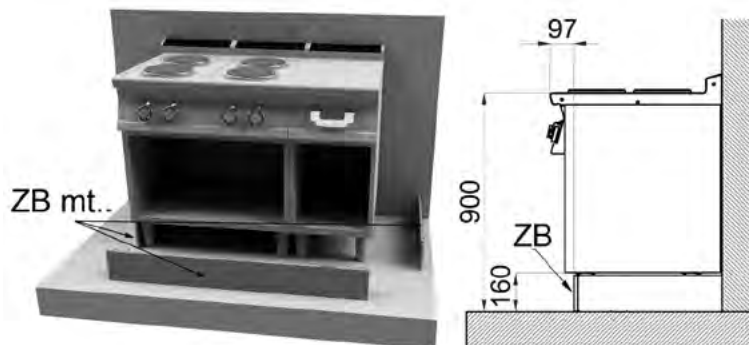

FZ-7
08480001

ZOCCOLATURA LATERALE - KIT
EN side plinth - kit • DE seitensockel - kit • FR plinthe lateral - kit
• ES ZOCOLOS LATERAL - KIT
cm. 1,5x 61x 6h

318,00
/ 0,02



CZ-72/92
08480002

KIT CASSETTO ZOCCOLO, inclusi 4 piedini
EN drawer clog - kit (4 small feet included) • DE schubladen sockel - kit
(4 kleine FüÙe enthalten) • FR tiroir plinthe - kit (4 petits pieds inclus)
• ES CAJON ZOCOLOS - KIT (4 PIES PEQUENO INDLUIDO)
cm. 20x 61x 5,5h

186,00
3 / 0,01



CZ-73
08480003

cm. 30x 61x 5,5h

216,00
3.5 / 0,02

CZ-74
08480004

cm. 40x 61x 5,5h

247,00
4 / 0,02

CZ-76
08480006

cm. 60x 61x 5,5h

326,00
5 / 0,03

CZ-78
08480008

cm. 80x 61x 5,5h

408,00
7 / 0,04

CZ-712
08480012

cm. 120x 61x 5,5h

570,00
8 / 0,06

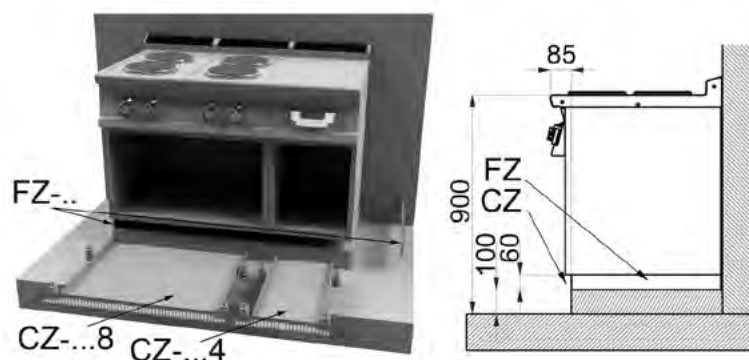

PIANI LAVORO - TOP

MOD. _____ DESCRIZIONE/DESCRIPTION/BEZEICHNUNG/DESCRIPTION/DESCRIPCIÓN POTENZA/POWER/LEISTUNG/PUISSANCE/POTENCIA kW kcal/h kw V~ Hz PREZZO/PRICE € PREIS/PRIX/PRECIO KG / M³
 COD. _____ DIMENSIONI/DIMENSIONS/ABMESSUNGEN/DIMENSIONS/DIMENSIONES VOLTAGGIO/VOLTAGE/SPANNUNG/VOLTAGE/VOLTAJE

PLT-72 PIANO LAVORO (inclusa 1 testata chiusura piano mod.TPA-7) **611,00**
 18010200 **EN** Worktop (included 1 Head end filler strip mod.TPA-7) • **DE** **15 / 0,18**
 Arbeitsplatte (inbegriffen 1 Abschluss-Element mod.TPA-7) • **FR** Plan de **ES SOBRE DE**
 travail (inclus 1 Elément de jonction top mod.TPA-7) • **ES SOBRE DE**
TRABAJO (INCLUIDA 1 CHAPA DE CIERRE PARA TOP MOD. TPA-7)
cm. 20x 70,5x 28h



PLST-73 **cm. 30x 70,5x 28h** **652,00**
 18010301 **20 / 0,18**



PLST-74 **cm. 40x 70,5x 28h** **670,00**
 18010401 **22 / 0,18**



PLST-76 **cm. 60x 70,5x 28h** **873,00**
 18010601 **27 / 0,26**



PLST-78 **cm. 80x 70,5x 28h** **994,00**
 18010801 **33 / 0,35**



PLT-73 PIANO LAVORO Cassetto con 1 bacinella: cm. 19x50x15h inox (inclusa 1 **935,00**
 18010300 testata chiusura piano mod.TPA-7) **23 / 0,18**
EN Worktop Drawer with 1 container: cm. 19x50x15h inox (included **ES SOBRE DE**
 1 Head end filler strip mod.TPA-7) • **DE** Arbeitsplatte Schublade mit **TRABAJO CAJÓN CON 1 CONTENEDORE: CM. 19X50X15H**
 1 Behälter: cm. 19x50x15h inox (inbegriffen 1 Abschluss-Element **INOX (INCLUIDA 1 CHAPA DE CIERRE PARA TOP MOD.TPA-7)**
 mod.TPA-7) • **FR** Plan de travail Tiroir avec 1 bac: cm. 19x50x15h **cm. 30x 70,5x 28h**
 inox (inclus 1 Elément de jonction top mod.TPA-7)



PIANI LAVORO - TOP

MOD. _____
COD. _____

DESCRIZIONE/DESCRIPTION/BEZEICHNUNG/DESCRIPTION/DESCRIPCIÓN
DIMENSIONI/DIMENSIONS/ABMESSUNGEN/DIMENSIONS/DIMENSIONES

POTENZA/POWER/LEISTUNG/PUISSANCE/POTENCIA
VOLTAGGIO/VOLTAGE/SPANNUNG/VOLTAGE/VOLTAJE

⚡ kW _____
kcal/h _____
⚡ kw _____
V~ _____
Hz _____

PREZZO/PRICE €
PREIS/PRIX/PRECIO €
KG / M³

PLT-74
18010400

PIANO LAVORO Cassetto con 1 bacinella GN 1/1 15h plastica (inclusa 1 testata chiusura piano mod.TPA-7)
EN Worktop - Drawer with 1 plastic container GN 1/1 15h (included 1 Head end filler strip mod.TPA-7) • **DE** Arbeitsplatte - Schublade mit 1 GN 1/1 15h Kunststoffbehälter (inbegriffen 1 Abschluss-Element mod.TPA-7) • **FR** Plan de travail - tiroir avec bac en plastique GN 1/1 15h (inclus 1 Élément de jonction top mod.TPA-7) • **ES SOBRE DE TRABAJO CAJÓN CON 1 CONTENEDOR GN 1/1 15H PLÁSTICO (INCLUIDA 1 CHAPA DE CIERRE PARA TOP MOD.TPA-7)**
cm. 40x 70,5x 28h



946,00
26 / 0,18

PLT-76
18010600

PIANO LAVORO Cassetto con 1 bacinella: cm. 49x50x15h inox (inclusa 1 testata chiusura piano mod.TPA-7)
EN Worktop Drawer with 1 container: cm. 49x50x15h inox (included 1 Head end filler strip mod.TPA-7) • **DE** Arbeitsplatte Schublade mit 1 Behälter: cm. 49x50x15h inox (inbegriffen 1 Abschluss-Element mod.TPA-7) • **FR** Plan de travail Tiroir avec 1 bac: cm. 49x50x15h inox (inclus 1 Élément de jonction top mod.TPA-7) • **ES SOBRE DE TRABAJO CAJÓN CON 1 CONTENEDORE: CM. 49X50X15H INOX (INCLUIDA 1 CHAPA DE CIERRE PARA TOP MOD.TPA-7)**
cm. 60x 70,5x 28h



1.180,00
36 / 0,26

PLT-78
18010800

PIANO LAVORO Cassetto con 2 bacinelle GN 1/1 15h plastica (inclusa 1 testata chiusura piano mod.TPA-7)
EN Worktop - Drawer with 2 plastic containers GN 1/1 15h (included 1 Head end filler strip mod.TPA-7) • **DE** Arbeitsplatte - Schublade mit 2 GN 1/1 15h Kunststoffbehältern (inbegriffen 1 Abschluss-Element mod.TPA-7) • **FR** Plan de travail - Tiroir avec 2 bacs en plastique GN 1/1 15h (inclus 1 Élément de jonction top mod.TPA-7) • **ES SOBRE DE TRABAJO CAJÓN CON 2 CONTENEDORES GN 1/1 15H PLÁSTICO (INCLUIDA 1 CHAPA DE CIERRE PARA TOP MOD.TPA-7)**
cm. 80x 70,5x 28h



1.332,00
43 / 0,35

LAT-74
18020400

LAVELLO Rubinetto a leva - Vasca cm. 30x35x15h (inclusa 1 testata chiusura piano mod.TPA-7)
EN Sink unit - Lever type tap - Bowl cm. 30x35x15h (included 1 Head end filler strip mod.TPA-7) • **DE** Spülbecken - Einhebel-Mischbatterie Becken cm. 30x35x15h (inbegriffen 1 Abschluss-Element mod.TPA-7) • **FR** Bac-évier avec robinetterie - Bac cm 30x35x15h (inclus 1 Élément de jonction top mod.TPA-7) • **ES FREGADERO - GRIFO A PALANCA - PILETA CM. 30X35X15H (INCLUIDA 1 CHAPA DE CIERRE PARA TOP MOD.TPA-7)**
cm. 40x 70,5x 28h



1.158,00
22 / 0,18

PCT-74ET
18030430

PIANO COTTURA TRIFASE - N. 2 piastre (inclusa 1 testata chiusura piano mod.TPA-7)
EN Boiling unit threephase - N. 2 plates (included 1 Head end filler strip mod.TPA-7) • **DE** Kochplatte dreiphasig - N. 2 Kochplatten (inbegriffen 1 Abschluss-Element mod.TPA-7) • **FR** Rechaud électriques - N. 2 plaques (inclus 1 Élément de jonction top mod.TPA-7) • **ES SOBRE DE COCCIÓN TRIFÁSICO - N. 2 PLANCHAS (INCLUIDA 1 CHAPA DE CIERRE PARA TOP MOD.TPA-7)**
cm. 40x 70,5x 28h



⚡ 5,2 kW _____
400V~2N _____
230V~3 _____
230V~ _____
50/60 Hz _____

994,00
26 / 0,18



PCT-78ET
18030830

PIANO COTTURA TRIFASE N. 4 piastre (inclusa 1 testata chiusura piano mod.TPA-7)
EN Boiling unit threephase - N. 4 plates (included 1 Head end filler strip mod.TPA-7) • **DE** Kochplatte dreiphasig - N. 4 Kochplatten (inbegriffen 1 Abschluss-Element mod.TPA-7) • **FR** Rechaud électriques - N. 4 plaques (inclus 1 Élément de jonction top mod.TPA-7) • **ES SOBRE DE COCCIÓN TRIFÁSICO - N. 4 PLANCHAS (INCLUIDA 1 CHAPA DE CIERRE PARA TOP MOD.TPA-7)**
cm. 80x 70,5x 28h



⚡ 10,4 kW _____
400V~3N _____
230V~3 _____
50/60 Hz _____

1.574,00
63 / 0,35

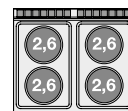

PIANI COTTURA ELETTRICI - TOP

MOD. / COD. DESCRIZIONE / DESCRIPTION / BEZEICHNUNG / DESCRIPTION / DESCRIPCIÓN DIMENSIONI / DIMENSIONS / ABMESSUNGEN / DIMENSIONS / DIMENSIONES POTENZA / POWER / LEISTUNG / PUISSANCE / POTENCIA VOLTAGGIO / VOLTAGE / SPANNUNG / VOLTAGE / VOLTAJE $\frac{kW}{kcal/h}$ $\frac{kW}{V \sim}$ Hz PREZZO / PRICE € PREIS / PRIX / PRECIO € KG / M³

PCT-712ET
18031230
PIANO COTTURA TRIFASE N. 6 piastre (inclusa 1 testata chiusura piano mod.TPA-7)
EN Boiling unit threephase - N. 6 plates (included 1 Head end filler strip mod.TPA-7) • **DE** Kochplatte dreiphasig - N. 6 Kochplatten (inbegriffen 1 Abschluss-Element mod.TPA-7) • **FR** Rechaud électriques - N. 6 plaques (inclus 1 Élément de jonction top mod.TPA-7) • **ES SOBRE DE COCCIÓN TRIFÁSICO - N. 6 PLANCHAS (INCLUIDA 1 CHAPA DE CIERRE PARA TOP MOD.TPA-7)**
cm. 120x 70,5x 28h



15,6 kW
400V~3N
230V~3
50/60 Hz

2.514,00
82 / 0,51

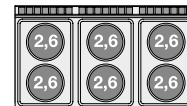

PCQT-74ET
18030431
PIANO COTTURA TRIFASE - N. 2 piastre quadre (inclusa 1 testata chiusura piano mod.TPA-7)
EN Boiling unit threephase - N. 2 square plates (included 1 Head end filler strip mod.TPA-7) • **DE** Kochplatte dreiphasig - N. 2 quadratischen Platten (inbegriffen 1 Abschluss-Element mod.TPA-7) • **FR** Rechaud électriques - N. 2 plaques carrés (inclus 1 Élément de jonction top mod.TPA-7) • **ES SOBRE DE COCCIÓN TRIFÁSICO - N. 2 PLANCHAS CUADRADAS (INCLUIDA 1 CHAPA DE CIERRE PARA TOP MOD.TPA-7)**
cm. 40x 70,5x 28h



5,2 kW
400V~2N
230V~3
230V~
50/60 Hz

1.712,00
30 / 0,18



PCQT-78ET
18030831
PIANO COTTURA TRIFASE - N. 4 piastre quadre (inclusa 1 testata chiusura piano mod.TPA-7)
EN Boiling unit threephase - N. 4 square plates (included 1 Head end filler strip mod.TPA-7) • **DE** Kochplatte dreiphasig - N. 4 quadratischen Platten (inbegriffen 1 Abschluss-Element mod.TPA-7) • **FR** Rechaud électriques - N. 4 plaques carrés (inclus 1 Élément de jonction top mod.TPA-7) • **ES SOBRE DE COCCIÓN TRIFÁSICO - N. 4 PLANCHAS CUADRADAS (INCLUIDA 1 CHAPA DE CIERRE PARA TOP MOD.TPA-7)**
cm. 80x 70,5x 28h



10,4 kW
400V~3N
230V~3
50/60 Hz

2.921,00
66 / 0,35

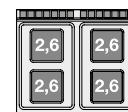

PCQT-712ET
18031231
PIANO COTTURA TRIFASE - N. 6 piastre quadre (inclusa 1 testata chiusura piano mod.TPA-7)
EN Boiling unit threephase - N. 6 square plates (included 1 Head end filler strip mod.TPA-7) • **DE** Kochplatte dreiphasig - N. 6 quadratischen Platten (inbegriffen 1 Abschluss-Element mod.TPA-7) • **FR** Rechaud électriques - N. 6 plaques carrés (inclus 1 Élément de jonction top mod.TPA-7) • **ES SOBRE DE COCCIÓN TRIFÁSICO - N. 6 PLANCHAS CUADRADAS (INCLUIDA 1 CHAPA DE CIERRE PARA TOP MOD.TPA-7)**
cm. 120x 70,5x 28h



15,6 kW
400V~3N
230V~3
50/60 Hz

4.531,00
97 / 0,51

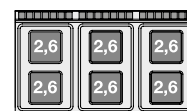

PCCT-74ET
18030432
PIANO COTTURA VETROKERAMICA TRIFASE - N. 2 zone - vetro cm.35x57 (inclusa 1 testata chiusura piano mod.TPA-7)
EN Ceramic glass boiling unit - n. 2 zones - glass cm.35x57 (included 1 Head end filler strip mod.TPA-7) • **DE** Ceran-Kochplatte dreiphasig - 2 zonen - Glas 35x57 cm (inbegriffen 1 Abschluss-Element mod.TPA-7) • **FR** Plan de cuisson à vitroceramique triphasé N. 2 zones - Verre cm.35x57 (inclus 1 Élément de jonction top mod.TPA-7) • **ES SOBRE DE COCCIÓN TRIFÁSICO VITROCERÁMICA - 2 ZONAS - VIDRO CM.35X57 (INCLUIDA 1 CHAPA DE CIERRE PARA TOP MOD.TPA-7)**
cm. 40x 70,5x 28h

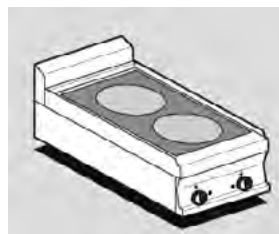

5 kW
400V~2N
230V~3
230V~
50/60 Hz

2.090,00
35 / 0,18



PCCT-78ET
18030832
PIANO COTTURA VETROKERAMICA TRIFASE - N. 4 zone - vetro cm.75x57 (inclusa 1 testata chiusura piano mod.TPA-7)
EN Ceramic glass boiling unit - n. 4 zones - glass cm.75x57 (included 1 Head end filler strip mod.TPA-7) • **DE** Ceran-Kochplatte dreiphasig - 4 zonen - Glas 75x57 cm (inbegriffen 1 Abschluss-Element mod.TPA-7) • **FR** Plan de cuisson à vitroceramique triphasé N. 4 zones - Verre cm.75x57 (inclus 1 Élément de jonction top mod.TPA-7) • **ES SOBRE DE COCCIÓN TRIFÁSICO VITROCERÁMICA - 4 ZONAS - VIDRO CM.75X57 (INCLUIDA 1 CHAPA DE CIERRE PARA TOP MOD.TPA-7)**



10 kW
400V~3N
230V~3
50/60 Hz

3.170,00
62 / 0,35

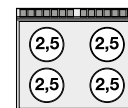

PIANI COTTURA A INDUZIONE - TOP

MOD. _____
COD. _____

DESCRIZIONE/DESCRIPTION/BEZEICHNUNG/DESCRIPTION/DESCRIPCIÓN
DIMENSIONI/DIMENSIONS/ABMESSUNGEN/DIMENSIONS/DIMENSIONES

POTENZA/POWER/LEISTUNG/PUISSANCE/POTENCIA
VOLTAGGIO/VOLTAGE/SPANNUNG/VOLTAGE/VOLTAGE

⚡ kW _____
kcal/h _____
V~ _____
Hz _____

PREZZO/PRICE €
PREIS/PRIX/PRECIO €
KG / M³

PCIT-74ET
18030433

PIANO COTTURA INDUZIONE TRIFASE - N. 2 zone - Vetro cm.35x57 (non posizionare su forni o cassettiere) (inclusa 1 testata chiusura piano mod.TPA-7)

EN Three-phase induction cooking - 2 zones - glass cm.35x57 (do not place on ovens or drawers) (included 1 Head end filler strip mod.TPA-7)

• **DE** Induktions-Kochplatte dreiphasig - 2 zonen - Glas 35x57 cm (nicht Platz auf Öfen oder Schubladen) (inbegriffen 1 Abschluss-Element mod.TPA-7) • **FR** Plan de cuisson à induction triphasé N. 2 zones - Verre cm.35x57 (ne placez pas sur des fours ou des tiroirs) (inclus 1

Élément de jonction top mod.TPA-7) • **ES ENCIMERA INDUCCIÓN TRIFÁSICA - 2 ZONAS - VIDRIO CM.35X57 (NO COLOQUE EN LOS HORNOS O EN LOS CAJONES) (INCLUIDA 1 CHAPA DE CIERRE PARA TOP MOD.TPA-7)**

cm. 40x 70,5x 28h



⚡ 10 kW _____
400V~3 _____
50/60 Hz _____

8.477,00
34 / 0,18

PCIWT-74ET
18030434

PIANO COTTURA INDUZIONE TRIFASE "WOK" - N. 1 zona - Vetro Ø 30 cm. (non posizionare su forni o cassettiere) (inclusa 1 testata chiusura piano mod.TPA-7)

EN Three-phase induction cooking "WOK" - 1 zone - glass Ø 30 cm (do not place on ovens or drawers) (included 1 Head end filler strip mod.TPA-7) • **DE** Induktions-Kochplatte "WOK" dreiphasig - 1 zonen - Glas Ø 30 cm (nicht Platz auf Öfen oder Schubladen) (inbegriffen 1

Abschluss-Element mod.TPA-7) • **FR** Plan de cuisson à induction "WOK" triphasé N. 1 zone - Verre cm Ø 30 (ne placez pas sur des fours ou des tiroirs) (inclus 1 Élément de jonction top mod.TPA-7) • **ES ENCIMERA INDUCCIÓN "WOK" TRIFÁSICA - 1 ZONA - VIDRIO Ø 30 CM (NO COLOQUE EN LOS HORNOS O EN LOS CAJONES)**

(INCLUIDA 1 CHAPA DE CIERRE PARA TOP MOD.TPA-7)

cm. 40x 70,5x 28h



⚡ 5 kW _____
400V~3 _____
50/60 Hz _____

6.376,00
32 / 0,18

PIANI COTTURA A INDUZIONE - TOP

MOD. _____
COD. _____

DESCRIZIONE/DESCRIPTION/BEZEICHNUNG/DESCRIPTION/DESCRIPCIÓN
DIMENSIONI/DIMENSIONS/ABMESSUNGEN/DIMENSIONS/DIMENSIONES

POTENZA/POWER/LEISTUNG/PUISSANCE/POTENCIA
VOLTAGGIO/VOLTAGE/SPANNUNG/VOLTAGE/VOLTAJE

$\frac{kW}{kcal/h}$ $\frac{kW}{V-}$
Hz

PREZZO/PRICE €
PREIS/PRIX/PRECIO €
KG / M³

PCIT-78ET
18030833

PIANO COTTURA INDUZIONE TRIFASE - N. 4 zone - Vetro cm.75x57 (non posizionare su forni o cassettiere) (inclusa 1 testata chiusura piano mod.TPA-7)

EN Three-phase induction cooking - 4 zones - glass cm.75x57 (do not place on ovens or drawers) (included 1 Head end filler strip mod.TPA-7)

• **DE** Induktions-Kochplatte dreiphasig - 4 zonen - Glas 75x57 cm (nicht Platz auf Öfen oder Schubladen) (inbegriffen 1 Abschluss-Element mod.TPA-7) • **FR** Plan de cuisson à induction triphasé N. 4 zones - Verre cm.75x57 (ne placez pas sur des fours ou des tiroirs) (inclus 1 Élément de jonction top mod.TPA-7) • **ES ENCIMERA INDUCCIÓN TRIFÁSICA - 4 ZONAS - VIDRIO CM.75X57 (NO COLOQUE EN LOS HORNOS O EN LOS CAJONES) (INCLUIDA 1 CHAPA DE CIERRE PARA TOP MOD.TPA-7)**

cm. 80x 70,5x 28h

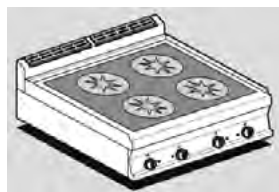

$\frac{20 kW}{400V-3}$ **15.878,00**
 $\frac{11.180 kcal/h}{50/60 Hz}$ 66 / 0,35

PCT-74GP
18210450

PIANO COTTURA GAS 2 fuochi (inclusa 1 testata chiusura piano mod. TPA-7)

EN Gas heated boiling unit - 2 burners (included 1 Head end filler strip mod.TPA-7) • **DE** Gas-kochplatte - 2 Kochstellen (inbegriffen 1 Abschluss-Element mod.TPA-7) • **FR** Rechaud gaz - 2 feux vifs (inclus 1 Élément de jonction top mod.TPA-7) • **ES SOBRES DE COCCIÓN GAS - 2 QUEMADORES (INCLUIDA 1 CHAPA DE CIERRE PARA TOP MOD.TPA-7)**

cm. 40x 70,5x 28h



$\frac{13 kW}{11.180 kcal/h}$ **1.580,00**
60 / 0,18

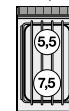

PCT-78GP
18210850

PIANO COTTURA GAS 4 fuochi (inclusa 1 testata chiusura piano mod. TPA-7)

EN Gas heated boiling unit - 4 burners (included 1 Head end filler strip mod.TPA-7) • **DE** Gas-kochplatte - 4 Kochstellen (inbegriffen 1 Abschluss-Element mod.TPA-7) • **FR** Rechaud gaz - 4 feux vifs (inclus 1 Élément de jonction top mod.TPA-7) • **ES SOBRES DE COCCIÓN GAS - 4 QUEMADORES (INCLUIDA 1 CHAPA DE CIERRE PARA TOP MOD.TPA-7)**

cm. 80x 70,5x 28h



$\frac{22 kW}{18.920 kcal/h}$ **2.731,00**
73 / 0,35

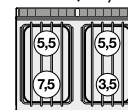

PCT-712GP
18211250

PIANO COTTURA GAS 6 fuochi (inclusa 1 testata chiusura piano mod. TPA-7)

EN Gas heated boiling unit - 6 burners (included 1 Head end filler strip mod.TPA-7) • **DE** Gas-kochplatte - 6 Kochstellen (inbegriffen 1 Abschluss-Element mod.TPA-7) • **FR** Rechaud gaz - 6 feux vifs (inclus 1 Élément de jonction top mod.TPA-7) • **ES SOBRES DE COCCIÓN GAS - 6 QUEMADORES (INCLUIDA 1 CHAPA DE CIERRE PARA TOP MOD.TPA-7)**

cm. 120x 70,5x 28h



$\frac{35 kW}{30.100 kcal/h}$ **3.924,00**
119 / 0,51

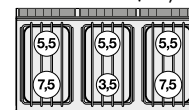

PCIT-74G
18210453

PIANO COTTURA GAS 1 fuoco (inclusa 1 testata chiusura piano mod. TPA-7)

EN Gas heated boiling unit - 1 burner (included 1 Head end filler strip mod.TPA-7) • **DE** Gas-kochplatte - 1 Kochstellen (inbegriffen 1 Abschluss-Element mod.TPA-7) • **FR** Rechaud gaz - 1 feux vifs (inclus 1 Élément de jonction top mod.TPA-7) • **ES SOBRES DE COCCIÓN GAS - 1 QUEMADOR (INCLUIDA 1 CHAPA DE CIERRE PARA TOP MOD.TPA-7)**

cm. 40x 70,5x 28h



$\frac{10 kW}{8.600 kcal/h}$ **1.835,00**
60 / 0,18



PIANI COTTURA A GAS - TOP

MOD. _____
COD. _____

DESCRIZIONE/DESCRIPTION/BEZEICHNUNG/DESCRIPTION/DESCRIPCIÓN
DIMENSIONI/DIMENSIONS/ABMESSUNGEN/DIMENSIONS/DIMENSIONES

POTENZA/POWER/LEISTUNG/PUISSANCE/POTENCIA
VOLTAGGIO/VOLTAGE/SPANNUNG/VOLTAGE/VOLTAJE

⚡ kW
kcal/h

PREZZO/PRICE €
PREIS/PRIX/PRECIO €
KG / M³

PC2T-78G
18210853

PIANO COTTURA GAS 2 fuochi (inclusa 1 testata chiusura piano mod. TPA-7)
EN Gas heated boiling unit - 2 burners (included 1 Head end filler strip mod.TPA-7) • **DE** Gas-kochplatte - 2 Kochstellen (inbegriffen 1 Abschluss-Element mod.TPA-7) • **FR** Rechaud gaz - 2 feux vifs (inclus 1 Elément de jonction top mod.TPA-7) • **ES SOBRES DE COCCIÓN GAS - 2 QUEMADORES (INCLUIDA 1 CHAPA DE CIERRE PARA TOP MOD.TPA-7)**
cm. 80x 70,5x 28h



⚡ 17 kW
14.620 kcal/h

2.798,00
73 / 0,35

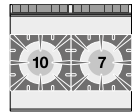

PC3T-712G
18211253

PIANO COTTURA GAS 3 fuochi (inclusa 1 testata chiusura piano mod. TPA-7)
EN Gas heated boiling unit - 3 burners (included 1 Head end filler strip mod.TPA-7) • **DE** Gas-kochplatte - 3 Kochstellen (inbegriffen 1 Abschluss-Element mod.TPA-7) • **FR** Rechaud gaz - 3 feux vifs (inclus 1 Elément de jonction top mod.TPA-7) • **ES SOBRES DE COCCIÓN GAS - 3 QUEMADORES (INCLUIDA 1 CHAPA DE CIERRE PARA TOP MOD.TPA-7)**
cm. 120x 70,5x 28h



⚡ 27 kW
23.220 kcal/h

4.028,00
119 / 0,51

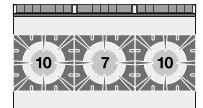

PAT-78G
18210851

"PAELLERO" GAS (inclusa 1 testata chiusura piano mod.TPA-7)
EN "PAELLERO" Gas (included 1 Head end filler strip mod.TPA-7) • **DE** "PAELLERO" Gas (inbegriffen 1 Abschluss-Element mod.TPA-7) • **FR** "PAELLERO" gaz (inclus 1 Elément de jonction top mod.TPA-7) • **ES "PAELLERO" GAS (INCLUIDA 1 CHAPA DE CIERRE PARA TOP MOD.TPA-7)**
cm. 80x 70,5x 28h



⚡ 11,5 kW
9.890 kcal/h

3.338,00
127 / 0,35

TPT-74G
18290450

TUTTA PIASTRA Piastra cm 37x57 (inclusa 1 testata chiusura piano mod. TPA-7)
EN Solid top - Plate 37x57cm (included 1 Head end filler strip mod.TPA-7) • **DE** Kochplatte - Platte 37x57 cm (inbegriffen 1 Abschluss-Element mod.TPA-7) • **FR** Toute plaque - Plaque cm 37x57 (inclus 1 Elément de jonction top mod.TPA-7) • **ES PLACA DE COCCIÓN - PLACA CM 37X57 (INCLUIDA 1 CHAPA DE CIERRE PARA TOP MOD. TPA-7)**
cm. 40x 70,5x 28h



⚡ 7 kW
6.020 kcal/h

2.093,00
60 / 0,18

TPT-78G
18290850

TUTTA PIASTRA Piastra cm 77x57 (inclusa 1 testata chiusura piano mod. TPA-7)
EN Solid top - Plate 77x57cm (included 1 Head end filler strip mod.TPA-7) • **DE** Kochplatte - Platte 77x57 cm (inbegriffen 1 Abschluss-Element mod.TPA-7) • **FR** Toute plaque - Plaque cm. 77x57 (inclus 1 Elément de jonction top mod.TPA-7) • **ES PLACA DE COCCIÓN - PLACA CM 77X57 (INCLUIDA 1 CHAPA DE CIERRE PARA TOP MOD. TPA-7)**
cm. 80x 70,5x 28h



⚡ 12 kW
10.320 kcal/h

2.885,00
149 / 0,35

TPT-78ET
18120830

TUTTA PIASTRA Piastra cm. 70x50 - 4 zone (inclusa 1 testata chiusura piano mod.TPA-7)
EN Solid top - Plate cm. 70x50- 4 zones (included 1 Head end filler strip mod.TPA-7) • **DE** Kochplatten - Platte cm. 70x50 - 4 zonen (inbegriffen 1 Abschluss-Element mod.TPA-7) • **FR** Toute plaque - Plaque cm. 70x50 - 4 zones (inclus 1 Elément de jonction top mod.TPA-7) • **ES PLACA DE COCCIÓN - PLACA CM. 70X50 - 4 ZONAS (INCLUIDA 1 CHAPA DE CIERRE PARA TOP MOD.TPA-7)**
cm. 80x 70,5x 28h



⚡ 10 kW
400V~3N
50/60 Hz

3.574,00
116 / 0,35

TP2T-78GP
18300850

TUTTA PIASTRA + 2 FUOCHI - Piastra cm 37x57 (inclusa 1 testata chiusura piano mod.TPA-7)
EN Solid top + 2 burners - Plate 37x57 (included 1 Head end filler strip mod.TPA-7) • **DE** Kochplatte + 2 Gaskochstellen - Platte 37x57 (inbegriffen 1 Abschluss-Element mod.TPA-7) • **FR** Toute plaque + 2 brûleurs - Plaque cm 37x57 (inclus 1 Elément de jonction top mod.TPA-7) • **ES PLACA DE COCCIÓN + 2 FUEGOS - PLACA CM 37X57 (INCLUIDA 1 CHAPA DE CIERRE PARA TOP MOD.TPA-7)**
cm. 80x 70,5x 28h



⚡ 20 kW
17.200 kcal/h

3.336,00
158 / 0,35

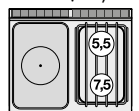

TUTTAPIASTRA A GAS - TOP

MOD. _____ DESCRIZIONE/DESCRIPTION/BEZEICHNUNG/DESCRIPTION/DESCRIPCIÓN POTENZA/POWER/LEISTUNG/PUISSANCE/POTENCIA ⚡ kW PREZZO/PRICE €
 COD. _____ DIMENSIONI/DIMENSIONS/ABMESSUNGEN/DIMENSIONS/DIMENSIONES VOLTAGGIO/VOLTAGE/SPANNUNG/VOLTAGE/VOLTAJE kcal/h kw V~ Hz PREIS/PRIX/PRECIO KG / M³

TP2T-712GP TUTTA PIASTRA + 2 FUOCHI Piastra cm. 77x57 (inclusa 1 testata chiusura piano mod.TPA-7)
 18291250 **EN** Solid top + 2 burners - Plate 77x57 (included 1 Head end filler strip mod.TPA-7) • **DE** Kochplatte + 2 Gaskochstellen - Platte 77x57 (inbegriffen 1 Abschluss-Element mod.TPA-7) • **FR** Toute plaque + 2 brûleurs - Plaque cm. 77x57 (inclus 1 Élément de jonction top mod.TPA-7)
 • **ES PLACA DE COCCIÓN + 2 FUEGOS - PLACA CM. 77X57 (INCLUIDA 1 CHAPA DE CIERRE PARA TOP MOD.TPA-7)**
cm. 120x 70,5x 28h



⚡ 25 kW 4.213,00
 21.500 kcal/h 175 / 0,51

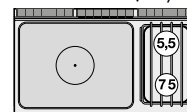

TP4T-712GP TUTTA PIASTRA + 4 FUOCHI Piastra cm. 37x57 (inclusa 1 testata chiusura piano mod.TPA-7)
 18301250 **EN** Solid top + 4 burners - Plate 37x57 (included 1 Head end filler strip mod.TPA-7) • **DE** Kochplatte + 4 Gaskochstellen - Platte 37x57 (inbegriffen 1 Abschluss-Element mod.TPA-7) • **FR** Toute plaque + 4 brûleurs - Plaque cm. 37x57 (inclus 1 Élément de jonction top mod.TPA-7)
 • **ES PLACA DE COCCIÓN + 4 FUEGOS - PLACA CM. 37X57 (INCLUIDA 1 CHAPA DE CIERRE PARA TOP MOD.TPA-7)**
cm. 120x 70,5x 28h



⚡ 29 kW 4.564,00
 24.940 kcal/h 202 / 0,51

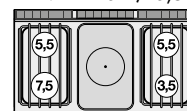

BMT-74EM BAGNOMARIA MONOFASE Vasca per GN 1/1 h.15 (inclusa 1 testata chiusura piano mod.TPA-7)
 18050410 **EN** Bain marie singlephase - Bowl for GN 1/1 h.15 (included 1 Head end filler strip mod.TPA-7) • **DE** Wasserbäder einphasig - Becken GN 1/1 h.15 (inbegriffen 1 Abschluss-Element mod.TPA-7) • **FR** Bain marie monophasé - Cuve GN 1/1 h.15 (inclus 1 Élément de jonction top mod.TPA-7)
 • **ES BAÑO DE MARÍA MONOFÁSICO - CUBA PARA GN 1/1 15H (INCLUIDA 1 CHAPA DE CIERRE PARA TOP MOD.TPA-7)**
cm. 40x 70,5x 28h



⚡ 2,1 kW 1.443,00
 230V~ 35 / 0,18
 50/60 Hz

BMT-78ET BAGNOMARIA TRIFASE Vasca per GN 2/1 15h (inclusa 1 testata chiusura piano mod.TPA-7)
 18050830 **EN** Bain marie threephase - Bowl for GN 2/1 15h (included 1 Head end filler strip mod.TPA-7) • **DE** Wasserbäder dreiphasig - Becken GN 2/1 15h (inbegriffen 1 Abschluss-Element mod.TPA-7) • **FR** Bain marie triphase - Cuve GN 2/1 15h (inclus 1 Élément de jonction top mod.TPA-7)
 • **ES BAÑO DE MARÍA TRIFÁSICO - CUBA PARA GN 2/1 15H (INCLUIDA 1 CHAPA DE CIERRE PARA TOP MOD.TPA-7)**
cm. 80x 70,5x 28h



⚡ 4,2 kW 1.955,00
 400V~2N 54 / 0,35
 230V~3
 50/60 Hz

BMT-74G BAGNOMARIA GAS Vasca per GN 1/1 h.15 (inclusa 1 testata chiusura piano mod.TPA-7)
 18220450 **EN** Gas bain-marie - Bowl for GN 1/1 h.15 (included 1 Head end filler strip mod.TPA-7) • **DE** Gas Wasserbad - Becken GN 1/1 h.15 (inbegriffen 1 Abschluss-Element mod.TPA-7) • **FR** Bain-marie gaz - Cuve pour GN 1/1 h.15 (inclus 1 Élément de jonction top mod.TPA-7)
 • **ES BAÑO DE MARÍA GAS - CUBA PARA GN 1/1 15H (INCLUIDA 1 CHAPA DE CIERRE PARA TOP MOD.TPA-7)**
cm. 40x 70,5x 28h



⚡ 3,5 kW 1.832,00
 3.010 kcal/h 43 / 0,18

BMT-78G BAGNOMARIA GAS Vasca per GN 2/1 h.15 (inclusa 1 testata chiusura piano mod.TPA-7)
 18220850 **EN** Gas bain-marie - Bowl for GN 2/1 h.15 (included 1 Head end filler strip mod.TPA-7) • **DE** Gas Wasserbad - Becken GN 2/1 h.15 (inbegriffen 1 Abschluss-Element mod.TPA-7) • **FR** Bain-marie gaz - Cuve pour GN 2/1 h.15 (inclus 1 Élément de jonction top mod.TPA-7)
 • **ES BAÑO DE MARÍA GAS - CUBA PARA GN 2/1 15H (INCLUIDA 1 CHAPA DE CIERRE PARA TOP MOD.TPA-7)**
cm. 80x 70,5x 28h



⚡ 6,5 kW 2.512,00
 5.590 kcal/h 61 / 0,35

CONTENITORE CALDO INFRAROSSO - TOP

MOD. _____
COD. _____

DESCRIZIONE/DESCRIPTION/BEZEICHNUNG/DESCRIPTION/DESCRIPCIÓN
DIMENSIONI/DIMENSIONS/ABMESSUNGEN/DIMENSIONS/DIMENSIONES

POTENZA/POWER/LEISTUNG/PUISSANCE/POTENCIA
VOLTAGGIO/VOLTAGE/SPANNUNG/VOLTAGE/VOLTAJE

⚡ kW _____
kcal/h _____
230V~
V~
Hz

PREZZO/PRICE €
PREIS/PRIX/PRECIO €
KG / M³

BST-74EM
18040410

CONTENITORE CALDO CON INFRAROSSO MONOFASE Vasca cm. 30,5x51x16,5h con falsofondo forato (inclusa 1 testata chiusura piano mod.TPA-7)
EN Fry dump singlephase with infra-red heater. Bowl cm. 30,5x51x16,5h with perforated double bottom (included 1 Head end filler strip mod. TPA-7) • **DE** Frittenwanne Einphasig mit Infrarot-strahler. Becke cm. 30,5x51x16,5h mit gelochtem Bodenrost (inbegriffen 1 Abschluss-Element mod.TPA-7) • **FR** Silo a frites monophasé avec infrarouge. Cuve cm 30,5x51x16,5h avec double-fond perforé. (inclus 1 Élément de jonction top mod.TPA-7) • **ES CONTENEDOR CALIENTE POR INFRARROJO MONOFÁSICO. CUBA CM. 30,5X51X16,5H CON FALSO FONDO AGUJERADO (INCLUIDA 1 CHAPA DE CIERRE PARA TOP MOD.TPA-7)**
cm. 40x 70,5x 28h



⚡ 1,47 kW _____ **1.770,00**
230V~ _____ 36 / 0,21
50/60 Hz

CPT-74ET
18100430

CUOCIPASTA TRIFASE LT. 17 Vasca cm. 31x33,5x22h. Rubinetto scarico (CESTI ESCLUSI) (inclusa 1 testata chiusura piano mod.TPA-7)
EN Pasta cooker threephase 17 lts. Tank cm. 31x33,5x22h. Drain-tap (BASKETS EXCLUDED) (included 1 Head end filler strip mod.TPA-7) • **DE** Nudelkocher dreiphasig lt.17 Becken cm. 31x33,5x22h. Ablasshahn (KORB AUSGESCHLOSSEN) (inbegriffen 1 Abschluss-Element mod. TPA-7) • **FR** Cuiseur à pates triphase lt.17 Cuve cm. 31x33,5x22h. Robinet de vidange (PANIERS EXCLUS) (inclus 1 Élément de jonction top mod.TPA-7) • **ES CUECE PASTA TRIFÁSICO LT.17 CUBA CM. 31X33,5X22H. GRIFO DESCARGA (CESTAS EXCLUIDAS) (INCLUIDA 1 CHAPA DE CIERRE PARA TOP MOD.TPA-7)**
cm. 40x 70,5x 28h



⚡ 4,1 kW _____ **2.048,00**
400V~3N _____ 35 / 0,18
230V~
50/60 Hz

COMBINAZIONI

- Combinations / • Zusammenstellungen
- Combinaisons / • Combinación múltiple



CPT-76ET
18100630

CUOCIPASTA TRIFASE LT. 25 Vasca cm. 51x31x22h. Rubinetto scarico (CESTI ESCLUSI) (inclusa 1 testata chiusura piano mod.TPA-7)
EN Pasta cooker threephase 25 lts. Tank cm. 51x31x22h. Drain-tap (BASKETS EXCLUDED) (included 1 Head end filler strip mod.TPA-7)
• **DE** Nudelkocher dreiphasig lt.25 Becken cm. 51x31x22h. Ablasshahn (KORB AUSGESCHLOSSEN) (inbegriffen 1 Abschluss-Element mod.TPA-7)
• **FR** Cuiseur à pates triphase lt.25 Cuve cm. 51x31x22h. Robinet de vidange (PANIERS EXCLUS) (inclus 1 Élément de jonction top mod.TPA-7)
• **ES CUECE PASTA TRIFÁSICO LT.25 CUBA CM. 51X31X22H. GRIFO DESCARGA (CESTAS EXCLUIDAS) (INCLUIDA 1 CHAPA DE CIERRE PARA TOP MOD.TPA-7)**
cm. 60x 70,5x 28h



⚡ 6,25 kW _____ **2.339,00**
400V~3N _____ 45 / 0,26
50/60 Hz

COMBINAZIONI

- Combinations / • Zusammenstellungen
- Combinaisons / • Combinación múltiple



CUOCIPASTA A GAS - TOP

MOD. _____
COD. _____

DESCRIZIONE/DESCRIPTION/BEZEICHNUNG/DESCRIPTION/DESCRIPCIÓN
DIMENSIONI/DIMENSIONS/ABMESSUNGEN/DIMENSIONS/DIMENSIONES

POTENZA/POWER/LEISTUNG/PUISSANCE/POTENCIA
VOLTAGGIO/VOLTAGE/SPANNUNG/VOLTAGE/VOLTAJE

⚡ kW
kcal/h

⚡ kw
V~
Hz

PREZZO/PRICE €
PREIS/PRIX/PRECIO €
KG / M³

CPT-74G
18270450

CUOCIPASTA A GAS CAPACITA' LT. 13 Vasca cm. 31x33,5x18h. Rubinetto scarico (CESTI ESCLUSI) (inclusa 1 testata chiusura piano mod. TPA-7)

EN Gas pasta cookers Tank capacity 13 lts. Tank cm. 31x33,5x18h. Drain-tap (BASKETS EXCLUDED) (included 1 Head end filler strip mod.TPA-7) • **DE** Gas -Nudelkocher Beckeninhalte lt.13 Becken cm. 31x33,5x18h. Ablasshahn (KORB AUSGESCHLOSSEN) (inbegriffen 1 Abschluss-Element mod.TPA-7) • **FR** Cuiseur à pâtes gaz Cuve lt.13 Cuve cm. 31x33,5x18h. Robinet de vidange (PANIERS EXCLUS) (inclus 1 Élément de jonction top mod.TPA-7) • **ES CUECE PASTA GAS CUBA 13 LT. CUBA CM. 31X33,5X18H. GRIFO DESCARGA (CESTAS EXCLUIDAS) (INCLUIDA 1 CHAPA DE CIERRE PARA TOP MOD. TPA-7)**

cm. 40x 70,5x 28h



⚡ 6 kW
5.160 kcal/h

2.223,00
38 / 0,18

COMBINAZIONI

- Combinations / • Zusammenstellungen
- Combinaisons / • Combinación múltiple

1/1	1/2	1/2	1/4	1/4	1/6	1/6	1/2	1/4
			1/4	1/4	1/6	1/6		1/4
			1/4	1/4	1/6	1/6		1/4

CPT-76G
18270650

CUOCIPASTA A GAS CAPACITA' LT. 19 Vasca cm. 51x31x18h. Rubinetto scarico (CESTI ESCLUSI) (inclusa 1 testata chiusura piano mod.TPA-7)

EN Gas pasta cookers Tank capacity 19 lts. Tank cm. 51x31x18h. Drain-tap (BASKETS EXCLUDED) (included 1 Head end filler strip mod.TPA-7) • **DE** Gas -Nudelkocher Beckeninhalte lt. 19 Becken cm. 51x31x18h. Ablasshahn (KORB AUSGESCHLOSSEN) (inbegriffen 1 Abschluss-Element mod.TPA-7) • **FR** Cuiseur à pâtes gaz Cuve lt.19 Cuve cm. 51x31x18h. Robinet de vidange (PANIERS EXCLUS) (inclus 1 Élément de jonction top mod.TPA-7) • **ES CUECE PASTA GAS CUBA 19 LT. CUBA CM. 51X31X18H. GRIFO DESCARGA (CESTAS EXCLUIDAS) (INCLUIDA 1 CHAPA DE CIERRE PARA TOP MOD.TPA-7)**

cm. 60x 70,5x 28h



⚡ 9 kW
7.740 kcal/h

2.625,00
49 / 0,26

COMBINAZIONI

- Combinations / • Zusammenstellungen
- Combinaisons / • Combinación múltiple

1/1	1/3	1/3	1/3	1/4	1/4	1/4	1/4
-----	-----	-----	-----	-----	-----	-----	-----

FTLT-74ET
18060431

Fry-top elettrico liscio, piastra cm.36x51 (inclusa 1 testata chiusura piano mod.TPA-7)

EN Electric Fry-top smooth griddle, plate cm.36x51 (included 1 Head end filler strip mod.TPA-7) • **DE** Griddleplatte elektrische glatt, platte cm.36x51 (inbegriffen 1 Abschluss-Element mod.TPA-7) • **FR** Plaque électriques lisse, plaque cm.36x51 (inclus 1 Élément de jonction top mod.TPA-7) • **ES FRY-TOP ELÉCTRICO LISO, PLANCHA CM.36X51 (INCLUIDA 1 CHAPA DE CIERRE PARA TOP MOD.TPA-7)**

cm. 40x 70,5x 28h



⚡ 5,55 kW
400V~3N
230V~3
50/60 Hz

1.988,00
58 / 0,18

FTLT-74ETS
18060434

Fry-top elettrico liscio cromato SUPERCHROME (Moca Approved), piastra cm.36x51 (inclusa 1 testata chiusura piano mod.TPA-7)

EN Electric Fry-top smooth chromed griddle SUPERCHROME (Moca Approved), plate cm.36x51 (included 1 Head end filler strip mod.TPA-7) • **DE** Griddleplatte elektrische glatt hartverchromt SUPERCHROME (Moca Approved), platte cm.36x51 (inbegriffen 1 Abschluss-Element mod.TPA-7) • **FR** Plaque électriques lisse chromée SUPERCHROME (Moca Approved), plaque cm.36x51 (inclus 1 Élément de jonction top mod.TPA-7) • **ES FRY-TOP ELÉCTRICO LISO CROMADO SUPERCHROME (MOCA APPROVED), PLANCHA CM.36X51 (INCLUIDA 1 CHAPA DE CIERRE PARA TOP MOD.TPA-7)**

cm. 40x 70,5x 28h

⚡ 5,55 kW
400V~3N
230V~3
50/60 Hz

2.334,00
58 / 0,18

FRY-TOP ELETTRICI - TOP

MOD. _____
COD. _____

DESCRIZIONE/DESCRIPTION/BEZEICHNUNG/DESCRIPTION/DESCRIPCIÓN
DIMENSIONI/DIMENSIONS/ABMESSUNGEN/DIMENSIONS/DIMENSIONES

POTENZA/POWER/LEISTUNG/PUISSANCE/POTENCIA
VOLTAGGIO/VOLTAGE/SPANNUNG/VOLTAGE/VOLTAJE

⚡ kW kcal/h
V~ Hz

PREZZO/PRICE €
PREIS/PRIX/PRECIO €
KG / M³

FTLT-74ETSS Fry-top elettrico liscio CROMO LUCIDO, piastra cm.36x51 (inclusa 1 testata chiusura piano mod.TPA-7)
EN Electric Fry-top smooth POLISHED CHROME, plate cm.36x51 (included 1 Head end filler strip mod.TPA-7) • **DE** Griddleplatte elektrische glatt POLIERTEM CHROM, platte cm.36x51 (inbegriffen 1 Abschluss-Element mod.TPA-7) • **FR** Plaque électriques lisse CHROME POLI, plaque cm.36x51 (inclus 1 Elément de jonction top mod.TPA-7) • **ES FRY-TOP ELÉCTRICO LISO CROMO PULIDO, PLANCHA CM.36X51 (INCLUIDA 1 CHAPA DE CIERRE PARA TOP MOD. TPA-7)**
cm. 40x 70,5x 28h



⚡ 5,55 kW **2.334,00**
400V~3N 58 / 0,18
230V~3
50/60 Hz

FTRT-74ET Fry-top elettrico rigato, piastra cm.36x51 (inclusa 1 testata chiusura piano mod.TPA-7)
EN Electric Fry-top grooved griddle, plate cm.36x51 (included 1 Head end filler strip mod.TPA-7) • **DE** Griddleplatte elektrische gerillt, platte cm.36x51 (inbegriffen 1 Abschluss-Element mod.TPA-7) • **FR** Plaque électriques nervurée, plaque cm.36x51 (inclus 1 Elément de jonction top mod.TPA-7) • **ES FRY-TOP ELÉCTRICO ESTRIADO, PLANCHA CM.36X51 (INCLUIDA 1 CHAPA DE CIERRE PARA TOP MOD. TPA-7)**
cm. 40x 70,5x 28h



⚡ 5,55 kW **2.147,00**
400V~3N 58 / 0,18
230V~3
50/60 Hz

FTRT-74ETS Fry-top elettrico rigato cromato SUPERCHROME (Moca Approved), piastra cm.36x51 (inclusa 1 testata chiusura piano mod.TPA-7)
EN Electric Fry-top grooved chromed griddle SUPERCHROME (Moca Approved), plate cm.36x51 (included 1 Head end filler strip mod.TPA-7) • **DE** Griddleplatte elektrische gerillt hartverchromt SUPERCHROME (Moca Approved), platte cm.36x51 (inbegriffen 1 Abschluss-Element mod.TPA-7) • **FR** Plaque électriques nervurée chromée SUPERCHROME (Moca Approved), plaque cm.36x51 (inclus 1 Elément de jonction top mod.TPA-7) • **ES FRY-TOP ELÉCTRICO ESTRIADO CROMADO SUPERCHROME (MOCA APPROVED), PLANCHA CM.36X51 (INCLUIDA 1 CHAPA DE CIERRE PARA TOP MOD.TPA-7)**
cm. 40x 70,5x 28h



⚡ 5,55 kW **2.486,00**
400V~3N 58 / 0,18
230V~3
50/60 Hz

FTLT-76ET Fry-top elettrico liscio, piastra cm.56x51 (inclusa 1 testata chiusura piano mod.TPA-7)
EN Electric Fry-top smooth griddle, plate cm.56x51 (included 1 Head end filler strip mod.TPA-7) • **DE** Griddleplatte elektrische glatt, platte cm.56x51 (inbegriffen 1 Abschluss-Element mod.TPA-7) • **FR** Plaque électriques lisse, plaque cm.56x51 (inclus 1 Elément de jonction top mod.TPA-7) • **ES FRY-TOP ELÉCTRICO LISO, PLANCHA CM.56X51 (INCLUIDA 1 CHAPA DE CIERRE PARA TOP MOD.TPA-7)**
cm. 60x 70,5x 28h



⚡ 7,4 kW **2.274,00**
400V~3N 67 / 0,26
50/60 Hz

FTLT-76ETS Fry-top elettrico liscio cromato SUPERCHROME (Moca Approved), piastra cm.56x51 (inclusa 1 testata chiusura piano mod.TPA-7)
EN Electric Fry-top smooth chromed griddle SUPERCHROME (Moca Approved), plate cm.56x51 (included 1 Head end filler strip mod.TPA-7) • **DE** Griddleplatte elektrische glatt hartverchromt SUPERCHROME (Moca Approved), platte cm.56x51 (inbegriffen 1 Abschluss-Element mod.TPA-7) • **FR** Plaque électriques lisse chromée SUPERCHROME (Moca Approved), plaque cm.56x51 (inclus 1 Elément de jonction top mod.TPA-7) • **ES FRY-TOP ELÉCTRICO LISO CROMADO SUPERCHROME (MOCA APPROVED), PLANCHA CM.56X51 (INCLUIDA 1 CHAPA DE CIERRE PARA TOP MOD.TPA-7)**
cm. 60x 70,5x 28h



⚡ 7,4 kW **2.848,00**
400V~3N 67 / 0,26
50/60 Hz

FTLT-76ETSS Fry-top elettrico liscio CROMO LUCIDO, piastra cm.56x51 (inclusa 1 testata chiusura piano mod.TPA-7)
EN Electric Fry-top smooth POLISHED CHROME, plate cm.56x51 (included 1 Head end filler strip mod.TPA-7) • **DE** Griddleplatte elektrische glatt POLIERTEM CHROM, platte cm.56x51 (inbegriffen 1 Abschluss-Element mod.TPA-7) • **FR** Plaque électriques lisse CHROME POLI, plaque cm.56x51 (inclus 1 Elément de jonction top mod.TPA-7) • **ES FRY-TOP ELÉCTRICO LISO CROMO PULIDO, PLANCHA CM.56X51 (INCLUIDA 1 CHAPA DE CIERRE PARA TOP MOD. TPA-7)**
cm. 60x 70,5x 28h



⚡ 7,4 kW **2.848,00**
400V~3N 67 / 0,26
50/60 Hz

FRY-TOP ELETTRICI - TOP

MOD. _____ DESCRIZIONE/DESCRIPTION/BEZEICHNUNG/DESCRIPTION/DESCRIPCIÓN POTENZA/POWER/LEISTUNG/PUISSANCE/POTENCIA ⚡kW ⚡kW PREZZO/PRICE €
 COD. _____ DIMENSIONI/DIMENSIONS/ABMESSUNGEN/DIMENSIONS/DIMENSIONES VOLTAGGIO/VOLTAGE/SPANNUNG/VOLTAGE/VOLTAJE kcal/h V~ Hz kg/m² PREIS/PRIX/PRECIO €
 KG / M³

FTLRT-76ET Fry-top elettrico 1/2 rigato + 1/2 liscio, piastra cm.56x51 (inclusa 1 testata chiusura piano mod.TPA-7)
 18060632 **EN** Electric Fry-top 1/2 grooved + 1/2 smooth, plate cm.56x51 (included 1 Head end filler strip mod.TPA-7) • **DE** Griddleplatte elektrische 1/2 gerillt + 1/2 glatt, platte cm.56x51 (inbegriffen 1 Abschluss-Element mod.TPA-7) • **FR** Plaque électriques 1/2 nervurée + 1/2 lisse, plaque cm.56x51 (inclus 1 Élément de jonction top mod.TPA-7) • **ES FRY-TOP ELÉCTRICO 1/2 ESTRIADO + 1/2 LISO, PLANCHA CM.56X51 (INCLUIDA 1 CHAPA DE CIERRE PARA TOP MOD.TPA-7)**
cm. 60x 70,5x 28h



⚡ 7,4 kW **2.453,00**
 400V~3N 67 / 0,26
 50/60 Hz

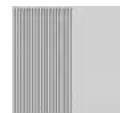

FTLRT-76ETS Fry-top elettrico 1/2 rigato + 1/2 liscio cromato SUPERCHROME (Moca Approved), piastra cm.56x51 (inclusa 1 testata chiusura piano mod.TPA-7)
 18060635 **EN** Electric Fry-top 1/2 grooved + 1/2 smooth chromed griddle SUPERCHROME (Moca Approved), plate cm.56x51 (included 1 Head end filler strip mod.TPA-7) • **DE** Griddleplatte elektrische 1/2 gerillt + 1/2 glatt hartverchromt SUPERCHROME (Moca Approved), platte cm.56x51 (inbegriffen 1 Abschluss-Element mod.TPA-7) • **FR** Plaque électriques 1/2 nervurée + 1/2 lisse chromée SUPERCHROME (Moca Approved), plaque cm.56x51 (inclus 1 Élément de jonction top mod.TPA-7) • **ES FRY-TOP ELÉCTRICO 1/2 ESTRIADO + 1/2 LISO CROMADO SUPERCHROME (MOCA APPROVED), PLANCHA CM.56X51 (INCLUIDA 1 CHAPA DE CIERRE PARA TOP MOD.TPA-7)**
cm. 60x 70,5x 28h



⚡ 7,4 kW **3.020,00**
 400V~3N 67 / 0,26
 50/60 Hz

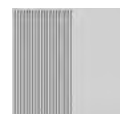

FTRT-76ET Fry-top elettrico rigato, piastra cm.56x51 (inclusa 1 testata chiusura piano mod.TPA-7)
 18060633 **EN** Electric Fry-top grooved griddle, plate cm.56x51 (included 1 Head end filler strip mod.TPA-7) • **DE** Griddleplatte elektrische gerillt, platte cm.56x51 (inbegriffen 1 Abschluss-Element mod.TPA-7) • **FR** Plaque électriques nervurée, plaque cm.56x51 (inclus 1 Élément de jonction top mod.TPA-7) • **ES FRY-TOP ELÉCTRICO ESTRIADO, PLANCHA CM.56X51 (INCLUIDA 1 CHAPA DE CIERRE PARA TOP MOD.TPA-7)**
cm. 60x 70,5x 28h

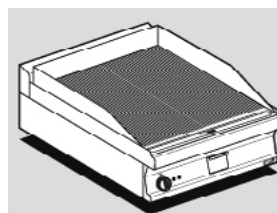

⚡ 7,4 kW **2.629,00**
 400V~3N 67 / 0,26
 50/60 Hz

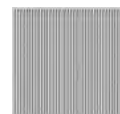

FTRT-76ETS Fry-top elettrico rigato cromato SUPERCHROME (Moca Approved), piastra cm.56x51 (inclusa 1 testata chiusura piano mod.TPA-7)
 18060636 **EN** Electric Fry-top grooved chromed griddle SUPERCHROME (Moca Approved), plate cm.56x51 (included 1 Head end filler strip mod.TPA-7) • **DE** Griddleplatte elektrische gerillt hartverchromt SUPERCHROME (Moca Approved), platte cm.56x51 (inbegriffen 1 Abschluss-Element mod.TPA-7) • **FR** Plaque électriques nervurée chromée SUPERCHROME (Moca Approved), plaque cm.56x51 (inclus 1 Élément de jonction top mod.TPA-7) • **ES FRY-TOP ELÉCTRICO ESTRIADO CROMADO SUPERCHROME (MOCA APPROVED), PLANCHA CM.56X51 (INCLUIDA 1 CHAPA DE CIERRE PARA TOP MOD.TPA-7)**
cm. 60x 70,5x 28h

⚡ 7,4 kW **3.200,00**
 400V~3N 67 / 0,26
 50/60 Hz

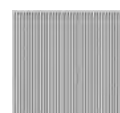

FTLT-78ET Fry-top elettrico liscio, piastra cm.76x51 - 2 zone di cottura (inclusa 1 testata chiusura piano mod.TPA-7)
 18060831 **EN** Electric Fry-top smooth griddle, plate cm.76x51 - 2 cooking areas (included 1 Head end filler strip mod.TPA-7) • **DE** Griddleplatte elektrische glatt, platte cm.76x51 - 2 Heizzonen (inbegriffen 1 Abschluss-Element mod.TPA-7) • **FR** Plaque électriques lisse, plaque cm.76x51 - 2 zones de cuisson (inclus 1 Élément de jonction top mod.TPA-7) • **ES FRY-TOP ELÉCTRICO LISO, PLANCHA CM.76X51 - 2 ZONAS DE COCCIÓN (INCLUIDA 1 CHAPA DE CIERRE PARA TOP MOD.TPA-7)**
cm. 80x 70,5x 28h



⚡ 11,1 kW **2.955,00**
 400V~3N 103 / 0,35
 230V~3
 50/60 Hz



FRY-TOP ELETTRICI - TOP

MOD. _____
COD. _____

DESCRIZIONE/DESCRIPTION/BEZEICHNUNG/DESCRIPTION/DESCRIPCIÓN
DIMENSIONI/DIMENSIONS/ABMESSUNGEN/DIMENSIONS/DIMENSIONES

POTENZA/POWER/LEISTUNG/PUISSANCE/POTENCIA
VOLTAGGIO/VOLTAGE/SPANNUNG/VOLTAGE/VOLTAJE

⚡ kW kcal/h
⚡ kW V~ Hz

PREZZO/PRICE €
PREIS/PRIX/PRECIO €
KG / M³

FTLT-78ETS Fry-top elettrico liscio cromato SUPERCHROME (Moca Approved), piastra cm.76x51 - 2 zone di cottura (inclusa 1 testata chiusura piano mod.TPA-7)
EN Electric Fry-top smooth chromed griddle SUPERCHROME (Moca Approved), plate cm.76x51 - 2 cooking areas (included 1 Head end filler strip mod.TPA-7) • **DE** Griddleplatte elektrische glatt hartverchromt SUPERCHROME (Moca Approved), platte cm.76x51 - 2 Heizzonen (inbegriffen 1 Abschluss-Element mod.TPA-7) • **FR** Plaque électriques lisse chromée SUPERCHROME (Moca Approved), plaque cm.76x51 - 2 zones de cuisson (inclus 1 Élément de jonction top mod.TPA-7) • **ES FRY-TOP ELÉCTRICO LISO CROMADO SUPERCHROME (MOCA APPROVED), PLANCHA CM.76X51 - 2 ZONAS DE COCCIÓN (INCLUIDA 1 CHAPA DE CIERRE PARA TOP MOD.TPA-7)**
cm. 80x 70,5x 28h



⚡ 11,1 kW **3.686,00**
400V~3N 103 / 0,35
230V~3
50/60 Hz



FTLT-78ETSS Fry-top elettrico liscio CROMO LUCIDO, piastra cm.76x51 - 2 zone di cottura (inclusa 1 testata chiusura piano mod.TPA-7)
EN Electric Fry-top smooth POLISHED CHROME, plate cm.76x51 - 2 cooking areas (included 1 Head end filler strip mod.TPA-7) • **DE** Griddleplatte elektrische glatt POLIERTEM CHROM, platte cm.76x51 - 2 Heizzonen (inbegriffen 1 Abschluss-Element mod.TPA-7) • **FR** Plaque électriques lisse CHROME POLI, plaque cm.76x51 - 2 zones de cuisson (inclus 1 Élément de jonction top mod.TPA-7) • **ES FRY-TOP ELÉCTRICO LISO CROMO PULIDO, PLANCHA CM.76X51 - 2 ZONAS DE COCCIÓN (INCLUIDA 1 CHAPA DE CIERRE PARA TOP MOD.TPA-7)**
cm. 80x 70,5x 28h

⚡ 11,1 kW **3.686,00**
400V~3N 103 / 0,35
230V~3
50/60 Hz



FTLRT-78ET Fry-top elettrico 1/2 rigato + 1/2 liscio, piastra cm.76x51 - 2 zone di cottura (inclusa 1 testata chiusura piano mod.TPA-7)
EN Electric Fry-top 1/2 grooved + 1/2 smooth, plate cm.76x51 - 2 cooking areas (included 1 Head end filler strip mod.TPA-7) • **DE** Griddleplatte elektrische 1/2 gerillt + 1/2 glatt, platte cm.76x51 - 2 Heizzonen (inbegriffen 1 Abschluss-Element mod.TPA-7) • **FR** Plaque électriques 1/2 nervurée + 1/2 lisse, plaque cm.76x51 - 2 zones de cuisson (inclus 1 Élément de jonction top mod.TPA-7) • **ES FRY-TOP ELÉCTRICO 1/2 ESTRIADO + 1/2 LISO, PLANCHA CM.76X51 - 2 ZONAS DE COCCIÓN (INCLUIDA 1 CHAPA DE CIERRE PARA TOP MOD.TPA-7)**
cm. 80x 70,5x 28h



⚡ 11,1 kW **3.188,00**
400V~3N 103 / 0,35
230V~3
50/60 Hz



FTLRT-78ETS Fry-top elettrico 1/2 rigato + 1/2 liscio cromato SUPERCHROME (Moca Approved), piastra cm.76x51 - 2 zone di cottura (inclusa 1 testata chiusura piano mod.TPA-7)
EN Electric Fry-top 1/2 grooved + 1/2 smooth chromed griddle SUPERCHROME (Moca Approved), plate cm.76x51 - 2 cooking areas (included 1 Head end filler strip mod.TPA-7) • **DE** Griddleplatte elektrische 1/2 gerillt + 1/2 glatt hartverchromt SUPERCHROME (Moca Approved), platte cm.76x51 - 2 Heizzonen (inbegriffen 1 Abschluss-Element mod.TPA-7) • **FR** Plaque électriques 1/2 nervurée + 1/2 lisse chromée SUPERCHROME (Moca Approved), plaque cm.76x51 - 2 zones de cuisson (inclus 1 Élément de jonction top mod.TPA-7) • **ES FRY-TOP ELÉCTRICO 1/2 ESTRIADO + 1/2 LISO CROMADO SUPERCHROME (MOCA APPROVED), PLANCHA CM.76X51 - 2 ZONAS DE COCCIÓN (INCLUIDA 1 CHAPA DE CIERRE PARA TOP MOD.TPA-7)**
cm. 80x 70,5x 28h

⚡ 11,1 kW **3.910,00**
400V~3N 103 / 0,35
230V~3
50/60 Hz



FTRT-78ET Fry-top elettrico rigato, piastra cm.76x51 - 2 zone di cottura (inclusa 1 testata chiusura piano mod.TPA-7)
EN Electric Fry-top grooved griddle, plate cm.76x51 - 2 cooking areas (included 1 Head end filler strip mod.TPA-7) • **DE** Griddleplatte elektrische gerillt, platte cm.76x51 - 2 Heizzonen (inbegriffen 1 Abschluss-Element mod.TPA-7) • **FR** Plaque électriques nervurée, plaque cm.76x51 - 2 zones de cuisson (inclus 1 Élément de jonction top mod.TPA-7) • **ES FRY-TOP ELÉCTRICO ESTRIADO, PLANCHA CM.76X51 - 2 ZONAS DE COCCIÓN (INCLUIDA 1 CHAPA DE CIERRE PARA TOP MOD.TPA-7)**
cm. 80x 70,5x 28h



⚡ 11,1 kW **3.361,00**
400V~3N 103 / 0,35
230V~3
50/60 Hz



FRY-TOP ELETTRICI - TOP

MOD. _____
COD. _____

DESCRIZIONE/DESCRIPTION/BEZEICHNUNG/DESCRIPTION/DESCRIPCIÓN
DIMENSIONI/DIMENSIONS/ABMESSUNGEN/DIMENSIONS/DIMENSIONES

POTENZA/POWER/LEISTUNG/PUISSANCE/POTENCIA
VOLTAGGIO/VOLTAGE/SPANNUNG/VOLTAGE/VOLTAJE

⚡ kW kcal/h
⚡ kw V~ Hz

PREZZO/PRICE €
PREIS/PRIX/PRECIO €
KG / M³

FTRT-78ETS Fry-top elettrico rigato cromato SUPERCHROME (Moca Approved), piastra cm.76x51 - 2 zone di cottura (inclusa 1 testata chiusura piano mod.TPA-7)
EN Electric Fry-top grooved chromed griddle SUPERCHROME (Moca Approved), plate cm.76x51 - 2 cooking areas (included 1 Head end filler strip mod.TPA-7) • **DE** Griddleplatte elektrische gerillt hartverchromt SUPERCHROME (Moca Approved), platte cm.76x51 - 2 Heizzonen (inbegriffen 1 Abschluss-Element mod.TPA-7) • **FR** Plaque électriques nervurée chromée SUPERCHROME (Moca Approved), plaque cm.76x51 - 2 zones de cuisson (inclus 1 Élément de jonction top mod.TPA-7) • **ES FRY-TOP ELÉCTRICO ESTRIADO CROMADO SUPERCHROME (MOCA APPROVED), PLANCHA CM.76X51 - 2 ZONAS DE COCCIÓN (INCLUIDA 1 CHAPA DE CIERRE PARA TOP MOD. TPA-7)**
cm. 80x 70,5x 28h



⚡ 11,1 kW 4.128,00
400V~3N 103 / 0,35
230V~3
50/60 Hz



FTLT-712ET Fry-top elettrico liscio, piastra cm.116x51 - 2 zone di cottura (inclusa 1 testata chiusura piano mod.TPA-7)
EN Electric Fry-top smooth griddle, plate cm.116x51 - 2 cooking areas (included 1 Head end filler strip mod.TPA-7) • **DE** Griddleplatte elektrische glatt, platte cm.116x51 - 2 Heizzonen (inbegriffen 1 Abschluss-Element mod.TPA-7) • **FR** Plaque électriques lisse, plaque cm.116x51 - 2 zones de cuisson (inclus 1 Élément de jonction top mod.TPA-7) • **ES FRY-TOP ELÉCTRICO LISO, PLANCHA CM.116X51 - 2 ZONAS DE COCCIÓN (INCLUIDA 1 CHAPA DE CIERRE PARA TOP MOD. TPA-7)**
cm. 120x 70,5x 28h



⚡ 14,8 KW 4.183,00
400V~3N 114 / 0,51
50/60 Hz



FTLT-712ETS Fry-top elettrico liscio cromato SUPERCHROME (Moca Approved), piastra cm.116x51 - 2 zone di cottura (inclusa 1 testata chiusura piano mod. TPA-7)
EN Electric Fry-top smooth chromed griddle SUPERCHROME (Moca Approved), plate cm.116x51 - 2 cooking areas (included 1 Head end filler strip mod.TPA-7) • **DE** Griddleplatte elektrische glatt hartverchromt SUPERCHROME (Moca Approved), platte cm.116x51 - 2 Heizzonen (inbegriffen 1 Abschluss-Element mod.TPA-7) • **FR** Plaque électriques lisse chromée SUPERCHROME (Moca Approved), plaque cm.116x51 - 2 zones de cuisson (inclus 1 Élément de jonction top mod.TPA-7) • **ES FRY-TOP ELÉCTRICO LISO CROMADO SUPERCHROME (MOCA APPROVED), PLANCHA CM.116X51 - 2 ZONAS DE COCCIÓN (INCLUIDA 1 CHAPA DE CIERRE PARA TOP MOD.TPA-7)**
cm. 120x 70,5x 28h

⚡ 14,8 kW 5.213,00
400V~3N 114 / 0,51
50/60 Hz



FTLRT-712ET Fry-top elettrico 1/2 rigato + 1/2 liscio, piastra cm.116x51 - 2 zone di cottura (inclusa 1 testata chiusura piano mod.TPA-7)
EN Electric Fry-top 1/2 grooved + 1/2 smooth, plate cm.116x51 - 2 cooking areas (included 1 Head end filler strip mod.TPA-7) • **DE** Griddleplatte elektrische 1/2 gerillt + 1/2 glatt, platte cm.116x51 - 2 Heizzonen (inbegriffen 1 Abschluss-Element mod.TPA-7) • **FR** Plaque électriques 1/2 nervurée + 1/2 lisse, plaque cm.116x51 - 2 zones de cuisson (inclus 1 Élément de jonction top mod.TPA-7) • **ES FRY-TOP ELÉCTRICO 1/2 ESTRIADO + 1/2 LISO, PLANCHA CM.116X51 - 2 ZONAS DE COCCIÓN (INCLUIDA 1 CHAPA DE CIERRE PARA TOP MOD.TPA-7)**
cm. 120x 70,5x 28h



⚡ 14,8 kW 4.390,00
400V~3N 114 / 0,51
50/60 Hz



FTLRT-712ETS Fry-top elettrico 1/2 rigato + 1/2 liscio cromato SUPERCHROME (Moca Approved), piastra cm.116x51 - 2 zone di cottura (inclusa 1 testata chiusura piano mod.TPA-7)
EN Electric Fry-top 1/2 grooved + 1/2 smooth chromed griddle SUPERCHROME (Moca Approved), plate cm.116x51 - 2 cooking areas (included 1 Head end filler strip mod.TPA-7) • **DE** Griddleplatte elektrische 1/2 gerillt + 1/2 glatt hartverchromt SUPERCHROME (Moca Approved), platte cm.116x51 - 2 Heizzonen (inbegriffen 1 Abschluss-Element mod.TPA-7) • **FR** Plaque électriques 1/2 nervurée + 1/2 lisse chromée SUPERCHROME (Moca Approved), plaque cm.116x51 - 2 zones de cuisson (inclus 1 Élément de jonction top mod.TPA-7) • **ES FRY-TOP ELÉCTRICO 1/2 ESTRIADO + 1/2 LISO CROMADO SUPERCHROME (MOCA APPROVED), PLANCHA CM.116X51 - 2 ZONAS DE COCCIÓN (INCLUIDA 1 CHAPA DE CIERRE PARA TOP MOD.TPA-7)**
cm. 120x 70,5x 28h

⚡ 14,8 kW 5.529,00
400V~3N 114 / 0,51
50/60 Hz



FRY-TOP ELETTRICI - TOP

MOD. _____
COD. _____

DESCRIZIONE/DESCRIPTION/BEZEICHNUNG/DESCRIPTION/DESCRIPCIÓN
DIMENSIONI/DIMENSIONS/ABMESSUNGEN/DIMENSIONS/DIMENSIONES

POTENZA/POWER/LEISTUNG/PUISSANCE/POTENCIA
VOLTAGGIO/VOLTAGE/SPANNUNG/VOLTAGE/VOLTAJE

⚡ kW _____
kcal/h _____
V~ _____
Hz _____

PREZZO/PRICE €
PREIS/PRIX/PRECIO €
KG / M³

FTRT-712ET Fry-top elettrico rigato, piastra cm.116x51 - 2 zone di cottura (inclusa 1 testata chiusura piano mod.TPA-7)
18061233
EN Electric Fry-top grooved griddle, plate cm.116x51 - 2 cooking areas (included 1 Head end filler strip mod.TPA-7) • **DE** Griddleplatte elektrische gerillt, platte cm.116x51 - 2 Heizzonen (inbegriffen 1 Abschluss-Element mod.TPA-7) • **FR** Plaque électriques nervurée, plaque cm.116x51 - 2 zones de cuisson (inclus 1 Élément de jonction top mod.TPA-7) • **ES FRY-TOP ELÉCTRICO ESTRIADO, PLANCHA CM.116X51 - 2 ZONAS DE COCCIÓN (INCLUIDA 1 CHAPA DE CIERRE PARA TOP MOD.TPA-7)**
cm. 120x 70,5x 28h

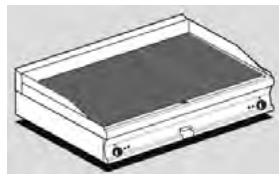

⚡ 14,8 kW _____ **4.611,00**
400V~3N _____ 114 / 0,51
50/60 Hz _____



FTRT-712ETS Fry-top elettrico rigato cromato SUPERCHROME (Moca Approved), piastra cm.116x51 - 2 zone di cottura (inclusa 1 testata chiusura piano mod.TPA-7)
18061236
EN Electric Fry-top grooved chromed griddle SUPERCHROME (Moca Approved), plate cm.116x51 - 2 cooking areas (included 1 Head end filler strip mod.TPA-7) • **DE** Griddleplatte elektrische gerillt hartverchromt SUPERCHROME (Moca Approved), platte cm.116x51 - 2 Heizzonen (inbegriffen 1 Abschluss-Element mod.TPA-7) • **FR** Plaque électriques nervurée chromée SUPERCHROME (Moca Approved), plaque cm.116x51 - 2 zones de cuisson (inclus 1 Élément de jonction top mod.TPA-7) • **ES FRY-TOP ELÉCTRICO ESTRIADO CROMADO SUPERCHROME (MOCA APPROVED), PLANCHA CM.116X51 - 2 ZONAS DE COCCIÓN (INCLUIDA 1 CHAPA DE CIERRE PARA TOP MOD.TPA-7)**
cm. 120x 70,5x 28h

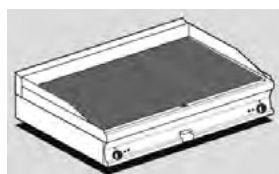

⚡ 14,8 kW _____ **5.935,00**
400V~3N _____ 114 / 0,51
50/60 Hz _____



FTLT-712ET3 Fry-top elettrico liscio, piastra cm.116x51 - 3 zone di cottura (inclusa 1 testata chiusura piano mod.TPA-7)
18061238
EN Electric Fry-top smooth griddle, plate cm.116x51 - 3 cooking areas (included 1 Head end filler strip mod.TPA-7) • **DE** Griddleplatte elektrische glatt, platte cm.116x51 - 3 Heizzonen (inbegriffen 1 Abschluss-Element mod.TPA-7) • **FR** Plaque électriques lisse, plaque cm.116x51 - 3 zones de cuisson (inclus 1 Élément de jonction top mod.TPA-7) • **ES FRY-TOP ELÉCTRICO LISO, PLANCHA CM.116X51 - 3 ZONAS DE COCCIÓN (INCLUIDA 1 CHAPA DE CIERRE PARA TOP MOD.TPA-7)**
cm. 120x 70,5x 28h



⚡ 16,65 kW _____ **4.744,00**
400V~3N _____ 114 / 0,51
50/60 Hz _____



FTLT-712ETS3 Fry-top elettrico liscio cromato SUPERCHROME (Moca Approved), piastra cm.116x51 - 3 zone di cottura (inclusa 1 testata chiusura piano mod.TPA-7)
1806123E
EN Electric Fry-top smooth chromed griddle SUPERCHROME (Moca Approved), plate cm.116x51 - 3 cooking areas (included 1 Head end filler strip mod.TPA-7) • **DE** Griddleplatte elektrische glatt hartverchromt SUPERCHROME (Moca Approved), platte cm.116x51 - 3 Heizzonen (inbegriffen 1 Abschluss-Element mod.TPA-7) • **FR** Plaque électriques lisse chromée SUPERCHROME (Moca Approved), plaque cm.116x51 - 3 zones de cuisson (inclus 1 Élément de jonction top mod.TPA-7) • **ES FRY-TOP ELÉCTRICO LISO CROMADO SUPERCHROME (MOCA APPROVED), PLANCHA CM.116X51 - 3 ZONAS DE COCCIÓN (INCLUIDA 1 CHAPA DE CIERRE PARA TOP MOD.TPA-7)**
cm. 120x 70,5x 28h

⚡ 16,65 kW _____ **5.615,00**
400V~3N _____ 114 / 0,51
50/60 Hz _____



FTLT-712ETSS3 Fry-top elettrico liscio CROMO LUCIDO, piastra cm.116x51 - 3 zone di cottura (inclusa 1 testata chiusura piano mod.TPA-7)
1806123Y
EN Electric Fry-top smooth POLISHED CHROME, plate cm.116x51 - 3 cooking areas (included 1 Head end filler strip mod.TPA-7) • **DE** Griddleplatte elektrische glatt POLIERTEM CHROM, platte cm.116x51 - 3 Heizzonen (inbegriffen 1 Abschluss-Element mod.TPA-7) • **FR** Plaque électriques lisse CHROME POLI, plaque cm.116x51 - 3 zones de cuisson (inclus 1 Élément de jonction top mod.TPA-7) • **ES FRY-TOP ELÉCTRICO LISO CROMO PULIDO, PLANCHA CM.116X51 - 3 ZONAS DE COCCIÓN (INCLUIDA 1 CHAPA DE CIERRE PARA TOP MOD.TPA-7)**
cm. 120x 70,5x 28h

⚡ 16,65 kW _____ **5.615,00**
400V~3N _____ 114 / 0,51
50/60 Hz _____



FRY-TOP ELETTRICI - TOP

MOD. / DESCRIZIONE / DESCRIPTION / BEZEICHNUNG / DESCRIPTION / DESCRIPCIÓN / DIMENSIONI / DIMENSIONS / ABMESSUNGEN / DIMENSIONS / DIMENSIONES / POTENZA / POWER / LEISTUNG / PUISSANCE / POTENCIA / VOLTAGGIO / VOLTAGE / SPANNUNG / VOLTAGE / VOLTAJE / kcal/h / kw / V~ / Hz / PREZZO / PRICE / PREIS / PRIX / PRECIO / KG / M³ / €

FTLRT-712ET3 Fry-top elettrico 1/3 rigato + 2/3 liscio, piastra cm.116x51 - 3 zone di cottura (inclusa 1 testata chiusura piano mod.TPA-7)
1806123C
EN Electric Fry-top 1/3 grooved + 2/3 smooth, plate cm.116x51 - 3 cooking areas (included 1 Head end filler strip mod.TPA-7) • **DE** Griddleplatte elektrische 1/3 gerillt + 2/3 glatt, platte cm.116x51 - 3 Heizzonen (inbegriffen 1 Abschluss-Element mod.TPA-7) • **FR** Plaque électriques 1/3 nervurée + 2/3 lisse, plaque cm.116x51 - 3 zones de cuisson (inclus 1 Élément de jonction top mod.TPA-7) • **ES FRY-TOP ELÉCTRICO 1/3 ESTRIADO + 2/3 LISO, PLANCHA CM.116X51 - 3 ZONAS DE COCCIÓN (INCLUIDA 1 CHAPA DE CIERRE PARA TOP MOD.TPA-7)**
cm. 120x 70,5x 28h



16,65 kW
 400V~3N
 50/60 Hz
4.875,00
 114 / 0,51



FTLRT-712ETS3 Fry-top elettrico 1/3 rigato + 2/3 liscio cromato SUPERCHROME (Moca Approved), piastra cm.116x51 - 3 zone di cottura (inclusa 1 testata chiusura piano mod.TPA-7)
1806123F
EN Electric Fry-top 1/3 grooved + 2/3 smooth chromed griddle SUPERCHROME (Moca Approved), plate cm.116x51 - 3 cooking areas (included 1 Head end filler strip mod.TPA-7) • **DE** Griddleplatte elektrische 1/3 gerillt + 2/3 glatt hartverchromt SUPERCHROME (Moca Approved), platte cm.116x51 - 3 Heizzonen (inbegriffen 1 Abschluss-Element mod.TPA-7) • **FR** Plaque électriques 1/3 nervurée + 2/3 lisse chromée SUPERCHROME (Moca Approved), plaque cm.116x51 - 3 zones de cuisson (inclus 1 Élément de jonction top mod.TPA-7) • **ES FRY-TOP ELÉCTRICO 1/3 ESTRIADO + 2/3 LISO CROMADO SUPERCHROME (MOCA APPROVED), PLANCHA CM.116X51 - 3 ZONAS DE COCCIÓN (INCLUIDA 1 CHAPA DE CIERRE PARA TOP MOD.TPA-7)**
cm. 120x 70,5x 28h

16,65 kW
 400V~3N
 50/60 Hz
5.822,00
 114 / 0,51



FTLT-74G Fry-top gas liscio, piastra cm.36x51 (inclusa 1 testata chiusura piano mod.TPA-7)
18230451
EN Gas Fry-top smooth griddle, plate cm.36x51 (included 1 Head end filler strip mod.TPA-7) • **DE** Gas-griddleplatte glatt, platte cm.36x51 (inbegriffen 1 Abschluss-Element mod.TPA-7) • **FR** Plaque gaz lisse, plaque cm.36x51 (inclus 1 Élément de jonction top mod.TPA-7) • **ES FRY-TOP GAS LISO, PLANCHA CM.36X51 (INCLUIDA 1 CHAPA DE CIERRE PARA TOP MOD.TPA-7)**
cm. 40x 70,5x 28h



7 kW
 6.020 kcal/h
1.956,00
 63 / 0,18



FTLT-74GS Fry-top gas liscio cromato SUPERCHROME (Moca Approved), piastra cm.36x51 (inclusa 1 testata chiusura piano mod.TPA-7)
18230454
EN Gas Fry-top smooth chromed griddle SUPERCHROME (Moca Approved), plate cm.36x51 (included 1 Head end filler strip mod.TPA-7) • **DE** Gas-griddleplatte glatt hartverchromt SUPERCHROME (Moca Approved), platte cm.36x51 (inbegriffen 1 Abschluss-Element mod.TPA-7) • **FR** Plaque gaz lisse chromée SUPERCHROME (Moca Approved), plaque cm.36x51 (inclus 1 Élément de jonction top mod.TPA-7) • **ES FRY-TOP GAS LISO CROMADO SUPERCHROME (MOCA APPROVED), PLANCHA CM.36X51 (INCLUIDA 1 CHAPA DE CIERRE PARA TOP MOD.TPA-7)**
cm. 40x 70,5x 28h

7 kW
 6.020 kcal/h
2.434,00
 63 / 0,18



FTLT-74GSS Fry-top gas liscio CROMO LUCIDO, piastra cm.36x51 (inclusa 1 testata chiusura piano mod.TPA-7)
18230450
EN Gas Fry-top smooth POLISHED CHROME, plate cm.36x51 (included 1 Head end filler strip mod.TPA-7) • **DE** Gas-griddleplatte glatt POLIERTEM CHROM, platte cm.36x51 (inbegriffen 1 Abschluss-Element mod.TPA-7) • **FR** Plaque gaz lisse CHROME POLI, plaque cm.36x51 (inclus 1 Élément de jonction top mod.TPA-7) • **ES FRY-TOP GAS LISO CROMO PULIDO, PLANCHA CM.36X51 (INCLUIDA 1 CHAPA DE CIERRE PARA TOP MOD.TPA-7)**
cm. 40x 70,5x 28h

7 kW
 6.020 kcal/h
2.434,00
 63 / 0,18



FRY-TOP A GAS - TOP

MOD. _____
COD.

DESCRIZIONE/DESCRIPTION/BEZEICHNUNG/DESCRIPTION/DESCRIPCIÓN
DIMENSIONI/DIMENSIONS/ABMESSUNGEN/DIMENSIONES/DIMENSIONES

POTENZA/POWER/LEISTUNG/PUISSANCE/POTENCIA
VOLTAGGIO/VOLTAGE/SPANNUNG/VOLTAGE/VOLTAGE

⚡ kW
kcal/h

⚡ kW
V-
Hz

PREZZO/PRICE €
PREIS/PRIX/PRECIO €
KG / M³

FTRT-74G
18230453

Fry-top gas rigato, piastra cm.36x51 (inclusa 1 testata chiusura piano mod.TPA-7)
EN Gas Fry-top grooved griddle, plate cm.36x51 (included 1 Head end filler strip mod.TPA-7) • **DE** Gas-griddleplatte gerillt, platte cm.36x51 (inbegriffen 1 Abschluss-Element mod.TPA-7) • **FR** Plaque gaz nervurée, plaque cm.36x51 (inclus 1 Élément de jonction top mod.TPA-7) • **ES FRY-TOP GAS ESTRIADO, PLANCHA CM.36X51 (INCLUIDA 1 CHAPA DE CIERRE PARA TOP MOD.TPA-7)**
cm. 40x 70,5x 28h

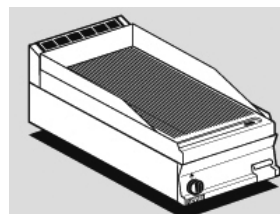

⚡ 7 kW
6.020 kcal/h

2.171,00
63 / 0,18



FTRT-74GS
18230456

Fry-top gas rigato cromato SUPERCHROME (Moca Approved), piastra cm.36x51 (inclusa 1 testata chiusura piano mod.TPA-7)
EN Gas Fry-top grooved chromed griddle SUPERCHROME (Moca Approved), plate cm.36x51 (included 1 Head end filler strip mod.TPA-7) • **DE** Gas-griddleplatte gerillt hartverchromt SUPERCHROME (Moca Approved), platte cm.36x51 (inbegriffen 1 Abschluss-Element mod.TPA-7) • **FR** Plaque gaz nervurée chromée SUPERCHROME (Moca Approved), plaque cm.36x51 (inclus 1 Élément de jonction top mod.TPA-7) • **ES FRY-TOP GAS ESTRIADO CROMADO SUPERCHROME (MOCA APPROVED), PLANCHA CM.36X51 (INCLUIDA 1 CHAPA DE CIERRE PARA TOP MOD.TPA-7)**
cm. 40x 70,5x 28h

⚡ 7 kW
6.020 kcal/h

2.652,00
63 / 0,18



FTLT-76G
18230651

Fry-top gas liscio, piastra cm.56x51 (inclusa 1 testata chiusura piano mod.TPA-7)
EN Gas Fry-top smooth griddle, plate cm.56x51 (included 1 Head end filler strip mod.TPA-7) • **DE** Gas-griddleplatte glatt, platte cm.56x51 (inbegriffen 1 Abschluss-Element mod.TPA-7) • **FR** Plaque gaz lisse, plaque cm.56x51 (inclus 1 Élément de jonction top mod.TPA-7) • **ES FRY-TOP GAS LISO, PLANCHA CM.56X51 (INCLUIDA 1 CHAPA DE CIERRE PARA TOP MOD.TPA-7)**
cm. 60x 70,5x 28h



⚡ 10,5 kW
9.030 kcal/h

2.398,00
68 / 0,26



FTLT-76GS
18230654

Fry-top gas liscio cromato SUPERCHROME (Moca Approved), piastra cm.56x51 (inclusa 1 testata chiusura piano mod.TPA-7)
EN Gas Fry-top smooth chromed griddle SUPERCHROME (Moca Approved), plate cm.56x51 (included 1 Head end filler strip mod.TPA-7) • **DE** Gas-griddleplatte glatt hartverchromt SUPERCHROME (Moca Approved), platte cm.56x51 (inbegriffen 1 Abschluss-Element mod.TPA-7) • **FR** Plaque gaz lisse chromée SUPERCHROME (Moca Approved), plaque cm.56x51 (inclus 1 Élément de jonction top mod.TPA-7) • **ES FRY-TOP GAS LISO CROMADO SUPERCHROME (MOCA APPROVED), PLANCHA CM.56X51 (INCLUIDA 1 CHAPA DE CIERRE PARA TOP MOD.TPA-7)**
cm. 60x 70,5x 28h

⚡ 10,5 kW
9.030 kcal/h

2.987,00
68 / 0,26

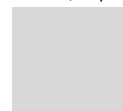

FTLT-76GSS
18230650

Fry-top gas liscio CROMO LUCIDO, piastra cm.56x51 (inclusa 1 testata chiusura piano mod.TPA-7)
EN Gas Fry-top smooth POLISHED CHROME, plate cm.56x51 (included 1 Head end filler strip mod.TPA-7) • **DE** Gas-griddleplatte glatt POLIERTEM CHROM, platte cm.56x51 (inbegriffen 1 Abschluss-Element mod.TPA-7) • **FR** Plaque gaz lisse CHROME POLI, plaque cm.56x51 (inclus 1 Élément de jonction top mod.TPA-7) • **ES FRY-TOP GAS LISO CROMO PULIDO, PLANCHA CM.56X51 (INCLUIDA 1 CHAPA DE CIERRE PARA TOP MOD.TPA-7)**
cm. 60x 70,5x 28h

⚡ 10,5 kW
9.030 kcal/h

2.987,00
68 / 0,26

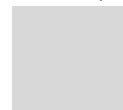

FTLRT-76G
18230652

Fry-top gas 1/2 rigato + 1/2 liscio, piastra cm.56x51 (inclusa 1 testata chiusura piano mod.TPA-7)
EN Gas Fry-top 1/2 grooved + 1/2 smooth, plate cm.56x51 (included 1 Head end filler strip mod.TPA-7) • **DE** Gas-griddleplatte 1/2 gerillt + 1/2 glatt, platte cm.56x51 (inbegriffen 1 Abschluss-Element mod.TPA-7) • **FR** Plaque gaz 1/2 nervurée + 1/2 lisse, plaque cm.56x51 (inclus 1 Élément de jonction top mod.TPA-7) • **ES FRY-TOP GAS 1/2 ESTRIADO + 1/2 LISO, PLANCHA CM.56X51 (INCLUIDA 1 CHAPA DE CIERRE PARA TOP MOD.TPA-7)**
cm. 60x 70,5x 28h



⚡ 10,5 kW
9.030 kcal/h

2.568,00
68 / 0,26



FRY-TOP A GAS - TOP

MOD. _____ DESCRIZIONE/DESCRIPTION/BEZEICHNUNG/DESCRIPTION/DESCRIPCIÓN POTENZA/POWER/LEISTUNG/PUISSANCE/POTENCIA $\frac{kW}{kcal/h}$ $\frac{kW}{V-Hz}$ PREZZO/PRICE € $\frac{€}{KG / M^3}$
 COD. _____ DIMENSIONI/DIMENSIONS/ABMESSUNGEN/DIMENSIONS/DIMENSIONES VOLTAGGIO/VOLTAGE/SPANNUNG/VOLTAGE/VOLTAJE

FTLRT-76GS Fry-top gas 1/2 rigato + 1/2 liscio cromato SUPERCHROME (Moca Approved), piastra cm.56x51 (inclusa 1 testata chiusura piano mod.TPA-7) **18230655**

EN Gas Fry-top 1/2 grooved + 1/2 smooth chromed griddle SUPERCHROME (Moca Approved), plate cm.56x51 (included 1 Head end filler strip mod.TPA-7) • **DE** Gas-griddleplatte 1/2 gerillt + 1/2 glatt hartverchromt SUPERCHROME (Moca Approved), platte cm.56x51 (inbegriffen 1 Abschluss-Element mod.TPA-7) • **FR** Plaque gaz 1/2 nervurée + 1/2 lisse chromée SUPERCHROME (Moca Approved), plaque cm.56x51 (inclus 1 Élément de jonction top mod.TPA-7) • **ES FRY-TOP GAS 1/2 ESTRIADO + 1/2 LISO CROMADO SUPERCHROME (MOCA APPROVED), PLANCHA CM.56X51 (INCLUIDA 1 CHAPA DE CIERRE PARA TOP MOD.TPA-7)**

cm. 60x 70,5x 28h



$\frac{10,5 kW}{9.030 kcal/h}$ **3.161,00**
68 / 0,26



FTRT-76G Fry-top gas rigato, piastra cm.56x51 (inclusa 1 testata chiusura piano mod.TPA-7) **18230653**

EN Gas Fry-top grooved griddle, plate cm.56x51 (included 1 Head end filler strip mod.TPA-7) • **DE** Gas-griddleplatte gerillt, platte cm.56x51 (inbegriffen 1 Abschluss-Element mod.TPA-7) • **FR** Plaque gaz nervurée, plaque cm.56x51 (inclus 1 Élément de jonction top mod.TPA-7) • **ES FRY-TOP GAS ESTRIADO, PLANCHA CM.56X51 (INCLUIDA 1 CHAPA DE CIERRE PARA TOP MOD.TPA-7)**

cm. 60x 70,5x 28h

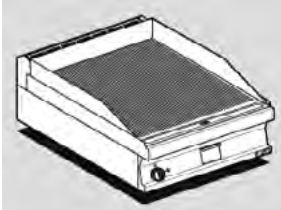

$\frac{10,5 kW}{9.030 kcal/h}$ **2.740,00**
68 / 0,26



FTRT-76GS Fry-top gas rigato cromato SUPERCHROME (Moca Approved), piastra cm.56x51 (inclusa 1 testata chiusura piano mod.TPA-7) **18230656**

EN Gas Fry-top grooved chromed griddle SUPERCHROME (Moca Approved), plate cm.56x51 (included 1 Head end filler strip mod.TPA-7) • **DE** Gas-griddleplatte gerillt hartverchromt SUPERCHROME (Moca Approved), platte cm.56x51 (inbegriffen 1 Abschluss-Element mod.TPA-7) • **FR** Plaque gaz nervurée chromée SUPERCHROME (Moca Approved), plaque cm.56x51 (inclus 1 Élément de jonction top mod.TPA-7) • **ES FRY-TOP GAS ESTRIADO CROMADO SUPERCHROME (MOCA APPROVED), PLANCHA CM.56X51 (INCLUIDA 1 CHAPA DE CIERRE PARA TOP MOD.TPA-7)**

cm. 60x 70,5x 28h

$\frac{10,5 kW}{9.030 kcal/h}$ **3.333,00**
68 / 0,26



FTLT-78G Fry-top gas liscio, piastra cm.76x51 - 2 zone di cottura (inclusa 1 testata chiusura piano mod.TPA-7) **18230851**

EN Gas Fry-top smooth griddle, plate cm.76x51 - 2 cooking areas (included 1 Head end filler strip mod.TPA-7) • **DE** Gas-griddleplatte glatt, platte cm.76x51 - 2 Heizzonen (inbegriffen 1 Abschluss-Element mod.TPA-7) • **FR** Plaque gaz lisse, plaque cm.76x51 - 2 zones de cuisson (inclus 1 Élément de jonction top mod.TPA-7) • **ES FRY-TOP GAS LISO, PLANCHA CM.76X51 - 2 ZONAS DE COCCIÓN (INCLUIDA 1 CHAPA DE CIERRE PARA TOP MOD.TPA-7)**

cm. 80x 70,5x 28h



$\frac{14 kW}{12.040 kcal/h}$ **3.534,00**
108 / 0,35



FTLT-78GS Fry-top gas liscio cromato SUPERCHROME (Moca Approved), piastra cm.76x51 - 2 zone di cottura (inclusa 1 testata chiusura piano mod.TPA-7) **18230854**

EN Gas Fry-top smooth chromed griddle SUPERCHROME (Moca Approved), plate cm.76x51 - 2 cooking areas (included 1 Head end filler strip mod.TPA-7) • **DE** Gas-griddleplatte glatt hartverchromt SUPERCHROME (Moca Approved), platte cm.76x51 - 2 Heizzonen (inbegriffen 1 Abschluss-Element mod.TPA-7) • **FR** Plaque gaz lisse chromée SUPERCHROME (Moca Approved), plaque cm.76x51 - 2 zones de cuisson (inclus 1 Élément de jonction top mod.TPA-7) • **ES FRY-TOP GAS LISO CROMADO SUPERCHROME (MOCA APPROVED), PLANCHA CM.76X51 - 2 ZONAS DE COCCIÓN (INCLUIDA 1 CHAPA DE CIERRE PARA TOP MOD.TPA-7)**

cm. 80x 70,5x 28h

$\frac{14 kW}{12.040 kcal/h}$ **4.402,00**
108 / 0,35



FRY-TOP A GAS - TOP

MOD. _____
COD. _____

DESCRIZIONE/DESCRIPTION/BEZEICHNUNG/DESCRIPTION/DESCRIPCIÓN
DIMENSIONI/DIMENSIONS/ABMESSUNGEN/DIMENSIONS/DIMENSIONES

POTENZA/POWER/LEISTUNG/PUISSANCE/POTENCIA
VOLTAGGIO/VOLTAGE/SPANNUNG/VOLTAGE/VOLTAJE

14 kW
12.040 kcal/h

PREZZO/PRICE €
PREIS/PRIX/PRECIO €
KG / M³

FTLT-78GS Fry-top gas liscio CROMO LUCIDO, piastra cm.76x51 - 2 zone di cottura (inclusa 1 testata chiusura piano mod.TPA-7)
EN Gas Fry-top smooth POLISHED CHROME, plate cm.76x51 - 2 cooking areas (included 1 Head end filler strip mod.TPA-7) • **DE** Gas-griddleplatte glatt POLIERTEM CHROM, platte cm.76x51 - 2 Heizzonen (inbegriffen 1 Abschluss-Element mod.TPA-7) • **FR** Plaque gaz lisse CHROME POLI, plaque cm.76x51 - 2 zones de cuisson (inclus 1 Elément de jonction top mod.TPA-7) • **ES FRY-TOP GAS LISO CROMO PULIDO, PLANCHA CM.76X51 - 2 ZONAS DE COCCIÓN (INCLUIDA 1 CHAPA DE CIERRE PARA TOP MOD.TPA-7)**



14 kW 4.402,00
12.040 kcal/h 108 / 0,35

cm. 80x 70,5x 28h

FTLRT-78G Fry-top gas 1/2 rigato + 1/2 liscio, piastra cm.76x51 - 2 zone di cottura (inclusa 1 testata chiusura piano mod.TPA-7)
EN Gas Fry-top 1/2 grooved + 1/2 smooth, plate cm.76x51 - 2 cooking areas (included 1 Head end filler strip mod.TPA-7) • **DE** Gas-griddleplatte 1/2 gerillt + 1/2 glatt, platte cm.76x51 - 2 Heizzonen (inbegriffen 1 Abschluss-Element mod.TPA-7) • **FR** Plaque gaz 1/2 nervurée + 1/2 lisse, plaque cm.76x51 - 2 zones de cuisson (inclus 1 Elément de jonction top mod.TPA-7) • **ES FRY-TOP GAS 1/2 ESTRIADO + 1/2 LISO, PLANCHA CM.76X51 - 2 ZONAS DE COCCIÓN (INCLUIDA 1 CHAPA DE CIERRE PARA TOP MOD.TPA-7)**



14 kW 3.738,00
12.040 kcal/h 108 / 0,35

cm. 80x 70,5x 28h

FTLRT-78GS Fry-top gas 1/2 rigato + 1/2 liscio cromato SUPERCHROME (Moca Approved), piastra cm.76x51 - 2 zone di cottura (inclusa 1 testata chiusura piano mod.TPA-7)
EN Gas Fry-top 1/2 grooved + 1/2 smooth chromed griddle SUPERCHROME (Moca Approved), plate cm.76x51 - 2 cooking areas (included 1 Head end filler strip mod.TPA-7) • **DE** Gas-griddleplatte 1/2 gerillt + 1/2 glatt hartverchromt SUPERCHROME (Moca Approved), platte cm.76x51 - 2 Heizzonen (inbegriffen 1 Abschluss-Element mod.TPA-7) • **FR** Plaque gaz 1/2 nervurée + 1/2 lisse chromée SUPERCHROME (Moca Approved), plaque cm.76x51 - 2 zones de cuisson (inclus 1 Elément de jonction top mod.TPA-7) • **ES FRY-TOP GAS 1/2 ESTRIADO + 1/2 LISO CROMADO SUPERCHROME (MOCA APPROVED), PLANCHA CM.76X51 - 2 ZONAS DE COCCIÓN (INCLUIDA 1 CHAPA DE CIERRE PARA TOP MOD.TPA-7)**



14 kW 4.607,00
12.040 kcal/h 108 / 0,35

cm. 80x 70,5x 28h

FTRT-78G Fry-top gas rigato, piastra cm.76x51 - 2 zone di cottura (inclusa 1 testata chiusura piano mod.TPA-7)
EN Gas Fry-top grooved griddle, plate cm.76x51 - 2 cooking areas (included 1 Head end filler strip mod.TPA-7) • **DE** Gas-griddleplatte gerillt, platte cm.76x51 - 2 Heizzonen (inbegriffen 1 Abschluss-Element mod.TPA-7) • **FR** Plaque gaz nervurée, plaque cm.76x51 - 2 zones de cuisson (inclus 1 Elément de jonction top mod.TPA-7) • **ES FRY-TOP GAS ESTRIADO, PLANCHA CM.76X51 - 2 ZONAS DE COCCIÓN (INCLUIDA 1 CHAPA DE CIERRE PARA TOP MOD.TPA-7)**



14 kW 3.945,00
12.040 kcal/h 108 / 0,35

cm. 80x 70,5x 28h

FTRT-78GS Fry-top gas rigato cromato SUPERCHROME (Moca Approved), piastra cm.76x51 - 2 zone di cottura (inclusa 1 testata chiusura piano mod.TPA-7)
EN Gas Fry-top grooved chromed griddle SUPERCHROME (Moca Approved), plate cm.76x51 - 2 cooking areas (included 1 Head end filler strip mod.TPA-7) • **DE** Gas-griddleplatte gerillt hartverchromt SUPERCHROME (Moca Approved), platte cm.76x51 - 2 Heizzonen (inbegriffen 1 Abschluss-Element mod.TPA-7) • **FR** Plaque gaz nervurée chromée SUPERCHROME (Moca Approved), plaque cm.76x51 - 2 zones de cuisson (inclus 1 Elément de jonction top mod.TPA-7) • **ES FRY-TOP GAS ESTRIADO CROMADO SUPERCHROME (MOCA APPROVED), PLANCHA CM.76X51 - 2 ZONAS DE COCCIÓN (INCLUIDA 1 CHAPA DE CIERRE PARA TOP MOD.TPA-7)**



14 kW 4.812,00
12.040 kcal/h 108 / 0,35

cm. 80x 70,5x 28h

FRY-TOP A GAS - TOP

MOD. _____ DESCRIZIONE/DESCRIPTION/BEZEICHNUNG/DESCRIPTION/DESCRIPCIÓN POTENZA/POWER/LEISTUNG/PUISSANCE/POTENCIA ⚡ kW ⚡ kw PREZZO/PRICE €
 COD. _____ DIMENSIONI/DIMENSIONS/ABMESSUNGEN/DIMENSIONS/DIMENSIONES VOLTAGGIO/VOLTAGE/SPANNUNG/VOLTAGE/VOLTAJE kcal/h kcal/h V~ / Hz PREIS/PRIX/PRECIO € KG / M³

FTLT-712G Fry-top gas liscio, piastra cm.116x51 - 2 zone di cottura (inclusa 1 testata chiusura piano mod.TPA-7)
 18231251 **EN** Gas Fry-top smooth griddle, plate cm.116x51 - 2 cooking areas (included 1 Head end filler strip mod.TPA-7) • **DE** Gas-griddleplatte glatt, platte cm.116x51 - 2 Heizzonen (inbegriffen 1 Abschluss-Element mod.TPA-7) • **FR** Plaque gaz lisse, plaque cm.116x51 - 2 zones de cuisson (inclus 1 Élément de jonction top mod.TPA-7) • **ES FRY-TOP GAS LISO, PLANCHA CM.116X51 - 2 ZONAS DE COCCIÓN (INCLUIDA 1 CHAPA DE CIERRE PARA TOP MOD.TPA-7) cm. 120x 70,5x 28h**



⚡ 21 kW 4.674,00
 18.060 kcal/h 120 / 0,51



FTLT-712GS Fry-top gas liscio cromato SUPERCHROME (Moca Approved), piastra cm.116x51 - 2 zone di cottura (inclusa 1 testata chiusura piano mod.TPA-7)
 18231254 **EN** Gas Fry-top smooth chromed griddle SUPERCHROME (Moca Approved), plate cm.116x51 - 2 cooking areas (included 1 Head end filler strip mod.TPA-7) • **DE** Gas-griddleplatte glatt hartverchromt SUPERCHROME (Moca Approved), platte cm.116x51 - 2 Heizzonen (inbegriffen 1 Abschluss-Element mod.TPA-7) • **FR** Plaque gaz lisse chromée SUPERCHROME (Moca Approved), plaque cm.116x51 - 2 zones de cuisson (inclus 1 Élément de jonction top mod.TPA-7) • **ES FRY-TOP GAS LISO CROMADO SUPERCHROME (MOCA APPROVED), PLANCHA CM.116X51 - 2 ZONAS DE COCCIÓN (INCLUIDA 1 CHAPA DE CIERRE PARA TOP MOD.TPA-7) cm. 120x 70,5x 28h**

⚡ 21 kW 5.577,00
 18.060 kcal/h 120 / 0,51



FTLRT-712G Fry-top gas 1/2 rigato + 1/2 liscio, piastra cm.116x51 - 2 zone di cottura (inclusa 1 testata chiusura piano mod.TPA-7)
 18231252 **EN** Gas Fry-top 1/2 grooved + 1/2 smooth, plate cm.116x51 - 2 cooking areas (included 1 Head end filler strip mod.TPA-7) • **DE** Gas-griddleplatte 1/2 gerillt + 1/2 glatt, platte cm.116x51 - 2 Heizzonen (inbegriffen 1 Abschluss-Element mod.TPA-7) • **FR** Plaque gaz 1/2 nervurée + 1/2 lisse, plaque cm.116x51 - 2 zones de cuisson (inclus 1 Élément de jonction top mod.TPA-7) • **ES FRY-TOP GAS 1/2 ESTRIADO + 1/2 LISO, PLANCHA CM.116X51 - 2 ZONAS DE COCCIÓN (INCLUIDA 1 CHAPA DE CIERRE PARA TOP MOD.TPA-7) cm. 120x 70,5x 28h**



⚡ 21 kW 4.925,00
 18.060 kcal/h 120 / 0,51



FTLRT-712GS Fry-top gas 1/2 rigato + 1/2 liscio cromato SUPERCHROME (Moca Approved), piastra cm.116x51 - 2 zone di cottura (inclusa 1 testata chiusura piano mod.TPA-7)
 18231255 **EN** Gas Fry-top 1/2 grooved + 1/2 smooth chromed griddle SUPERCHROME (Moca Approved), plate cm.116x51 - 2 cooking areas (included 1 Head end filler strip mod.TPA-7) • **DE** Gas-griddleplatte 1/2 gerillt + 1/2 glatt hartverchromt SUPERCHROME (Moca Approved), platte cm.116x51 - 2 Heizzonen (inbegriffen 1 Abschluss-Element mod.TPA-7) • **FR** Plaque gaz 1/2 nervurée + 1/2 lisse chromée SUPERCHROME (Moca Approved), plaque cm.116x51 - 2 zones de cuisson (inclus 1 Élément de jonction top mod.TPA-7) • **ES FRY-TOP GAS 1/2 ESTRIADO + 1/2 LISO CROMADO SUPERCHROME (MOCA APPROVED), PLANCHA CM.116X51 - 2 ZONAS DE COCCIÓN (INCLUIDA 1 CHAPA DE CIERRE PARA TOP MOD.TPA-7) cm. 120x 70,5x 28h**

⚡ 21 kW 5.780,00
 18.060 kcal/h 120 / 0,51



FTRT-712G Fry-top gas rigato, piastra cm.116x51 - 2 zone di cottura (inclusa 1 testata chiusura piano mod.TPA-7)
 18231253 **EN** Gas Fry-top grooved griddle, plate cm.116x51 - 2 cooking areas (included 1 Head end filler strip mod.TPA-7) • **DE** Gas-griddleplatte gerillt, platte cm.116x51 - 2 Heizzonen (inbegriffen 1 Abschluss-Element mod.TPA-7) • **FR** Plaque gaz nervurée, plaque cm.116x51 - 2 zones de cuisson (inclus 1 Élément de jonction top mod.TPA-7) • **ES FRY-TOP GAS ESTRIADO, PLANCHA CM.116X51 - 2 ZONAS DE COCCIÓN (INCLUIDA 1 CHAPA DE CIERRE PARA TOP MOD.TPA-7) cm. 120x 70,5x 28h**



⚡ 21 kW 5.178,00
 18.060 kcal/h 120 / 0,51



FRY-TOP A GAS - TOP

MOD. _____
COD. _____

DESCRIZIONE/DESCRIPTION/BEZEICHNUNG/DESCRIPTION/DESCRIPCIÓN
DIMENSIONI/DIMENSIONS/ABMESSUNGEN/DIMENSIONS/DIMENSIONES

POTENZA/POWER/LEISTUNG/PUISSANCE/POTENCIA
VOLTAGGIO/VOLTAGE/SPANNUNG/VOLTAGE/VOLTAJE

⚡ 21 kW
18.060 kcal/h

PREZZO/PRICE €
PREIS/PRIX/PRECIO €
KG / M³

FTRT-712GS Fry-top gas rigato cromato SUPERCHROME (Moca Approved), piastra cm.116x51 - 2 zone di cottura (inclusa 1 testata chiusura piano mod. TPA-7)
EN Gas Fry-top grooved chromed griddle SUPERCHROME (Moca Approved), plate cm.116x51 - 2 cooking areas (included 1 Head end filler strip mod.TPA-7) • **DE** Gas-griddleplatte gerillt hartverchromt SUPERCHROME (Moca Approved), platte cm.116x51 - 2 Heizzonen (inbegriffen 1 Abschluss-Element mod.TPA-7) • **FR** Plaque gaz nervurée chromée SUPERCHROME (Moca Approved), plaque cm.116x51 - 2 zones de cuisson (inclus 1 Élément de jonction top mod.TPA-7) • **ES FRY-TOP GAS ESTRIADO CROMADO SUPERCHROME (MOCA APPROVED), PLANCHA CM.116X51 - 2 ZONAS DE COCCIÓN (INCLUIDA 1 CHAPA DE CIERRE PARA TOP MOD.TPA-7) cm. 120x 70,5x 28h**

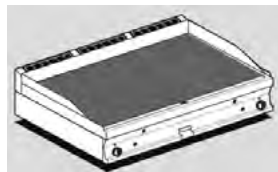

⚡ 21 kW **6.046,00**
18.060 kcal/h 120 / 0,51



FTLT-712G3 Fry-top gas liscio, piastra cm.116x51 - 3 zone di cottura (inclusa 1 testata chiusura piano mod.TPA-7)
EN Gas Fry-top smooth griddle, plate cm.116x51 - 3 cooking areas (included 1 Head end filler strip mod.TPA-7) • **DE** Gas-griddleplatte glatt, platte cm.116x51 - 3 Heizzonen (inbegriffen 1 Abschluss-Element mod.TPA-7) • **FR** Plaque gaz lisse, plaque cm.116x51 - 3 zones de cuisson (inclus 1 Élément de jonction top mod.TPA-7) • **ES FRY-TOP GAS LISO, PLANCHA CM.116X51 - 3 ZONAS DE COCCIÓN (INCLUIDA 1 CHAPA DE CIERRE PARA TOP MOD.TPA-7) cm. 120x 70,5x 28h**



⚡ 21 kW **5.078,00**
18.060 kcal/h 120 / 0,51



FTLT-712GS3 Fry-top gas liscio cromato SUPERCHROME (Moca Approved), piastra cm.116x51 - 3 zone di cottura (inclusa 1 testata chiusura piano mod. TPA-7)
EN Gas Fry-top smooth chromed griddle SUPERCHROME (Moca Approved), plate cm.116x51 - 3 cooking areas (included 1 Head end filler strip mod.TPA-7) • **DE** Gas-griddleplatte glatt hartverchromt SUPERCHROME (Moca Approved), platte cm.116x51 - 3 Heizzonen (inbegriffen 1 Abschluss-Element mod.TPA-7) • **FR** Plaque gaz lisse chromée SUPERCHROME (Moca Approved), plaque cm.116x51 - 3 zones de cuisson (inclus 1 Élément de jonction top mod.TPA-7) • **ES FRY-TOP GAS LISO CROMADO SUPERCHROME (MOCA APPROVED), PLANCHA CM.116X51 - 3 ZONAS DE COCCIÓN (INCLUIDA 1 CHAPA DE CIERRE PARA TOP MOD.TPA-7) cm. 120x 70,5x 28h**

⚡ 21 kW **5.934,00**
18.060 kcal/h 120 / 0,51



FTLT-712GS53 Fry-top gas liscio CROMO LUCIDO, piastra cm.116x51 - 3 zone di cottura (inclusa 1 testata chiusura piano mod.TPA-7)
EN Gas Fry-top smooth POLISHED CHROME, plate cm.116x51 - 3 cooking areas (included 1 Head end filler strip mod.TPA-7) • **DE** Gas-griddleplatte glatt POLIERTEM CHROM, platte cm.116x51 - 3 Heizzonen (inbegriffen 1 Abschluss-Element mod.TPA-7) • **FR** Plaque gaz lisse CHROME POLI, plaque cm.116x51 - 3 zones de cuisson (inclus 1 Élément de jonction top mod.TPA-7) • **ES FRY-TOP GAS LISO CROMO PULIDO, PLANCHA CM.116X51 - 3 ZONAS DE COCCIÓN (INCLUIDA 1 CHAPA DE CIERRE PARA TOP MOD.TPA-7) cm. 120x 70,5x 28h**

⚡ 21 kW **5.934,00**
18.060 kcal/h 120 / 0,51



FTLRT-712G3 Fry-top gas 1/3 rigato + 2/3 liscio, piastra cm.116x51 - 3 zone di cottura (inclusa 1 testata chiusura piano mod.TPA-7)
EN Gas Fry-top 1/3 grooved + 2/3 smooth, plate cm.116x51 - 3 cooking areas (included 1 Head end filler strip mod.TPA-7) • **DE** Gas-griddleplatte 1/3 gerillt + 2/3 glatt, platte cm.116x51 - 3 Heizzonen (inbegriffen 1 Abschluss-Element mod.TPA-7) • **FR** Plaque gaz 1/3 nervurée + 2/3 lisse, plaque cm.116x51 - 3 zones de cuisson (inclus 1 Élément de jonction top mod.TPA-7) • **ES FRY-TOP GAS 1/3 ESTRIADO + 2/3 LISO, PLANCHA CM.116X51 - 3 ZONAS DE COCCIÓN (INCLUIDA 1 CHAPA DE CIERRE PARA TOP MOD. TPA-7) cm. 120x 70,5x 28h**



⚡ 21 kW **5.208,00**
18.060 kcal/h 120 / 0,51



FRY-TOP A GAS - TOP

MOD. _____ DESCRIZIONE/DESCRIPTION/BEZEICHNUNG/DESCRIPTION/DESCRIPCIÓN POTENZA/POWER/LEISTUNG/PUISSANCE/POTENCIA ⚡ kW ⚡ kw PREZZO/PRICE €
 COD. _____ DIMENSIONI/DIMENSIONS/ABMESSUNGEN/DIMENSIONS/DIMENSIONES VOLTAGGIO/VOLTAGE/SPANNUNG/VOLTAGE/VOLTAJE kcal/h V~ /- Hz PREIS/PRIX/PRECIO €
 KG / M³

FTLRT-712GS3 Fry-top gas 1/3 rigato + 2/3 liscio cromato SUPERCHROME (Moca Approved), piastra cm.116x51 - 3 zone di cottura (inclusa 1 testata chiusura piano mod.TPA-7)
EN Gas Fry-top 1/3 grooved + 2/3 smooth chromed griddle SUPERCHROME (Moca Approved), plate cm.116x51 - 3 cooking areas (included 1 Head end filler strip mod.TPA-7) • **DE** Gas-griddleplatte 1/3 gerillt + 2/3 glatt hartverchromt SUPERCHROME (Moca Approved), platte cm.116x51 - 3 Heizzonen (inbegriffen 1 Abschluss-Element mod.TPA-7) • **FR** Plaque gaz 1/3 nervurée + 2/3 lisse chromée SUPERCHROME (Moca Approved), plaque cm.116x51 - 3 zones de cuisson (inclus 1 Elément de jonction top mod.TPA-7) • **ES FRY-TOP GAS 1/3 ESTRIADO + 2/3 LISO CROMADO SUPERCHROME (MOCA APPROVED), PLANCHA CM.116X51 - 3 ZONAS DE COCCIÓN (INCLUIDA 1 CHAPA DE CIERRE PARA TOP MOD.TPA-7)**
cm. 120x 70,5x 28h



⚡ 21 kW
 18.060 kcal/h

6.137,00
 120 / 0,51



CWKT-74ET GRIGLIA CONTACT - cottura diretta su resistenza in acciaio inox cm. 27x43 ribaltabile (inclusa 1 testata chiusura piano mod.TPA-7)
EN CONTACT Grill threephase - rotatable stainless steel grill cm. 27x43 (included 1 Head end filler strip mod.TPA-7) • **DE** Wurstbrater dreiphasig KONTAKT - Drehbaren Heizelement aus Edelstahl cm. 27x43 (inbegriffen 1 Abschluss-Element mod.TPA-7) • **FR** Grillade triphase CONTACT - Grille inox rotatif cm 27x43 (inclus 1 Elément de jonction top mod.TPA-7) • **ES PARRILLA TRIFÁSICO CONTACT - PARRILLA GIRATORIA DE ACERO INOX CM 27X43 (INCLUIDA 1 CHAPA DE CIERRE PARA TOP MOD.TPA-7)**
cm. 40x 70,5x 28h



⚡ 4,08 KW
 400V~3N
 50/60 Hz

3.083,00
 55 / 0,18

CWKT-78ET GRIGLIA CONTACT - cottura diretta su resistenza in acciaio inox cm. 55x43 ribaltabile - 2 zone cottura (inclusa 1 testata chiusura piano mod.TPA-7)
EN CONTACT Grill threephase - rotatable stainless steel grill cm. 55x43 - 2 cooking areas (included 1 Head end filler strip mod.TPA-7) • **DE** Wurstbrater dreiphasig KONTAKT - Drehbaren Heizelement aus Edelstahl cm. 55x43 - 2 Heizzonen (inbegriffen 1 Abschluss-Element mod.TPA-7) • **FR** Grillade triphase CONTACT - Grille inox rotatif cm 55x43 - 2 zones de cuisson (inclus 1 Elément de jonction top mod.TPA-7) • **ES PARRILLA TRIFÁSICO CONTACT - PARRILLA GIRATORIA DE ACERO INOX CM 55X43 - 2 ZONAS DE COCCIÓN (INCLUIDA 1 CHAPA DE CIERRE PARA TOP MOD.TPA-7)**
cm. 80x 70,5x 28h

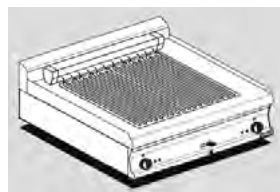

⚡ 8,16 KW
 400V~3N
 50/60 Hz

4.162,00
 85 / 0,35

CWT-74ET GRIGLIA TRIFASE Griglia in acciaio inox cm. 38x52 regolabile (inclusa 1 testata chiusura piano mod.TPA-7)
EN Grill threephase - Stainless steel grill cm. 38x52 (included 1 Head end filler strip mod.TPA-7) • **DE** Wurstbrater dreiphasig - Einstellbarer Rost aus Nirosta cm. 38x52 (inbegriffen 1 Abschluss-Element mod.TPA-7) • **FR** Grillade triphase - Grille inox cm 38x52 (inclus 1 Elément de jonction top mod.TPA-7) • **ES PARRILLA TRIFÁSICO - PARRILLA DE ACERO INOX REGULABLE CM 38X52 (INCLUIDA 1 CHAPA DE CIERRE PARA TOP MOD.TPA-7)**
cm. 40x 70,5x 28h



⚡ 6 kW
 400V~3N
 230V~3
 50/60 Hz

2.225,00
 57 / 0,18

CWT-78ET GRIGLIA TRIFASE N. 2 griglie in acciaio inox cm. 38x52 regolabili 2 zone di cottura (inclusa 1 testata chiusura piano mod.TPA-7)
EN Grill threephase - N. 2 Stainless steel grill cm. 38x52. 2 cooking areas (included 1 Head end filler strip mod.TPA-7) • **DE** Wurstbrater dreiphasig - N. 2 einstellbare Roste aus Nirosta cm. 38x52 - 2 Heizzonen (inbegriffen 1 Abschluss-Element mod.TPA-7) • **FR** Grillade triphase - N. 2 grilles réglables en acier inox cm. 38x52 - 2 zones de cuisson (inclus 1 Elément de jonction top mod.TPA-7) • **ES PARRILLA TRIFÁSICO - N. 2 PARRILLAS DE ACERO INOX REGULABLE CM 38X52 - 2 ZONAS DE COCCIÓN (INCLUIDA 1 CHAPA DE CIERRE PARA TOP MOD.TPA-7)**
cm. 80x 70,5x 28h



⚡ 12 kW
 400V~3N
 230V~3
 50/60 Hz

3.358,00
 87 / 0,35

GRIGLIE PIETRA LAVICA A GAS - TOP

MOD. _____
COD. _____

DESCRIZIONE/DESCRIPTION/BEZEICHNUNG/DESCRIPTION/DESCRIPCIÓN
DIMENSIONI/DIMENSIONS/ABMESSUNGEN/DIMENSIONS/DIMENSIONES

POTENZA/POWER/LEISTUNG/PUISSANCE/POTENCIA
VOLTAGGIO/VOLTAGE/SPANNUNG/VOLTAGE/VOLTAJE

⚡ kW _____
kcal/h _____
V- _____
Hz _____

PREZZO/PRICE € _____
PREIS/PRIX/PRECIO € _____
KG / M³ _____

CWT-74G
18250450

GRIGLIA GAS-PIETRALAVICA Griglia in acciaio inox cm. 38x52 regolabile (inclusa 1 testata chiusura piano mod.TPA-7)
EN Charcoal grill gas - Stainless steel grill cm. 38x52 (included 1 Head end filler strip mod.TPA-7) • **DE** Gas-Lavasteingrill - Einstellbarer Rost aus Nirosta cm. 38x52 (inbegriffen 1 Abschluss-Element mod.TPA-7) • **FR** Grille à gaz en pierre de lave - Grille inox cm 38x52 (inclus 1 Élément de jonction top mod.TPA-7) • **ES PARRILLA A GAS PIEDRA LÁVICA - PARRILLA DE ACERO INOX REGULABLE CM 38X52 (INCLUIDA 1 CHAPA DE CIERRE PARA TOP MOD.TPA-7)**
cm. 40x 70,5x 28h



⚡ 9 kW _____ **2.352,00**
7.740 kcal/h _____ 56 / 0,21

CWT-78G
18250850

GRIGLIA GAS-PIETRALAVICA N. 2 griglie in acciaio inox cm. 38x52 regolabili 2 zone di cottura (inclusa 1 testata chiusura piano mod.TPA-7)
EN Charcoal grill gas - N. 2 Stainless steel grill cm. 38x52 2 cooking areas (included 1 Head end filler strip mod.TPA-7) • **DE** Gas-Lavasteingrill - N. 2 einstellbare Roste aus Nirosta cm. 38x52 - 2 Heizzonen (inbegriffen 1 Abschluss-Element mod.TPA-7) • **FR** Grille a gaz en pierre de lave - N. 2 grilles réglables en acier inox cm. 38x52 - 2 zones de cuisson (inclus 1 Élément de jonction top mod.TPA-7) • **ES PARRILLA A GAS PIEDRA LÁVICA - N. 2 PARRILLAS DE ACERO INOX REGULABLE CM 38X52 - 2 ZONAS DE COCCIÓN (INCLUIDA 1 CHAPA DE CIERRE PARA TOP MOD.TPA-7)**
cm. 80x 70,5x 28h



⚡ 18 kW _____ **3.670,00**
15.480 kcal/h _____ 97 / 0,40

F2/8T-74ET
18090432

FRIGGITRICE TRIFASE LT. 8+8 2 Vasche cm. 14,8x35,5x22,5h - 2 cesti cm. 12x29x11,5h - Filtro e coperchio vasca. Produzione patate: 12 kg/h (inclusa 1 testata chiusura piano mod.TPA-7)
EN Fryer threephase 8+8 lts - 2 Bowls cm. 14,8x35,5x22,5h - 2 baskets cm. 12x29x11,5h. Sieve and lid for pan. Production: 12 kg/h (included 1 Head end filler strip mod.TPA-7) • **DE** Friteuse dreiphasig lt. 8+8 - 2 Becken cm. 14,8x35,5x22,5h - 2 Korb cm. 12x29x11,5h. Einlegesieb und Deckel für Becken. Pommes frites: 12 kg/h (inbegriffen 1 Abschluss-Element mod.TPA-7) • **FR** Friteuse triphase lt. 8+8 - 2 Cuve cm. 14,8x35,5x22,5h - 2 Panier cm. 12x29x11,5h. Filtre, couvercle pour cuve. Production de pommes frites: 12 kg/h (inclus 1 Élément de jonction top mod.TPA-7) • **ES FREIDORAS TRIFÁSICO 8+8 LT. - 2CUBA CM. 14,8X35,5X22,5H- 2 CESTA CM. 12X29X11,5H. FILTRO Y TAPA PARA CUBA. PROD. PATATAS: 12 KG/H (INCLUIDA 1 CHAPA DE CIERRE PARA TOP MOD.TPA-7)**
cm. 40x 70,5x 28h



⚡ 12 kW _____ **3.310,00**
400V-3N _____ 50 / 0,18
230V-3 _____
50/60 Hz _____

F13T-74ET
18090430

FRIGGITRICE TRIFASE LT. 13 Vasca cm. 30,5x34x22,5h - 1 cesto cm. 28x29x10h Filtro e coperchio vasca - Produzione patate: 10 kg/h (inclusa 1 testata chiusura piano mod.TPA-7)
EN Fryer threephase 13 lts - Bowl cm. 30,5x34x22,5h 1 basket cm. 28x29x10h - Sieve and lid for pan Production: 10 kg/h (included 1 Head end filler strip mod.TPA-7) • **DE** Friteuse dreiphasig lt. 13 - Becken cm. 30,5x34x22,5h - 1 Korb cm. 28x29x10h - Einlegesieb und Deckel für Becken - Pommes frites: 10 kg/h (inbegriffen 1 Abschluss-Element mod.TPA-7) • **FR** Friteuse triphase lt. 13 - Cuve cm. 30,5x34x22,5h - 1 Panier cm. 28x29x10h - Filtre, couvercle pour cuve Production de pommes frites: 10 kg/h (inclus 1 Élément de jonction top mod.TPA-7) • **ES FREIDORAS TRIFÁSICO 13 LT. - CUBA CM. 30,5X34X22,5H - 1 CESTA CM. 28X29X10H - FILTRO Y TAPA PARA CUBA. PROD. PATATAS: 10 KG/H (INCLUIDA 1 CHAPA DE CIERRE PARA TOP MOD.TPA-7)**
cm. 40x 70,5x 28h



⚡ 10,95 kW _____ **2.343,00**
400V-3N _____ 48 / 0,18
50/60 Hz _____

FRIGGITRICI ELETTRICHE - TOP

MOD. _____ DESCRIZIONE/DESCRIPTION/BEZEICHNUNG/DESCRIPTION/DESCRIPCIÓN POTENZA/POWER/LEISTUNG/PUISSANCE/POTENCIA ⚡ kW ⚡ kW PREZZO/PRICE €
 COD. _____ DIMENSIONI/DIMENSIONS/ABMESSUNGEN/DIMENSIONS/DIMENSIONES VOLTAGGIO/VOLTAGE/SPANNUNG/VOLTAGE/VOLTAJE kcal/h V~ Hz PREIS/PRIX/PRECIO €
 KG / M³

F2/13T-78ET FRIGGITRICE TRIFASE LT. 13+13 2 vasche cm. 30,5x34x22,5h - 2 cestì
 18090830 cm. 28x29x10h 2 filtri e coperchi vasche - Produzione patate: 20 kg/h
 (inclusa 1 testata chiusura piano mod.TPA-7)
EN Fryer threephase 13+13 lts - 2 pans cm. 30,5x34x22,5h 2 baskets
 cm. 28x29x10h - 2 sieves and lids for pan Production: 20 kg/h (included 1
 Head end filler strip mod.TPA-7) • **DE** Friteuse dreiphasig lt. 13+13 - 2
 Becken cm. 30,5x34x22,5h 2 Körbe cm. 28x29x10h - Einlegesieb und
 Deckel für Becken - Pommes frites: 20 kg/h (inbegriffen 1 Abschluss-
 Element mod.TPA-7) • **FR** Friteuse triphase lt. 13+13 - 2 cuves cm.
 30,5x34x22,5h 2 paniers cm. 28x29x10h - 2 filtres, couvercles pour
 cuve Production de pommes frites: 20 kg/h (inclus 1 Élément de jonction
 top mod.TPA-7) • **ES FREIDORAS TRIFÁSICO 13+13 LT. - 2**
CUBAS CM. 30,5X34X22,5H - 2 CESTAS CM. 28X29X10H .
2 FILTROS Y TAPAS PARA CUBAS PROD. PATATAS: 20 KG/H
(INCLUIDA 1 CHAPA DE CIERRE PARA TOP MOD.TPA-7)
cm. 80x 70,5x 28h



⚡ 21,9 kW **3.712,00**
 400V~3N 75 / 0,35
 50/60 Hz

F2/8T-74G FRIGGITRICE GAS LT. 8+8 - 2 vasche cm. 15x35x23h 2 cestì cm.
 18260452 12x30x9,5h. Filtro e coperchio vasca. Prod. patate: 12 kg/h (inclusa 1
 testata chiusura piano mod.TPA-7)
EN Gas Fryer 8+8 lts - 2 pans cm. 15x35x23h 2 baskets cm.
 12x30x9,5h. Sieve and lid for pan. Production: 12 kg/h (included 1
 Head end filler strip mod.TPA-7) • **DE** Gas-Friteuse lt. 8+8 - 2 Becken
 cm. 15x35x23h 2 Körbe cm. 12x30x9,5h. Einlegesieb und Deckel für
 Becken. Pommes frites: 12 kg/h (inbegriffen 1 Abschluss-Element mod.
 TPA-7) • **FR** Friteuse à gaz lt. 8+8 - 2 cuves cm. 15x35x23h 2 paniers
 cm. 12x30x9,5h. Filtre, couvercle pour cuve. Production de pommes frites:
 12 kg/h (inclus 1 Élément de jonction top mod.TPA-7) • **ES FREIDORAS**
A GAS 8+8 LT. - 2 CUBAS CM. 15X35X23H 2 CESTAS CM.
12X30X9,5H. FILTRO Y TAPA PARA CUBA. PROD. PATATAS:
12 KG/H (INCLUIDA 1 CHAPA DE CIERRE PARA TOP MOD.
TPA-7)
cm. 40x 70,5x 28h



⚡ 9 kW **3.842,00**
 7.740 kcal/h 50 / 0,18

F13T-74G FRIGGITRICE GAS LT. 13 - Vasca cm. 31,5x34,5x22,5h 1 cesto cm.
 18260450 28x29x10h - Filtro e coperchio vasca. Prod. patate: 10 kg/h (inclusa 1
 testata chiusura piano mod.TPA-7)
EN Gas Fryer 13 lts - Bowl cm. 31,5x34,5x22,5h - 1 basket cm.
 28x29x10h - Sieve and lid for pan Production: 10 kg/h (included 1
 Head end filler strip mod.TPA-7) • **DE** Gas-Friteuse lt. 13 - Becken cm.
 31,5x34,5x22,5h - 1 Korb cm. 28x29x10h - Einlegesieb und Deckel für
 Becken - Pommes frites: 10 kg/h (inbegriffen 1 Abschluss-Element mod.
 TPA-7) • **FR** Friteuse à gaz lt. 13 - Cuve cm. 31,5x34,5x22,5h - 1 Panier
 cm. 28x29x10h - Filtre, couvercle pour cuve Production de pommes frites:
 10 kg/h (inclus 1 Élément de jonction top mod.TPA-7) • **ES FREIDORAS**
A GAS 13 LT. - CUBA CM. 31,5X34,5X22,5H - 1 CESTA CM.
28X29X10H - FILTRO Y TAPA PARA CUBA PROD. PATATAS:
10 KG/H (INCLUIDA 1 CHAPA DE CIERRE PARA TOP MOD.
TPA-7)
cm. 40x 70,5x 28h



⚡ 12 kW **2.575,00**
 10.320 kcal/h 55 / 0,18

F2/13T-78G FRIGGITRICE GAS LT. 13+13 2 vasche cm. 31,5x34,5x22,5h - 2 cestì cm.
 18260850 28x29x10h 2 filtri e coperchi vasche - Prod. patate: 20 kg/h (inclusa 1
 testata chiusura piano mod.TPA-7)
EN Gas Fryer 13+13 lts - 2 pans cm. 31,5x34,5x22,5h 2 baskets cm.
 28x29x10h - 2 sieves and lids for pan Production: 20 kg/h (included 1
 Head end filler strip mod.TPA-7) • **DE** Gas-Friteuse lt. 13+13 - 2 Becken
 cm. 31,5x34,5x22,5h 2 Körbe cm. 28x29x10h - Einlegesieb und Deckel
 für Becken - Pommes frites: 20 kg/h (inbegriffen 1 Abschluss-Element mod.
 TPA-7) • **FR** Friteuse à gaz lt. 13+13 - 2 cuves cm. 31,5x34,5x22,5h
 2 paniers cm. 28x29x10h - 2 filtres, couvercles pour cuve Production
 de pommes frites: 20 kg/h (inclus 1 Élément de jonction top mod.
 TPA-7) • **ES FREIDORAS A GAS 13+13 LT. - 2 CUBAS CM.**
31,5X34,5X22,5H 2 CESTAS CM. 28X29X10H - 2 FILTROS Y
TAPAS PARA CUBAS. PROD. PATATAS: 20 KG/H (INCLUIDA 1
CHAPA DE CIERRE PARA TOP MOD.TPA-7)
cm. 80x 70,5x 28h



⚡ 24 kW **4.090,00**
 20.640 kcal/h 81 / 0,35

BASE CON FORNO ELETTRICO

MOD. _____
COD. _____

DESCRIZIONE/DESCRIPTION/BEZEICHNUNG/DESCRIPTION/DESCRIPCIÓN
DIMENSIONI/DIMENSIONS/ABMESSUNGEN/DIMENSIONS/DIMENSIONES

POTENZA/POWER/LEISTUNG/PUISSANCE/POTENCIA
VOLTAGGIO/VOLTAGE/SPANNUNG/VOLTAGE/VOLTAGE

⚡ kW _____
kcal/h _____
V~ _____
Hz _____

PREZZO/PRICE €
PREIS/PRIX/PRECIO €
KG / M³

MFV-78ET
08490830

Base con Forno elettrico ventilato cm. 55x36x34h, temp: 50÷300°C, con 1 griglia cm.53x32,5 GN1/1 (non sovrapporre elementi ad induzione)
EN Stand with electric fan oven cm. 55x36x34h, temp: 50÷300°C, with 1 grid cm.53x32,5 GN1/1 (no induction top) • **DE** unterbau mit Elektro-Heißluftofen cm. 55x36x34h, temp: 50÷300°C, mit 1 Rost cm.53x32,5 GN1/1 (nicht Induktions) • **FR** placard avec Four à chaleur tournante électrique cm. 55x36x34h, temp: 50÷300°C, avec 1 grille cm.53x32,5 GN1/1 (il faut pas de induction) • **ES MUEBLE CON HORNO ELÉCTRICO VENTILADO CM. 55X36X34H, TEMP: 50÷300°C, CON 1 PARILLA CM.53X32,5 GN1/1 (NO INDUCCIÓN) cm. 80x 63x 57h**



⚡ 5,32 kW _____ **3.726,00**
400V~3N _____ 55 / 0,49
230V~3 _____
50/60 Hz _____

MF-710ET
08491030

Base con Forno elettrico statico cm. 67x55x34h, temp: 50÷300°C, con 1 griglia cm.65x53 GN2/1 (non sovrapporre elementi ad induzione)
EN Stand with traditional electric oven cm. 67x55x34h, temp: 50÷300°C, with 1 grid cm.65x53 GN2/1 (no induction top) • **DE** unterbau mit Statischer Elektro-Backofen cm. 67x55x34h, temp: 50÷300°C, mit 1 Rost cm.65x53 GN2/1 (nicht Induktions) • **FR** placard avec Four électrique statique cm. 67x55x34h, temp: 50÷300°C, avec 1 grille cm.65x53 GN2/1 (il faut pas de induction) • **ES MUEBLE CON HORNO ELÉCTRICO ESTÁTICO CM. 67X55X34H, TEMP: 50÷300°C, CON 1 PARILLA CM.65X53 GN2/1 (NO INDUCCIÓN) cm. 100x 63x 57h**

⚡ 5 kW _____ **3.522,00**
400V~3N _____ 60 / 0,73
50/60 Hz _____

CMF-78
08490800

COPERCHIO per MFV-78E
EN Lid for MFV-78E • **DE** Berichterstattung für MFV-78E • **FR** Couvercle pour MFV-78E • **ES CUBERTURA PARA MFV-78E cm. 80x 62,5x 2,8h**

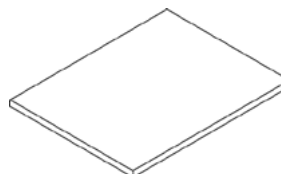

262,00
5 / 0,03

CMF-710
08491000

COPERCHIO per MF-710E
EN Lid for MF-710E • **DE** Berichterstattung für MF-710E • **FR** Couvercle pour MF-710E • **ES CUBERTURA PARA MF-710E cm. 100x 62,5x 2,8h**

318,00
6 / 0,03

MPI-74
08410403

BASE CON PORTA PER INDUZIONE
EN Stand with door for induction top • **DE** Unterbau für Induktions mit Tür • **FR** Placard pour induction avec porte • **ES MUEBLE BASE PARA INDUCCIÓN CON PUERTA cm. 40x 62x 57h**



725,00
20 / 0,21

MPI-78
08410803

cm. 80x 62x 57h



820,00
27 / 0,40

M-72
08410200

BASE NEUTRA
EN Stand • **DE** Unterbau • **FR** Placard • **ES MUEBLE BASE cm. 20x 59,5x 57h**



441,00
12 / 0,17

MOBILI BASE

MOD. _____ DESCRIZIONE/DESCRIPTION/BEZEICHNUNG/DESCRIPTION/DESCRIPCIÓN POTENZA/POWER/LEISTUNG/PUISSANCE/POTENCIA kW kcal/h kw V~ Hz PREZZO/PRICE € KG / M³
 COD. _____ DIMENSIONI/DIMENSIONS/ABMESSUNGEN/DIMENSIONS/DIMENSIONES VOLTAGGIO/VOLTAGE/SPANNUNG/VOLTAGE/VOLTAJE

M-73 BASE NEUTRA a giorno
 08410300 **EN** Open Stand • **DE** Offener Unterbau • **FR** Placard ouvert • **ES** MUEBLE BASE ABIERTO
 cm. 30x 59,5x 57h **446,00**
 14 / 0,21



M-74
 08410400 cm. 40x 59,5x 57h **453,00**
 17 / 0,21



M-76
 08410600 cm. 60x 59,5x 57h **508,00**
 21 / 0,31

M-78
 08410800 cm. 80x 59,5x 57h **545,00**
 24 / 0,40



M-712
 08411200 cm. 120x 59,5x 57h **770,00**
 35 / 0,40

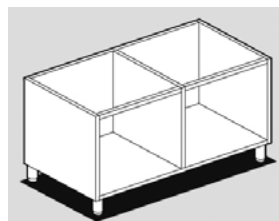

M-716
 08411600 cm. 160x 59,5x 57h **920,00**
 52 / 0,79

PM-63/73/93-DX PORTA 300 DESTRA
 08430302 **EN** Right door 300 • **DE** Rechte tür 300 • **FR** Porte droite 300 • **ES** PUERTA DERECHA 300
 cm. 29,5x 2,5x 47,5h **213,00**
 3 / 0,01



PM-64/74/94-DX PORTA 400 DESTRA
 08430402 **EN** Right door 400 • **DE** Rechte tür 400 • **FR** Porte droite 400 • **ES** PUERTA DERECHA 400
 cm. 39,5x 2,5x 47,5h **220,00**
 3.5 / 0,02



PM-63/73/93-SX PORTA 300 SINISTRA
 08430303 **EN** Left door 300 • **DE** Linke tür 300 • **FR** Porte gauche 300 • **ES** PUERTA IZQUIERDA 300
 cm. 29,5x 2,5x 47,5h **213,00**
 3 / 0,01

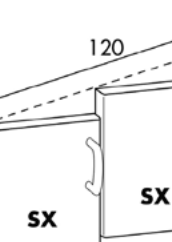

PM-64/74/94-SX PORTA 400 SINISTRA
 08430403 **EN** Left door 400 • **DE** Linke tür 400 • **FR** Porte gauche 400 • **ES** PUERTA IZQUIERDA 400
 cm. 39,5x 2,5x 47,5h **220,00**
 3.5 / 0,02

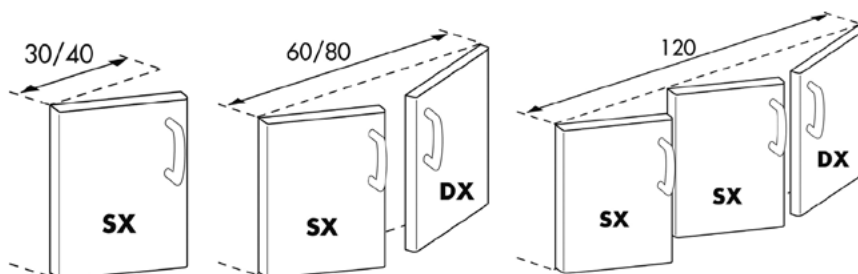

ACCESSORI TOP

MOD. _____
COD. _____

DESCRIZIONE/DESCRIPTION/BEZEICHNUNG/DESCRIPTION/DESCRIPCIÓN
DIMENSIONI/DIMENSIONS/ABMESSUNGEN/DIMENSIONS/DIMENSIONES

POTENZA/POWER/LEISTUNG/PUISSANCE/POTENCIA
VOLTAGGIO/VOLTAGE/SPANNUNG/VOLTAGE/VOLTAJE

⚡ kW kcal/h
⚡ kw V~ Hz

PREZZO/PRICE €
PREIS/PRIX/PRECIO €
KG / M³

C-73/93
08440320

CASSETTIERA 300 N. 2 cassetti con 2 bacinelle inox, guide telescopiche.
EN Drawer set 300 N. 2 drawers with 2 inox containers, telescopic guides. • **DE** Schubladen 300 - N. 2 Schubladen mit 2 Chromnickelstahlbehältern, Telescopeinführungen. • **FR** Tiroirs pour meuble de 300 N. 2 tiroirs avec 2 bacs inox, guides télescopiques. • **ES CAJONERA 300 - N. 2 CAJONES CON 2 CONTENEDORES DE ACERO INOX, GUÍAS TELESCÓPICAS.**
cm. 29,5x 59x 47,5h



827,00
16 / 0,19

C-74/94
08440420

CASSETTIERA 400 - N. 2 cassetti con 2 bacinelle GN 1/1 15h in plastica, guide telescopiche.
EN Drawer set 400 - N. 2 drawers with 2 GN 1/1 15h plastic containers, telescopic guides. • **DE** Schubladen - N. 2 Schubladen mit 2 GN 1/1 15h Kunststoffbehältern, Telescopeinführungen. • **FR** Tiroirs pour meuble de 400 - N. 2 tiroirs avec 2 bacs en plastique GN 1/1 15h, guides télescopiques. • **ES CAJONERA 400 - N. 2 CAJONES CON 2 CONTENEDORES GN 1/1 15H DE PLÁSTICO, GUÍAS TELESCÓPICAS.**
cm. 39,5x 59x 47,5h



849,00
18 / 0,19

C-76/96
08440620

CASSETTIERA 600 N. 2 cassetti con 2 bacinelle inox, guide telescopiche.
EN Drawer set 600 N. 2 drawers with 2 inox containers, telescopic guides. • **DE** Schubladen 600 - N. 2 Schubladen mit 2 Chromnickelstahlbehältern, Telescopeinführungen. • **FR** Tiroirs pour meuble de 600 N. 2 tiroirs avec 2 bacs inox, guides télescopiques. • **ES CAJONERA 600 - N. 2 CAJONES CON 2 CONTENEDORES DE ACERO INOX, GUÍAS TELESCÓPICAS.**
cm. 59,5x 59x 47,5h



1.173,00
22 / 0,28

C-78/98
08440820

CASSETTIERA 800 - N. 2 cassetti con 4 bacinelle GN 1/1 15h in plastica, guide telescopiche.
EN Drawer set 800 - N. 2 drawers with 4 GN 1/1 15h plastic containers, telescopic guides. • **DE** Schubladen 800 - N. 2 Schubladen mit 4 GN 1/1 15h Kunststoffbehältern, Telescopeinführungen. • **FR** Tiroirs pour meuble de 800 - N. 2 tiroirs avec 4 bacs en plastique GN 1/1 15h, guides télescopiques. • **ES CAJONERA 800 - N. 2 CAJONES CON 4 CONTENEDORES GN 1/1 15H DE PLÁSTICO, GUÍAS TELESCÓPICAS.**
cm. 79,5x 59x 47,5h



1.193,00
26 / 0,37

D-70
08470001

DIVISORIO base neutra
EN Spacer for stand • **DE** Trennwand für offener unterbau • **FR** Separation pour placard ouvert • **ES DIVISORIO PARA MUEBLE BASE**
cm. 5x 58x 38h

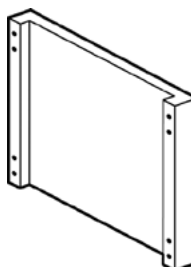

177,00
2.5 / 0,02

PT-74/94
08460002

PORTATEGLIE VANO 400/600 (GN-1/1) 4 ripiani int. 7 cm.
EN Frame for plates 400/600 (GN-1/1) - N. 4 shelves, wheel-base 7 cm. • **DE** Auflangeschienen für bleche 400/600 (GN-1/1) N. 4 Etagen, Abstand 7 cm. • **FR** Kit porte-plaques 400/600 (GN-1/1) - N. 4 étagères; 7 cm. • **ES PORTACAQUELAS 400/600 (GN-1/1) - N. 4 ESTANTES, INT. 7 CM.**

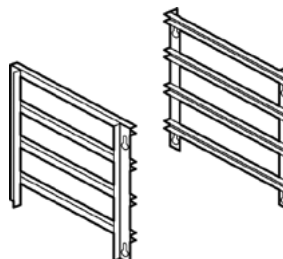

459,00
2.5 / 0,01

PT-78/98
08460012

PORTATEGLIE VANO 800 (GN-2/1) 4 ripiani int. 7 cm.
EN Frame for plates 800 (GN-2/1) 4 Etagen, Abstand 7 cm. • **DE** Auflangeschienen für bleche 800 (GN-2/1) N. 4 Etagen, Abstand 7 cm. • **FR** Kit porte-plaques 800 (GN-2/1) - N. 4 étagères; 7 cm. • **ES PORTACAQUELAS 800 (GN-2/1) - N. 4 ESTANTES, INT. 7 CM.**

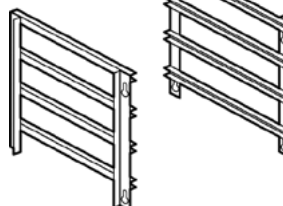

613,00
4 / 0,01

ACCESSORI FRIGGITRICI TOP

MOD. _____ DESCRIZIONE/DESCRIPTION/BEZEICHNUNG/DESCRIPTION/DESCRIPCIÓN POTENZA/POWER/LEISTUNG/PUISSANCE/POTENCIA ⚡kW ⚡kw PREZZO/PRICE €
 COD. _____ DIMENSIONI/DIMENSIONS/ABMESSUNGEN/DIMENSIONS/DIMENSIONES VOLTAGGIO/VOLTAGE/SPANNUNG/VOLTAGE/VOLTAJE kcal/h V~ Hz PREIS/PRIX/PRECIO €
 KG / M³

531048800 CESTO 1/2 per F13T-G/E
EN Basket 1/2 for F13T-G/E • **DE** Korb 1/2 zur Friteuse F13T-G/E
 • **FR** Panier 1/2 pour F13T-G/E • **ES CESTA 1/2 PARA F13T-G/E**
cm. 13,5x 29x 9h



98,00
 0.8 / 0,03

531018800 CESTO 1/2 PER CPT-74 - 1/3 PER CPT-76
EN Basket 1/2 for CPT-74 - 1/3 for CPT-76 • **DE** Korb 1/2 für CPT-74 -
 1/3 für CPT-76 • **FR** Panier 1/2 pour CPT-74 - 1/3 pour CPT-76 • **ES**
CESTA 1/2 PARA CPT-74 - 1/3 PARA CPT-76
cm. 14,5x 29x 15h

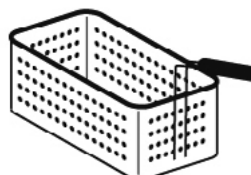

138,00
 1,3 / 0,04

..188..

531053800 CESTO 1/4 PER CPT-76
EN Basket 1/4 for CPT-76 • **DE** Korb 1/4 für CPT-76 • **FR** Panier 1/4
 pour CPT-76 • **ES CESTA 1/4 PARA CPT-76**
cm. 11,5x 29x 15h

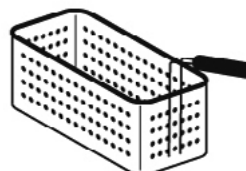

132,00
 1,2 / 0,04

..538..

531040000 CESTO 1/1 PER CPT-76
EN Basket 1/1 for CPT-76 • **DE** Korb 1/1 für CPT-76 • **FR** Panier 1/1
 pour CPT-76 • **ES CESTA 1/1 PARA CPT-76**
cm. 49x 29x 15h

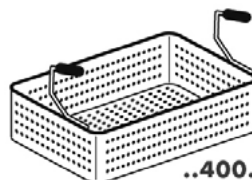

238,00
 3,5 / 0,07

..400..

531048900 CESTO 1/6 PER CPT-74
EN Basket 1/6 for CPT-74 • **DE** Korb 1/6 für CPT-74 • **FR** Panier 1/6
 pour CPT-74 • **ES CESTA 1/6 PARA CPT-74**
cm. 14x 10x 15h



86,00
 1 / 0,01

531053700 CESTO 1/4 PER CPT-74
EN Basket 1/4 for CPT-74 • **DE** Korb 1/4 für CPT-74 • **FR** Panier 1/4
 pour CPT-74 • **ES CESTA 1/4 PARA CPT-74**
cm. 14x 16x 15h

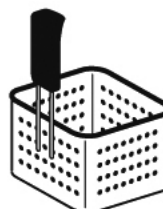

93,00
 1 / 0,02

..537..

ACCESSORI CUOCIPASTA TOP

MOD. COD.	DESCRIZIONE/DESCRIPTION/BEZEICHNUNG/DESCRIPTION/DESCRIPCIÓN DIMENSIONI/DIMENSIONS/ABMESSUNGEN/DIMENSIONS/DIMENSIONES	POTENZA/POWER/LEISTUNG/PUISSANCE/POTENCIA VOLTAGGIO/VOLTAGE/SPANNUNG/VOLTAGE/VOLTAJE	$\frac{kW}{kcal/h}$ $\frac{kw}{V\cdot Hz}$	PREZZO/PRICE PREIS/PRIX/PRECIO € KG / M ³
---------------------	---	---	--	---

531053500 CESTO 1/1 PER CPT-74
EN Basket 1/1 for CPT-74 • **DE** Korb 1/1 für CPT-74 • **FR** Panier 1/1 pour CPT-74 • **ES CESTA 1/1 PARA CPT-74**
cm. 29x 29x 15h

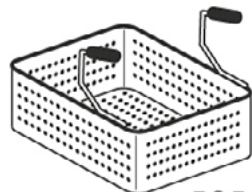

..535..

171,00
1,5 / 0,05

531071300 CESTO CON GANCIO 1/2 PER CPT-74 - 1/3 PER CPT-76
EN Basket with hook 1/2 for CPT-74 - 1/3 for CPT-76 • **DE** Korb mit Haken 1/2 für CPT-74 - 1/3 für CPT-76 • **FR** Panier avec crochet 1/2 pour CPT-74 - 1/3 pour CPT-76 • **ES CESTA CON GANCHO 1/2 PARA CPT-74 - 1/3 PARA CPT-76**
cm. 13,5x 25,5x 15h

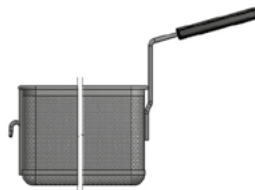

137,00
1,3 / 0,04

531071400 CESTO CON GANCIO 1/4 PER CPT-76
EN Basket with hook 1/4 for CPT-76 • **DE** Korb mit Haken 1/4 für CPT-76 • **FR** Panier avec crochet 1/4 pour CPT-76 • **ES CESTA CON GANCHO 1/4 PARA CPT-76**
cm. 11x 25,5x 15h

130,00
1,2 / 0,03

531071800 GRIGLIA SUPPORTO CESTI CON GANCIO PER CPT-74
EN support for baskets with hook for CPT-74 • **DE** Unterstützung für Körbe mit Haken für CPT-74 • **FR** soutien pour les paniers avec crochet pour CPT-74 • **ES SOPORTE PARA CESTAS CON GANCHO PARA CPT-74**
cm. 30x 33x 25h



138,00
3 / 0,04

531071900 GRIGLIA SUPPORTO CESTI CON GANCIO PER CPT-76
EN support for baskets with hook for CPT-76 • **DE** Unterstützung für Körbe mit Haken für CPT-76 • **FR** soutien pour les paniers avec crochet pour CPT-76 • **ES SOPORTE PARA CESTAS CON GANCHO PARA CPT-76**
cm. 50x 30x 25h

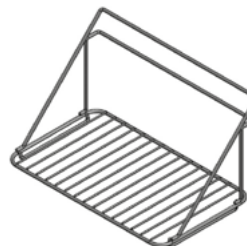

179,00
3,5 / 0,06



90

LOTUS®

CUCINE ELETTRICHE

MOD. _____
COD. _____

DESCRIZIONE/DESCRIPTION/BEZEICHNUNG/DESCRIPTION/DESCRIPCIÓN
DIMENSIONI/DIMENSIONS/ABMESSUNGEN/DIMENSIONS/DIMENSIONES

POTENZA/POWER/LEISTUNG/PUISSANCE/POTENCIA
VOLTAGGIO/VOLTAGE/SPANNUNG/VOLTAGE/VOLTAJE

⚡ kW kcal/h
400V~3N
50/60 Hz

PREZZO/PRICE €
PREIS/PRIX/PRECIO €
KG / M³

CF4-98ET
09660830

CUCINA 4 piastre - Forno elettrico statico cm. 67x73x34h, temp: 50÷300°C, con 1 griglia cm.65x71 GN2/1 (inclusa 1 testata chiusura piano mod.TPA-9)
EN Electric range - N. 4 plates Traditional electric oven cm. 67x73x34h, temp: 50÷300°C, with 1 grid cm.65x71 GN2/1 (included 1 Head end filler strip mod.TPA-9) • **DE** Elektroherd - N. 4 Kochplatten Statischer Elektro-Backofen cm. 67x73x34h, temp: 50÷300°C, mit 1 Rost cm.65x71 GN2/1 (inbegriffen 1 Abschluss-Element mod.TPA-9) • **FR** Fourneau électrique - N. 4 plaques Four électrique statique cm. 67x73x34h, temp: 50÷300°C, avec 1 grille cm.65x71 GN2/1 (inclus 1 Élément de jonction top mod.TPA-9) • **ES COCINA ELÉCTRICA - N. 4 PLANCHAS HORNO ELÉCTRICO ESTÁTICO CM. 67X73X34H, TEMP: 50÷300 °C, CON 1 PARILLA CM.65X71 GN2/1 (INCLUIDA 1 CHAPA DE CIERRE PARA TOP MOD.TPA-9) cm. 80x 90x 90h**



⚡ 20,7 kW
400V~3N
50/60 Hz

5.548,00
142 / 0,89

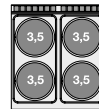

CFV4-98ET
09660835

CUCINA 4 piastre - Forno elettrico ventilato cm. 55x36x34h, temp: 50÷300°C, con 1 griglia cm.53x32,5 GN1/1 (inclusa 1 testata chiusura piano mod.TPA-9)
EN Electric range - N. 4 plates - electric fan oven cm. 55x36x34h, temp: 50÷300°C, with 1 grid cm.53x32,5 GN1/1 (included 1 Head end filler strip mod.TPA-9) • **DE** Elektroherd - N. 4 Kochplatten - Elektro-Heißluftofen cm. 55x36x34h, temp: 50÷300°C, mit 1 Rost cm.53x32,5 GN1/1 (inbegriffen 1 Abschluss-Element mod.TPA-9) • **FR** Fourneau électrique - N. 4 plaques Four à chaleur tournante électrique cm. 55x36x34h, temp: 50÷300°C, avec 1 grille cm.53x32,5 GN1/1 (inclus 1 Élément de jonction top mod.TPA-9) • **ES COCINA ELÉCTRICA - N. 4 PLANCHAS - HORNO ELÉCTRICO VENTILADO CM. 55X36X34H, TEMP: 50÷300 °C, CON 1 PARILLA CM.53X32,5 GN1/1 (INCLUIDA 1 CHAPA DE CIERRE PARA TOP MOD.TPA-9) cm. 80x 90x 90h**

⚡ 19,32 kW
400V~3N
50/60 Hz

6.024,00
142 / 0,89

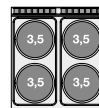

CFQ4-98ET
09660831

CUCINA 4 piastre quadre - Forno elettrico statico cm. 67x73x34h, temp: 50÷300°C, con 1 griglia cm.65x71 GN2/1 (inclusa 1 testata chiusura piano mod.TPA-9)
EN Electric range - N. 4 square plates Traditional electric oven cm. 67x73x34h, temp: 50÷300°C, with 1 grid cm.65x71 GN2/1 (included 1 Head end filler strip mod.TPA-9) • **DE** Elektroherd - N. 4 quadratischen Platten - Statischer Elektro-Backofen cm. 67x73x34h, temp: 50÷300°C, mit 1 Rost cm.65x71 GN2/1 (inbegriffen 1 Abschluss-Element mod.TPA-9) • **FR** Fourneau électrique - N. 4 plaques carrés - Four électrique statique cm. 67x73x34h, temp: 50÷300°C, avec 1 grille cm.65x71 GN2/1 (inclus 1 Élément de jonction top mod.TPA-9) • **ES COCINA ELÉCTRICA - N. 4 PLANCHAS CUADRADAS HORNO ELÉCTRICO ESTÁTICO CM. 67X73X34H, TEMP: 50÷300 °C, CON 1 PARILLA CM.65X71 GN2/1 (INCLUIDA 1 CHAPA DE CIERRE PARA TOP MOD.TPA-9) cm. 80x 90x 90h**



⚡ 22,7 kW
400V~3N
50/60 Hz

6.706,00
150 / 0,89



CFVQ4-98ET
09660836

CUCINA 4 piastre quadre - Forno elettrico ventilato cm. 55x36x34h, temp: 50÷300°C, con 1 griglia cm.53x32,5 GN1/1 (inclusa 1 testata chiusura piano mod.TPA-9)
EN Electric range - N. 4 square plates - electric fan oven cm. 55x36x34h, temp: 50÷300°C, with 1 grid cm.53x32,5 GN1/1 (included 1 Head end filler strip mod.TPA-9) • **DE** Elektroherd - N. 4 quadratischen Platten - Elektro-Heißluftofen cm. 55x36x34h, temp: 50÷300°C, mit 1 Rost cm.53x32,5 GN1/1 (inbegriffen 1 Abschluss-Element mod.TPA-9) • **FR** Fourneau électrique - N. 4 plaques carrés - Four à chaleur tournante électrique cm. 55x36x34h, temp: 50÷300°C, avec 1 grille cm.53x32,5 GN1/1 (inclus 1 Élément de jonction top mod.TPA-9) • **ES COCINA ELÉCTRICA - N. 4 PLANCHAS CUADRADAS HORNO ELÉCTRICO VENTILADO CM. 55X36X34H, TEMP: 50÷300 °C, CON 1 PARILLA CM.53X32,5 GN1/1 (INCLUIDA 1 CHAPA DE CIERRE PARA TOP MOD.TPA-9) cm. 80x 90x 90h**

⚡ 21,32 kW
400V~3N
50/60 Hz

7.182,00
150 / 0,89



CUCINE ELETTRICHE

MOD. _____
COD. _____

DESCRIZIONE/DESCRIPTION/BEZEICHNUNG/DESCRIPTION/DESCRIPCIÓN
DIMENSIONI/DIMENSIONS/ABMESSUNGEN/DIMENSIONS/DIMENSIONES

POTENZA/POWER/LEISTUNG/PUISSANCE/POTENCIA
VOLTAGGIO/VOLTAGE/SPANNUNG/VOLTAGE/VOLTAJE

⚡ kW kcal/h
V~ Hz

PREZZO/PRICE €
PREIS/PRIX/PRECIO €
KG / M³

CFC4-98ET
09660832

CUCINA 4 piastre vetroceramica cm. 75 x 75 - Forno elettrico statico cm. 67x73x34h, temp: 50÷300°C, con 1 griglia cm.65x71 GN2/1 (inclusa 1 testata chiusura piano mod.TPA-9)

EN Electric range N. 4 plates ceramic glass cm. 75 x 75 - traditional electric oven cm. 67x73x34h, temp: 50÷300°C, with 1 grid cm.65x71 GN2/1 (included 1 Head end filler strip mod.TPA-9) • **DE** Elektroherd N. 4 Ceran-Kochplatten cm. 75 x 75 - Statischer Elektro-Backofen cm. 67x73x34h, temp: 50÷300°C, mit 1 Rost cm.65x71 GN2/1 (inbegriffen 1 Abschluss-Element mod.TPA-9) • **FR** Fourneau électrique N. 4 plaques vitroceramique cm. 75 x 75 - Four électrique statique cm. 67x73x34h, temp: 50÷300°C, avec 1 grille cm.65x71 GN2/1 (inclus 1 Elément de jonction top mod.TPA-9) • **ES COCINA ELÉCTRICA N. 4 PLANCHAS VITROCERÁMICA CM. 75 X 75 - HORNO ELÉCTRICO ESTÁTICO CM. 67X73X34H, TEMP: 50÷300°C, CON 1 PARILLA CM.65X71 GN2/1 (INCLUIDA 1 CHAPA DE CIERRE PARA TOP MOD.TPA-9)**
cm. 80x 90x 90h



⚡ 20,3 kW
400V~3N
50/60 Hz

7.413,00
130 / 0,89

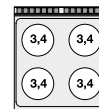

CFVC4-98ET
09660837

CUCINA 4 piastre vetroceramica cm. 75 x 75 - Forno elettrico ventilato cm. 55x36x34h, temp: 50÷300°C, con 1 griglia cm.53x32,5 GN1/1 (inclusa 1 testata chiusura piano mod.TPA-9)

EN Electric range N. 4 plates ceramic glass cm. 75 x 75 - electric fan oven cm. 55x36x34h, temp: 50÷300°C, with 1 grid cm.53x32,5 GN1/1 (included 1 Head end filler strip mod.TPA-9) • **DE** Elektroherd N. 4 Ceran-Kochplatten cm. 75 x 75 - Elektro-Heißluftofen cm. 55x36x34h, temp: 50÷300°C, mit 1 Rost cm.53x32,5 GN1/1 (inbegriffen 1 Abschluss-Element mod.TPA-9) • **FR** Fourneau électrique N. 4 plaques vitroceramique cm. 75 x 75 - Four à chaleur tournante électrique cm. 55x36x34h, temp: 50÷300°C, avec 1 grille cm.53x32,5 GN1/1 (inclus 1 Elément de jonction top mod.TPA-9) • **ES COCINA ELÉCTRICA N. 4 PLANCHAS VITROCERÁMICA CM. 75 X 75 - HORNO ELÉCTRICO VENTILADO CM. 55X36X34H, TEMP: 50÷300°C, CON 1 PARILLA CM.53X32,5 GN1/1 (INCLUIDA 1 CHAPA DE CIERRE PARA TOP MOD.TPA-9)**
cm. 80x 90x 90h

⚡ 18,92 kW
400V~3N
50/60 Hz

7.889,00
130 / 0,89

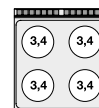

CF4-98G
09680850

CUCINA 4 fuochi - Forno a gas statico cm. 67x73x34h, temp: 150÷300°C, con 1 griglia cm.65x71 GN2/1 (inclusa 1 testata chiusura piano mod.TPC-9)

EN Gas Range - N. 4 burners Traditional gas-oven cm. 67x73x34h, temp: 150÷300°C, with 1 grid cm.65x71 GN2/1 (included 1 Head end filler strip mod.TPC-9) • **DE** Gashernd - N. 4 Kochstellen Statischer Gas-Backofen cm. 67x73x34h, temp: 150÷300°C, mit 1 Rost cm.65x71 GN2/1 (inbegriffen 1 Abschluss-Element mod.TPC-9) • **FR** Cuisiniere gaz - N. 4 feux vifs Four à gaz statique cm. 67x73x34h, temp: 150÷300°C, avec 1 grille cm.65x71 GN2/1 (inclus 1 Elément de jonction top mod.TPC-9) • **ES COCINA A GAS - N. 4 QUEMADORES HORNO A GAS ESTÁTICO CM. 67X73X34H, TEMP: 150÷300°C, CON 1 PARILLA CM.65X71 GN2/1 (INCLUIDA 1 CHAPA DE CIERRE PARA TOP MOD.TPC-9)**
cm. 80x 90x 90h



⚡ 36,5 kW
31.390 kcal/h

5.133,00
166 / 0,89

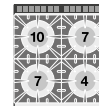

CF4-98GE
09690860

CUCINA 4 fuochi - Forno elettrico statico cm. 67x73x34h, temp: 50÷300°C, con 1 griglia cm.65x71 GN2/1 (inclusa 1 testata chiusura piano mod.TPC-9)

EN Gas Range - N. 4 burners - traditional electric oven cm. 67x73x34h, temp: 50÷300°C, with 1 grid cm.65x71 GN2/1 (included 1 Head end filler strip mod.TPC-9) • **DE** Gashernd - N. 4 Kochstellen Statischer Elektro-Backofen cm. 67x73x34h, temp: 50÷300°C, mit 1 Rost cm.65x71 GN2/1 (inbegriffen 1 Abschluss-Element mod.TPC-9) • **FR** Cuisiniere gaz - N. 4 feux vifs Four électrique statique cm. 67x73x34h, temp: 50÷300°C, avec 1 grille cm.65x71 GN2/1 (inclus 1 Elément de jonction top mod.TPC-9) • **ES COCINA A GAS - N. 4 QUEMADORES HORNO ELÉCTRICO ESTÁTICO CM. 67X73X34H, TEMP: 50÷300°C, CON 1 PARILLA CM.65X71 GN2/1 (INCLUIDA 1 CHAPA DE CIERRE PARA TOP MOD.TPC-9)**
cm. 80x 90x 90h



⚡ 28 kW
24.080 kcal/h

5.236,00
164 / 0,89

⚡ 6,7 kW
400V~3N
50/60 Hz

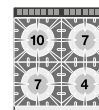

CUCINE A GAS CON FORNO ELETTRICO

MOD. _____
COD. _____

DESCRIZIONE/DESCRIPTION/BEZEICHNUNG/DESCRIPTION/DESCRIPCIÓN
DIMENSIONI/DIMENSIONS/ABMESSUNGEN/DIMENSIONS/DIMENSIONES

POTENZA/POWER/LEISTUNG/PUISSANCE/POTENCIA
VOLTAGGIO/VOLTAGE/SPANNUNG/VOLTAGE/VOLTAJE

⚡ kW _____
kcal/h _____
V~ _____
Hz _____

PREZZO/PRICE _____ €
PREIS/PRICE/PRECIO _____
KG / M³

CFV4-98GE
09690865

CUCINA 4 fuochi - Forno elettrico ventilato cm. 55x36x34h, temp: 50÷300°C, con 1 griglia cm.53x32,5 GN1/1 (inclusa 1 testata chiusura piano mod.TPC-9)
EN Gas Range - N. 4 burners - electric fan oven cm. 55x36x34h, temp: 50÷300°C, with 1 grid cm.53x32,5 GN1/1 (included 1 Head end filler strip mod.TPC-9) • **DE** Gasherd - N. 4 Kochstellen Elektro-Heißluftofen cm. 55x36x34h, temp: 50÷300°C, mit 1 Rost cm.53x32,5 GN1/1 (inbegriffen 1 Abschluss-Element mod.TPC-9) • **FR** Cuisiniere gaz - N. 4 feux vifs Four à chaleur tournante électrique cm. 55x36x34h, temp: 50÷300°C, avec 1 grille cm.53x32,5 GN1/1 (inclus 1 Élément de jonction top mod.TPC-9) • **ES COCINA A GAS - N. 4 QUEMADORES HORNO ELÉCTRICO VENTILADO CM. 55X36X34H, TEMP: 50÷300°C, CON 1 PARILLA CM.53X32,5 GN1/1 (INCLUIDA 1 CHAPA DE CIERRE PARA TOP MOD.TPC-9)**
cm. 80x 90x 90h



⚡ 28 kW _____ **5.705,00**
24.080 kcal/h 164 / 0,89

⚡ 5,32 kW _____
400V~3N _____
230V~3 _____
50/60 Hz _____



CFA4-98G
09750850

CUCINA ACQUA 4 fuochi - Forno a gas statico cm. 67x73x34h, temp: 150÷300°C, con 1 griglia cm.65x71 GN2/1 - Rubinetto carico acqua, sfioratore (inclusa 1 testata chiusura piano mod.TPA-9)
EN Water range - N. 4 burners Traditional gas-oven cm. 67x73x34h, temp: 150÷300°C, with 1 grid cm.65x71 GN2/1 - Water loading tap + overflow device (included 1 Head end filler strip mod.TPA-9) • **DE** Wasser herd - N. 4 Kochstellen Statischer Gas-Backofen cm. 67x73x34h, temp: 150÷300°C, mit 1 Rost cm.65x71 GN2/1 - Wasserlauf-Hahn + Überlauf-Vorrichtung (inbegriffen 1 Abschluss-Element mod.TPA-9) • **FR** Cuisinière l'eau - N. 4 feux vifs Four à gaz statique cm. 67x73x34h, temp: 150÷300°C, avec 1 grille cm.65x71 GN2/1 - Robinet d'arrivée d'eau trop plein (inclus 1 Élément de jonction top mod.TPA-9) • **ES COCINA A AGUA - N. 4 QUEMADORES HORNO A GAS ESTÁTICO CM. 67X73X34H, TEMP: 150÷300°C, CON 1 PARILLA CM.65X71 GN2/1 - GRIFO CARGA AGUA + VERTEDERO (INCLUIDA 1 CHAPA DE CIERRE PARA TOP MOD.TPA-9)**
cm. 80x 90x 90h



⚡ 36,5 kW _____ **6.742,00**
31.390 kcal/h 166 / 0,89



CF6-912EV
09661230

CUCINA 6 piastre - Forno elettrico statico cm. 67x73x34h, temp: 50÷300°C, con 1 griglia cm.65x71 GN2/1 - Vano neutro con porta (inclusa 1 testata chiusura piano mod.TPA-9)
EN Electric range - N. 6 plates Traditional electric oven cm. 67x73x34h, temp: 50÷300°C, with 1 grid cm.65x71 GN2/1 - Neutral cabinet with door (included 1 Head end filler strip mod.TPA-9) • **DE** Elektroherd - N. 6 Kochplatten Statischer Elektro-Backofen cm. 67x73x34h, temp: 50÷300°C, mit 1 Rost cm.65x71 GN2/1 - Neutrales Schrankelement mit Tür (inbegriffen 1 Abschluss-Element mod.TPA-9) • **FR** Fourneau électrique - N. 6 plaques Four électrique statique cm. 67x73x34h, temp: 50÷300°C, avec 1 grille cm.65x71 GN2/1 - Element neutre avec porte (inclus 1 Élément de jonction top mod.TPA-9) • **ES COCINA ELÉCTRICA - N. 6 PLANCHAS HORNO ELÉCTRICO ESTÁTICO CM. 67X73X34H, TEMP: 50÷300°C, CON 1 PARILLA CM.65X71 GN2/1 - ARMARIO NEUTRO CON PUERTA (INCLUIDA 1 CHAPA DE CIERRE PARA TOP MOD.TPA-9)**
cm. 120x 90x 90h



⚡ 27,7 kW _____ **7.306,00**
400V~3N _____ 200 / 1,32
50/60 Hz _____

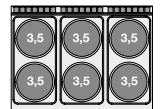

CFV6-912EV
09661235

CUCINA 6 piastre - Forno elettrico ventilato cm. 55x36x34h, temp: 50÷300°C, con 1 griglia cm.53x32,5 GN1/1 - Vano neutro con porta (inclusa 1 testata chiusura piano mod.TPA-9)
EN Electric range - N. 6 plates electric fan oven cm. 55x36x34h, temp: 50÷300°C, with 1 grid cm.53x32,5 GN1/1 - Neutral cabinet with door (included 1 Head end filler strip mod.TPA-9) • **DE** Elektroherd - N. 6 Kochplatten Elektro-Heißluftofen cm. 55x36x34h, temp: 50÷300°C, mit 1 Rost cm.53x32,5 GN1/1 - Neutrales Schrankelement mit Tür (inbegriffen 1 Abschluss-Element mod.TPA-9) • **FR** Fourneau électrique - N. 6 plaques Four à chaleur tournante électrique cm. 55x36x34h, temp: 50÷300°C, avec 1 grille cm.53x32,5 GN1/1 - Element neutre avec porte (inclus 1 Élément de jonction top mod.TPA-9) • **ES COCINA ELÉCTRICA - N. 6 PLANCHAS HORNO ELÉCTRICO VENTILADO CM. 55X36X34H, TEMP: 50÷300°C, CON 1 PARILLA CM.53X32,5 GN1/1 - ARMARIO NEUTRO CON PUERTA (INCLUIDA 1 CHAPA DE CIERRE PARA TOP MOD. TPA-9)**
cm. 120x 90x 90h

⚡ 26,32 kW _____ **7.782,00**
400V~3N _____ 200 / 1,32
50/60 Hz _____

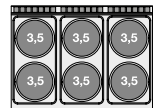

CUCINE ELETTRICHE

MOD. _____
COD. _____

DESCRIZIONE/DESCRIPTION/BEZEICHNUNG/DESCRIPTION/DESCRIPCIÓN
DIMENSIONI/DIMENSIONS/ABMESSUNGEN/DIMENSIONS/DIMENSIONES

POTENZA/POWER/LEISTUNG/PUISSANCE/POTENCIA
VOLTAGGIO/VOLTAGE/SPANNUNG/VOLTAGE/VOLTAJE

⚡ kW kcal/h
⚡ kW V~ Hz

PREZZO/PRICE €
PREIS/PRIX/PRECIO €
KG / M³

CFQ6-912ETV CUCINA 6 piastre quadre - Forno elettrico statico cm. 67x73x34h, temp: 50÷300°C, con 1 griglia cm.65x71 GN2/1 - Vano neutro con porta (inclusa 1 testata chiusura piano mod.TPA-9)

EN Electric range - N. 6 square plates Traditional electric oven cm. 67x73x34h, temp: 50÷300°C, with 1 grid cm.65x71 GN2/1 - Neutral cabinet with door (included 1 Head end filler strip mod.TPA-9) • **DE** Elektroherd - N. 6 quadratischen Platten Statischer Elektro-Backofen cm. 67x73x34h, temp: 50÷300°C, mit 1 Rost cm.65x71 GN2/1 - Neutrales Schrankelement mit Tür (inbegriffen 1 Abschluss-Element mod.TPA-9) • **FR** Fourneau électrique - N. 6 plaques carrés Four électrique statique cm. 67x73x34h, temp: 50÷300°C, avec 1 grille cm.65x71 GN2/1 - Element neutre avec porte (inclus 1 Élément de jonction top mod.TPA-9) • **ES COCINA ELÉCTRICA - N. 6 PLANCHAS CUADRADAS HORNO ELÉCTRICO ESTÁTICO CM. 67X73X34H, TEMP: 50÷300°C, CON 1 PARILLA CM.65X71 GN2/1 - ARMARIO NEUTRO CON PUERTA (INCLUIDA 1 CHAPA DE CIERRE PARA TOP MOD.TPA-9) cm. 120x 90x 90h**



⚡ 30,7 kW **9.237,00**
400V~3N 212 / 1,32
50/60 Hz

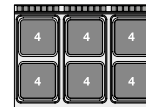

CFVQ6-912ETV CUCINA 6 piastre quadre - Forno elettrico ventilato cm. 55x36x34h, temp: 50÷300°C, con 1 griglia cm.53x32,5 GN1/1 - Vano neutro con porta (inclusa 1 testata chiusura piano mod.TPA-9)

EN Electric range - N. 6 square plates electric fan oven cm. 55x36x34h, temp: 50÷300°C, with 1 grid cm.53x32,5 GN1/1 - Neutral cabinet with door (included 1 Head end filler strip mod.TPA-9) • **DE** Elektroherd - N. 6 quadratischen Platten Elektro-Heißluftofen cm. 55x36x34h, temp: 50÷300°C, mit 1 Rost cm.53x32,5 GN1/1 - Neutrales Schrankelement mit Tür (inbegriffen 1 Abschluss-Element mod.TPA-9) • **FR** Fourneau électrique - N. 6 plaques carrés Four à chaleur tournante électrique cm. 55x36x34h, temp: 50÷300°C, avec 1 grille cm.53x32,5 GN1/1 - Element neutre avec porte (inclus 1 Élément de jonction top mod.TPA-9) • **ES COCINA ELÉCTRICA - N. 6 PLANCHAS CUADRADAS HORNO ELÉCTRICO VENTILADO CM. 55X36X34H, TEMP: 50÷300°C, CON 1 PARILLA CM.53X32,5 GN1/1 - ARMARIO NEUTRO CON PUERTA (INCLUIDA 1 CHAPA DE CIERRE PARA TOP MOD.TPA-9) cm. 120x 90x 90h**

⚡ 29,32 kW **9.714,00**
400V~3N 212 / 1,32
50/60 Hz

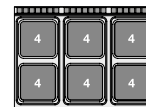

CF6-912ET CUCINA 6 piastre Forno elettrico statico cm. 107x73x34h, temp: 50÷300°C, con 1 griglia cm.105x71 (inclusa 1 testata chiusura piano mod.TPA-9)

EN Electric Range - N. 6 plates Traditional electric oven cm. 107x73x34h, temp: 50÷300°C, with 1 grid cm.105x71 (included 1 Head end filler strip mod.TPA-9) • **DE** Elektroherd - N. 6 Kochplatten Statischer Elektro-Backofen cm. 107x73x34h, temp: 50÷300°C, mit 1 Rost cm.105x71 (inbegriffen 1 Abschluss-Element mod.TPA-9) • **FR** Fourneau électrique - N. 6 plaques Four électrique statique cm. 107x73x34h, temp: 50÷300°C, avec 1 grille cm.105x71 (inclus 1 Élément de jonction top mod.TPA-9) • **ES COCINA ELÉCTRICA - N. 6 PLANCHAS HORNO ELÉCTRICO ESTÁTICO CM. 107X73X34H, TEMP: 50÷300°C, CON 1 PARILLA CM.105X71 (INCLUIDA 1 CHAPA DE CIERRE PARA TOP MOD.TPA-9) cm. 120x 90x 90h**



⚡ 30,2 kW **7.917,00**
400V~3N 206 / 1,32
50/60 Hz

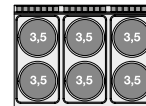

CFQ6-912ET CUCINA 6 piastre quadre Forno elettrico statico cm. 107x73x34h, temp: 50÷300°C, con 1 griglia cm.105x71 (inclusa 1 testata chiusura piano mod.TPA-9)

EN Electric Range - N. 6 square plates Traditional electric oven cm. 107x73x34h, temp: 50÷300°C, with 1 grid cm.105x71 (included 1 Head end filler strip mod.TPA-9) • **DE** Elektroherd - N. 6 quadratischen Platten Statischer Elektro-Backofen cm. 107x73x34h, temp: 50÷300°C, mit 1 Rost cm.105x71 (inbegriffen 1 Abschluss-Element mod.TPA-9) • **FR** Fourneau électrique - N. 6 plaques carrés Four électrique statique cm. 107x73x34h, temp: 50÷300°C, avec 1 grille cm.105x71 (inclus 1 Élément de jonction top mod.TPA-9) • **ES COCINA ELÉCTRICA - N. 6 PLANCHAS CUADRADAS HORNO ELÉCTRICO ESTÁTICO CM. 107X73X34H, TEMP: 50÷300°C, CON 1 PARILLA CM.105X71 (INCLUIDA 1 CHAPA DE CIERRE PARA TOP MOD.TPA-9) cm. 120x 90x 90h**



⚡ 33,2 kW **9.841,00**
400V~3N 218 / 1,32
50/60 Hz



CUCINE A GAS

MOD. _____
COD. _____

DESCRIZIONE/DESCRIPTION/BEZEICHNUNG/DESCRIPTION/DESCRIPCIÓN
DIMENSIONI/DIMENSIONS/ABMESSUNGEN/DIMENSIONS/DIMENSIONES

POTENZA/POWER/LEISTUNG/PUISSANCE/POTENCIA
VOLTAGGIO/VOLTAGE/SPANNUNG/VOLTAGE/VOLTAJE

⚡ kW kcal/h
⚡ kW V- Hz

PREZZO/PRICE €
PREIS/PRIX/PRECIO €
KG / M³

CF6-912GV CUCINA 6 fuochi Forno a gas statico cm. 67x73x34h, temp: 150÷300°C, con 1 griglia cm.65x71 GN2/1 - Vano neutro con porta (inclusa 1 testata chiusura piano mod.TPC-9)
EN Gas Range - N. 6 burners Traditional gas-oven GN cm. 67x73x34h, temp: 150÷300°C, with 1 grid cm.65x71 GN2/1 - Neutral cabinet with door (included 1 Head end filler strip mod.TPC-9) • **DE** Gasherd - N. 6 Kochstellen - Statischer Gas-Backofen cm. 67x73x34h, temp: 150÷300°C, mit 1 Rost cm.65x71 GN2/1 - Neutrales Schrankelement mit Tür (inbegriffen 1 Abschluss-Element mod.TPC-9) • **FR** Cuisiniere Gaz - N. 6 feux vifs Four à gaz statique cm. 67x73x34h, temp: 150÷300°C, avec 1 grille cm.65x71 GN2/1 - Elément neutre avec porte (inclus 1 Elément de jonction top mod.TPC-9) • **ES COCINA A GAS - N. 6 QUEMADORES HORNO A GAS ESTÁTICO CM. 67X73X34H, TEMP: 150÷300°C, CON 1 PARILLA CM.65X71 GN2/1 - ARMARIO NEUTRO CON PUERTA (INCLUIDA 1 CHAPA DE CIERRE PARA TOP MOD.TPC-9)**
cm. 120x 90x 90h



⚡ 53,5 kW 6.955,00
46.010 kcal/h 230 / 1,32

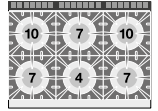

CF6-912GEV CUCINA 6 fuochi - Forno elettrico statico cm. 67x73x34h, temp: 50÷300°C, con 1 griglia cm.65x71 GN2/1 - Vano neutro con porta (inclusa 1 testata chiusura piano mod.TPC-9)
EN Gas Range - N. 6 burners - traditional electric oven cm. 67x73x34h, temp: 50÷300°C, with 1 grid cm.65x71 GN2/1 - Neutral cabinet with door (included 1 Head end filler strip mod.TPC-9) • **DE** Gasherd - N. 6 Kochstellen Statischer Elektro-Backofen cm. 67x73x34h, temp: 50÷300°C, mit 1 Rost cm.65x71 GN2/1 - Neutrales Schrankelement mit Tür (inbegriffen 1 Abschluss-Element mod.TPC-9) • **FR** Cuisiniere gaz - N. 6 feux vifs Four électrique statique cm. 67x73x34h, temp: 50÷300°C, avec 1 grille cm.65x71 GN2/1 - Element neutre avec porte (inclus 1 Elément de jonction top mod.TPC-9) • **ES COCINA A GAS - N. 6 QUEMADORES HORNO ELÉCTRICO ESTÁTICO CM. 67X73X34H, TEMP: 50÷300°C, CON 1 PARILLA CM.65X71 GN2/1 - ARMARIO NEUTRO CON PUERTA (INCLUIDA 1 CHAPA DE CIERRE PARA TOP MOD.TPC-9)**
cm. 120x 90x 90h



⚡ 45 kW 7.080,00
38.700 kcal/h 228 / 1,32

⚡ 6,7 kW
400V~3N
50/60 Hz

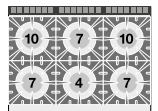

CFV6-912GEV CUCINA 6 fuochi - Forno elettrico ventilato cm. 55x36x34h, temp: 50÷300°C, con 1 griglia cm.53x32,5 GN1/1 - Vano neutro con porta (inclusa 1 testata chiusura piano mod.TPC-9)
EN Gas Range - N. 6 burners - electric fan oven cm. 55x36x34h, temp: 50÷300°C, with 1 grid cm.53x32,5 GN1/1 - Neutral cabinet with door (included 1 Head end filler strip mod.TPC-9) • **DE** Gas Range - N. 6 burners - electric fan oven cm. 55x36x34h, temp: 50÷300°C, mit 1 Rost cm.53x32,5 GN1/1 - Neutral cabinet with door (inbegriffen 1 Abschluss-Element mod.TPC-9) • **FR** Gas Range - N. 6 burners - electric fan oven cm. 55x36x34h, temp: 50÷300°C, avec 1 grille cm.53x32,5 GN1/1 - Neutral cabinet with door (inclus 1 Elément de jonction top mod.TPC-9) • **ES GAS RANGE - N. 6 BURNERS - ELECTRIC FAN OVEN CM. 55X36X34H, TEMP: 50÷300°C, CON 1 PARILLA CM.53X32,5 GN1/1 - NEUTRAL CABINET WITH DOOR (INCLUIDA 1 CHAPA DE CIERRE PARA TOP MOD.TPC-9)**
cm. 120x 90x 90h

⚡ 45 kW 7.557,00
38.700 kcal/h 228 / 1,32

⚡ 5,32 kW
400V~3N
230V~3
50/60 Hz

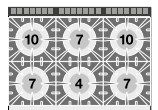

CFA6-912GV CUCINA ACQUA 6 fuochi - Forno a gas statico cm. 67x73x34h, temp: 150÷300°C, con 1 griglia cm.65x71 GN2/1 - Vano neutro con porta - Rubinetto carico acqua, sfioratore (inclusa 1 testata chiusura piano mod.TPA-9)
EN Water range - N. 6 burners - Traditional gas-oven cm. 67x73x34h, temp: 150÷300°C, with 1 grid cm.65x71 GN2/1 - Neutral cabinet with door - Water loading tap + overflow device (included 1 Head end filler strip mod.TPA-9) • **DE** Wasser herd - N. 6 Kochstellen - Statischer Gas-Backofen cm. 67x73x34h, temp: 150÷300°C, mit 1 Rost cm.65x71 GN2/1 - Neutrales Schrankelement mit Tür - Wasserlauf-Hahn + Überlauf-Vorrichtung (inbegriffen 1 Abschluss-Element mod.TPA-9) • **FR** Cuisiniere l'eau - N. 6 feux vifs Four à gaz statique cm. 67x73x34h, temp: 150÷300°C, avec 1 grille cm.65x71 GN2/1 - Element neutre avec porte - Robinet d'arrivée d'eau trop plein (inclus 1 Elément de jonction top mod.TPA-9) • **ES COCINA A AGUA N. 6 QUEMADORES HORNO A GAS ESTÁTICO CM. 67X73X34H, TEMP: 150÷300°C, CON 1 PARILLA CM.65X71 GN2/1 - ARMARIO NEUTRO CON PUERTA - GRIFO CARGA AGUA + VERTEDERO (INCLUIDA 1 CHAPA DE CIERRE PARA TOP MOD.TPA-9)**
cm. 120x 90x 90h



⚡ 50,5 kW 8.800,00
43.430 kcal/h 230 / 1,32

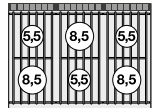

CUCINE A GAS

MOD. _____
COD.

DESCRIZIONE/DESCRIPTION/BEZEICHNUNG/DESCRIPTION/DESCRIPCIÓN
DIMENSIONI/DIMENSIONS/ABMESSUNGEN/DIMENSIONS/DIMENSIONES

POTENZA/POWER/LEISTUNG/PUISSANCE/POTENCIA
VOLTAGGIO/VOLTAGE/SPANNUNG/VOLTAGE/VOLTAJE

⚡ kW
kcal/h

⚡ kW
V~
Hz

PREZZO/PRICE €
PREIS/PRIX/PRECIO €
KG / M³

CF6-912G
09681250

CUCINA 6 fuochi Forno a gas statico cm. 107x73x34h, temp: 150÷300°C, con 1 griglia cm.105x71 (inclusa 1 testata chiusura piano mod.TPC-9)

EN Gas Range - N. 6 burners Traditional gas-oven cm. 107x73x34h, temp: 150÷300°C, with 1 grid cm.105x71 (included 1 Head end filler strip mod.TPC-9) • **DE** Gashernd - N. 6 Kochstellen Statischer Gas-Backofen cm. 107x73x34h, temp: 150÷300°C, mit 1 Rost cm.105x71 (inbegriffen 1 Abschluss-Element mod.TPC-9) • **FR** Cuisiniere gaz - N. 6 feux vifs Four à gaz statique cm. 107x73x34h, temp: 150÷300°C, avec 1 grille cm.105x71 (inclus 1 Élément de jonction top mod.TPC-9) • **ES COCINA A GAS - N. 6 QUEMADORES HORNO A GAS ESTÁTICO CM. 107X73X34H, TEMP: 150÷300°C, CON 1 PARILLA CM.105X71 (INCLUIDA 1 CHAPA DE CIERRE PARA TOP MOD.TPC-9)**
cm. 120x 90x 90h



⚡ 58 kW
49.820 kcal/h

7.480,00
236 / 1,32

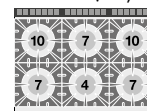

CF6-912GE
09691260

CUCINA 6 fuochi Forno elettrico statico cm. 107x73x34h, temp: 50÷300°C, con 1 griglia cm.105x71 (inclusa 1 testata chiusura piano mod.TPC-9)

EN Gas Range - N. 6 burners Traditional electric oven cm. 107x73x34h, temp: 50÷300°C, with 1 grid cm.105x71 (included 1 Head end filler strip mod.TPC-9) • **DE** Gashernd - N. 6 Kochstellen Statischer Elektro-Backofen cm. 107x73x34h, temp: 50÷300°C, mit 1 Rost cm.105x71 (inbegriffen 1 Abschluss-Element mod.TPC-9) • **FR** Cuisiniere gaz - N. 6 feux vifs Four électrique statique cm. 107x73x34h, temp: 50÷300°C, avec 1 grille cm.105x71 (inclus 1 Élément de jonction top mod.TPC-9) • **ES COCINA A GAS - N. 6 QUEMADORES HORNO ELÉCTRICO ESTÁTICO CM. 107X73X34H, TEMP: 50÷300°C, CON 1 PARILLA CM.105X71 (INCLUIDA 1 CHAPA DE CIERRE PARA TOP MOD.TPC-9)**
cm. 120x 90x 90h



⚡ 45 kW
38.700 kcal/h

7.619,00
230 / 1,32

⚡ 9,2 kW
400V~3N
50/60 Hz

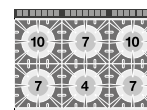

CF8-916G
09681650

CUCINA 8 fuochi - 2 Forni gas statici cm. 67x73x34h, temp: 150÷300°C, con 2 griglie cm.65x71 GN2/1 (inclusa 1 testata chiusura piano mod.TPC-9)

EN Gas Range - N. 8 burners - 2 Traditional gas-oven cm. 67x73x34h, temp: 150÷300°C, with 2 grids cm.65x71 GN2/1 (included 1 Head end filler strip mod.TPC-9) • **DE** Gashernd - N. 8 Kochstellen - 2 Statischer Gas-Backofen cm. 67x73x34h, temp: 150÷300°C, mit 2 Rost cm.65x71 GN2/1 (inbegriffen 1 Abschluss-Element mod.TPC-9) • **FR** Cuisiniere gaz - N. 8 feux - 2 Four à gaz statique cm. 67x73x34h, temp: 150÷300°C, avec 2 grille cm.65x71 GN2/1 (inclus 1 Élément de jonction top mod.TPC-9) • **ES COCINA A GAS - N. 8 QUEMADORES - 2 HORNO A GAS ESTÁTICO CM. 67X73X34H, TEMP: 150÷300°C, CON 2 PARILLA CM.65X71 GN2/1 (INCLUIDA 1 CHAPA DE CIERRE PARA TOP MOD.TPC-9)**
cm. 160x 90x 90h



⚡ 73 kW
62.780 kcal/h

10.227,00
318 / 1,76

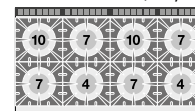

PC-94ET
09030430

PIANO COTTURA TRIFASE SU MOBILE A GIORNO - N. 2 piastre (inclusa 1 testata chiusura piano mod.TPA-9)

EN Boiling unit threephase on open cabinet - N. 2 plates (included 1 Head end filler strip mod.TPA-9) • **DE** Kochplatte dreiphasig mit offenem Unterbau - N. 2 Kochplatten (inbegriffen 1 Abschluss-Element mod.TPA-9) • **FR** Rechaud électriques sur armoire ouvert - N. 2 plaques (inclus 1 Élément de jonction top mod.TPA-9) • **ES SOBRE DE COCCIÓN TRIFÁSICO SOBRE MUEBLE ABIERTO - N. 2 PLANCHAS (INCLUIDA 1 CHAPA DE CIERRE PARA TOP MOD.TPA-9)**
cm. 40x 90x 90h



⚡ 7,0 kW
400V~2N
230V~3
230V~
50/60 Hz

1.865,00
53 / 0,46



PC-98ET
09030830

PIANO COTTURA TRIFASE SU MOBILE A GIORNO N. 4 piastre (inclusa 1 testata chiusura piano mod.TPA-9)

EN Threephase boiling unit on open cabinet - N. 4 plates (included 1 Head end filler strip mod.TPA-9) • **DE** Kochplatte dreiphasig mit offenem Unterbau N. 4 Kochplatten (inbegriffen 1 Abschluss-Element mod.TPA-9) • **FR** Rechaud triphase sur armoire ouvert - N. 4 plaques (inclus 1 Élément de jonction top mod.TPA-9) • **ES SOBRE DE COCCIÓN TRIFÁSICO SOBRE MUEBLE ABIERTO N. 4 PLANCHAS (INCLUIDA 1 CHAPA DE CIERRE PARA TOP MOD.TPA-9)**
cm. 80x 90x 90h



⚡ 14,0 kW
400V~3N
50/60 Hz

3.458,00
86 / 0,89



PIANI COTTURA ELETTRICI

MOD. _____
COD. _____

DESCRIZIONE/DESCRIPTION/BEZEICHNUNG/DESCRIPTION/DESCRIPCIÓN
DIMENSIONI/DIMENSIONS/ABMESSUNGEN/DIMENSIONS/DIMENSIONES

POTENZA/POWER/LEISTUNG/PUISSANCE/POTENCIA
VOLTAGGIO/VOLTAGE/SPANNUNG/VOLTAGE/VOLTAJE

⚡ kW _____
kcal/h _____
V~ _____
Hz _____

PREZZO/PRICE €
PREIS/PRIX/PRECIO _____
KG / M³

PC-912ET
09031230

PIANO COTTURA TRIFASE SU MOBILE A GIORNO N. 6 piastre (inclusa 1 testata chiusura piano mod.TPA-9)
EN Threephase boiling unit on open cabinet - N. 6 plates (included 1 Head end filler strip mod.TPA-9) • **DE** Kochplatte dreiphasig mit offenem Unterbau N. 6 Kochplatten (inbegriffen 1 Abschluss-Element mod.TPA-9) • **FR** Rechaud triphasé sur armoire ouvert - N. 6 plaques (inclus 1 Élément de jonction top mod.TPA-9) • **ES SOBRE DE COCCIÓN TRIFÁSICO SOBRE MUEBLE ABIERTO N. 6 PLANCHAS (INCLUIDA 1 CHAPA DE CIERRE PARA TOP MOD.TPA-9)**
cm. 120x 90x 90h



⚡ 21,0 kW _____ **4.719,00**
400V~3N _____ 114 / 1,32
50/60 Hz



PCQ-94ET
09030431

PIANO COTTURA TRIFASE SU MOBILE A GIORNO - N. 2 piastre quadre (inclusa 1 testata chiusura piano mod.TPA-9)
EN Boiling unit threephase on open cabinet - N. 2 square plates (included 1 Head end filler strip mod.TPA-9) • **DE** Kochplatte dreiphasig mit offenem Unterbau N. 2 quadratischen Platten (inbegriffen 1 Abschluss-Element mod.TPA-9) • **FR** Rechaud électriques sur armoire ouvert - N. 2 plaques carrés (inclus 1 Élément de jonction top mod.TPA-9) • **ES SOBRE DE COCCIÓN TRIFÁSICO SOBRE MUEBLE ABIERTO N. 2 PLANCHAS CUADRADAS (INCLUIDA 1 CHAPA DE CIERRE PARA TOP MOD.TPA-9)**
cm. 40x 90x 90h



⚡ 8,0 kW _____ **2.458,00**
400V~2N _____ 57 / 0,46
230V~3
230V~
50/60 Hz



PCQ-98ET
09030831

PIANO COTTURA TRIFASE SU MOBILE A GIORNO - N. 4 piastre quadre (inclusa 1 testata chiusura piano mod.TPA-9)
EN Boiling unit threephase on open cabinet - N. 4 square plates (included 1 Head end filler strip mod.TPA-9) • **DE** Kochplatte dreiphasig mit offenem Unterbau N. 4 quadratischen Platten (inbegriffen 1 Abschluss-Element mod.TPA-9) • **FR** Rechaud électriques sur armoire ouvert - N. 4 plaques carrés (inclus 1 Élément de jonction top mod.TPA-9) • **ES SOBRE DE COCCIÓN TRIFÁSICO SOBRE MUEBLE ABIERTO N. 4 PLANCHAS CUADRADAS (INCLUIDA 1 CHAPA DE CIERRE PARA TOP MOD.TPA-9)**
cm. 80x 90x 90h



⚡ 16,0 kW _____ **4.443,00**
400V~3N _____ 94 / 0,89
50/60 Hz



PCQ-912ET
09031231

PIANO COTTURA TRIFASE SU MOBILE A GIORNO - N. 6 piastre quadre (inclusa 1 testata chiusura piano mod.TPA-9)
EN Boiling unit threephase on open cabinet - N. 6 square plates (included 1 Head end filler strip mod.TPA-9) • **DE** Kochplatte dreiphasig mit offenem Unterbau N. 6 quadratischen Platten (inbegriffen 1 Abschluss-Element mod.TPA-9) • **FR** Rechaud électriques sur armoire ouvert - N. 6 plaques carrés (inclus 1 Élément de jonction top mod.TPA-9) • **ES SOBRE DE COCCIÓN TRIFÁSICO SOBRE MUEBLE ABIERTO N. 6 PLANCHAS CUADRADAS (INCLUIDA 1 CHAPA DE CIERRE PARA TOP MOD.TPA-9)**
cm. 120x 90x 90h

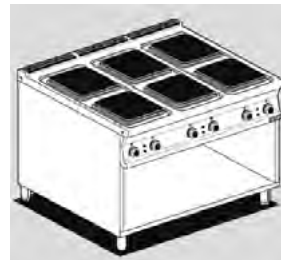

⚡ 24,0 kW _____ **6.118,00**
400V~3N _____ 129 / 1,32
50/60 Hz



PCC-94ET
09030432

PIANO COTTURA VETROCERAMICA TRIFASE su mobile a giorno - N. 2 zone - vetro cm.35x77 (inclusa 1 testata chiusura piano mod.TPA-9)
EN Ceramic glass boiling unit on open cabinet - n. 2 zones - glass cm.35x77 (included 1 Head end filler strip mod.TPA-9) • **DE** Ceran-Kochplatte dreiphasig mit offenem Unterbau - 2 zonen - Glas 35x77 cm (inbegriffen 1 Abschluss-Element mod.TPA-9) • **FR** Plan de cuisson à vitroceramique triphasé sur armoire ouvert N. 2 zones - Verre cm.35x77 (inclus 1 Élément de jonction top mod.TPA-9) • **ES SOBRE DE COCCIÓN TRIFÁSICO VITROCERÁMICA SOBRE MUEBLE ABIERTO - 2 ZONAS - VIDRO CM.35X77 (INCLUIDA 1 CHAPA DE CIERRE PARA TOP MOD.TPA-9)**
cm. 40x 90x 90h



⚡ 6,8 kW _____ **3.120,00**
400V~2N _____ 48 / 0,46
230V~3
230V~
50/60 Hz

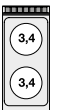

PCC-98ET
09030832

PIANO COTTURA VETROCERAMICA TRIFASE su mobile a giorno - N. 4 zone - vetro cm. 75x77 (inclusa 1 testata chiusura piano mod.TPA-9)
EN Ceramic glass boiling unit on open cabinet - n. 4 zones - glass cm. 75 x 77 (included 1 Head end filler strip mod.TPA-9) • **DE** Ceran-Kochplatte dreiphasig mit offenem Unterbau - 4 zonen - Glas 75x77 cm (inbegriffen 1 Abschluss-Element mod.TPA-9) • **FR** Plan de cuisson à vitroceramique triphasé sur armoire ouvert N. 4 zones - Verre cm 75x77 (inclus 1 Élément de jonction top mod.TPA-9) • **ES SOBRE DE COCCIÓN TRIFÁSICO VITROCERÁMICA SOBRE MUEBLE ABIERTO - 4 ZONAS - VIDRO CM. 75 X 77 (INCLUIDA 1 CHAPA DE CIERRE PARA TOP MOD.TPA-9)**
cm. 80x 90x 90h



⚡ 13,6 kW _____ **5.024,00**
400V~3N _____ 74 / 0,89
230V~3
50/60 Hz

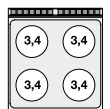

PIANI COTTURA A INDUZIONE

MOD. _____
COD. _____

DESCRIZIONE/DESCRIPTION/BEZEICHNUNG/DESCRIPTION/DESCRIPCIÓN
DIMENSIONI/DIMENSIONS/ABMESSUNGEN/DIMENSIONS/DIMENSIONES

POTENZA/POWER/LEISTUNG/PUISSANCE/POTENCIA
VOLTAGGIO/VOLTAGE/SPANNUNG/VOLTAGE/VOLTAJE

⚡ kW kcal/h
⚡ kw V~ Hz

PREZZO/PRICE €
PREIS/PRIX/PRECIO €
KG / M³

PCI-94ET
09030433

PIANO COTTURA INDUZIONE TRIFASE - N. 2 zone - Vetro cm.35x77 (inclusa 1 testata chiusura piano mod.TPA-9)
EN Three-phase induction cooking - 2 zones - glass cm.35x77 (included 1 Head end filler strip mod.TPA-9) • **DE** Induktions-Kochplatte dreiphasig - 2 zonen - Glas 35x77 cm (inbegriffen 1 Abschluss-Element mod.TPA-9) • **FR** Plan de cuisson à induction triphasé N. 2 zones - Verre cm.35x77 (inclus 1 Élément de jonction top mod.TPA-9) • **ES ENCIMERA INDUCCIÓN TRIFÁSICA - 2 ZONAS - VIDRIO CM.35X77 (INCLUIDA 1 CHAPA DE CIERRE PARA TOP MOD.TPA-9)**
cm. 40x 90x 90h



⚡ 10 kW 8.981,00
400V~3 57 / 0,46
50/60 Hz

PCIW-94ET
09030434

PIANO COTTURA INDUZIONE TRIFASE "WOK" - N. 1 zona - Vetro Ø 30 cm. (inclusa 1 testata chiusura piano mod.TPA-9)
EN Three-phase induction cooking "WOK" - 1 zone - glass Ø 30 cm (included 1 Head end filler strip mod.TPA-9) • **DE** Induktions-Kochplatte "WOK" dreiphasig - 1 zonen - Glas Ø 30 cm (inbegriffen 1 Abschluss-Element mod.TPA-9) • **FR** Plan de cuisson à induction "WOK" triphasé N. 1 zone - Verre cm Ø 30 (inclus 1 Élément de jonction top mod.TPA-9) • **ES ENCIMERA INDUCCIÓN "WOK" TRIFÁSICA - 1 ZONA - VIDRIO Ø 30 CM (INCLUIDA 1 CHAPA DE CIERRE PARA TOP MOD.TPA-9)**
cm. 40x 90x 90h



⚡ 5 kW 6.741,00
400V~3 53 / 0,46
50/60 Hz

PCI-98ET
09030833

PIANO COTTURA INDUZIONE TRIFASE - N. 4 zone - Vetro cm.75x77 (inclusa 1 testata chiusura piano mod.TPA-9)
EN Three-phase induction cooking - 4 zones - glass cm.75x77 (included 1 Head end filler strip mod.TPA-9) • **DE** Induktions-Kochplatte dreiphasig - 4 zonen - Glas 75x77 cm (inbegriffen 1 Abschluss-Element mod.TPA-9) • **FR** Plan de cuisson à induction triphasé N. 4 zones - Verre cm.75x77 (inclus 1 Élément de jonction top mod.TPA-9) • **ES ENCIMERA INDUCCIÓN TRIFÁSICA - 4 ZONAS - VIDRIO CM.75X77 (INCLUIDA 1 CHAPA DE CIERRE PARA TOP MOD.TPA-9)**
cm. 80x 90x 90h



⚡ 20,0 kW 17.137,00
400V~3 94 / 0,89
50/60 Hz

PIANI COTTURA A GAS

MOD. _____
COD. _____

DESCRIZIONE/DESCRIPTION/BEZEICHNUNG/DESCRIPTION/DESCRIPCIÓN
DIMENSIONI/DIMENSIONS/ABMESSUNGEN/DIMENSIONS/DIMENSIONES

POTENZA/POWER/LEISTUNG/PUISSANCE/POTENCIA ⚡ kW ⚡ kw
VOLTAGGIO/VOLTAGE/SPANNUNG/VOLTAGE/VOLTAJE kcal/h V- Hz PREZZO/PRICE €
PREIS/PRIX/PRECIO KG / M³

PC-94G
09210450

PIANO COTTURA GAS SU MOBILE A GIORNO 2 fuochi (inclusa 1 testata chiusura piano mod.TPC-9)
EN Gas heated boiling unit on open cabinet - 2 burners (included 1 Head end filler strip mod.TPC-9) • **DE** Gas-kochplatte mit offenem Unterbau - 2 Kochstellen (inbegriffen 1 Abschluss-Element mod.TPC-9) • **FR** Rechaud gaz sur armoire ouvert - 2 feux vifs (inclus 1 Élément de jonction top mod.TPC-9) • **ES SOBRES DE COCCIÓN GAS SOBRE MUEBLE ABIERTO - 2 QUEMADORES (INCLUIDA 1 CHAPA DE CIERRE PARA TOP MOD.TPC-9)**
cm. 40x 90x 90h



⚡ 11 kW
9.460 kcal/h

2.214,00
71 / 0,46



PC-98G
09210850

PIANO COTTURA GAS SU MOBILE A GIORNO 4 fuochi (inclusa 1 testata chiusura piano mod.TPC-9)
EN Gas heated boiling unit on open cabinet - 4 burners (included 1 Head end filler strip mod.TPC-9) • **DE** Gas-Kochplatte mit offenem Unterbau - 4 Kochstellen (inbegriffen 1 Abschluss-Element mod.TPC-9) • **FR** Rechaud gaz sur armoire ouvert - 4 feux vifs (inclus 1 Élément de jonction top mod.TPC-9) • **ES SOBRES DE COCCIÓN GAS SOBRE MUEBLE ABIERTO - 4 QUEMADORES (INCLUIDA 1 CHAPA DE CIERRE PARA TOP MOD.TPC-9)**
cm. 80x 90x 90h



⚡ 28 kW
24.080 kcal/h

3.532,00
100 / 0,89



PC-912G
09211250

PIANO COTTURA GAS SU MOBILE A GIORNO 6 fuochi (inclusa 1 testata chiusura piano mod.TPC-9)
EN Gas heated boiling unit on open cabinet - 6 burners (included 1 Head end filler strip mod.TPC-9) • **DE** Gas-Kochplatte mit offenem Unterbau - 6 Kochstellen (inbegriffen 1 Abschluss-Element mod.TPC-9) • **FR** Rechaud gaz sur armoire ouvert - 6 feux vifs (inclus 1 Élément de jonction top mod.TPC-9) • **ES SOBRES DE COCCIÓN GAS SOBRE MUEBLE ABIERTO - 6 QUEMADORES (INCLUIDA 1 CHAPA DE CIERRE PARA TOP MOD.TPC-9)**
cm. 120x 90x 90h



⚡ 45 kW
38.700 kcal/h

5.104,00
142 / 1,32

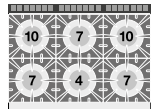

PC-916G
09211650

PIANO COTTURA GAS SU MOBILE A GIORNO 8 Fuochi (inclusa 1 testata chiusura piano mod.TPC-9)
EN Gas heated boiling unit on open cabinet - 8 burners (included 1 Head end filler strip mod.TPC-9) • **DE** Gas-Kochplatte mit offenem Unterbau - 8 Kochstellen (inbegriffen 1 Abschluss-Element mod.TPC-9) • **FR** Rechaud gaz sur armoire ouvert - 8 feux vifs (inclus 1 Élément de jonction top mod.TPC-9) • **ES SOBRES DE COCCIÓN GAS SOBRE MUEBLE ABIERTO 8 QUEMADORES (INCLUIDA 1 CHAPA DE CIERRE PARA TOP MOD.TPC-9)**
cm. 160x 90x 90h



⚡ 56 kW
48.160 kcal/h

6.702,00
182 / 1,76

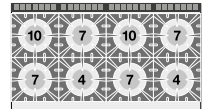

PCA-94G
09310450

PIANO COTTURA ACQUA SU MOBILE A GIORNO 2 fuochi - Rubinetto carico acqua, sfioratore (inclusa 1 testata chiusura piano mod.TPA-9)
EN water heated boiling unit on open cabinet - 2 burners - Water loading tap + overflow device (included 1 Head end filler strip mod.TPA-9) • **DE** wasser-Kochplatte mit offenem Unterbau - 2 Kochstellen - Wasserlauf-Hahn + Überlauf-Vorrichtung (inbegriffen 1 Abschluss-Element mod.TPA-9) • **FR** Rechaud l'eau sur armoire ouvert - 2 feux vifs - Robinet d'arrivée d'eau trop plein (inclus 1 Élément de jonction top mod.TPA-9) • **ES SOBRES DE COCCIÓN AGUA SOBRE MUEBLE ABIERTO 2 QUEMADORES - GRIFO CARGA AGUA + VERTEDERO (INCLUIDA 1 CHAPA DE CIERRE PARA TOP MOD.TPA-9)**
cm. 40x 90x 90h



⚡ 14 kW
12.040 kcal/h

2.770,00
71 / 0,46

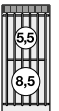

PCA-98G
09310850

PIANO COTTURA ACQUA SU MOBILE A GIORNO 4 fuochi - Rubinetto carico acqua, sfioratore (inclusa 1 testata chiusura piano mod.TPA-9)
EN water heated boiling unit on open cabinet - 4 burners - Water loading tap + overflow device (included 1 Head end filler strip mod.TPA-9) • **DE** wasser-kochplatte mit offenem Unterbau - 4 Kochstellen - Wasserlauf-Hahn + Überlauf-Vorrichtung (inbegriffen 1 Abschluss-Element mod.TPA-9) • **FR** Rechaud l'eau sur armoire ouvert - 4 feux vifs - Robinet d'arrivée d'eau trop plein (inclus 1 Élément de jonction top mod.TPA-9) • **ES SOBRES DE COCCIÓN AGUA SOBRE MUEBLE ABIERTO 4 QUEMADORES - GRIFO CARGA AGUA + VERTEDERO (INCLUIDA 1 CHAPA DE CIERRE PARA TOP MOD.TPA-9)**
cm. 80x 90x 90h



⚡ 28 kW
24.080 kcal/h

4.442,00
100 / 0,89

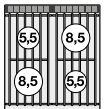

PIANI COTTURA AD ACQUA A GAS

MOD. _____ DESCRIZIONE/DESCRIPTION/BEZEICHNUNG/DESCRIPTION/DESCRIPCIÓN POTENZA/POWER/LEISTUNG/PUISSANCE/POTENCIA $\frac{kW}{kcal/h}$ $\frac{kW}{V-}$ $\frac{Hz}{Hz}$ PREZZO/PRICE € PREIS/PRIX/PRECIO KG / M³
 COD. _____ DIMENSIONI/DIMENSIONS/ABMESSUNGEN/DIMENSIONS/DIMENSIONES VOLTAGGIO/VOLTAGE/SPANNUNG/VOLTAGE/VOLTAJE

PCA-912G
09311250

PIANO COTTURA ACQUA SU MOBILE A GIORNO 6 fuochi - Rubinetto carico acqua, sfioratore (inclusa 1 testata chiusura piano mod.TPA-9)
EN water heated boiling unit on open cabinet - 6 burners - Water loading tap + overflow device (included 1 Head end filler strip mod.TPA-9) • **DE** wasser-kochplatte mit offenem Unterbau - 6 Kochstellen - Wasserlauf-Hahn + Überlauf-Vorrichtung (inbegriffen 1 Abschluss-Element mod. TPA-9) • **FR** Rechaud l'eau sur armoire ouvert - 6 feux vifs - Robinet d'arrivée d'eau trop plein (inclus 1 Élément de jonction top mod.TPA-9) • **ES SOBRES DE COCCIÓN AGUA SOBRE MUEBLE ABIERTO 6 QUEMADORES - GRIFO CARGA AGUA + VERTEDERO (INCLUIDA 1 CHAPA DE CIERRE PARA TOP MOD.TPA-9)**
cm. 120x 90x 90h

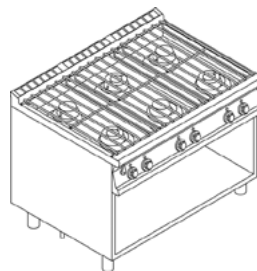

42 kW
36.120 kcal/h

6.413,00
142 / 1,32

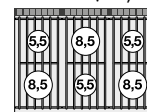

PA-98G
09210851

"PAELLERO" GAS SU MOBILE A GIORNO (inclusa 1 testata chiusura piano mod.TPC-9)
EN "PAELLERO" Gas - open cabinet (included 1 Head end filler strip mod.TPC-9) • **DE** "PAELLERO" Gas mit offenem Unterbau (inbegriffen 1 Abschluss-Element mod.TPC-9) • **FR** "PAELLERO" gaz sur armoire ouvert (inclus 1 Élément de jonction top mod.TPC-9) • **ES "PAELLERO" GAS SOBRE MUEBLE ABIERTO (INCLUIDA 1 CHAPA DE CIERRE PARA TOP MOD.TPC-9)**
cm. 80x 90x 90h



26,7 kW
22.962 kcal/h

5.066,00
134 / 0,89

PAF-98G
09680851

"PAELLERO" GAS SU FORNO GAS statico cm. 67x73x34h, temp: 150÷300°C, con 1 griglia cm.65x71 GN2/1 (inclusa 1 testata chiusura piano mod.TPC-9)
EN "PAELLERO" Gas on Traditional gas-oven cm. 67x73x34h, temp: 150÷300°C, with 1 grid cm.65x71 GN2/1 (included 1 Head end filler strip mod.TPC-9) • **DE** "PAELLERO" Gas mit Statischer Gas-Backofen cm. 67x73x34h, temp: 150÷300°C, mit 1 Rost cm.65x71 GN2/1 (inbegriffen 1 Abschluss-Element mod.TPC-9) • **FR** "PAELLERO" gaz sur Four à gaz statique cm. 67x73x34h, temp: 150÷300°C, avec 1 grille cm.65x71 GN2/1 (inclus 1 Élément de jonction top mod.TPC-9) • **ES "PAELLERO" GAS SOBRE HORNO A GAS ESTÁTICO CM. 67X73X34H, TEMP: 150÷300 °C, CON 1 PARILLA CM.65X71 GN2/1 (INCLUIDA 1 CHAPA DE CIERRE PARA TOP MOD. TPC-9)**
cm. 80x 90x 90h



35,2 kW
30.272 kcal/h

6.686,00
184 / 0,89

TP-94G
09290450

TUTTA PIASTRA GAS SU MOBILE A GIORNO Piastra cm 39x73 (inclusa 1 testata chiusura piano mod.TPC-9)
EN Solid top on open unit - plate 39x73 cm (included 1 Head end filler strip mod.TPC-9) • **DE** Kochplatte auf offenem Unterbau - Platte 39x73 cm (inbegriffen 1 Abschluss-Element mod.TPC-9) • **FR** Toute plaque sur meuble ouvert - Plaque cm 39x73 (inclus 1 Élément de jonction top mod. TPC-9) • **ES PLACA DE COCCIÓN SOBRE MUEBLE ABIERTO - PLACA CM 39X73 (INCLUIDA 1 CHAPA DE CIERRE PARA TOP MOD.TPC-9)**
cm. 40x 90x 90h

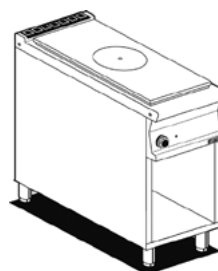

7 kW
6.020 kcal/h

2.658,00
75 / 0,46

TP-98G
09290850

TUTTA PIASTRA GAS SU MOBILE A GIORNO Piastra cm 79x73 (inclusa 1 testata chiusura piano mod.TPC-9)
EN Solid top on open unit - Plate 79x73 cm (included 1 Head end filler strip mod.TPC-9) • **DE** Kochplatte auf offenem Unterbau - Platte 79x73 cm (inbegriffen 1 Abschluss-Element mod.TPC-9) • **FR** Toute plaque sur meuble ouvert - Plaque cm 79x73 (inclus 1 Élément de jonction top mod. TPC-9) • **ES PLACA DE COCCIÓN SOBRE MUEBLE ABIERTO - PLACA CM 79X73 (INCLUIDA 1 CHAPA DE CIERRE PARA TOP MOD.TPC-9)**
cm. 80x 90x 90h



12 kW
10.320 kcal/h

3.900,00
144 / 0,89

TUTTAPIASTRA A GAS

MOD. _____
COD. _____

DESCRIZIONE/DESCRIPTION/BEZEICHNUNG/DESCRIPTION/DESCRIPCIÓN
DIMENSIONI/DIMENSIONS/ABMESSUNGEN/DIMENSIONS/DIMENSIONES

POTENZA/POWER/LEISTUNG/PUISSANCE/POTENCIA
VOLTAGGIO/VOLTAGE/SPANNUNG/VOLTAGE/VOLTAGE

⚡ kW _____
kcal/h _____
⚡ kW _____
V- _____
Hz _____

PREZZO/PRICE € _____
PREIS/PRIX/PRECIO € _____
KG / M³ _____

TP2-98G
09300850

TUTTA PIASTRA + 2 FUOCHI SU MOBILE A GIORNO Piastra cm. 39x73 (inclusa 1 testata chiusura piano mod.TPC-9)
EN Solid top + 2 burners on open unit Plate 39x73 (included 1 Head end filler strip mod.TPC-9) • **DE** Kochplatte + 2 Gaskochstellen auf offenem Unterbau Platte 39x73 (inbegriffen 1 Abschluss-Element mod. TPC-9) • **FR** Toute plaque + 2 brûleurs sur meuble ouvert Plaque cm. 39x73 (inclus 1 Élément de jonction top mod.TPC-9) • **ES PLACA DE COCCIÓN + 2 FUEGOS SOBRE MUEBLE ABIERTO PLACA CM. 39X73 (INCLUIDA 1 CHAPA DE CIERRE PARA TOP MOD. TPC-9)**
cm. 80x 90x 90h

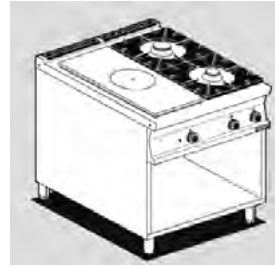

⚡ 24 kW _____
20.640 kcal/h _____ **3.886,00**
139 / 0,89

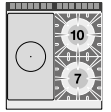

TP2-912G
09291250

TUTTA PIASTRA + 2 FUOCHI SU MOBILE A GIORNO Piastra cm. 79x73 (inclusa 1 testata chiusura piano mod.TPC-9)
EN Solid top + 2 burners on open unit Plate 79x73 (included 1 Head end filler strip mod.TPC-9) • **DE** Kochplatte + 2 Gaskochstellen auf offenem Unterbau Platte 79x73 (inbegriffen 1 Abschluss-Element mod. TPC-9) • **FR** Toute plaque + 2 brûleurs sur meuble ouvert Plaque cm. 79x73 (inclus 1 Élément de jonction top mod.TPC-9) • **ES PLACA DE COCCIÓN + 2 FUEGOS SOBRE MUEBLE ABIERTO PLACA CM. 79X73 (INCLUIDA 1 CHAPA DE CIERRE PARA TOP MOD. TPC-9)**
cm. 120x 90x 90h



⚡ 29 kW _____
24.940 kcal/h _____ **5.635,00**
166 / 1,32

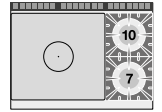

TP4-912G
09301250

TUTTA PIASTRA + 4 FUOCHI SU MOBILE A GIORNO Piastra cm. 39x73 (inclusa 1 testata chiusura piano mod.TPC-9)
EN Solid top + 4 burners on open unit Plate 39x73 cm (included 1 Head end filler strip mod.TPC-9) • **DE** Kochplatte + 4 Gaskochstellen auf offenem Unterbau Platte 39x73 cm (inbegriffen 1 Abschluss-Element mod. TPC-9) • **FR** Toute plaque + 4 brûleurs sur meuble ouvert Plaque cm. 39x73 (inclus 1 Élément de jonction top mod.TPC-9) • **ES PLACA DE COCCIÓN + 4 FUEGOS SOBRE MUEBLE ABIERTO PLACA CM. 39X73 (INCLUIDA 1 CHAPA DE CIERRE PARA TOP MOD. TPC-9)**
cm. 120x 90x 90h



⚡ 35 kW _____
30.100 kcal/h _____ **5.398,00**
160 / 1,32

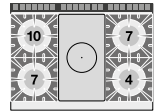

TP-98ET
09120830

TUTTA PIASTRA SU MOBILE A GIORNO Piastra cm. 70x68 - 4 zone (inclusa 1 testata chiusura piano mod.TPA-9)
EN Solid top on open unit - Plate cm. 70x68 (included 1 Head end filler strip mod.TPA-9) • **DE** Kochplatten auf offenem Unterbau - Platte cm. 70x68 (inbegriffen 1 Abschluss-Element mod.TPA-9) • **FR** Toute plaque sur meuble ouvert - Plaque cm. 70x68 (inclus 1 Élément de jonction top mod.TPA-9) • **ES PLACA DE COCCIÓN SOBRE MUEBLE ABIERTO - PLACA CM. 70X68 (INCLUIDA 1 CHAPA DE CIERRE PARA TOP MOD.TPA-9)**
cm. 80x 90x 90h



⚡ 13,6 kW _____ **4.758,00**
400V~3N _____ 114 / 0,89
50/60 Hz

TPI-98ET
09120833

TUTTOPIANO INDUZIONE TRIFASE - Vetro cm.75x77 (inclusa 1 testata chiusura piano mod.TPA-9)
EN Three-phase induction Solid top - glass cm.75x77 (included 1 Head end filler strip mod.TPA-9) • **DE** Induktions-Kochplatte dreiphasig - Glas 75x77 cm (inbegriffen 1 Abschluss-Element mod.TPA-9) • **FR** Toute plaque à induction triphasé - Verre cm.75x77 (inclus 1 Élément de jonction top mod.TPA-9) • **ES PLACA DE COCCIÓN INDUCCIÓN TRIFÁSICA - VIDRIO CM.75X77 (INCLUIDA 1 CHAPA DE CIERRE PARA TOP MOD.TPA-9)**
cm. 80x 90x 90h



⚡ 28 kW _____ **25.680,00**
400V~3 _____ 95 / 0,89
50/60 Hz

TUTTAPIASTRA ELETTRICO CON FORNO

MOD. / COD. DESCRIZIONE / DESCRIPTION / BEZEICHNUNG / DESCRIPTION / DESCRIPCIÓN DIMENSIONI / DIMENSIONS / ABMESSUNGEN / DIMENSIONS / DIMENSIONES POTENZA / POWER / LEISTUNG / PUISSANCE / POTENCIA VOLTAGGIO / VOLTAGE / SPANNUNG / VOLTAGE / VOLTAJE $\frac{\text{kW}}{\text{kcal/h}}$ $\frac{\text{V}}{\text{Hz}}$ PREZZO / PRICE € PREIS / PRIX / PRECIO € KG / M³

TPF-98ET
09670830

Tutta piastra su Forno elettrico statico cm. 67x73x34h, temp: 50÷300°C, con 1 griglia cm.65x71 GN2/1 - piastra cm. 70x68 4 zone (inclusa 1 testata chiusura piano mod.TPA-9)

EN Solid top on traditional electric cm. 67x73x34h, temp: 50÷300°C, with 1 grid cm.65x71 GN2/1 - Plate cm. 70x68 4 zones (included 1 Head end filler strip mod.TPA-9) • **DE** Kochplatten - Statischer Elektro-Backofen cm. 67x73x34h, temp: 50÷300°C, mit 1 Rost cm.65x71 GN2/1 - Platte cm. 70x68 4 zonen (inbegriffen 1 Abschluss-Element mod. TPA-9) • **FR** Toute plaque sur Four électrique statique cm. 67x73x34h, temp: 50÷300°C, avec 1 grille cm.65x71 GN2/1 - Plaque cm. 70x68 4 zones (inclus 1 Élément de jonction top mod.TPA-9) • **ES PLACA DE COCCIÓN SOBRE HORNO ELÉCTRICO ESTÁTICO CM. 67X73X34H, TEMP: 50÷300 °C, CON 1 PARILLA CM.65X71 GN2/1 - PLACA CM. 70X68 4 ZONAS (INCLUIDA 1 CHAPA DE CIERRE PARA TOP MOD.TPA-9)**

cm. 80x 90x 90h



$\frac{20,3 \text{ kW}}{400\text{V}\sim 3\text{N}}$ $\frac{6.206,00}{180 / 0,89}$
50/60 Hz

TPFV-98ET
09670835

Tutta piastra su Forno elettrico ventilato cm. 55x36x34h, temp: 50÷300°C, con 1 griglia cm.53x32,5 GN1/1 - piastra cm. 70x68 4 zone (inclusa 1 testata chiusura piano mod.TPA-9)

EN Solid top on electric fan oven cm. 55x36x34h, temp: 50÷300°C, with 1 grid cm.53x32,5 GN1/1 - Plate cm. 70x68 4 zones (included 1 Head end filler strip mod.TPA-9) • **DE** Kochplatten - Elektro-Heißluftofen cm. 55x36x34h, temp: 50÷300°C, mit 1 Rost cm.53x32,5 GN1/1 - Platte cm. 70x68 4 Zonen (inbegriffen 1 Abschluss-Element mod.TPA-9) • **FR** Toute plaque sur Four à chaleur tournante électrique cm. 55x36x34h, temp: 50÷300°C, avec 1 grille cm.53x32,5 GN1/1 - Plaque cm. 70x68 4 zones (inclus 1 Élément de jonction top mod. TPA-9) • **ES PLACA DE COCCIÓN SOBRE HORNO ELÉCTRICO VENTILADO CM. 55X36X34H, TEMP: 50÷300 °C, CON 1 PARILLA CM.53X32,5 GN1/1 - PLACA CM. 70X68 4 ZONAS (INCLUIDA 1 CHAPA DE CIERRE PARA TOP MOD.TPA-9)**

cm. 80x 90x 90h

$\frac{18,92 \text{ kW}}{400\text{V}\sim 3\text{N}}$ $\frac{6.692,00}{180 / 0,89}$
50/60 Hz

TPF-98G
09700850

TUTTA PIASTRA SU FORNO GAS statico cm. 67x73x34h, temp: 150÷300°C, con 1 griglia cm.65x71 GN2/1 - Piastra cm 79x73 (inclusa 1 testata chiusura piano mod.TPC-9)

EN Solid top on Traditional gas-oven cm. 67x73x34h, temp: 150÷300°C, with 1 grid cm.65x71 GN2/1 - Plate cm. 79x73 (included 1 Head end filler strip mod.TPC-9) • **DE** Kochplatten - Statischer Gas-Backofen cm. 67x73x34h, temp: 150÷300°C, mit 1 Rost cm.65x71 GN2/1 - Platte cm. 79x73 (inbegriffen 1 Abschluss-Element mod.TPC-9) • **FR** Toute plaque sur Four à gaz statique cm. 67x73x34h, temp: 150÷300°C, avec 1 grille cm.65x71 GN2/1 - Plaque cm. 79x73 (inclus 1 Élément de jonction top mod.TPC-9) • **ES PLACA DE COCCIÓN SOBRE HORNO A GAS ESTÁTICO CM. 67X73X34H, TEMP: 150÷300 °C, CON 1 PARILLA CM.65X71 GN2/1 - PLACA CM. 79X73 (INCLUIDA 1 CHAPA DE CIERRE PARA TOP MOD.TPC-9)**

cm. 80x 90x 90h



$\frac{20,5 \text{ kW}}{17.630 \text{ kcal/h}}$ $\frac{5.693,00}{194 / 0,89}$

TPF-98GE
09710860

Tutta piastra su Forno elettrico statico cm. 67x73x34h, temp: 50÷300°C, con 1 griglia cm.65x71 GN2/1 - piastra cm. 79x73 (inclusa 1 testata chiusura piano mod.TPC-9)

EN Solid top on traditional electric oven cm. 67x73x34h, temp: 50÷300°C, with 1 grid cm.65x71 GN2/1 - Plate cm. 79x73 (included 1 Head end filler strip mod.TPC-9) • **DE** Kochplatten - Statischer Elektro-Backofen cm. 67x73x34h, temp: 50÷300°C, mit 1 Rost cm.65x71 GN2/1 - Platte cm. 79x73 (inbegriffen 1 Abschluss-Element mod.TPC-9) • **FR** Toute plaque sur Four électrique statique cm. 67x73x34h, temp: 50÷300°C, avec 1 grille cm.65x71 GN2/1 - Plaque cm. 79x73 (inclus 1 Élément de jonction top mod.TPC-9) • **ES PLACA DE COCCIÓN SOBRE HORNO ELÉCTRICO ESTÁTICO CM. 67X73X34H, TEMP: 50÷300 °C, CON 1 PARILLA CM.65X71 GN2/1 - PLACA CM. 79X73 (INCLUIDA 1 CHAPA DE CIERRE PARA TOP MOD.TPC-9)**

cm. 80x 90x 90h



$\frac{12 \text{ kW}}{10.320 \text{ kcal/h}}$ $\frac{5.810,00}{196 / 0,89}$
 $\frac{6,7 \text{ kW}}{400\text{V}\sim 3\text{N}}$
50/60 Hz

TUTTAPIASTRA A GAS CON FORNO ELETTRICO

MOD. _____
COD. _____

DESCRIZIONE/DESCRIPTION/BEZEICHNUNG/DESCRIPTION/DESCRIPCIÓN
DIMENSIONI/DIMENSIONS/ABMESSUNGEN/DIMENSIONS/DIMENSIONES

POTENZA/POWER/LEISTUNG/PUISSANCE/POTENCIA
VOLTAGGIO/VOLTAGE/SPANNUNG/VOLTAGE/VOLTAJE

⚡ kW kcal/h
⚡ kW V- Hz

PREZZO/PRICE €
PREIS/PRIX/PRECIO €
KG / M³

TPFV-98GE
09710865

Tutta piastra su Forno elettrico ventilato cm. 55x36x34h, temp: 50÷300°C, con 1 griglia cm.53x32,5 GN1/1 - piastra cm. 79x73 (inclusa 1 testata chiusura piano mod.TPC-9)

EN Solid top on electric fan oven cm. 55x36x34h, temp: 50÷300°C, with 1 grid cm.53x32,5 GN1/1 - Plate cm. 79x73 (included 1 Head end filler strip mod.TPC-9) • **DE** Kochplatten - Elektro-Heißluftofen cm. 55x36x34h, temp: 50÷300°C, mit 1 Rost cm.53x32,5 GN1/1 - Platte cm. 79x73 (inbegriffen 1 Abschluss-Element mod.TPC-9) • **FR** Toute plaque sur Four à chaleur tournante électrique cm. 55x36x34h, temp: 50÷300°C, avec 1 grille cm.53x32,5 GN1/1 - Plaque cm. 79x73 (inclus 1 Élément de jonction top mod.TPC-9) • **ES PLACA DE COCCIÓN SOBRE HORNO ELÉCTRICO VENTILADO CM. 55X36X34H, TEMP: 50÷300°C, CON 1 PARILLA CM.53X32,5 GN1/1 - PLACA CM. 79X73 (INCLUIDA 1 CHAPA DE CIERRE PARA TOP MOD.TPC-9)**

cm. 80x 90x 90h



⚡ 12 kW 6.286,00
10.320 kcal/h 196 / 0,89

⚡ 5,32 kW
400V~3N
230V~3
50/60 Hz

TPF2-98G
09720850

TUTTA PIASTRA + 2 FUOCHI SU FORNO GAS statico cm. 67x73x34h, temp: 150÷300°C, con 1 griglia cm.65x71 GN2/1 - Piastra cm 39x73 (inclusa 1 testata chiusura piano mod.TPC-9)

EN Solid top + 2 burners Traditional gas-oven cm. 67x73x34h, temp: 150÷300°C, with 1 grid cm.65x71 GN2/1 - Plate 39x73 (included 1 Head end filler strip mod.TPC-9) • **DE** Kochplatte + 2 Gaskochstellen auf Statischer Gas-Backofen cm. 67x73x34h, temp: 150÷300°C, mit 1 Rost cm.65x71 GN2/1 - Platte 39x73 cm (inbegriffen 1 Abschluss-Element mod.TPC-9) • **FR** Toute plaque + 2 brûleurs sur Four à gaz statique cm. 67x73x34h, temp: 150÷300°C, avec 1 grille cm.65x71 GN2/1 - Plaque cm. 39x73 (inclus 1 Élément de jonction top mod.TPC-9) • **ES PLACA DE COCCIÓN + 2 FUEGOS SOBRE HORNO A GAS ESTÁTICO CM. 67X73X34H, TEMP: 150÷300°C, CON 1 PARILLA CM.65X71 GN2/1 - PLACA CM 39X73 (INCLUIDA 1 CHAPA DE CIERRE PARA TOP MOD.TPC-9)**

cm. 80x 90x 90h



⚡ 32,5 kW 5.732,00
27.950 kcal/h 181 / 0,89

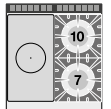

TPF2-98GE
09730860

TUTTA PIASTRA + 2 FUOCHI SU Forno elettrico statico cm. 67x73x34h, temp: 50÷300°C, con 1 griglia cm.65x71 GN2/1 - Piastra cm 39x73 (inclusa 1 testata chiusura piano mod.TPC-9)

EN Solid top + 2 burners traditional electric oven cm. 67x73x34h, temp: 50÷300°C, with 1 grid cm.65x71 GN2/1 - Plate 39x73 (included 1 Head end filler strip mod.TPC-9) • **DE** Kochplatte + 2 Gaskochstellen auf Statischer Elektro-Backofen cm. 67x73x34h, temp: 50÷300°C, mit 1 Rost cm.65x71 GN2/1 - Platte 39x73 (inbegriffen 1 Abschluss-Element mod.TPC-9) • **FR** Toute plaque + 2 brûleurs sur Four électrique statique cm. 67x73x34h, temp: 50÷300°C, avec 1 grille cm.65x71 GN2/1 - Plaque cm. 39x73 (inclus 1 Élément de jonction top mod.TPC-9) • **ES PLACA DE COCCIÓN + 2 FUEGOS SOBRE HORNO ELÉCTRICO ESTÁTICO GN 2/1 CM. 68X73X34H, TEMP: 50÷300°C, PLACA CM 39X73 (INCLUIDA 1 CHAPA DE CIERRE PARA TOP MOD.TPC-9)**

cm. 80x 90x 90h



⚡ 24 kW 5.848,00
20.640 kcal/h 191 / 0,89

⚡ 6,7 kW
400V~3N
50/60 Hz

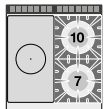

TPFV2-98GE
09730865

TUTTA PIASTRA + 2 FUOCHI SU Forno elettrico ventilato cm. 55x36x34h, temp: 50÷300°C, con 1 griglia cm.53x32,5 GN1/1 - Piastra cm 39x73 (inclusa 1 testata chiusura piano mod.TPC-9)

EN Solid top + 2 burners electric fan oven cm. 55x36x34h, temp: 50÷300°C, with 1 grid cm.53x32,5 GN1/1 - Plate 39x73 (included 1 Head end filler strip mod.TPC-9) • **DE** Kochplatte + 2 Gaskochstellen - Elektro-Heißluftofen cm. 55x36x34h, temp: 50÷300°C, mit 1 Rost cm.53x32,5 GN1/1 - Platte 39x73 (inbegriffen 1 Abschluss-Element mod.TPC-9) • **FR** Toute plaque + 2 brûleurs sur Four à chaleur tournante électrique cm. 55x36x34h, temp: 50÷300°C, avec 1 grille cm.53x32,5 GN1/1 - Plaque cm. 39x73 (inclus 1 Élément de jonction top mod.TPC-9) • **ES PLACA DE COCCIÓN + 2 FUEGOS SOBRE HORNO ELÉCTRICO VENTILADO CM. 55X36X34H, TEMP: 50÷300°C, CON 1 PARILLA CM.53X32,5 GN1/1 - PLACA CM 39X73 (INCLUIDA 1 CHAPA DE CIERRE PARA TOP MOD.TPC-9)**

cm. 80x 90x 90h

⚡ 24 kW 6.321,00
20.640 kcal/h 191 / 0,89

⚡ 5,32 kW
400V~3N
230V~3
50/60 Hz

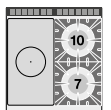

TUTTAPIASTRA A GAS CON FORNO

MOD. _____
COD. _____

DESCRIZIONE/DESCRIPTION/BEZEICHNUNG/DESCRIPTION/DESCRIPCIÓN
DIMENSIONI/DIMENSIONS/ABMESSUNGEN/DIMENSIONS/DIMENSIONES

POTENZA/POWER/LEISTUNG/PUISSANCE/POTENCIA
VOLTAGGIO/VOLTAGE/SPANNUNG/VOLTAGE/VOLTAJE

⚡ kW
kcal/h

⚡ kW
V~
Hz

PREZZO/PRICE €
PREIS/PRIX/PRECIO €
KG / M³

TPF2-912GV TUTTA PIASTRA + 2 FUOCHI SU FORNO GAS statico cm. 67x73x34h, temp: 150÷300°C, con 1 griglia cm.65x71 GN2/1 - Piastra cm 79x73 - vano neutro con porta (inclusa 1 testata chiusura piano mod.TPC-9)
EN Solid top + 2 burners Traditional gas-oven cm. 67x73x34h, temp: 150÷300°C, with 1 grid cm.65x71 GN2/1 - Plate 79x73 cm - Neutral cabinet with door (included 1 Head end filler strip mod.TPC-9) • **DE** Kochplatte + 2 Gaskochstellen auf Statischer Gas-Backofen cm. 67x73x34h, temp: 150÷300°C, mit 1 Rost cm.65x71 GN2/1 - Platte 79x73 cm - Neutrales Schrankelement mit Tür (inbegriffen 1 Abschluss-Element mod.TPC-9) • **FR** Toute plaque + 2 brûleurs sur Four à gaz statique cm. 67x73x34h, temp: 150÷300°C, avec 1 grille cm.65x71 GN2/1 - Plaque cm. 79x73 - Element neutre avec porte (inclus 1 Élément de jonction top mod.TPC-9) • **ES PLACA DE COCCIÓN + 2 FUEGOS SOBRE HORNO A GAS ESTÁTICO CM. 67X73X34H, TEMP: 150÷300 °C, CON 1 PARILLA CM.65X71 GN2/1 - PLACA CM 79X73 - ARMARIO NEUTRO CON PUERTA (INCLUIDA 1 CHAPA DE CIERRE PARA TOP MOD. TPC-9)**
cm. 120x 90x 90h



⚡ 37,5 kW
32.250 kcal/h

7.662,00
254 / 1,32

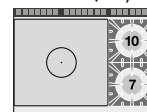

TPF2-912GEV TUTTA PIASTRA + 2 FUOCHI SU Forno elettrico statico cm. 67x73x34h, temp: 50÷300°C, con 1 griglia cm.65x71 GN2/1 - Piastra cm 79x73 - vano neutro con porta (inclusa 1 testata chiusura piano mod.TPC-9)
EN Solid top + 2 burners traditional electric oven cm. 67x73x34h, temp: 50÷300°C, with 1 grid cm.65x71 GN2/1 - Plate 79x73 cm - Neutral cabinet with door (included 1 Head end filler strip mod.TPC-9) • **DE** Kochplatte + 2 Gaskochstellen auf Statischer Elektro-Backofen cm. 67x73x34h, temp: 50÷300°C, mit 1 Rost cm.65x71 GN2/1 - Platte 79x73 cm - Neutrales Schrankelement mit Tür (inbegriffen 1 Abschluss-Element mod.TPC-9) • **FR** Toute plaque + 2 brûleurs sur Four électrique statique cm. 67x73x34h, temp: 50÷300°C, avec 1 grille cm.65x71 GN2/1 - Plaque cm. 79x73 - Element neutre avec porte (inclus 1 Élément de jonction top mod.TPC-9) • **ES PLACA DE COCCIÓN + 2 FUEGOS SOBRE HORNO ELÉCTRICO ESTÁTICO CM. 67X73X34H, TEMP: 50÷300 °C, CON 1 PARILLA CM.65X71 GN2/1 - PLACA CM 79X73 - ARMARIO NEUTRO CON PUERTA (INCLUIDA 1 CHAPA DE CIERRE PARA TOP MOD. TPC-9)**
cm. 120x 90x 90h



⚡ 29 kW
24.940 kcal/h

7.779,00
250 / 1,32

⚡ 6,7 kW
400V~3N
50/60 Hz

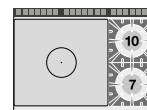

TPFV2-912GEV TUTTA PIASTRA + 2 FUOCHI SU Forno elettrico ventilato cm. 55x36x34h, temp: 50÷300°C, con 1 griglia cm.53x32,5 GN1/1 - Piastra cm 79x73 - vano neutro con porta (inclusa 1 testata chiusura piano mod.TPC-9)
EN Solid top + 2 burners electric fan oven cm. 55x36x34h, temp: 50÷300°C, with 1 grid cm.53x32,5 GN1/1 - Plate 79x73 cm - Neutral cabinet with door (included 1 Head end filler strip mod.TPC-9) • **DE** Kochplatte + 2 Gaskochstellen - Elektro-Heißluftofen cm. 55x36x34h, temp: 50÷300°C, mit 1 Rost cm.53x32,5 GN1/1 - Platte 79x73 cm - Neutrales Schrankelement mit Tür (inbegriffen 1 Abschluss-Element mod.TPC-9) • **FR** Toute plaque + 2 brûleurs sur Four à chaleur tournante électrique cm. 55x36x34h, temp: 50÷300°C, avec 1 grille cm.53x32,5 GN1/1 - Plaque cm. 79x73 - Element neutre avec porte (inclus 1 Élément de jonction top mod.TPC-9) • **ES PLACA DE COCCIÓN + 2 FUEGOS SOBRE HORNO ELÉCTRICO VENTILADO CM. 55X36X34H, TEMP: 50÷300 °C, CON 1 PARILLA CM.53X32,5 GN1/1 - PLACA CM 79X73 - ARMARIO NEUTRO CON PUERTA (INCLUIDA 1 CHAPA DE CIERRE PARA TOP MOD.TPC-9)**
cm. 120x 90x 90h

⚡ 29 kW
24.940 kcal/h

8.253,00
250 / 1,32

⚡ 5,32 kW
400V~3N
230V~3
50/60 Hz

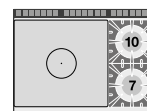

TUTTAPIASTRA A GAS CON FORNO

MOD. _____
COD. _____

DESCRIZIONE/DESCRIPTION/BEZEICHNUNG/DESCRIPTION/DESCRIPCIÓN
DIMENSIONI/DIMENSIONS/ABMESSUNGEN/DIMENSIONS/DIMENSIONES

POTENZA/POWER/LEISTUNG/PUISSANCE/POTENCIA
VOLTAGGIO/VOLTAGE/SPANNUNG/VOLTAGE/VOLTAJE

⚡ kW _____
kcal/h _____
⚡ kw _____
V~ _____
Hz _____

PREZZO/PRICE €
PREIS/PRIX/PRECIO _____
KG / M³

TPF2-912G
09701250

TUTTA PIASTRA + 2 FUOCHI SU FORNO GAS statico cm. 107x73x34h, temp: 150÷300°C, con 1 griglia cm.105x71 - Piastra cm 79x73 (inclusa 1 testata chiusura piano mod.TPC-9)
EN Solid top + 2 burners Traditional gas-oven cm. 107x73x34h, temp: 150÷300°C, with 1 grid cm.105x71 - Plate 79x73 (included 1 Head end filler strip mod.TPC-9) • **DE** Kochplatte + 2 Gaskochstellen auf Statischer Gas-Backofen cm. 107x73x34h, temp: 150÷300°C, mit 1 Rost cm.105x71 - Platte 79x73 (inbegriffen 1 Abschluss-Element mod.TPC-9) • **FR** Toute plaque + 2 brûleurs sur Four à gaz statique cm. 107x73x34h, temp: 150÷300°C, avec 1 grille cm.105x71 - Plaque cm. 79x73 (inclus 1 Élément de jonction top mod.TPC-9) • **ES PLACA DE COCCIÓN + 2 FUEGOS SOBRE HORNO A GAS ESTÁTICO CM. 107X73X34H, TEMP: 150÷300°C, CON 1 PARILLA CM.105X71 - PLACA CM 79X73 (INCLUIDA 1 CHAPA DE CIERRE PARA TOP MOD.TPC-9) cm. 120x 90x 90h**



⚡ 42 kW **8.034,00**
36.080 kcal/h 264 / 1,32

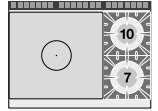

TPF2-912GE
09711260

TUTTA PIASTRA + 2 FUOCHI SU Forno elettrico statico cm. 107x73x34h, temp: 50÷300°C, con 1 griglia cm.105x71 - Piastra cm 79x73 (inclusa 1 testata chiusura piano mod.TPC-9)
EN Solid top + 2 burners traditional electric oven cm. 107x73x34h, temp: 50÷300°C, with 1 grid cm.105x71 - Plate 79x73 (included 1 Head end filler strip mod.TPC-9) • **DE** Kochplatte + 2 Gaskochstellen auf Statischer Elektro-Backofen cm. 107x73x34h, temp: 50÷300°C, mit 1 Rost cm.105x71 - Platte 79x73 (inbegriffen 1 Abschluss-Element mod.TPC-9) • **FR** Toute plaque + 2 brûleurs sur Four électrique statique cm. 107x73x34h, temp: 50÷300°C, avec 1 grille cm.105x71 - Plaque cm. 79x73 (inclus 1 Élément de jonction top mod.TPC-9) • **ES PLACA DE COCCIÓN + 2 FUEGOS SOBRE HORNO ELÉCTRICO ESTÁTICO CM. 107X73X34H, TEMP: 50÷300°C, CON 1 PARILLA CM.105X71 - PLACA CM 79X73 (INCLUIDA 1 CHAPA DE CIERRE PARA TOP MOD.TPC-9) cm. 120x 90x 90h**



⚡ 29 kW **8.187,00**
24.940 kcal/h 260 / 1,32

⚡ 9,2 kW
400V~3N
50/60 Hz

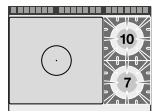

TPF4-912GV
09721251

TUTTA PIASTRA + 4 FUOCHI SU FORNO GAS statico cm. 67x73x34h, temp: 150÷300°C, con 1 griglia cm.65x71 GN2/1 - Piastra cm 39x73 - vano neutro con porta (inclusa 1 testata chiusura piano mod.TPC-9)
EN Solid top + 4 burners Traditional gas-oven cm. 67x73x34h, temp: 150÷300°C, with 1 grid cm.65x71 GN2/1 - Plate 39x73 cm - Neutral cabinet with door (included 1 Head end filler strip mod.TPC-9) • **DE** Kochplatte + 4 Gaskochstellen auf Statischer Gas-Backofen cm. 67x73x34h, temp: 150÷300°C, mit 1 Rost cm.65x71 GN2/1 - Platte 39x73 cm - Neutrales Schrankelement mit Tür (inbegriffen 1 Abschluss-Element mod.TPC-9) • **FR** Toute plaque + 4 brûleurs sur Four à gaz statique cm. 67x73x34h, temp: 150÷300°C, avec 1 grille cm.65x71 GN2/1 - Plaque cm. 39x73 - Element neutre avec porte (inclus 1 Élément de jonction top mod.TPC-9) • **ES PLACA DE COCCIÓN + 4 FUEGOS SOBRE HORNO A GAS ESTÁTICO CM. 67X73X34H, TEMP: 150÷300°C, CON 1 PARILLA CM.65X71 GN2/1 - PLACA CM 39X73 - ARMARIO NEUTRO CON PUERTA (INCLUIDA 1 CHAPA DE CIERRE PARA TOP MOD.TPC-9) cm. 120x 90x 90h**



⚡ 43,5 kW **7.768,00**
37.410 kcal/h 249 / 1,32

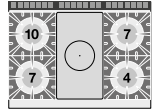

TPF4-912GEV
09731261

TUTTA PIASTRA + 4 FUOCHI SU Forno elettrico statico cm. 67x73x34h, temp: 50÷300°C, con 1 griglia cm.65x71 GN2/1 - Piastra cm 39x73 - vano neutro con porta (inclusa 1 testata chiusura piano mod.TPC-9)
EN Solid top + 4 burners traditional electric oven cm. 67x73x34h, temp: 50÷300°C, with 1 grid cm.65x71 GN2/1 - Plate 39x73 cm - Neutral cabinet with door (included 1 Head end filler strip mod.TPC-9) • **DE** Kochplatte + 4 Gaskochstellen auf Statischer Elektro-Backofen cm. 67x73x34h, temp: 50÷300°C, mit 1 Rost cm.65x71 GN2/1 - Platte 39x73 cm - Neutrales Schrankelement mit Tür (inbegriffen 1 Abschluss-Element mod.TPC-9) • **FR** Toute plaque + 4 brûleurs sur Four électrique statique cm. 67x73x34h, temp: 50÷300°C, avec 1 grille cm.65x71 GN2/1 - Plaque cm. 39x73 - Element neutre avec porte (inclus 1 Élément de jonction top mod.TPC-9) • **ES PLACA DE COCCIÓN + 4 FUEGOS SOBRE HORNO ELÉCTRICO ESTÁTICO CM. 67X73X34H, TEMP: 50÷300°C, CON 1 PARILLA CM.65X71 GN2/1 - PLACA CM 39X73 - ARMARIO NEUTRO CON PUERTA (INCLUIDA 1 CHAPA DE CIERRE PARA TOP MOD.TPC-9) cm. 120x 90x 90h**



⚡ 35 kW **7.884,00**
30.100 kcal/h 245 / 1,32

⚡ 6,7 kW
400V~3N
50/60 Hz

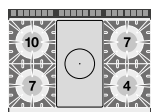

TUTTAPIASTRA A GAS CON FORNO ELETTRICO

MOD. _____
COD. _____

DESCRIZIONE/DESCRIPTION/BEZEICHNUNG/DESCRIPTION/DESCRIPCIÓN
DIMENSIONI/DIMENSIONS/ABMESSUNGEN/DIMENSIONS/DIMENSIONES

POTENZA/POWER/LEISTUNG/PUISSANCE/POTENCIA
VOLTAGGIO/VOLTAGE/SPANNUNG/VOLTAGE/VOLTAJE

⚡ kW kcal/h
⚡ kw V~ Hz

PREZZO/PRICE €
PREIS/PRIX/PRECIO €
KG / M³

TPFV4-912GEV TUTTA PIASTRA + 4 FUOCHI SU Forno elettrico ventilato cm. 55x36x34h, temp: 50÷300°C, con 1 griglia cm.53x32,5 GN1/1 - Piastra cm 39x73 - vano neutro con porta (inclusa 1 testata chiusura piano mod.TPC-9)
EN Solid top + 4 burners electric fan oven cm. 55x36x34h, temp: 50÷300°C, with 1 grid cm.53x32,5 GN1/1 - Plate 39x73 cm - Neutral cabinet with door (included 1 Head end filler strip mod.TPC-9) • **DE** Kochplatte + 4 Gaskochstellen - Elektro-Heißluftofen cm. 55x36x34h, temp: 50÷300°C, mit 1 Rost cm.53x32,5 GN1/1 - Platte 39x73 cm - Neutrales Schrankelement mit Tür (inbegriffen 1 Abschluss-Element mod. TPC-9) • **FR** Toute plaque + 4 brûleurs sur Four à chaleur tournante électrique cm. 55x36x34h, temp: 50÷300°C, avec 1 grille cm.53x32,5 GN1/1 - Plaque cm. 39x73 - Element neutre avec porte (inclus 1 Élément de jonction top mod.TPC-9) • **ES PLACA DE COCCIÓN + 4 FUEGOS SOBRE HORNO ELÉCTRICO VENTILADO CM. 55X36X34H, TEMP: 50÷300°C, CON 1 PARILLA CM.53X32,5 GN1/1 - PLACA CM 39X73 - ARMARIO NEUTRO CON PUERTA (INCLUIDA 1 CHAPA DE CIERRE PARA TOP MOD.TPC-9)**
cm. 120x 90x 90h



⚡ 35 kW 8.359,00
30.100 kcal/h 245 / 1,32
⚡ 5,32 kW
400V~3N
230V~3
50/60 Hz

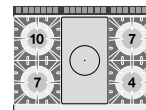

TPF4-912G TUTTA PIASTRA + 4 FUOCHI SU FORNO GAS statico cm. 107x73x34h, temp: 150÷300°C, con 1 griglia cm.105x71 - Piastra cm 39x73 (inclusa 1 testata chiusura piano mod.TPC-9)
EN Solid top + 4 burners Traditional gas-oven cm. 107x73x34h, temp: 150÷300°C, with 1 grid cm.105x71 - Plate 39x73 cm (included 1 Head end filler strip mod.TPC-9) • **DE** Kochplatte + 4 Gaskochstellen auf Statischer Gas-Backofen cm. 107x73x34h, temp: 150÷300°C, mit 1 Rost cm.105x71 - Platte 39x73 cm (inbegriffen 1 Abschluss-Element mod.TPC-9) • **FR** Toute plaque + 4 brûleurs sur Four à gaz statique cm. 107x73x34h, temp: 150÷300°C, avec 1 grille cm.105x71 - Plaque cm. 39x73 (inclus 1 Élément de jonction top mod.TPC-9) • **ES PLACA DE COCCIÓN + 4 FUEGOS SOBRE HORNO A GAS ESTÁTICO CM. 107X73X34H, TEMP: 150÷300°C, CON 1 PARILLA CM.105X71 - PLACA CM 39X73 (INCLUIDA 1 CHAPA DE CIERRE PARA TOP MOD.TPC-9)**
cm. 120x 90x 90h



⚡ 48 kW 8.253,00
41.280 kcal/h 259 / 1,32

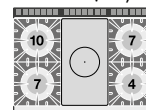

TPF4-912GE TUTTA PIASTRA + 4 FUOCHI SU Forno elettrico statico cm. 107x73x34h, temp: 50÷300°C, con 1 griglia cm.105x71 - Piastra cm 39x73 (inclusa 1 testata chiusura piano mod.TPC-9)
EN Solid top + 4 burners traditional electric oven cm. 107x73x34h, temp: 50÷300°C, with 1 grid cm.105x71 - Plate 39x73 cm (included 1 Head end filler strip mod.TPC-9) • **DE** Kochplatte + 4 Gaskochstellen auf Statischer Elektro-Backofen cm. 107x73x34h, temp: 50÷300°C, mit 1 Rost cm.105x71 - Platte 39x73 cm (inbegriffen 1 Abschluss-Element mod.TPC-9) • **FR** Toute plaque + 4 brûleurs sur Four électrique statique cm. 107x73x34h, temp: 50÷300°C, avec 1 grille cm.105x71 - Plaque cm. 39x73 (inclus 1 Élément de jonction top mod.TPC-9) • **ES PLACA DE COCCIÓN + 4 FUEGOS SOBRE HORNO ELÉCTRICO ESTÁTICO CM. 107X73X34H, TEMP: 50÷300°C, CON 1 PARILLA CM.105X71 - PLACA CM 39X73 (INCLUIDA 1 CHAPA DE CIERRE PARA TOP MOD.TPC-9)**
cm. 120x 90x 90h



⚡ 35 kW 8.402,00
30.100 kcal/h 255 / 1,32
⚡ 9,2 kW
400V~3N
50/60 Hz

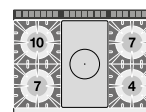

BM-94EM BAGNOMARIA MONOFASE SU MOBILE A GIORNO Vasca per GN 1/1 + GN 1/3 h. 15 Rubinetto carico acqua, scarico a pavimento (inclusa 1 testata chiusura piano mod.TPA-9)
EN Bain-marie singlephase on open cabinet - Bowl for GN 1/1 + GN 1/3 h.15 - Water loading tap floor draining (included 1 Head end filler strip mod.TPA-9) • **DE** Wasserbäder einphasig mit Offenem Unterbau - Becken GN 1/1 + GN 1/3 h.15 - Wasserlauf-Hahn, Ablauf am Boden (inbegriffen 1 Abschluss-Element mod.TPA-9) • **FR** Bain marie monophase sur armoire ouvert Cuve GN 1/1 + GN 1/3 h.15 Robinet d'arrivée d'eau - Système de vidange au sol (inclus 1 Élément de jonction top mod.TPA-9) • **ES BAÑO DE MARÍA MONOFÁSICO SOBRE MUEBLE ABIERTO CUBA PARA GN 1/1 + GN 1/3 15H GRIFO CARGA AGUA, DESCARGA A PAVIMENTO (INCLUIDA 1 CHAPA DE CIERRE PARA TOP MOD.TPA-9)**
cm. 40x 90x 90h



⚡ 2,85 KW 2.446,00
230V~ 52 / 0,46
50/60 Hz

BAGNOMARIA ELETTRICI

MOD. _____
COD. _____

DESCRIZIONE/DESCRIPTION/BEZEICHNUNG/DESCRIPTION/DESCRIPCIÓN
DIMENSIONI/DIMENSIONS/ABMESSUNGEN/DIMENSIONS/DIMENSIONES

POTENZA/POWER/LEISTUNG/PUISSANCE/POTENCIA ⚡ kW ⚡ kw PREZZO/PRICE €
VOLTAGGIO/VOLTAGE/SPANNUNG/VOLTAGE/VOLTAJE kcal/h V~ Hz PREIS/PRIX/PRECIO €
KG / M³

BM-98ET
09050830

BAGNOMARIA TRIFASE SU MOBILE A GIORNO - Vasca per GN 2/1 + 2 x GN 1/3 15h Rubinetto carico acqua + scarico a pavimento (inclusa 1 testata chiusura piano mod.TPA-9)
EN Bain-marie threephase on open cabinet - Bowl for GN 2/1 + 2 x GN 1/3 15h - Floor draining (included 1 Head end filler strip mod.TPA-9)
• **DE** Wasserbäder dreiphasig mit offenem Unterbau - Becken GN 2/1 + 2 x GN 1/3 15h - Ablauf am Boden (inbegriffen 1 Abschluss-Element mod.TPA-9) • **FR** Bain marie triphase sur armoire ouvert - Cuve GN 2/1 + 2 x GN 1/3 15h - Système de vidange au sol (inclus 1 Élément de jonction top mod.TPA-9) • **ES BAÑO DE MARÍA TRIFÁSICO SOBRE MUEBLE ABIERTO CUBA PARA GN 2/1 + 2 X GN 1/3 H.15 - DESCARGA A PAVIMENTO (INCLUIDA 1 CHAPA DE CIERRE PARA TOP MOD.TPA-9)**
cm. 80x 90x 90h



⚡ 5,7 kW
400V~3N
230V~3
50/60 Hz

3.302,00
76 / 0,89

BM-94G
09220450

BAGNOMARIA GAS SU MOBILE A GIORNO Vasca per GN 1/1 + GN 1/3 h.15 Rubinetto carico acqua, scarico a pavimento (inclusa 1 testata chiusura piano mod.TPA-9)
EN Gas bain-marie on open cabinet - Bowl for GN 1/1 + GN 1/3 h.15 - Water loading tap and floor draining (included 1 Head end filler strip mod.TPA-9) • **DE** Gas Wasserbad mit offenem Unterbau - Becken GN 1/1 + GN 1/3 h.15 - Wasserlauf-Hahn, Ablauf am Boden (inbegriffen 1 Abschluss-Element mod.TPA-9) • **FR** Bain-marie gaz sur armoire ouvert Cuve pour GN 1/1 + GN 1/3 h.15 Robinet d'arrivée d'eau, système de vidange au sol (inclus 1 Élément de jonction top mod.TPA-9) • **ES BAÑO DE MARÍA GAS SOBRE MUEBLE ABIERTO CUBA PARA GN 1/1 + GN 1/3 H.15 GRIFO CARGA AGUA, DESCARGA A PAVIMENTO (INCLUIDA 1 CHAPA DE CIERRE PARA TOP MOD.TPA-9)**
cm. 40x 90x 90h



⚡ 3,5 kW
3.010 kcal/h

2.648,00
56 / 0,46

BM-98G
09220850

BAGNOMARIA GAS SU MOBILE A GIORNO Vasca per GN 2/1 + 2 x GN 1/3 h.15 Rubinetto carico acqua, scarico a pavimento (inclusa 1 testata chiusura piano mod.TPA-9)
EN Gas bain-marie on open cabinet - Bowl for GN 2/1 + 2 x GN 1/3 h.15 - Water loading tap and floor draining (included 1 Head end filler strip mod.TPA-9) • **DE** Gas Wasserbad mit offenem Unterbau - Becken GN 2/1 + 2 x GN 1/3 h.15 - Wasserlauf-Hahn, Ablauf am Boden (inbegriffen 1 Abschluss-Element mod.TPA-9) • **FR** Bain-marie gaz sur armoire ouvert Cuve pour GN 2/1 + 2 x GN 1/3 h.15 Robinet d'arrivée d'eau, système de vidange au sol (inclus 1 Élément de jonction top mod.TPA-9) • **ES BAÑO DE MARÍA GAS SOBRE MUEBLE ABIERTO CUBA PARA GN 2/1 + 2 X GN 1/3 H.15 GRIFO CARGA AGUA, DESCARGA A PAVIMENTO (INCLUIDA 1 CHAPA DE CIERRE PARA TOP MOD.TPA-9)**
cm. 80x 90x 90h



⚡ 6,5 kW
5.590 kcal/h

3.832,00
81 / 0,89

BS-94EM
09040410

CONTENITORE CALDO CON INFRAROSSO, MONOFASE SU MOBILE A GIORNO Vasca cm. 30,5x51x16,5h con falsofondo forato (inclusa 1 testata chiusura piano mod.TPA-9)
EN Fry dump singlephase with infra-red heater on open cabinet. Bowl cm. 30,5x51x16,5h with perforated double bottom (included 1 Head end filler strip mod.TPA-9) • **DE** Frittenwanne Einphasig mit Infrarotstrahler mit offenem Unterbau. Becke cm. 30,5x51x16,5h mit gelochtem Bodenrost (inbegriffen 1 Abschluss-Element mod.TPA-9) • **FR** Silo a frites monophasé avec infrarouge sur armoire ouvert. Cuve cm 30,5x51x16,5h avec double-fond perforé. (inclus 1 Élément de jonction top mod.TPA-9) • **ES CONTENEDOR CALIENTE POR INFRARROJO, MONOFÁSICO Y SOBRE MUEBLE ABIERTO. CUBA CM. 30,5X51X16,5H CON FALSO FONDO AGUJEREO (INCLUIDA 1 CHAPA DE CIERRE PARA TOP MOD.TPA-9)**
cm. 40x 90x 90h



⚡ 1,47 kW
230V~
50/60 Hz

2.515,00
60 / 0,46

CUOCIPASTA ELETTRICI

MOD. _____
COD. _____

DESCRIZIONE/DESCRIPTION/BEZEICHNUNG/DESCRIPTION/DESCRIPCIÓN
DIMENSIONI/DIMENSIONS/ABMESSUNGEN/DIMENSIONS/DIMENSIONES

POTENZA/POWER/LEISTUNG/PUISSANCE/POTENCIA
VOLTAGGIO/VOLTAGE/SPANNUNG/VOLTAGE/VOLTAJE

⚡ kW
kcal/h

⚡ kw
V~
Hz

PREZZO/PRICE €
PREIS/PRIX/PRECIO €
KG / M³

CP-94ET
09100430

CUOCIPASTA TRIFASE LT. 40 Vasca cm. 30,7x50,9x32,7h. Rubinetto carico acqua, sfioratore + scarico a pavimento (CESTI ESCLUSI) (inclusa 1 testata chiusura piano mod.TPA-9)

EN Pasta cooker threephase 40 lts. Tank cm. 30,7x50,9x32,7h. Water loading tap + overflow device and floor draining (BASKETS EXCLUDED) (included 1 Head end filler strip mod.TPA-9) • **DE** Nudelkocher dreiphasig lt. 40 - Becken cm. 30,7x50,9x32,7h. Wasserlauf-Hahn + Überlauf-Vorrichtung und Ablauf am Boden (KORB AUSGESCHLOSSEN) (inbegriffen 1 Abschluss-Element mod.TPA-9) • **FR** Cuiseur a pates triphase lt. 40 Cuve cm.30,7x50,9x32,7h. Robinet d'arrivée d'eau trop plein + système de vidange au sol (PANIERS EXCLUS) (inclus 1 Élément de jonction top mod.TPA-9) • **ES CUECE PASTA TRIFÁSICO LT. 40 - CUBA CM. 30,7X50,9X32,7H. GRIFO CARGA AGUA + VERTEDERO + DESCARGA A PAVIMENTO (CESTAS EXCLUIDAS) (INCLUIDA 1 CHAPA DE CIERRE PARA TOP MOD.TPA-9)**

cm. 40x 90x 90h



⚡ 13,5 kW
400V~3N
50/60 Hz

3.822,00
57 / 0,46

COMBINAZIONI

- Combinations / • Zusammenstellungen
- Combinaisons / • Combinación múltiple

1/1	1/2	1/3	1/3	1/6 1/6	1/6 1/6
	1/2	1/3	2/3	1/3	1/6 1/6
		1/3		1/3	1/6 1/6

CPA-94ET
09100435

CUOCIPASTA TRIFASE LT. 40 Vasca cm. 30,7x50,9x32,7h. Carico acqua automatico con sensore di livello - sfioratore + scarico a pavimento (CESTI ESCLUSI) (inclusa 1 testata chiusura piano mod.TPA-9)

EN Pasta cooker threephase 40 lts. Tank cm. 30,7x50,9x32,7h. Automatic Water loading with level sensor - overflow device and floor draining (BASKETS EXCLUDED) (included 1 Head end filler strip mod.TPA-9) • **DE** Nudelkocher dreiphasig lt. 40 - Becken cm. 30,7x50,9x32,7h. Automatische Wasser Beladung mit Niveauregulierung + Überlauf-Vorrichtung und Ablauf am Boden (KORB AUSGESCHLOSSEN) (inbegriffen 1 Abschluss-Element mod.TPA-9) • **FR** Cuiseur a pates triphase lt. 40 Cuve cm.30,7x50,9x32,7h. Chargement automatique de l'eau avec sensor de niveau, trop plein Système de vidange au sol (PANIERS EXCLUS) (inclus 1 Élément de jonction top mod.TPA-9) • **ES CUECE PASTA TRIFÁSICO LT. 40 - CUBA CM. 30,7X50,9X32,7H.CARGA AUTOMÁTICA DE AGUA CON SENSOR DE NIVEL + VERTEDERO + DESCARGA A PAVIMENTO. (CESTAS EXCLUIDAS) (INCLUIDA 1 CHAPA DE CIERRE PARA TOP MOD.TPA-9)**

cm. 40x 90x 90h



⚡ 13,5 kW
400V~3N
50/60 Hz

4.317,00
57 / 0,46

COMBINAZIONI

- Combinations / • Zusammenstellungen
- Combinaisons / • Combinación múltiple

1/1	1/2	1/3	1/3	1/6 1/6	1/6 1/6
	1/2	1/3	2/3	1/3	1/6 1/6
		1/3		1/3	1/6 1/6

CUOCIPASTA ELETTRICI

MOD. _____
COD. _____

DESCRIZIONE/DESCRIPTION/BEZEICHNUNG/DESCRIPTION/DESCRIPCIÓN
DIMENSIONI/DIMENSIONS/ABMESSUNGEN/DIMENSIONS/DIMENSIONES

POTENZA/POWER/LEISTUNG/PUISSANCE/POTENCIA
VOLTAGGIO/VOLTAGE/SPANNUNG/VOLTAGE/VOLTAJE

⚡ kW _____
kcal/h _____
V~ _____
Hz _____

PREZZO/PRICE € _____
PREIS/PRIX/PRECIO _____
KG / M³ _____

CP-98ET
09100830

CUOCIPASTA TRIFASE LT. 40+40 2 Vasche cm. 30,7x50,9x32,7h.
Rubinetto carico acqua, sfioratore + scarico a pavimento (CESTI ESCLUSI)
(inclusa 1 testata chiusura piano mod.TPA-9)
EN Pasta cooker threephase 40+40 lts. 2 Tanks cm. 30,7x50,9x32,7h.
Water loading tap + overflow device and floor draining (BASKETS
EXCLUDED) (included 1 Head end filler strip mod.TPA-9) • **DE**
Nudelkocher dreiphasig lt. 40+40 2 Becken cm. 30,7x50,9x32,7h.
Wasserlauf-Hahn + Überlauf-Vorrichtung und Ablauf am Boden (KORB
AUSGESCHLOSSEN) (inbegriffen 1 Abschluss-Element mod.TPA-9) • **FR**
Cuiseur a pates triphase lt. 40+40 2 Cuves cm.30,7x50,9x32,7h. Robinet
d'arrivée d'eau trop plein + système de vidange au sol (PANIERS EXCLUS)
(inclus 1 Élément de jonction top mod.TPA-9) • **ES CUECE PASTA
TRIFÁSICO 40+40 LT. 2 CUBAS CM. 30,7X50,9X32,7H.
GRIFO CARGA AGUA + VERTEDERO + DESCARGA A
PAVIMENTO (CESTAS EXCLUIDAS) (INCLUIDA 1 CHAPA DE
CIERRE PARA TOP MOD.TPA-9)**
cm. 80x 90x 90h



⚡ 27 kW _____ **6.384,00**
400V~3N _____ 98 / 0,89
50/60 Hz _____

COMBINAZIONI

- Combinations / • Zusammenstellungen
- Combinaisons / • Combinación múltiple

1/1	1/2	1/3	1/3	1/6 1/6	1/6 1/6
	1/2	1/3	2/3	1/3	1/6 1/6
		1/3		1/3	1/6 1/6

CPA-98ET
09100835

CUOCIPASTA TRIFASE LT. 40+40 2 Vasche cm. 30,7x50,9x32,7h. Carico
acqua automatico con sensore di livello - sfioratore + scarico a pavimento
(CESTI ESCLUSI) (inclusa 1 testata chiusura piano mod.TPA-9)
EN Pasta cooker threephase 40+40 lts. 2 Tanks cm. 30,7x50,9x32,7h.
Automatic Water loading with level sensor - overflow device and
floor draining (BASKETS EXCLUDED) (included 1 Head end filler strip
mod.TPA-9) • **DE** Nudelkocher dreiphasig lt. 40+40 2 Becken cm.
30,7x50,9x32,7h. Automatische Wasser Beladung mit Niveauregulierung
+ Überlauf-Vorrichtung und Ablauf am Boden (KORB AUSGESCHLOSSEN)
(inbegriffen 1 Abschluss-Element mod.TPA-9) • **FR** Cuiseur a pates
triphase lt. 40+40 2 Cuves cm.30,7x50,9x32,7h. Chargement
automatique de l'eau avec sensor de niveau, trop plein Système de
vidange au sol (PANIERS EXCLUS) (inclus 1 Élément de jonction top mod.
TPA-9) • **ES CUECE PASTA TRIFÁSICO 40+40 LT. 2 CUBAS
CM. 30,7X50,9X32,7H. CARGA AUTOMÁTICA DE AGUA
CON SENSOR DE NIVEL + VERTEDERO + DESCARGA A
PAVIMENTO. (CESTAS EXCLUIDAS) (INCLUIDA 1 CHAPA DE
CIERRE PARA TOP MOD.TPA-9)**
cm. 80x 90x 90h



⚡ 27 kW _____ **7.377,00**
400V~3N _____ 98 / 0,89
50/60 Hz _____

COMBINAZIONI

- Combinations / • Zusammenstellungen
- Combinaisons / • Combinación múltiple

1/1	1/2	1/3	1/3	1/6 1/6	1/6 1/6
	1/2	1/3	2/3	1/3	1/6 1/6
		1/3		1/3	1/6 1/6

CUOCIPASTA ELETTRICI

MOD. _____
COD. _____

DESCRIZIONE/DESCRIPTION/BEZEICHNUNG/DESCRIPTION/DESCRIPCIÓN
DIMENSIONI/DIMENSIONS/ABMESSUNGEN/DIMENSIONS/DIMENSIONES

POTENZA/POWER/LEISTUNG/PUISSANCE/POTENCIA
VOLTAGGIO/VOLTAGE/SPANNUNG/VOLTAGE/VOLTAJE

⚡ kW
kcal/h

⚡ kw
V~
Hz

PREZZO/PRICE €
PREIS/PRIX/PRECIO €
KG / M³

CPB-98ET
09100831

CUOCIPASTA TRIFASE LT. 80 Vasca cm. 62x50,9x32,7h. Rubinetto carico acqua, sfioratore + scarico a pavimento (CESTI ESCLUSI) (inclusa 1 testata chiusura piano mod.TPA-9)

EN Pasta cooker threephase 80 lts. - Tank cm. 62x50,9x32,7h. Water loading tap + overflow device and floor draining (BASKETS EXCLUDED) (included 1 Head end filler strip mod.TPA-9) • **DE** Nudelkocher dreiphasig lt. 80 - Becken cm. 62x50,9x32,7h. Wasserlauf-Hahn + Überlauf-Vorrichtung und Ablauf am Boden (KORB AUSGESCHLOSSEN) (inbegriffen 1 Abschluss-Element mod.TPA-9) • **FR** Cuiseur a pates triphase lt. 80 - Cuve cm. 62x50,9x32,7h. Robinet d'arrivée d'eau trop plein + système de vidange au sol (PANIERS EXCLUS) (inclus 1 Élément de jonction top mod.TPA-9) • **ES CUECE PASTA TRIFÁSICO LT. 80 - CUBA CM. 62X50,9X32,7H. GRIFO CARGA AGUA + VERTEDERO + DESCARGA A PAVIMENTO (CESTAS EXCLUIDAS) (INCLUIDA 1 CHAPA DE CIERRE PARA TOP MOD.TPA-9)**

cm. 80x 90x 90h



⚡ 27 kW
400V~3N
50/60 Hz

5.818,00
93 / 0,89

COMBINAZIONI

- Combinations / • Zusammenstellungen
- Combinaisons / • Combinación múltiple

1/1	1/2	1/3	1/3	1/6/1/6	1/6/1/6
	1/2	1/3	2/3	1/3	1/6/1/6
		1/3		1/3	1/6/1/6

CP-94G
09270450

CUOCIPASTA GAS LT. 40 Vasca cm. 30,7x50,9x32,7h. Rubinetto carico acqua, sfioratore + scarico a pavimento (CESTI ESCLUSI) (inclusa 1 testata chiusura piano mod.TPA-9)

EN Gas pasta cooker 40 lts. - Tank cm. 30,7x50,9x32,7h. Water loading tap + overflow device and floor draining (BASKETS EXCLUDED) (included 1 Head end filler strip mod.TPA-9) • **DE** Gas-Nudelkocher lt. 40 - Becken cm. 30,7x50,9x32,7h. Wasserlauf-Hahn + Überlauf-Vorrichtung und Ablauf am Boden (KORB AUSGESCHLOSSEN) (inbegriffen 1 Abschluss-Element mod.TPA-9) • **FR** Cuiseur a pates gaz lt. 40 - Cuve cm.30,7x50,9x32,7h. Robinet d'arrivée d'eau trop plein Système de vidange au sol (PANIERS EXCLUS) (inclus 1 Élément de jonction top mod.TPA-9) • **ES CUECE PASTA GAS 40 LT. - CUBA CM. 30,7X50,9X32,7H. GRIFO CARGA AGUA + VERTEDERO + DESCARGA A PAVIMENTO. (CESTAS EXCLUIDAS) (INCLUIDA 1 CHAPA DE CIERRE PARA TOP MOD.TPA-9)**

cm. 40x 90x 90h



⚡ 13,95 kW
11.997 kcal/h

4.004,00
68 / 0,46

⚡ 0,02 KW
230V~
50/60 Hz

COMBINAZIONI

- Combinations / • Zusammenstellungen
- Combinaisons / • Combinación múltiple

1/1	1/2	1/3	1/3	1/6/1/6	1/6/1/6
	1/2	1/3	2/3	1/3	1/6/1/6
		1/3		1/3	1/6/1/6

CUOCIPASTA A GAS

MOD. _____
COD. _____

DESCRIZIONE/DESCRIPTION/BEZEICHNUNG/DESCRIPTION/DESCRIPCIÓN
DIMENSIONI/DIMENSIONS/ABMESSUNGEN/DIMENSIONS/DIMENSIONES

POTENZA/POWER/LEISTUNG/PUISSANCE/POTENCIA ⚡ kW ⚡ kw ⚡ PREZZO/PRICE €
VOLTAGGIO/VOLTAGE/SPANNUNG/VOLTAGE/VOLTAJE kcal/h kcal/h PREIS/PRIX/PRECIO €
Hz V~ Hz KG / M³

CPA-94G
09270455

CUOCIPASTA GAS LT. 40 Vasca cm. 30,7x50,9x32,7h. Carico acqua automatico con sensore di livello - sfioratore + scarico a pavimento (CESTI ESCLUSI) (inclusa 1 testata chiusura piano mod.TPA-9)
EN Gas pasta cooker 40 lts. - Tank cm. 30,7x50,9x32,7h. Automatic Water loading with level sensor - overflow device and floor draining (BASKETS EXCLUDED) (included 1 Head end filler strip mod.TPA-9) • **DE** Gas-Nudelkocher lt. 40 - Becken cm. 30,7x50,9x32,7h. Automatische Wasser Beladung mit Niveauregulierung + Überlauf-Vorrichtung und Ablauf am Boden (KORB AUSGESCHLOSSEN) (inbegriffen 1 Abschluss-Element mod.TPA-9) • **FR** Cuiseur a pates gaz lt. 40 - Cuve cm.30,7x50,9x32,7h. Chargement automatique de l'eau avec sensor de niveau, trop plein Système de vidange au sol (PANIERS EXCLUS) (inclus 1 Élément de jonction top mod.TPA-9) • **ES CUECE PASTA GAS 40 LT. - CUBA CM. 30,7X50,9X32,7H. CARGA AUTOMÁTICA DE AGUA CON SENSOR DE NIVEL + VERTEDERO + DESCARGA A PAVIMENTO. (CESTAS EXCLUIDAS) (INCLUIDA 1 CHAPA DE CIERRE PARA TOP MOD.TPA-9)**
cm. 40x 90x 90h



⚡ 13,95 kW **4.291,00**
11.997 kcal/h 68 / 0,46
⚡ 0,035 KW
230V~
50/60 Hz

COMBINAZIONI

- Combinations / • Zusammenstellungen
- Combinaisons / • Combinación múltiple

1/1	1/2	1/3	1/3	1/6/1/6	1/6/1/6
	1/2	1/3	2/3	1/3	1/6/1/6
		1/3		1/3	1/6/1/6

CP-98G
09270850

CUOCIPASTA GAS LT. 40+40 2 Vasche cm. 30,7x50,9x32,7h. Rubinetto carico acqua, sfioratore + scarico a pavimento (CESTI ESCLUSI) (inclusa 1 testata chiusura piano mod.TPA-9)
EN Gas pasta cooker 40+40 lts 2 Tanks cm. 30,7x50,9x32,7h. Water loading, tap + overflow device and floor draining (BASKETS EXCLUDED) (included 1 Head end filler strip mod.TPA-9) • **DE** Gas-Nudelkocher lt. 40+40 2 Becken cm. 30,7x50,9x32,7h. Wasserlauf-Hahn, Überlauf-Vorrichtung und Ablauf am Boden (KORB AUSGESCHLOSSEN) (inbegriffen 1 Abschluss-Element mod.TPA-9) • **FR** Cuiseur a pates gaz lt. 40+40 2 Cuve cm. 30,7x50,9x32,7h. Robinet d'arrivée d'eau trop plein + système de vidange au sol (PANIERS EXCLUS) (inclus 1 Élément de jonction top mod.TPA-9) • **ES CUECE PASTA GAS 40+40 LT. 2 CUBAS CM. 30,7X50,9X32,7H. GRIFO CARGA AGUA + VERTEDERO + DESCARGA A PAVIMENTO (CESTAS EXCLUIDAS) (INCLUIDA 1 CHAPA DE CIERRE PARA TOP MOD.TPA-9)**
cm. 80x 90x 90h



⚡ 27,9 kW **6.771,00**
23.994 kcal/h 116 / 0,89
⚡ 0,04 KW
230V~
50/60 Hz

COMBINAZIONI

- Combinations / • Zusammenstellungen
- Combinaisons / • Combinación múltiple

1/1	1/2	1/3	1/3	1/6/1/6	1/6/1/6
	1/2	1/3	2/3	1/3	1/6/1/6
		1/3		1/3	1/6/1/6

CUOCIPASTA A GAS

MOD. _____
COD. _____

DESCRIZIONE/DESCRIPTION/BEZEICHNUNG/DESCRIPTION/DESCRIPCIÓN
DIMENSIONI/DIMENSIONS/ABMESSUNGEN/DIMENSIONS/DIMENSIONES

POTENZA/POWER/LEISTUNG/PUISSANCE/POTENCIA
VOLTAGGIO/VOLTAGE/SPANNUNG/VOLTAGE/VOLTAJE

⚡ kW
kcal/h

⚡ kW
V~
Hz

PREZZO/PRICE €
PREIS/PRIX/PRECIO
KG / M³

CPA-98G
09270855

CUOCIPASTA GAS LT. 40+40 2 Vasche cm. 30,7x50,9x32,7h. Carico acqua automatico con sensore di livello - sfioratore + scarico a pavimento (CESTI ESCLUSI) (inclusa 1 testata chiusura piano mod.TPA-9)
EN Gas pasta cooker 40+40 lts 2 Tanks cm. 30,7x50,9x32,7h. Automatic Water loading with level sensor - overflow device and floor draining (BASKETS EXCLUDED) (included 1 Head end filler strip mod.TPA-9) • **DE** Gas-Nudelkocher lt. 40+40 2 Becken cm. 30,7x50,9x32,7h. Automatische Wasser Beladung mit Niveauregulierung + Überlauf-Vorrichtung und Ablauf am Boden (KORB AUSGESCHLOSSEN) (inbegriffen 1 Abschluss-Element mod.TPA-9) • **FR** Cuiseur a pates gaz lt. 40+40 2 Cuve cm. 30,7x50,9x32,7h. Chargement automatique de l'eau avec sensor de niveau, trop plein Système de vidange au sol (PANIERS EXCLUS) (inclus 1 Élément de jonction top mod.TPA-9) • **ES CUECE PASTA GAS 40+40 LT. 2 CUBAS CM. 30,7X50,9X32,7H. CARGA AUTOMÁTICA DE AGUA CON SENSOR DE NIVEL + VERTEDERO + DESCARGA A PAVIMENTO. (CESTAS EXCLUIDAS) (INCLUIDA 1 CHAPA DE CIERRE PARA TOP MOD.TPA-9)**
cm. 80x 90x 90h



⚡ 27,9 kW **7.343,00**
23.994 kcal/h 116 / 0,89
⚡ 0,07 KW
230V~
50/60 Hz

COMBINAZIONI

- Combinations / • Zusammenstellungen
- Combinaisons / • Combinación múltiple

1/1	1/2	1/3	1/3	1/6/1/6	1/6/1/6
	1/2	1/3	2/3	1/3	1/6/1/6
		1/3		1/3	1/6/1/6

CPB-98G
09270851

CUOCIPASTA GAS LT. 80 Vasca cm. 62x50,9x32,7h. Rubinetto carico acqua, sfioratore + scarico a pavimento (CESTI ESCLUSI) (inclusa 1 testata chiusura piano mod.TPA-9)
EN Gas pasta cooker 80 lts. - Tank cm. 62x50,9x32,7h. Water loading tap + overflow device and floor draining (BASKETS EXCLUDED) (included 1 Head end filler strip mod.TPA-9) • **DE** Gas-Nudelkocher lt. 80 - Becken cm. 62x50,9x32,7h. Wasserlauf-Hahn + Überlauf-Vorrichtung und Ablauf am Boden (KORB AUSGESCHLOSSEN) (inbegriffen 1 Abschluss-Element mod.TPA-9) • **FR** Cuiseur a pates gaz lt. 80 - Cuve cm. 62x50,9x32,7h. Robinet d'arrivée d'eau trop plein + système de vidange au sol (PANIERS EXCLUS) (inclus 1 Élément de jonction top mod.TPA-9) • **ES CUECE PASTA GAS 80 LT. - CUBA CM. 62X50,9X32,7H. GRIFO CARGA AGUA + VERTEDERO + DESCARGA A PAVIMENTO (CESTAS EXCLUIDAS) (INCLUIDA 1 CHAPA DE CIERRE PARA TOP MOD.TPA-9)**
cm. 80x 90x 90h



⚡ 31,5 kW **5.972,00**
27.060 kcal/h 110 / 0,89
⚡ 0,02 KW
230V~
50/60 Hz

COMBINAZIONI

- Combinations / • Zusammenstellungen
- Combinaisons / • Combinación múltiple

1/1	1/2	1/3	1/3	1/6/1/6	1/6/1/6
	1/2	1/3	2/3	1/3	1/6/1/6
		1/3		1/3	1/6/1/6

CUOCIPASTA A GAS POTENZIATO

MOD. _____
COD. _____

DESCRIZIONE/DESCRIPTION/BEZEICHNUNG/DESCRIPTION/DESCRIPCIÓN
DIMENSIONI/DIMENSIONS/ABMESSUNGEN/DIMENSIONS/DIMENSIONES

POTENZA/POWER/LEISTUNG/PUISSANCE/POTENCIA $\frac{\text{kW}}{\text{kcal/h}}$ $\frac{\text{kW}}{\text{V-}}$ $\frac{\text{Hz}}{\text{Hz}}$ PREZZO/PRICE €
VOLTAGGIO/VOLTAGE/SPANNUNG/VOLTAGE/VOLTAGE $\frac{\text{€}}{\text{KG / M}^3}$ PREIS/PRIX/PRECIO

CPP-94G
09270452

CUOCIPASTA GAS POTENZIATO LT. 40 Vasca cm. 30,7x50,9x32,7h.
Rubinetto carico acqua, sfioratore + scarico a pavimento (CESTI ESCLUSI)
(includo entrambe le testate chiusura piano)
EN Powerfull Gas pasta cooker 40 lts. - Tank cm. 30,7x50,9x32,7h.
Water loading tap + overflow device and floor draining (BASKETS
EXCLUDED) (included both Heads end filler strip) • **DE** Gas-Nudelkocher
leistungsfähiges lt. 40 - Becken cm. 30,7x50,9x32,7h. Wasserlauf-Hahn +
Überlauf-Vorrichtung und Ablauf am Boden (KORB AUSGESCHLOSSEN)
(inbegriffen alle 2 Abschluss-Element) • **FR** Cuisneur a pates gaz plus
puissants lt. 40 - Cuve cm.30,7x50,9x32,7h. Robinet d'arrivée d'eau
trop plein Système de vidange au sol (PANIERS EXCLUS) (inclus tous 2
Élément de jonction top) • **ES CUECE PASTA GAS CON MAYOR
POTENCIA 40 LT. - CUBA CM. 30,7X50,9X32,7H. GRIFO
CARGA AGUA + VERTEDERO + DESCARGA A PAVIMENTO.
(CESTAS EXCLUIDAS) (INCLUIDAS TODAS LAS 2 CHAPA DE
CIERRE PARA TOP)**
cm. 40x 90x 90h



23,5 kW **4.545,00**
20.210 kcal/h 69 / 0,54
0,02 KW
230V~
50/60 Hz

COMBINAZIONI

- Combinations / • Zusammenstellungen
- Combinaisons / • Combinación múltiple

1/1	1/2	1/3	1/3	1/6 1/6	1/6 1/6
	1/2	1/3	2/3	1/3	1/6 1/6
		1/3		1/3	1/6 1/6

CPPA-94G
09270457

CUOCIPASTA GAS POTENZIATO LT. 40 Vasca cm. 30,7x50,9x32,7h.
Carico acqua automatico con sensore di livello - sfioratore + scarico a
pavimento (CESTI ESCLUSI) (includo entrambe le testate chiusura piano)
EN Powerfull Gas pasta cooker 40 lts. - Tank cm. 30,7x50,9x32,7h.
Automatic Water loading with level sensor - overflow device and
floor draining (BASKETS EXCLUDED) (included both Heads end filler
strip) • **DE** Gas-Nudelkocher leistungsfähiges lt. 40 - Becken cm.
30,7x50,9x32,7h. Automatische Wasser Beladung mit Niveauregulierung
+ Überlauf-Vorrichtung und Ablauf am Boden (KORB AUSGESCHLOSSEN)
(inbegriffen alle 2 Abschluss-Element) • **FR** Cuisneur a pates gaz plus
puissants lt. 40 - Cuve cm.30,7x50,9x32,7h. Chargement automatique
de l'eau avec sensor de niveau, trop plein Système de vidange au
sol (PANIERS EXCLUS) (inclus tous 2 Élément de jonction top) • **ES
CUECE PASTA GAS CON MAYOR POTENCIA 40 LT. - CUBA
CM. 30,7X50,9X32,7H. CARGA AUTOMÁTICA DE AGUA
CON SENSOR DE NIVEL + VERTEDERO + DESCARGA A
PAVIMENTO. (CESTAS EXCLUIDAS) (INCLUIDAS TODAS LAS
2 CHAPA DE CIERRE PARA TOP)**
cm. 40x 90x 90h



23,5 kW **4.823,00**
20.210 kcal/h 69 / 0,54
0,035 KW
230V~
50/60 Hz

COMBINAZIONI

- Combinations / • Zusammenstellungen
- Combinaisons / • Combinación múltiple

1/1	1/2	1/3	1/3	1/6 1/6	1/6 1/6
	1/2	1/3	2/3	1/3	1/6 1/6
		1/3		1/3	1/6 1/6

CUOCIPASTA A GAS POTENZIATO

MOD. _____
COD. _____

DESCRIZIONE/DESCRIPTION/BEZEICHNUNG/DESCRIPTION/DESCRIPCIÓN
DIMENSIONI/DIMENSIONS/ABMESSUNGEN/DIMENSIONS/DIMENSIONES

POTENZA/POWER/LEISTUNG/PUISSANCE/POTENCIA
VOLTAGGIO/VOLTAGE/SPANNUNG/VOLTAGE/VOLTAJE

⚡ kW kcal/h
⚡ kW V~ Hz

PREZZO/PRICE €
PREIS/PRIX/PRECIO €
KG / M³

CPP-98G
09270852

CUOCIPASTA GAS POTENZIATO LT. 40+40 2 Vasche cm. 30,7x50,9x32,7h. Rubinetto carico acqua, sfioratore + scarico a pavimento (CESTI ESCLUSI) (incluse entrambe le testate chiusura piano)
EN Powerfull Gas pasta cooker 40+40 lts 2 Tanks cm. 30,7x50,9x32,7h. Water loading tap + overflow device and floor draining (BASKETS EXCLUDED) (included both Heads end filler strip) • **DE** Gas-Nudelkocher leistungsfähiges lt. 40+40 2 Becken cm. 30,7x50,9x32,7h. Wasserlauf-Hahn + Überlauf-Vorrichtung und Ablauf am Boden (KORB AUSGESCHLOSSEN) (inbegriffen alle 2 Abschluss-Element) • **FR** Cuiseur a pates gaz plus puissants lt. 40+40 2 Cuve cm.30,7x50,9x32,7h. Robinet d'arrivée d'eau trop plein Système de vidange au sol (PANIERS EXCLUS) (inclus tous 2 Elément de jonction top) • **ES CUECE PASTA GAS CON MAYOR POTENCIA 40+40 LT. 2 CUBAS CM. 30,7X50,9X32,7H. GRIFO CARGA AGUA + VERTEDERO + DESCARGA A PAVIMENTO. (CESTAS EXCLUIDAS) (INCLUIDAS TODAS LAS 2 CHAPA DE CIERRE PARA TOP) cm. 80x 90x 90h**



⚡ 47 kW **8.261,00**
40.420 kcal/h 118 / 1,05
⚡ 0,04 KW
230V~
50/60 Hz

COMBINAZIONI

- Combinations / • Zusammenstellungen
- Combinaisons / • Combinación múltiple

1/1	1/2	1/3	1/3	1/6/1/6	1/6/1/6
	1/2	1/3	2/3	1/3	1/6/1/6
		1/3		1/3	1/6/1/6

CPPA-98G
09270857

CUOCIPASTA GAS POTENZIATO LT. 40+40 2 Vasche cm. 30,7x50,9x32,7h. Carico acqua automatico con sensore di livello - sfioratore + scarico a pavimento (CESTI ESCLUSI) (incluse entrambe le testate chiusura piano)
EN Powerfull Gas pasta cooker 40+40 lts 2 Tanks cm. 30,7x50,9x32,7h. Automatic Water loading with level sensor - overflow device and floor draining (BASKETS EXCLUDED) (included both Heads end filler strip) • **DE** Gas-Nudelkocher leistungsfähiges lt. 40+40 2 Becken cm. 30,7x50,9x32,7h. Automatische Wasser Beladung mit Niveauregulierung + Überlauf-Vorrichtung und Ablauf am Boden (KORB AUSGESCHLOSSEN) (inbegriffen alle 2 Abschluss-Element) • **FR** Cuiseur a pates gaz plus puissants lt. 40+40 2 Cuve cm.30,7x50,9x32,7h. Chargement automatique de l'eau avec sensor de niveau, trop plein Système de vidange au sol (PANIERS EXCLUS) (inclus tous 2 Elément de jonction top) • **ES CUECE PASTA GAS CON MAYOR POTENCIA 40+40 LT. 2 CUBAS CM. 30,7X50,9X32,7H. CARGA AUTOMÁTICA DE AGUA CON SENSOR DE NIVEL + VERTEDERO + DESCARGA A PAVIMENTO. (CESTAS EXCLUIDAS) (INCLUIDAS TODAS LAS 2 CHAPA DE CIERRE PARA TOP) cm. 80x 90x 90h**



⚡ 47 kW **9.020,00**
40.420 kcal/h 118 / 1,05
⚡ 0,07 KW
230V~
50/60 Hz

COMBINAZIONI

- Combinations / • Zusammenstellungen
- Combinaisons / • Combinación múltiple

1/1	1/2	1/3	1/3	1/6/1/6	1/6/1/6
	1/2	1/3	2/3	1/3	1/6/1/6
		1/3		1/3	1/6/1/6

SOLLEVATORE CESTI

MOD. _____
COD. _____

DESCRIZIONE/DESCRIPTION/BEZEICHNUNG/DESCRIPTION/DESCRIPCIÓN
DIMENSIONI/DIMENSIONS/ABMESSUNGEN/DIMENSIONS/DIMENSIONES

POTENZA/POWER/LEISTUNG/PUISSANCE/POTENCIA
VOLTAGGIO/VOLTAGE/SPANNUNG/VOLTAGE/VOLTAJE

⚡ kW _____
kcal/h _____
V~ _____
Hz _____

PREZZO/PRICE €
PREIS/PRIX/PRECIO €
KG / M³

SCCP-92EM SOLLEVATORE CESTI DA AFFIANCARE AI CUOCIPASTA CP-94/98,
09140210 sollevamento automatico temporizzato o manuale, 3 aste (inclusa 1 testata
chiusura piano mod.TPA-9)

EN basket elevator for pasta cooker CP-94/98, automatic timed or manual lifting, 3 rods (included 1 Head end filler strip mod.TPA-9) • **DE** heben Korbe für Nudelkocher CP-94/98, Timed oder manuelle Heben, 3 Stangen (inbegriffen 1 Abschluss-Element mod.TPA-9) • **FR** soulever des paniers pour cuiseur a pates CP-94/98, soulèvement temporisé ou manuel, 3 tiges (inclus 1 Elément de jonction top mod.TPA-9) • **ES LEVANTE CESTAS PARA CUECE PASTA CP-94/98, ELEVACIÓN TEMPORIZADO O MANUAL, 3 BARRAS (INCLUIDA 1 CHAPA DE CIERRE PARA TOP MOD.TPA-9)**

cm. 20x 90x 90h

COMBINAZIONI

- Combinations / • Zusammenstellungen
- Combinaisons / • Combinación múltiple



⚡ 0,525 KW _____ **4.716,00**
230V~ _____ 65 / 0,46
50/60 Hz

SCCPB-92EM SOLLEVATORE CESTI DA AFFIANCARE AI CUOCIPASTA CPB-98,
09140211 sollevamento automatico temporizzato o manuale, 3 aste (inclusa 1 testata
chiusura piano mod.TPA-9)

EN basket elevator for pasta cooker CPB-98, automatic timed or manual lifting, 3 rods (included 1 Head end filler strip mod.TPA-9) • **DE** heben Korbe für Nudelkocher CPB-98, Timed oder manuelle Heben, 3 Stangen (inbegriffen 1 Abschluss-Element mod.TPA-9) • **FR** soulever des paniers pour cuiseur a pates CPB-98, soulèvement temporisé ou manuel, 3 tiges (inclus 1 Elément de jonction top mod.TPA-9) • **ES LEVANTE CESTAS PARA CUECE PASTA CPB-98, ELEVACIÓN TEMPORIZADO O MANUAL, 3 BARRAS (INCLUIDA 1 CHAPA DE CIERRE PARA TOP MOD.TPA-9)**

cm. 20x 90x 90h

COMBINAZIONI

- Combinations / • Zusammenstellungen
- Combinaisons / • Combinación múltiple



⚡ 0,525 KW _____ **4.716,00**
230V~ _____ 65 / 0,46
50/60 Hz

PI100-98ET PENTOLA INDIRETTA ELETTRICA LT.100 Vasca Ø cm. 60x42h (inclusa 1
09110831 testata chiusura piano mod.TPA-9)

EN Electric indirect boiling pan 100 lts. Tank Ø cm. 60x42h (included 1 Head end filler strip mod.TPA-9) • **DE** Indirekter Elektro-Kochkessel lt. 100 Becken Ø cm. 60x42h (inbegriffen 1 Abschluss-Element mod.TPA-9) • **FR** Marmite indirecte électrique lt. 100 Cuve Ø cm. 60x42h (inclus 1 Elément de jonction top mod.TPA-9) • **ES MARMITA DE CALEFACCIÓN INDIRECTA 100 LT. CUBA Ø CM. 60X42H (INCLUIDA 1 CHAPA DE CIERRE PARA TOP MOD.TPA-9)**

cm. 80x 90x 90h



⚡ 16 kW _____ **9.805,00**
400V~3N _____ 107 / 1,07
50/60 Hz

PI100A-98ET PENTOLA INDIRETTA ELETTRICA LT.100 Vasca Ø cm. 60x42h - carico
0911A831 automatico intercapedine (inclusa 1 testata chiusura piano mod.TPA-9)

EN Electric indirect boiling pan 100 lts. Tank Ø cm. 60x42h - automatic water-charge of double jacket (included 1 Head end filler strip mod.TPA-9) • **DE** Indirekter Elektro-Kochkessel lt. 100 Becken Ø cm. 60x42h - automatische Wasserstandskontrolle im Zwischenmantel (inbegriffen 1 Abschluss-Element mod.TPA-9) • **FR** Marmite indirecte électrique lt. 100 Cuve Ø cm. 60x42h - remplissage automatique dans la double paroi (inclus 1 Elément de jonction top mod.TPA-9) • **ES MARMITA DE CALEFACCIÓN INDIRECTA 100 LT. CUBA Ø CM. 60X42H - CARGA AUTOMÁTICA DE LA CAMISA INTERCAMBIADOR (INCLUIDA 1 CHAPA DE CIERRE PARA TOP MOD.TPA-9)**

cm. 80x 90x 90h

⚡ 16 kW _____ **12.228,00**
400V~3N _____ 107 / 1,07
50/60 Hz

PENTOLE ELETTRICHE

MOD. COD.	DESCRIZIONE/DESCRIPTION/BEZEICHNUNG/DESCRIPTION/DESCRIPCIÓN DIMENSIONI/DIMENSIONS/ABMESSUNGEN/DIMENSIONS/DIMENSIONES	POTENZA/POWER/LEISTUNG/PUISSANCE/POTENCIA VOLTAGGIO/VOLTAGE/SPANNUNG/VOLTAGE/VOLTAJE	$\frac{\text{kW}}{\text{kcal/h}}$ $\frac{\text{V}\sim}{\text{Hz}}$	PREZZO/PRICE € PREIS/PRIX/PRECIO KG / M ³
---------------------	---	---	---	---

PIA100-98ET 09110833 **PENTOLA INDIRETTA ELETTRICA LT. 100 AUTOCLAVE - Vasca Ø cm. 60x42h (inclusa 1 testata chiusura piano mod.TPA-9)**
EN Electric indirect boiling pan 100 lts. autoclave Tank Ø cm. 60x42h (included 1 Head end filler strip mod.TPA-9) • **DE** Indirekter Elektro-Kochkessel 100 lt. Druckkessel Becken Ø cm. 60x42h (inbegriffen 1 Abschluss-Element mod.TPA-9) • **FR** Marmite indirecte électrique 100 lt. autoclave Cuve Ø cm. 60x42h (inclus 1 Élément de jonction top mod.TPA-9) • **ES MARMITA DE CALEFACCIÓN INDIRECTA 100 LT. AUTOCLAVE CUBA Ø CM. 60X42H (INCLUIDA 1 CHAPA DE CIERRE PARA TOP MOD.TPA-9)**
cm. 80x 90x 90h



$\frac{16 \text{ kW}}{400\text{V}\sim 3\text{N}}$ **11.553,00**
 $\frac{18.060 \text{ kcal/h}}{50/60 \text{ Hz}}$ 113 / 1,07

PIA100A-98ET 0911A833 **PENTOLA INDIRETTA ELETTRICA LT. 100 AUTOCLAVE - Vasca Ø cm. 60x42h - carico automatico intercapedine (inclusa 1 testata chiusura piano mod.TPA-9)**
EN Electric indirect boiling pan 100 lts. autoclave Tank Ø cm. 60x42h - automatic water-charge of double jacket (included 1 Head end filler strip mod.TPA-9) • **DE** Indirekter Elektro-Kochkessel 100 lt. Druckkessel Becken Ø cm. 60x42h - automatische Wasserstandskontrolle im Zwischenmantel (inbegriffen 1 Abschluss-Element mod.TPA-9) • **FR** Marmite indirecte électrique 100 lt. autoclave Cuve Ø cm. 60x42h - remplissage automatique dans la double paroi (inclus 1 Élément de jonction top mod.TPA-9) • **ES MARMITA DE CALEFACCIÓN INDIRECTA 100 LT. AUTOCLAVE CUBA Ø CM. 60X42H - CARGA AUTOMÁTICA DE LA CAMISA INTERCAMBIADOR (INCLUIDA 1 CHAPA DE CIERRE PARA TOP MOD.TPA-9)**
cm. 80x 90x 90h

$\frac{16 \text{ kW}}{400\text{V}\sim 3\text{N}}$ **13.975,00**
 $\frac{18.060 \text{ kcal/h}}{50/60 \text{ Hz}}$ 113 / 1,07

PD100-98G 09280850 **PENTOLA DIRETTA GAS LT.100 Vasca Ø cm. 60x42h (inclusa 1 testata chiusura piano mod.TPA-9)**
EN Gas direct boiling pan 100 lts. Tank Ø cm. 60x42h (included 1 Head end filler strip mod.TPA-9) • **DE** Direkter Gas-Kochkessel 100 lt. Becken Ø cm. 60x42h (inbegriffen 1 Abschluss-Element mod.TPA-9) • **FR** Marmite directe à gaz 100 lt. Cuve Ø cm. 60x42h (inclus 1 Élément de jonction top mod.TPA-9) • **ES MARMITA DE CALEFACCIÓN DIRECTA LT. 100 CUBA Ø CM. 60X42H (INCLUIDA 1 CHAPA DE CIERRE PARA TOP MOD.TPA-9)**
cm. 80x 90x 90h



$\frac{21 \text{ kW}}{18.060 \text{ kcal/h}}$ **7.672,00**
 $\frac{18.060 \text{ kcal/h}}{106 / 1,07}$

PDA100-98G 09280852 **PENTOLA DIRETTA GAS LT. 100 AUTOCLAVE Vasca Ø cm. 60x42h (inclusa 1 testata chiusura piano mod.TPA-9)**
EN Gas direct boiling pan 100 lts. autoclave Tank Ø cm. 60x42h (included 1 Head end filler strip mod.TPA-9) • **DE** Direkter Gas-Kochkessel 100 lt. Druckkessel Becken Ø cm. 60x42h (inbegriffen 1 Abschluss-Element mod.TPA-9) • **FR** Marmite directe à gaz 100 lt. autoclave Cuve Ø cm. 60x42h (inclus 1 Élément de jonction top mod.TPA-9) • **ES MARMITA DE CALEFACCIÓN DIRECTA LT. 100 AUTOCLAVE CUBA Ø CM. 60X42H (INCLUIDA 1 CHAPA DE CIERRE PARA TOP MOD.TPA-9)**
cm. 80x 90x 90h

$\frac{21 \text{ kW}}{18.060 \text{ kcal/h}}$ **9.426,00**
 $\frac{18.060 \text{ kcal/h}}{111 / 1,07}$

PI100-98G 09280851 **PENTOLA INDIRETTA GAS LT.100 Vasca Ø cm. 60x42h (inclusa 1 testata chiusura piano mod.TPA-9)**
EN Gas indirect boiling pan 100 lts. Tank Ø cm. 60x42h (included 1 Head end filler strip mod.TPA-9) • **DE** Indirekter Gas-Kochkessel 100 lt. Becken Ø cm. 60x42h (inbegriffen 1 Abschluss-Element mod.TPA-9) • **FR** Marmite indirecte à gaz 100 lt. Cuve Ø cm. 60x42h (inclus 1 Élément de jonction top mod.TPA-9) • **ES MARMITA DE CALEFACCIÓN INDIRECTA A GAS LT. 100 CUBA Ø CM. 60X42H (INCLUIDA 1 CHAPA DE CIERRE PARA TOP MOD.TPA-9)**
cm. 80x 90x 90h



$\frac{21 \text{ kW}}{18.060 \text{ kcal/h}}$ **10.023,00**
 $\frac{18.060 \text{ kcal/h}}{131 / 1,07}$

PENTOLE A GAS

MOD. _____ DESCRIZIONE/DESCRIPTION/BEZEICHNUNG/DESCRIPTION/DESCRIPCIÓN POTENZA/POWER/LEISTUNG/PUISSANCE/POTENCIA ⚡ kW ⚡ kw PREZZO/PRICE €
 COD. _____ DIMENSIONI/DIMENSIONS/ABMESSUNGEN/DIMENSIONS/DIMENSIONES VOLTAGGIO/VOLTAGE/SPANNUNG/VOLTAGE/VOLTAJE kcal/h kcal/h V~ Hz PREIS/PRIX/PRECIO €
 KG / M³

PI100A-98G PENTOLA INDIRECTA GAS LT.100 Vasca Ø cm. 60x42h - carico automatico intercapedine (inclusa 1 testata chiusura piano mod.TPA-9) 0928A851
EN Gas indirect boiling pan 100 lts. Tank Ø cm. 60x42h - automatic water-charge of double jacket (included 1 Head end filler strip mod. TPA-9) • **DE** Indirekter Gas-Kochkessel 100 lt. Becken Ø cm. 60x42h - automatische Wasserstandskontrolle im Zwischenmantel (inbegriffen 1 Abschluss-Element mod.TPA-9) • **FR** Marmite indirecte à gaz 100 lt. Cuve Ø cm. 60x42h - remplissage automatique dans la double paroi (inclus 1 Élément de jonction top mod.TPA-9) • **ES MARMITA DE CALEFACCIÓN INDIRECTA A GAS LT. 100 CUBA Ø CM. 60X42H - CARGA AUTOMÁTICA DE LA CAMISA INTERCAMBIADOR (INCLUIDA 1 CHAPA DE CIERRE PARA TOP MOD.TPA-9)**
cm. 80x 90x 90h



⚡ 21 kW **12.624,00**
 18.060 kcal/h 131 / 1,07
 ⚡ 0,1 KW
 230V~
 50/60 Hz

PIA100-98G PENTOLA INDIRECTA GAS LT. 100 AUTOCLAVE Vasca Ø cm. 60x42h 09280853
EN Gas indirect boiling pan 100 lts. - Autoclave Tank Ø cm. 60x42h (included 1 Head end filler strip mod.TPA-9) • **DE** Indirekter Gas-Kochkessel 100 lt. - Druckkessel Becken Ø cm. 60x42h (inbegriffen 1 Abschluss-Element mod.TPA-9) • **FR** Marmite indirecte gaz 100 lt. - Autoclave Cuve Ø cm. 60x42h (inclus 1 Élément de jonction top mod. TPA-9) • **ES MARMITA DE CALEFACCIÓN INDIRECTA 100 LT. - AUTOCLAVE CUBA Ø CM. 60X42H (INCLUIDA 1 CHAPA DE CIERRE PARA TOP MOD.TPA-9)**
cm. 80x 90x 90h

⚡ 21 kW **11.757,00**
 18.060 kcal/h 136 / 1,07

PIA100A-98G PENTOLA INDIRECTA GAS LT. 100 AUTOCLAVE Vasca Ø cm. 60x42h - 0928A853
 carico automatico intercapedine (inclusa 1 testata chiusura piano mod. TPA-9)
EN Gas indirect boiling pan 100 lts. - Autoclave Tank Ø cm. 60x42h - automatic water-charge of double jacket (included 1 Head end filler strip mod.TPA-9) • **DE** Indirekter Gas-Kochkessel 100 lt. - Druckkessel Becken Ø cm. 60x42h - automatische Wasserstandskontrolle im Zwischenmantel (inbegriffen 1 Abschluss-Element mod.TPA-9) • **FR** Marmite indirecte gaz 100 lt. - Autoclave Cuve Ø cm. 60x42h - remplissage automatique dans la double paroi (inclus 1 Élément de jonction top mod.TPA-9) • **ES MARMITA DE CALEFACCIÓN INDIRECTA 100 LT. - AUTOCLAVE CUBA Ø CM. 60X42H - CARGA AUTOMÁTICA DE LA CAMISA INTERCAMBIADOR (INCLUIDA 1 CHAPA DE CIERRE PARA TOP MOD.TPA-9)**
cm. 80x 90x 90h

⚡ 21 kW **14.356,00**
 18.060 kcal/h 136 / 1,07
 ⚡ 0,1 KW
 230V~
 50/60 Hz

531043401 OPTIONAL: Cesto 1/1 per pentola 100 LT
EN Optional: Basket 1/1 for boiling pan • **DE** Zubehör: Korb 1/1 für Kochkessel • **FR** En option: Panier 1/1 pour marmite • **ES OPCIONAL: CESTA 1/1 POR MARMITA**
cm. Ø 56x 34,5h

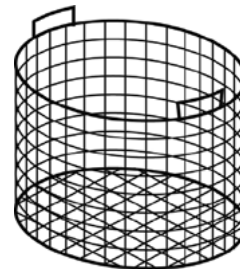

1.263,00
 5 / 0,18

531043501 OPTIONAL: Cesto 1/1 per pentola 150 LT
EN Optional: Basket 1/1 for boiling pan • **DE** Zubehör: Korb 1/1 für Kochkessel • **FR** En option: Panier 1/1 pour marmite • **ES OPCIONAL: CESTA 1/1 POR MARMITA**
cm. Ø 56x 47h

1.317,00
 5 / 0,22

531043601 OPTIONAL: Cesto 1/2 per pentola 100 LT
EN Optional: Basket 1/2 for boiling pan • **DE** Zubehör: Korb 1/2 für Kochkessel • **FR** En option: Panier 1/2 pour marmite • **ES OPCIONAL: CESTA 1/2 POR MARMITA**
cm. Ø 56x 34,5h

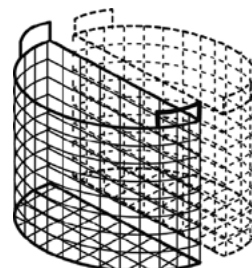

772,00
 2.5 / 0,11

531043701 OPTIONAL: Cesto 1/2 per pentola 150 LT
EN Optional: Basket 1/2 for boiling pan • **DE** Zubehör: Korb 1/2 für Kochkessel • **FR** En option: Panier 1/2 pour marmite • **ES OPCIONAL: CESTA 1/2 POR MARMITA**
cm. Ø 56x 47h

939,00
 2.5 / 0,13

ACCESSORI PENTOLE

MOD. _____ DESCRIZIONE/DESCRIPTION/BEZEICHNUNG/DESCRIPTION/DESCRIPCIÓN POTENZA/POWER/LEISTUNG/PUISSANCE/POTENCIA kW kw PREZZO/PRICE €
 COD. _____ DIMENSIONI/DIMENSIONS/ABMESSUNGEN/DIMENSIONS/DIMENSIONES VOLTAGGIO/VOLTAGE/SPANNUNG/VOLTAGE/VOLTAGE kcal/h V~ Hz PREIS/PRIX/PRECIO €
 KG / M³

ISP
 09580020 OPTIONAL: Imbuto per scarico pentole
EN Optional: Channel for pan drainage • **DE** Zubehör: Trichter zum Entleeren der Töpfe • **FR** En option: Entonnoir pour vidange marmites
 • **ES OPCIONAL: EMBUDO PARA DESCARGAR MARMITAS**

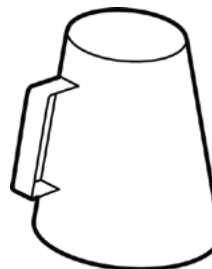

166,00
 5 / 0,04

PI150-98ET PENTOLA INDIRETTA ELETTRICA LT. 135 Vasca Ø cm. 60x54h (inclusa 1 testata chiusura piano mod.TPA-9)
 09110836 **EN** Electric indirect boiling pan 135 lts. Tank Ø cm. 60x54h (included 1 Head end filler strip mod.TPA-9) • **DE** Indirekter Elektro-Kochkessel 135 lt. Becken Ø cm. 60x54h (inbegriffen 1 Abschluss-Element mod. TPA-9) • **FR** Marmite indirecte électrique 135 lt. Cuve Ø cm. 60x54h (inclus 1 Élément de jonction top mod.TPA-9) • **ES MARMITA DE CALEFACCIÓN INDIRECTA 135 LT. CUBA Ø CM. 60X54H (INCLUIDA 1 CHAPA DE CIERRE PARA TOP MOD.TPA-9) cm. 80x 90x 90h**



⚡ 18 kW **10.198,00**
 400V~3N 110 / 1,07
 50/60 Hz

PI150A-98ET PENTOLA INDIRETTA ELETTRICA LT. 135 Vasca Ø cm. 60x54h - carico automatico intercapedine (inclusa 1 testata chiusura piano mod.TPA-9)
 0911A836 **EN** Electric indirect boiling pan 135 lts. Tank Ø cm. 60x54h - automatic water-charge of double jacket (included 1 Head end filler strip mod. TPA-9) • **DE** Indirekter Elektro-Kochkessel 135 lt. Becken Ø cm. 60x54h - automatische Wasserstandskontrolle im Zwischenmantel (inbegriffen 1 Abschluss-Element mod.TPA-9) • **FR** Marmite indirecte électrique 135 lt. Cuve Ø cm. 60x54h - remplissage automatique dans la double paroi (inclus 1 Élément de jonction top mod.TPA-9) • **ES MARMITA DE CALEFACCIÓN INDIRECTA 135 LT. CUBA Ø CM. 60X54H - CARGA AUTOMÁTICA DE LA CAMISA INTERCAMBIADOR (INCLUIDA 1 CHAPA DE CIERRE PARA TOP MOD.TPA-9) cm. 80x 90x 90h**

⚡ 18 kW **12.623,00**
 400V~3N 110 / 1,07
 50/60 Hz

PIA150-98ET PENTOLA INDIRETTA ELETTRICA LT. 135 AUTOCLAVE - Vasca cm. Ø 60x54h (inclusa 1 testata chiusura piano mod.TPA-9)
 09110837 **EN** Electric indirect boiling pan 135 lts. - Autoclave Tank Ø cm. 60x54h (included 1 Head end filler strip mod.TPA-9) • **DE** Indirekter Elektro-Kochkessel 135 lt. - Druckkessel Becken Ø cm. 60x54h (inbegriffen 1 Abschluss-Element mod.TPA-9) • **FR** Marmite indirecte électrique 135 lt. - Autoclave Cuve Ø cm. 60x54h (inclus 1 Élément de jonction top mod.TPA-9) • **ES MARMITA DE CALEFACCIÓN 135 LT. - AUTOCLAVE CUBA Ø CM. 60X54H (INCLUIDA 1 CHAPA DE CIERRE PARA TOP MOD.TPA-9) cm. 80x 90x 90h**

⚡ 18 kW **11.990,00**
 400V~3N 116 / 1,07
 50/60 Hz

PIA150A-98ET PENTOLA INDIRETTA ELETTRICA LT. 135 AUTOCLAVE - Vasca cm. Ø 60x54h - carico automatico intercapedine (inclusa 1 testata chiusura piano mod.TPA-9)
 0911A837 **EN** Electric indirect boiling pan 135 lts. - Autoclave Tank Ø cm. 60x54h - automatic water-charge of double jacket (included 1 Head end filler strip mod.TPA-9) • **DE** Indirekter Elektro-Kochkessel 135 lt. - Druckkessel Becken Ø cm. 60x54h - automatische Wasserstandskontrolle im Zwischenmantel (inbegriffen 1 Abschluss-Element mod.TPA-9) • **FR** Marmite indirecte électrique 135 lt. - Autoclave Cuve Ø cm. 60x54h - remplissage automatique dans la double paroi (inclus 1 Élément de jonction top mod.TPA-9) • **ES MARMITA DE CALEFACCIÓN 135 LT. - AUTOCLAVE CUBA Ø CM. 60X54H - CARGA AUTOMÁTICA DE LA CAMISA INTERCAMBIADOR (INCLUIDA 1 CHAPA DE CIERRE PARA TOP MOD.TPA-9) cm. 80x 90x 90h**

⚡ 18 kW **14.414,00**
 400V~3N 116 / 1,07
 50/60 Hz

PENTOLE A GAS

MOD. _____
COD. _____

DESCRIZIONE/DESCRIPTION/BEZEICHNUNG/DESCRIPTION/DESCRIPCIÓN
DIMENSIONI/DIMENSIONS/ABMESSUNGEN/DIMENSIONS/DIMENSIONES

POTENZA/POWER/LEISTUNG/PUISSANCE/POTENCIA
VOLTAGGIO/VOLTAGE/SPANNUNG/VOLTAGE/VOLTAJE

⚡ kW _____
kcal/h _____
V~ _____
Hz _____

PREZZO/PRICE €
PREIS/PRIX/PRECIO €
KG / M³

PD150-98G 09280854 PENTOLA DIRETTA GAS LT. 140 Vasca Ø cm. 60x54h (inclusa 1 testata chiusura piano mod.TPA-9)
EN Gas direct boiling pan 140 lts. Tank Ø cm. 60x54h (included 1 Head end filler strip mod.TPA-9) • **DE** Direkter Gas-Kochkessel 140 lt. Becken Ø cm. 60x54h (inbegriffen 1 Abschluss-Element mod.TPA-9) • **FR** Marmite directe à gaz 140 lt. Cuve Ø cm. 60x54h (inclus 1 Élément de jonction top mod.TPA-9) • **ES MARMITA DE CALEFACCIÓN DIRECTA LT. 140 CUBA Ø CM. 60X54H (INCLUIDA 1 CHAPA DE CIERRE PARA TOP MOD.TPA-9)**
cm. 80x 90x 90h



⚡ 21 kW _____ **7.859,00**
18.060 kcal/h _____ 108 / 1,07

PDA150-98G 09280855 PENTOLA DIRETTA GAS LT. 140 AUTOCLAVE Vasca Ø cm. 60x54h (inclusa 1 testata chiusura piano mod.TPA-9)
EN Gas direct boiling pan 140 lts. - Autoclave Tank Ø cm. 60x54h (included 1 Head end filler strip mod.TPA-9) • **DE** Direkter Gas-Kochkessel 140 lt. - Druckkessel Becken Ø cm. 60x54h (inbegriffen 1 Abschluss-Element mod.TPA-9) • **FR** Marmite directe à gaz 140 lt. - Autoclave Cuve Ø cm. 60x54h (inclus 1 Élément de jonction top mod.TPA-9) • **ES MARMITA DE CALEFACCIÓN DIRECTA LT. 140 - AUTOCLAVE CUBA Ø CM. 60X54H (INCLUIDA 1 CHAPA DE CIERRE PARA TOP MOD.TPA-9)**
cm. 80x 90x 90h

⚡ 21 kW _____ **9.633,00**
18.060 kcal/h _____ 113 / 1,07

PI150-98G 09280856 PENTOLA INDIRETTA GAS LT. 135 Vasca Ø cm. 60x54h (inclusa 1 testata chiusura piano mod.TPA-9)
EN Gas indirect boiling pan 135 lts. Tank Ø cm. 60x54h (included 1 Head end filler strip mod.TPA-9) • **DE** Indirekter Gas-Kochkessel 135 lt. Becken Ø cm. 60x54h (inbegriffen 1 Abschluss-Element mod.TPA-9) • **FR** Marmite indirecte à gaz 135 lt. Cuve Ø cm. 60x54h (inclus 1 Élément de jonction top mod.TPA-9) • **ES MARMITA DE CALEFACCIÓN INDIRECTA LT. 135 CUBA Ø CM. 60X54H (INCLUIDA 1 CHAPA DE CIERRE PARA TOP MOD.TPA-9)**
cm. 80x 90x 90h



⚡ 21 kW _____ **10.377,00**
18.060 kcal/h _____ 135 / 1,07

PI150A-98G 0928A856 PENTOLA INDIRETTA GAS LT. 135 Vasca Ø cm. 60x54h - carico automatico intercapedine (inclusa 1 testata chiusura piano mod.TPA-9)
EN Gas indirect boiling pan 135 lts. Tank Ø cm. 60x54h - automatic water-charge of double jacket (included 1 Head end filler strip mod.TPA-9) • **DE** Indirekter Gas-Kochkessel 135 lt. Becken Ø cm. 60x54h - automatische Wasserstandskontrolle im Zwischenmantel (inbegriffen 1 Abschluss-Element mod.TPA-9) • **FR** Marmite indirecte à gaz 135 lt. Cuve Ø cm. 60x54h - remplissage automatique dans la double paroi (inclus 1 Élément de jonction top mod.TPA-9) • **ES MARMITA DE CALEFACCIÓN INDIRECTA LT. 135 CUBA Ø CM. 60X54H - CARGA AUTOMÁTICA DE LA CAMISA INTERCAMBIADOR (INCLUIDA 1 CHAPA DE CIERRE PARA TOP MOD.TPA-9)**
cm. 80x 90x 90h

⚡ 21 kW _____ **12.974,00**
18.060 kcal/h _____ 135 / 1,07

⚡ 0,1 KW _____
230V~ _____
50/60 Hz _____

PIA150-98G 09280857 PENTOLA INDIRETTA GAS LT. 135 AUTOCLAVE Vasca Ø cm. 60x54h (inclusa 1 testata chiusura piano mod.TPA-9)
EN Gas indirect boiling pan 135 lts. - Autoclave Tank Ø cm. 60x54h (included 1 Head end filler strip mod.TPA-9) • **DE** Indirekter Gas-Kochkessel 135 lt. - Druckkessel Becken Ø cm. 60x54h (inbegriffen 1 Abschluss-Element mod.TPA-9) • **FR** Marmite indirecte électrique à gaz 135 lt. - Autoclave Cuve Ø cm. 60x54h (inclus 1 Élément de jonction top mod.TPA-9) • **ES MARMITA DE CALEFACCIÓN INDIRECTA A GAS 135 LT. - AUTOCLAVE CUBA Ø CM. 60X54H (INCLUIDA 1 CHAPA DE CIERRE PARA TOP MOD.TPA-9)**
cm. 80x 90x 90h

⚡ 21 kW _____ **12.148,00**
18.060 kcal/h _____ 115 / 1,07

PIA150A-98G 0928A857 PENTOLA INDIRETTA GAS LT. 135 AUTOCLAVE Vasca Ø cm. 60x54h - carico automatico intercapedine (inclusa 1 testata chiusura piano mod.TPA-9)
EN Gas indirect boiling pan 135 lts. - Autoclave Tank Ø cm. 60x54h - automatic water-charge of double jacket (included 1 Head end filler strip mod.TPA-9) • **DE** Indirekter Gas-Kochkessel 135 lt. - Druckkessel Becken Ø cm. 60x54h - automatische Wasserstandskontrolle im Zwischenmantel (inbegriffen 1 Abschluss-Element mod.TPA-9) • **FR** Marmite indirecte électrique à gaz 135 lt. - Autoclave Cuve Ø cm. 60x54h - remplissage automatique dans la double paroi (inclus 1 Élément de jonction top mod.TPA-9) • **ES MARMITA DE CALEFACCIÓN INDIRECTA A GAS 135 LT. - AUTOCLAVE CUBA Ø CM. 60X54H - CARGA AUTOMÁTICA DE LA CAMISA INTERCAMBIADOR (INCLUIDA 1 CHAPA DE CIERRE PARA TOP MOD.TPA-9)**
cm. 80x 90x 90h

⚡ 21 kW _____ **14.748,00**
18.060 kcal/h _____ 115 / 1,07

⚡ 0,1 KW _____
230V~ _____
50/60 Hz _____

FRY-TOP ELETTRICI

MOD. / COD. DESCRIZIONE / DESCRIPTION / BEZEICHNUNG / DESCRIPTION / DESCRIPCIÓN DIMENSIONI / DIMENSIONS / ABMESSUNGEN / DIMENSIONS / DIMENSIONES POTENZA / POWER / LEISTUNG / PUISSANCE / POTENCIA VOLTAGGIO / VOLTAGE / SPANNUNG / VOLTAGE / VOLTAJE $\frac{kW}{kcal/h}$ $\frac{kW}{V \sim}$ Hz PREZZO / PRICE € PREIS / PRIX / PRECIO KG / M³

FTL-94ET
09060431 Fry-top elettrico liscio, su mobile a giorno, piastra cm.36x68 (inclusa 1 testata chiusura piano mod.TPA-9)
EN Electric Fry-top smooth griddle, on open cabinet, plate cm.36x68 (included 1 Head end filler strip mod.TPA-9) • **DE** Griddleplatte elektrische glatt, mit offenem Unterbau, platte cm.36x68 (inbegriffen 1 Abschluss-Element mod.TPA-9) • **FR** Plaque électriques lisse, sur armoire ouvert, plaque cm.36x68 (inclus 1 Élément de jonction top mod.TPA-9) • **ES FRY-TOP ELÉCTRICO LISO, SOBRE MUEBLE ABIERTO, PLANCHA CM.36X68 (INCLUIDA 1 CHAPA DE CIERRE PARA TOP MOD.TPA-9)**
cm. 40x 90x 90h



$\frac{7,5 kW}{400V \sim 3N}$ **2.786,00**
50/60 Hz 79 / 0,46

FTL-94ETS
09060434 Fry-top elettrico liscio cromato SUPERCHROME (Moca Approved), su mobile a giorno, piastra cm.36x68 (inclusa 1 testata chiusura piano mod.TPA-9)
EN Electric Fry-top smooth chromed griddle SUPERCHROME (Moca Approved), on open cabinet, plate cm.36x68 (included 1 Head end filler strip mod.TPA-9) • **DE** Griddleplatte elektrische glatt hartverchromt SUPERCHROME (Moca Approved), mit offenem Unterbau, platte cm.36x68 (inbegriffen 1 Abschluss-Element mod.TPA-9) • **FR** Plaque électriques lisse chromée SUPERCHROME (Moca Approved), sur armoire ouvert, plaque cm.36x68 (inclus 1 Élément de jonction top mod.TPA-9) • **ES FRY-TOP ELÉCTRICO LISO CROMADO SUPERCHROME (MOCA APPROVED), SOBRE MUEBLE ABIERTO, PLANCHA CM.36X68 (INCLUIDA 1 CHAPA DE CIERRE PARA TOP MOD.TPA-9)**
cm. 40x 90x 90h

$\frac{7,5 kW}{400V \sim 3N}$ **3.303,00**
50/60 Hz 79 / 0,46

FTL-94ETS
09060430 Fry-top elettrico liscio CROMO LUCIDO, su mobile a giorno, piastra cm.36x68 (inclusa 1 testata chiusura piano mod.TPA-9)
EN Electric Fry-top smooth POLISHED CHROME, on open cabinet, plate cm.36x68 (included 1 Head end filler strip mod.TPA-9) • **DE** Griddleplatte elektrische glatt POLIERTEM CHROM, mit offenem Unterbau, platte cm.36x68 (inbegriffen 1 Abschluss-Element mod.TPA-9) • **FR** Plaque électriques lisse CHROME POLI, sur armoire ouvert, plaque cm.36x68 (inclus 1 Élément de jonction top mod.TPA-9) • **ES FRY-TOP ELÉCTRICO LISO CROMO PULIDO, SOBRE MUEBLE ABIERTO, PLANCHA CM.36X68 (INCLUIDA 1 CHAPA DE CIERRE PARA TOP MOD.TPA-9)**
cm. 40x 90x 90h

$\frac{7,5 kW}{400V \sim 3N}$ **3.303,00**
50/60 Hz 79 / 0,46

FTR-94ET
09060433 Fry-top elettrico rigato, su mobile a giorno, piastra cm.36x68 (inclusa 1 testata chiusura piano mod.TPA-9)
EN Electric Fry-top grooved griddle, on open cabinet, plate cm.36x68 (included 1 Head end filler strip mod.TPA-9) • **DE** Griddleplatte elektrische gerillt, mit offenem Unterbau, platte cm.36x68 (inbegriffen 1 Abschluss-Element mod.TPA-9) • **FR** Plaque électriques nervurée, sur armoire ouvert, plaque cm.36x68 (inclus 1 Élément de jonction top mod.TPA-9) • **ES FRY-TOP ELÉCTRICO ESTRIADO, SOBRE MUEBLE ABIERTO, PLANCHA CM.36X68 (INCLUIDA 1 CHAPA DE CIERRE PARA TOP MOD.TPA-9)**
cm. 40x 90x 90h



$\frac{7,5 kW}{400V \sim 3N}$ **2.983,00**
50/60 Hz 79 / 0,46

FTR-94ETS
09060436 Fry-top elettrico rigato cromato SUPERCHROME (Moca Approved), su mobile a giorno, piastra cm.36x68 (inclusa 1 testata chiusura piano mod.TPA-9)
EN Electric Fry-top grooved chromed griddle SUPERCHROME (Moca Approved), on open cabinet, plate cm.36x68 (included 1 Head end filler strip mod.TPA-9) • **DE** Griddleplatte elektrische gerillt hartverchromt SUPERCHROME (Moca Approved), mit offenem Unterbau, platte cm.36x68 (inbegriffen 1 Abschluss-Element mod.TPA-9) • **FR** Plaque électriques nervurée chromée SUPERCHROME (Moca Approved), sur armoire ouvert, plaque cm.36x68 (inclus 1 Élément de jonction top mod.TPA-9) • **ES FRY-TOP ELÉCTRICO ESTRIADO CROMADO SUPERCHROME (MOCA APPROVED), SOBRE MUEBLE ABIERTO, PLANCHA CM.36X68 (INCLUIDA 1 CHAPA DE CIERRE PARA TOP MOD.TPA-9)**
cm. 40x 90x 90h

$\frac{7,5 kW}{400V \sim 3N}$ **3.496,00**
50/60 Hz 79 / 0,46

FRY-TOP ELETTRICI

MOD. _____
COD. _____

DESCRIZIONE/DESCRIPTION/BEZEICHNUNG/DESCRIPTION/DESCRIPCIÓN
DIMENSIONI/DIMENSIONS/ABMESSUNGEN/DIMENSIONS/DIMENSIONES

POTENZA/POWER/LEISTUNG/PUISSANCE/POTENCIA
VOLTAGGIO/VOLTAGE/SPANNUNG/VOLTAGE/VOLTAJE

⚡ kW
kcal/h

PREZZO/PRICE
PREIS/PRIX/PRECIO €
KG / M³

FTL-98ET
09060831

Fry-top elettrico liscio, su mobile a giorno, piastra cm.76x68 - 2 zone di cottura (inclusa 1 testata chiusura piano mod.TPA-9)
EN Electric Fry-top smooth griddle, on open cabinet, plate cm.76x68 - 2 cooking areas (included 1 Head end filler strip mod.TPA-9) • **DE** Griddleplatte elektrische glatt, mit offenem Unterbau, platte cm.76x68 - 2 Heizzonen (inbegriffen 1 Abschluss-Element mod.TPA-9) • **FR** Plaque électriques lisse, sur armoire ouvert, plaque cm.76x68 - 2 zones de cuisson (inclus 1 Élément de jonction top mod.TPA-9) • **ES FRY-TOP ELÉCTRICO LISO, SOBRE MUEBLE ABIERTO, PLANCHA CM.76X68 - 2 ZONAS DE COCCIÓN (INCLUIDA 1 CHAPA DE CIERRE PARA TOP MOD.TPA-9)**
cm. 80x 90x 90h



⚡ 15 kW **4.054,00**
400V~3N 126 / 0,89
50/60 Hz

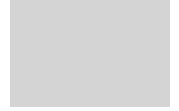

FTL-98ETS
09060834

Fry-top elettrico liscio cromato SUPERCHROME (Moca Approved), su mobile a giorno, piastra cm.76x68 - 2 zone di cottura (inclusa 1 testata chiusura piano mod.TPA-9)
EN Electric Fry-top smooth chromed griddle SUPERCHROME (Moca Approved), on open cabinet, plate cm.76x68 - 2 cooking areas (included 1 Head end filler strip mod.TPA-9) • **DE** Griddleplatte elektrische glatt hartverchromt SUPERCHROME (Moca Approved), mit offenem Unterbau, platte cm.76x68 - 2 Heizzonen (inbegriffen 1 Abschluss-Element mod.TPA-9) • **FR** Plaque électriques lisse chromée SUPERCHROME (Moca Approved), sur armoire ouvert, plaque cm.76x68 - 2 zones de cuisson (inclus 1 Élément de jonction top mod.TPA-9) • **ES FRY-TOP ELÉCTRICO LISO CROMADO SUPERCHROME (MOCA APPROVED), SOBRE MUEBLE ABIERTO, PLANCHA CM.76X68 - 2 ZONAS DE COCCIÓN (INCLUIDA 1 CHAPA DE CIERRE PARA TOP MOD.TPA-9)**
cm. 80x 90x 90h

⚡ 15 kW **4.824,00**
400V~3N 126 / 0,89
50/60 Hz

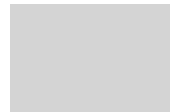

FTL-98ETSS
09060830

Fry-top elettrico liscio CROMO LUCIDO, su mobile a giorno, piastra cm.76x68 - 2 zone di cottura (inclusa 1 testata chiusura piano mod.TPA-9)
EN Electric Fry-top smooth POLISHED CHROME, on open cabinet, plate cm.76x68 - 2 cooking areas (included 1 Head end filler strip mod.TPA-9) • **DE** Griddleplatte elektrische glatt POLIERTEM CHROM, mit offenem Unterbau, platte cm.76x68 - 2 Heizzonen (inbegriffen 1 Abschluss-Element mod.TPA-9) • **FR** Plaque électriques lisse CHROME POLI, sur armoire ouvert, plaque cm.76x68 - 2 zones de cuisson (inclus 1 Élément de jonction top mod.TPA-9) • **ES FRY-TOP ELÉCTRICO LISO CROMO PULIDO, SOBRE MUEBLE ABIERTO, PLANCHA CM.76X68 - 2 ZONAS DE COCCIÓN (INCLUIDA 1 CHAPA DE CIERRE PARA TOP MOD.TPA-9)**
cm. 80x 90x 90h

⚡ 15 kW **4.824,00**
400V~3N 126 / 0,89
50/60 Hz



FTLR-98ET
09060832

Fry-top elettrico 1/2 rigato + 1/2 liscio, su mobile a giorno, piastra cm.76x68 - 2 zone di cottura (inclusa 1 testata chiusura piano mod.TPA-9)
EN Electric Fry-top 1/2 grooved + 1/2 smooth, on open cabinet, plate cm.76x68 - 2 cooking areas (included 1 Head end filler strip mod.TPA-9) • **DE** Griddleplatte elektrische 1/2 gerillt + 1/2 glatt, mit offenem Unterbau, platte cm.76x68 - 2 Heizzonen (inbegriffen 1 Abschluss-Element mod.TPA-9) • **FR** Plaque électriques 1/2 nervurée + 1/2 lisse, sur armoire ouvert, plaque cm.76x68 - 2 zones de cuisson (inclus 1 Élément de jonction top mod.TPA-9) • **ES FRY-TOP ELÉCTRICO 1/2 ESTRIADO + 1/2 LISO, SOBRE MUEBLE ABIERTO, PLANCHA CM.76X68 - 2 ZONAS DE COCCIÓN (INCLUIDA 1 CHAPA DE CIERRE PARA TOP MOD.TPA-9)**
cm. 80x 90x 90h



⚡ 15 kW **4.291,00**
400V~3N 126 / 0,89
50/60 Hz



FRY-TOP ELETTRICI

MOD. _____
COD. _____

DESCRIZIONE/DESCRIPTION/BEZEICHNUNG/DESCRIPTION/DESCRIPCIÓN
DIMENSIONI/DIMENSIONS/ABMESSUNGEN/DIMENSIONS/DIMENSIONES

POTENZA/POWER/LEISTUNG/PUISSANCE/POTENCIA
VOLTAGGIO/VOLTAGE/SPANNUNG/VOLTAGE/VOLTAJE

⚡ kW
kcal/h

⚡ kw
V~
Hz

PREZZO/PRICE €
PREIS/PRIX/PRECIO €
KG / M³

FTLR-98ETS Fry-top elettrico 1/2 rigato + 1/2 liscio cromato SUPERCHROME (Moca Approved), su mobile a giorno, piastra cm.76x68 - 2 zone di cottura (inclusa 1 testata chiusura piano mod.TPA-9)
EN Electric Fry-top 1/2 grooved + 1/2 smooth chromed griddle SUPERCHROME (Moca Approved), on open cabinet, plate cm.76x68 - 2 cooking areas (included 1 Head end filler strip mod.TPA-9)
• **DE** Griddleplatte elektrische 1/2 gerillt + 1/2 glatt hartverchromt SUPERCHROME (Moca Approved), mit offenem Unterbau, platte cm.76x68 - 2 Heizzonen (inbegriffen 1 Abschluss-Element mod.TPA-9) • **FR** Plaque électriques 1/2 nervurée + 1/2 lisse chromée SUPERCHROME (Moca Approved), sur armoire ouvert, plaque cm.76x68 - 2 zones de cuisson (inclus 1 Élément de jonction top mod.TPA-9) • **ES FRY-TOP ELÉCTRICO 1/2 ESTRIADO + 1/2 LISO CROMADO SUPERCHROME (MOCA APPROVED), SOBRE MUEBLE ABIERTO, PLANCHA CM.76X68 - 2 ZONAS DE COCCIÓN (INCLUIDA 1 CHAPA DE CIERRE PARA TOP MOD.TPA-9)**
cm. 80x 90x 90h



⚡ 15 kW
400V~3N
50/60 Hz

5.055,00
126 / 0,89



FTR-98ET Fry-top elettrico rigato, su mobile a giorno, piastra cm.76x68 - 2 zone di cottura (inclusa 1 testata chiusura piano mod.TPA-9)
EN Electric Fry-top grooved griddle, on open cabinet, plate cm.76x68 - 2 cooking areas (included 1 Head end filler strip mod.TPA-9) • **DE** Griddleplatte elektrische gerillt, mit offenem Unterbau, platte cm.76x68 - 2 Heizzonen (inbegriffen 1 Abschluss-Element mod.TPA-9) • **FR** Plaque électriques nervurée, sur armoire ouvert, plaque cm.76x68 - 2 zones de cuisson (inclus 1 Élément de jonction top mod.TPA-9) • **ES FRY-TOP ELÉCTRICO ESTRIADO, SOBRE MUEBLE ABIERTO, PLANCHA CM.76X68 - 2 ZONAS DE COCCIÓN (INCLUIDA 1 CHAPA DE CIERRE PARA TOP MOD.TPA-9)**
cm. 80x 90x 90h



⚡ 15 kW
400V~3N
50/60 Hz

4.526,00
126 / 0,89



FTR-98ETS Fry-top elettrico rigato cromato SUPERCHROME (Moca Approved), su mobile a giorno, piastra cm.76x68 - 2 zone di cottura (inclusa 1 testata chiusura piano mod.TPA-9)
EN Electric Fry-top grooved chromed griddle SUPERCHROME (Moca Approved), on open cabinet, plate cm.76x68 - 2 cooking areas (included 1 Head end filler strip mod.TPA-9) • **DE** Griddleplatte elektrische gerillt hartverchromt SUPERCHROME (Moca Approved), mit offenem Unterbau, platte cm.76x68 - 2 Heizzonen (inbegriffen 1 Abschluss-Element mod.TPA-9) • **FR** Plaque électriques nervurée chromée SUPERCHROME (Moca Approved), sur armoire ouvert, plaque cm.76x68 - 2 zones de cuisson (inclus 1 Élément de jonction top mod.TPA-9) • **ES FRY-TOP ELÉCTRICO ESTRIADO CROMADO SUPERCHROME (MOCA APPROVED), SOBRE MUEBLE ABIERTO, PLANCHA CM.76X68 - 2 ZONAS DE COCCIÓN (INCLUIDA 1 CHAPA DE CIERRE PARA TOP MOD.TPA-9)**
cm. 80x 90x 90h

⚡ 15 kW
400V~3N
50/60 Hz

5.291,00
126 / 0,89



FTL-912ET Fry-top elettrico liscio, su mobile a giorno, piastra cm.110,5x65 - 3 zone di cottura (inclusa 1 testata chiusura piano mod.TPA-9)
EN Electric Fry-top smooth griddle, on open cabinet, plate cm.110,5x65 - 3 cooking areas (included 1 Head end filler strip mod.TPA-9) • **DE** Griddleplatte elektrische glatt, mit offenem Unterbau, platte cm.110,5x65 - 3 Heizzonen (inbegriffen 1 Abschluss-Element mod.TPA-9) • **FR** Plaque électriques lisse, sur armoire ouvert, plaque cm.110,5x65 - 3 zones de cuisson (inclus 1 Élément de jonction top mod.TPA-9) • **ES FRY-TOP ELÉCTRICO LISO, SOBRE MUEBLE ABIERTO, PLANCHA CM.110,5X65 - 3 ZONAS DE COCCIÓN (INCLUIDA 1 CHAPA DE CIERRE PARA TOP MOD.TPA-9)**
cm. 120x 90x 90h



⚡ 22,5 kW
400V~3N
50/60 Hz

6.121,00
186 / 1,32



FRY-TOP ELETTRICI

MOD. _____
COD. _____

DESCRIZIONE/DESCRIPTION/BEZEICHNUNG/DESCRIPTION/DESCRIPCIÓN
DIMENSIONI/DIMENSIONS/ABMESSUNGEN/DIMENSIONS/DIMENSIONES

POTENZA/POWER/LEISTUNG/PUISSANCE/POTENCIA
VOLTAGGIO/VOLTAGE/SPANNUNG/VOLTAGE/VOLTAJE

⚡ kW _____
kcal/h _____
V~ _____
Hz _____

PREZZO/PRICE
PREIS/PRIX/PRECIO €
KG / M³

FTL-912ETS Fry-top elettrico liscio cromato SUPERCHROME (Moca Approved), su mobile a giorno, piastra cm.110,5x65 - 3 zone di cottura (inclusa 1 testata chiusura piano mod.TPA-9)
0906123E

EN Electric Fry-top smooth chromed griddle SUPERCHROME (Moca Approved), on open cabinet, plate cm.110,5x65 - 3 cooking areas (included 1 Head end filler strip mod.TPA-9) • **DE** Griddleplatte elektrische glatt hartverchromt SUPERCHROME (Moca Approved), mit offenem Unterbau, platte cm.110,5x65 - 3 Heizzonen (inbegriffen 1 Abschluss-Element mod.TPA-9) • **FR** Plaque électriques lisse chromée SUPERCHROME (Moca Approved), sur armoire ouvert, plaque cm.110,5x65 - 3 zones de cuisson (inclus 1 Élément de jonction top mod.TPA-9) • **ES FRY-TOP ELÉCTRICO LISO CROMADO SUPERCHROME (MOCA APPROVED), SOBRE MUEBLE ABIERTO, PLANCHA CM.110,5X65 - 3 ZONAS DE COCCIÓN (INCLUIDA 1 CHAPA DE CIERRE PARA TOP MOD.TPA-9)**
cm. 120x 90x 90h



⚡ 22,5 kW _____ **7.049,00**
400V~3N _____ 186 / 1,32
50/60 Hz

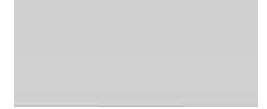

FTLR-912ET Fry-top elettrico 1/3 rigato + 2/3 liscio, su mobile a giorno, piastra cm.110,5x65 - 3 zone di cottura (inclusa 1 testata chiusura piano mod.TPA-9)
0906123C

EN Electric Fry-top 1/3 grooved + 2/3 smooth, on open cabinet, plate cm.110,5x65 - 3 cooking areas (included 1 Head end filler strip mod.TPA-9) • **DE** Griddleplatte elektrische 1/3 gerillt + 2/3 glatt, mit offenem Unterbau, platte cm.110,5x65 - 3 Heizzonen (inbegriffen 1 Abschluss-Element mod.TPA-9) • **FR** Plaque électriques 1/3 nervurée + 2/3 lisse, sur armoire ouvert, plaque cm.110,5x65 - 3 zones de cuisson (inclus 1 Élément de jonction top mod.TPA-9) • **ES FRY-TOP ELÉCTRICO 1/3 ESTRIADO + 2/3 LISO, SOBRE MUEBLE ABIERTO, PLANCHA CM.110,5X65 - 3 ZONAS DE COCCIÓN (INCLUIDA 1 CHAPA DE CIERRE PARA TOP MOD.TPA-9)**
cm. 120x 90x 90h



⚡ 22,5 kW _____ **6.515,00**
400V~3N _____ 186 / 1,32
50/60 Hz



FTLR-912ETS Fry-top elettrico 1/3 rigato + 2/3 liscio cromato SUPERCHROME (Moca Approved), su mobile a giorno, piastra cm.110,5x65 - 3 zone di cottura (inclusa 1 testata chiusura piano mod.TPA-9)
0906123F

EN Electric Fry-top 1/3 grooved + 2/3 smooth chromed griddle SUPERCHROME (Moca Approved), on open cabinet, plate cm.110,5x65 - 3 cooking areas (included 1 Head end filler strip mod.TPA-9) • **DE** Griddleplatte elektrische 1/3 gerillt + 2/3 glatt hartverchromt SUPERCHROME (Moca Approved), mit offenem Unterbau, platte cm.110,5x65 - 3 Heizzonen (inbegriffen 1 Abschluss-Element mod.TPA-9) • **FR** Plaque électriques 1/3 nervurée + 2/3 lisse chromée SUPERCHROME (Moca Approved), sur armoire ouvert, plaque cm.110,5x65 - 3 zones de cuisson (inclus 1 Élément de jonction top mod.TPA-9) • **ES FRY-TOP ELÉCTRICO 1/3 ESTRIADO + 2/3 LISO CROMADO SUPERCHROME (MOCA APPROVED), SOBRE MUEBLE ABIERTO, PLANCHA CM.110,5X65 - 3 ZONAS DE COCCIÓN (INCLUIDA 1 CHAPA DE CIERRE PARA TOP MOD.TPA-9)**
cm. 120x 90x 90h

⚡ 22,5 kW _____ **7.439,00**
400V~3N _____ 186 / 1,32
50/60 Hz



FTL-916ET Fry-top elettrico liscio, su mobile a giorno, piastra cm.150,5x65 - 4 zone di cottura (inclusa 1 testata chiusura piano mod.TPA-9)
09061631

EN Electric Fry-top smooth griddle, on open cabinet, plate cm.150,5x65 - 4 cooking areas (included 1 Head end filler strip mod.TPA-9) • **DE** Griddleplatte elektrische glatt, mit offenem Unterbau, platte cm.150,5x65 - 4 Heizzonen (inbegriffen 1 Abschluss-Element mod.TPA-9) • **FR** Plaque électriques lisse, sur armoire ouvert, plaque cm.150,5x65 - 4 zones de cuisson (inclus 1 Élément de jonction top mod.TPA-9) • **ES FRY-TOP ELÉCTRICO LISO, SOBRE MUEBLE ABIERTO, PLANCHA CM.150,5X65 - 4 ZONAS DE COCCIÓN (INCLUIDA 1 CHAPA DE CIERRE PARA TOP MOD.TPA-9)**
cm. 160x 90x 90h



⚡ 30 kW _____ **8.258,00**
400V~3N _____ 256 / 1,76
50/60 Hz



FRY-TOP ELETTRICI

MOD. _____ DESCRIZIONE/DESCRIPTION/BEZEICHNUNG/DESCRIPTION/DESCRIPCIÓN POTENZA/POWER/LEISTUNG/PUISSANCE/POTENCIA ⚡ kW ⚡ kW PREZZO/PRICE €
 COD. _____ DIMENSIONI/DIMENSIONS/ABMESSUNGEN/DIMENSIONS/DIMENSIONES VOLTAGGIO/VOLTAGE/SPANNUNG/VOLTAGE/VOLTAJE kcal/h V~ Hz PREIS/PRIX/PRECIO €
 KG / M³

FTL-916ETS Fry-top elettrico liscio cromato SUPERCHROME (Moca Approved), su mobile a giorno, piastra cm.150,5x65 - 4 zone di cottura (inclusa 1 testata chiusura piano mod.TPA-9)
 09061634 **EN** Electric Fry-top smooth chromed griddle SUPERCHROME (Moca Approved), on open cabinet, plate cm.150,5x65 - 4 cooking areas (included 1 Head end filler strip mod.TPA-9) • **DE** Griddleplatte elektrische glatt hartverchromt SUPERCHROME (Moca Approved), mit offenem Unterbau, platte cm.150,5x65 - 4 Heizzonen (inbegriffen 1 Abschluss-Element mod.TPA-9) • **FR** Plaque électriques lisse chromée SUPERCHROME (Moca Approved), sur armoire ouvert, plaque cm.150,5x65 - 4 zones de cuisson (inclus 1 Élément de jonction top mod.TPA-9) • **ES FRY-TOP ELÉCTRICO LISO CROMADO SUPERCHROME (MOCA APPROVED), SOBRE MUEBLE ABIERTO, PLANCHA CM.150,5X65 - 4 ZONAS DE COCCIÓN (INCLUIDA 1 CHAPA DE CIERRE PARA TOP MOD.TPA-9)**
cm. 160x 90x 90h



⚡ 30 kW **9.419,00**
 400V~3N 256 / 1,76
 50/60 Hz



FTL-94G Fry-top gas liscio, su mobile a giorno, piastra cm.36x68 (inclusa 1 testata chiusura piano mod.TPA-9)
 09230451 **EN** Gas Fry-top smooth griddle, on open cabinet, plate cm.36x68 (included 1 Head end filler strip mod.TPA-9) • **DE** Gas-griddleplatte glatt, mit offenem Unterbau, platte cm.36x68 (inbegriffen 1 Abschluss-Element mod.TPA-9) • **FR** Plaque gaz lisse, sur armoire ouvert, plaque cm.36x68 (inclus 1 Élément de jonction top mod.TPA-9) • **ES FRY-TOP GAS LISO, SOBRE MUEBLE ABIERTO, PLANCHA CM.36X68 (INCLUIDA 1 CHAPA DE CIERRE PARA TOP MOD.TPA-9)**
cm. 40x 90x 90h



⚡ 9 kW **2.743,00**
 7.740 kcal/h 81 / 0,46



FTL-94GS Fry-top gas liscio cromato SUPERCHROME (Moca Approved), su mobile a giorno, piastra cm.36x68 (inclusa 1 testata chiusura piano mod.TPA-9)
 09230454 **EN** Gas Fry-top smooth chromed griddle SUPERCHROME (Moca Approved), on open cabinet, plate cm.36x68 (included 1 Head end filler strip mod.TPA-9) • **DE** Gas-griddleplatte glatt hartverchromt SUPERCHROME (Moca Approved), mit offenem Unterbau, platte cm.36x68 (inbegriffen 1 Abschluss-Element mod.TPA-9) • **FR** Plaque gaz lisse chromée SUPERCHROME (Moca Approved), sur armoire ouvert, plaque cm.36x68 (inclus 1 Élément de jonction top mod.TPA-9) • **ES FRY-TOP GAS LISO CROMADO SUPERCHROME (MOCA APPROVED), SOBRE MUEBLE ABIERTO, PLANCHA CM.36X68 (INCLUIDA 1 CHAPA DE CIERRE PARA TOP MOD.TPA-9)**
cm. 40x 90x 90h

⚡ 9 kW **3.290,00**
 7.740 kcal/h 81 / 0,46



FTL-94GSS Fry-top gas liscio CROMO LUCIDO, su mobile a giorno, piastra cm.36x68 (inclusa 1 testata chiusura piano mod.TPA-9)
 09230450 **EN** Gas Fry-top smooth POLISHED CHROME, on open cabinet, plate cm.36x68 (included 1 Head end filler strip mod.TPA-9) • **DE** Gas-griddleplatte glatt POLIERTEM CHROM, mit offenem Unterbau, platte cm.36x68 (inbegriffen 1 Abschluss-Element mod.TPA-9) • **FR** Plaque gaz lisse CHROME POLI, sur armoire ouvert, plaque cm.36x68 (inclus 1 Élément de jonction top mod.TPA-9) • **ES FRY-TOP GAS LISO CROMO PULIDO, SOBRE MUEBLE ABIERTO, PLANCHA CM.36X68 (INCLUIDA 1 CHAPA DE CIERRE PARA TOP MOD.TPA-9)**
cm. 40x 90x 90h

⚡ 9 kW **3.290,00**
 7.740 kcal/h 81 / 0,46



FTR-94G Fry-top gas rigato, su mobile a giorno, piastra cm.36x68 (inclusa 1 testata chiusura piano mod.TPA-9)
 09230453 **EN** Gas Fry-top grooved griddle, on open cabinet, plate cm.36x68 (included 1 Head end filler strip mod.TPA-9) • **DE** Gas-griddleplatte gerillt, mit offenem Unterbau, platte cm.36x68 (inbegriffen 1 Abschluss-Element mod.TPA-9) • **FR** Plaque gaz nervurée, sur armoire ouvert, plaque cm.36x68 (inclus 1 Élément de jonction top mod.TPA-9) • **ES FRY-TOP GAS ESTRIADO, SOBRE MUEBLE ABIERTO, PLANCHA CM.36X68 (INCLUIDA 1 CHAPA DE CIERRE PARA TOP MOD.TPA-9)**
cm. 40x 90x 90h



⚡ 9 kW **2.937,00**
 7.740 kcal/h 81 / 0,46



FRY-TOP A GAS

MOD. _____
COD. _____

DESCRIZIONE/DESCRIPTION/BEZEICHNUNG/DESCRIPTION/DESCRIPCIÓN
DIMENSIONI/DIMENSIONS/ABMESSUNGEN/DIMENSIONS/DIMENSIONES

POTENZA/POWER/LEISTUNG/PUISSANCE/POTENCIA
VOLTAGGIO/VOLTAGE/SPANNUNG/VOLTAGE/VOLTAJE

9 kW
7.740 kcal/h

PREZZO/PRICE €
PREIS/PRIX/PRECIO €
KG / M³

FTR-94GS
09230456

Fry-top gas rigato cromato SUPERCHROME (Moca Approved), su mobile a giorno, piastra cm.36x68 (inclusa 1 testata chiusura piano mod.TPA-9)
EN Gas Fry-top grooved chromed griddle SUPERCHROME (Moca Approved), on open cabinet, plate cm.36x68 (included 1 Head end filler strip mod.TPA-9) • **DE** Gas-griddleplatte gerillt hartverchromt SUPERCHROME (Moca Approved), mit offenem Unterbau, platte cm.36x68 (inbegriffen 1 Abschluss-Element mod.TPA-9) • **FR** Plaque gaz nervurée chromée SUPERCHROME (Moca Approved), sur armoire ouvert, plaque cm.36x68 (inclus 1 Élément de jonction top mod.TPA-9)
• **ES FRY-TOP GAS ESTRIADO CROMADO SUPERCHROME (MOCA APPROVED), SOBRE MUEBLE ABIERTO, PLANCHA CM.36X68 (INCLUIDA 1 CHAPA DE CIERRE PARA TOP MOD. TPA-9)**
cm. 40x 90x 90h



9 kW
7.740 kcal/h

3.483,00
81 / 0,46



FTL-98G
09230851

Fry-top gas liscio, su mobile a giorno, piastra cm.76x68 - 2 zone di cottura (inclusa 1 testata chiusura piano mod.TPA-9)
EN Gas Fry-top smooth griddle, on open cabinet, plate cm.76x68 - 2 cooking areas (included 1 Head end filler strip mod.TPA-9) • **DE** Gas-griddleplatte glatt, mit offenem Unterbau, platte cm.76x68 - 2 Heizzonen (inbegriffen 1 Abschluss-Element mod.TPA-9) • **FR** Plaque gaz lisse, sur armoire ouvert, plaque cm.76x68 - 2 zones de cuisson (inclus 1 Élément de jonction top mod.TPA-9) • **ES FRY-TOP GAS LISO, SOBRE MUEBLE ABIERTO, PLANCHA CM.76X68 - 2 ZONAS DE COCCIÓN (INCLUIDA 1 CHAPA DE CIERRE PARA TOP MOD. TPA-9)**
cm. 80x 90x 90h



18 kW
15.480 kcal/h

4.195,00
134 / 0,89



FTL-98GS
09230854

Fry-top gas liscio cromato SUPERCHROME (Moca Approved), su mobile a giorno, piastra cm.76x68 - 2 zone di cottura (inclusa 1 testata chiusura piano mod.TPA-9)
EN Gas Fry-top smooth chromed griddle SUPERCHROME (Moca Approved), on open cabinet, plate cm.76x68 - 2 cooking areas (included 1 Head end filler strip mod.TPA-9) • **DE** Gas-griddleplatte glatt hartverchromt SUPERCHROME (Moca Approved), mit offenem Unterbau, platte cm.76x68 - 2 Heizzonen (inbegriffen 1 Abschluss-Element mod.TPA-9) • **FR** Plaque gaz lisse chromée SUPERCHROME (Moca Approved), sur armoire ouvert, plaque cm.76x68 - 2 zones de cuisson (inclus 1 Élément de jonction top mod.TPA-9) • **ES FRY-TOP GAS LISO CROMADO SUPERCHROME (MOCA APPROVED), SOBRE MUEBLE ABIERTO, PLANCHA CM.76X68 - 2 ZONAS DE COCCIÓN (INCLUIDA 1 CHAPA DE CIERRE PARA TOP MOD. TPA-9)**
cm. 80x 90x 90h

18 kW
15.480 kcal/h

5.157,00
134 / 0,89



FTL-98GSS
09230850

Fry-top gas liscio CROMO LUCIDO, su mobile a giorno, piastra cm.76x68 - 2 zone di cottura (inclusa 1 testata chiusura piano mod.TPA-9)
EN Gas Fry-top smooth POLISHED CHROME, on open cabinet, plate cm.76x68 - 2 cooking areas (included 1 Head end filler strip mod.TPA-9) • **DE** Gas-griddleplatte glatt POLIERTEM CHROM, mit offenem Unterbau, platte cm.76x68 - 2 Heizzonen (inbegriffen 1 Abschluss-Element mod.TPA-9) • **FR** Plaque gaz lisse CHROME POLI, sur armoire ouvert, plaque cm.76x68 - 2 zones de cuisson (inclus 1 Élément de jonction top mod.TPA-9) • **ES FRY-TOP GAS LISO CROMO PULIDO, SOBRE MUEBLE ABIERTO, PLANCHA CM.76X68 - 2 ZONAS DE COCCIÓN (INCLUIDA 1 CHAPA DE CIERRE PARA TOP MOD. TPA-9)**
cm. 80x 90x 90h

18 kW
15.480 kcal/h

5.157,00
134 / 0,89



FTLR-98G
09230852

Fry-top gas 1/2 rigato + 1/2 liscio, su mobile a giorno, piastra cm.76x68 - 2 zone di cottura (inclusa 1 testata chiusura piano mod.TPA-9)
EN Gas Fry-top 1/2 grooved + 1/2 smooth, on open cabinet, plate cm.76x68 - 2 cooking areas (included 1 Head end filler strip mod.TPA-9) • **DE** Gas-griddleplatte 1/2 gerillt + 1/2 glatt, mit offenem Unterbau, platte cm.76x68 - 2 Heizzonen (inbegriffen 1 Abschluss-Element mod.TPA-9) • **FR** Plaque gaz 1/2 nervurée + 1/2 lisse, sur armoire ouvert, plaque cm.76x68 - 2 zones de cuisson (inclus 1 Élément de jonction top mod.TPA-9) • **ES FRY-TOP GAS 1/2 ESTRIADO + 1/2 LISO, SOBRE MUEBLE ABIERTO, PLANCHA CM.76X68 - 2 ZONAS DE COCCIÓN (INCLUIDA 1 CHAPA DE CIERRE PARA TOP MOD. TPA-9)**
cm. 80x 90x 90h



18 kW
15.480 kcal/h

4.390,00
134 / 0,89



FRY-TOP A GAS

MOD. _____ DESCRIZIONE/DESCRIPTION/BEZEICHNUNG/DESCRIPTION/DESCRIPCIÓN POTENZA/POWER/LEISTUNG/PUISSANCE/POTENCIA kW kcal/h $\frac{kW}{V}$ $\frac{kcal/h}{Hz}$ PREZZO/PRICE € PREIS/PRIX/PRECIO KG / M³
 COD. _____ DIMENSIONI/DIMENSIONS/ABMESSUNGEN/DIMENSIONS/DIMENSIONES VOLTAGGIO/VOLTAGE/SPANNUNG/VOLTAGE/VOLTAJE

FTLR-98GS Fry-top gas 1/2 rigato + 1/2 liscio cromato SUPERCHROME (Moca Approved), su mobile a giorno, piastra cm.76x68 - 2 zone di cottura (inclusa 1 testata chiusura piano mod.TPA-9)
EN Gas Fry-top 1/2 grooved + 1/2 smooth chromed griddle SUPERCHROME (Moca Approved), on open cabinet, plate cm.76x68 - 2 cooking areas (included 1 Head end filler strip mod.TPA-9) • **DE** Gas-griddleplatte 1/2 gerillt + 1/2 glatt hartverchromt SUPERCHROME (Moca Approved), mit offenem Unterbau, platte cm.76x68 - 2 Heizzonen (inbegriffen 1 Abschluss-Element mod.TPA-9) • **FR** Plaque gaz 1/2 nervurée + 1/2 lisse chromée SUPERCHROME (Moca Approved), sur armoire ouvert, plaque cm.76x68 - 2 zones de cuisson (inclus 1 Élément de jonction top mod.TPA-9) • **ES FRY-TOP GAS 1/2 ESTRIADO + 1/2 LISO CROMADO SUPERCHROME (MOCA APPROVED), SOBRE MUEBLE ABIERTO, PLANCHA CM.76X68 - 2 ZONAS DE COCCIÓN (INCLUIDA 1 CHAPA DE CIERRE PARA TOP MOD.TPA-9)**
cm. 80x 90x 90h



18 kW **5.398,00**
 15.480 kcal/h 134 / 0,89



FTR-98G Fry-top gas rigato, su mobile a giorno, piastra cm.76x68 - 2 zone di cottura (inclusa 1 testata chiusura piano mod.TPA-9)
EN Gas Fry-top grooved griddle, on open cabinet, plate cm.76x68 - 2 cooking areas (included 1 Head end filler strip mod.TPA-9) • **DE** Gas-griddleplatte gerillt, mit offenem Unterbau, platte cm.76x68 - 2 Heizzonen (inbegriffen 1 Abschluss-Element mod.TPA-9) • **FR** Plaque gaz nervurée, sur armoire ouvert, plaque cm.76x68 - 2 zones de cuisson (inclus 1 Élément de jonction top mod.TPA-9) • **ES FRY-TOP GAS ESTRIADO, SOBRE MUEBLE ABIERTO, PLANCHA CM.76X68 - 2 ZONAS DE COCCIÓN (INCLUIDA 1 CHAPA DE CIERRE PARA TOP MOD.TPA-9)**
cm. 80x 90x 90h



18 kW **4.594,00**
 15.480 kcal/h 134 / 0,89



FTR-98GS Fry-top gas rigato cromato SUPERCHROME (Moca Approved), su mobile a giorno, piastra cm.76x68 - 2 zone di cottura (inclusa 1 testata chiusura piano mod.TPA-9)
EN Gas Fry-top grooved chromed griddle SUPERCHROME (Moca Approved), on open cabinet, plate cm.76x68 - 2 cooking areas (included 1 Head end filler strip mod.TPA-9) • **DE** Gas-griddleplatte gerillt hartverchromt SUPERCHROME (Moca Approved), mit offenem Unterbau, platte cm.76x68 - 2 Heizzonen (inbegriffen 1 Abschluss-Element mod.TPA-9) • **FR** Plaque gaz nervurée chromée SUPERCHROME (Moca Approved), sur armoire ouvert, plaque cm.76x68 - 2 zones de cuisson (inclus 1 Élément de jonction top mod.TPA-9) • **ES FRY-TOP GAS ESTRIADO CROMADO SUPERCHROME (MOCA APPROVED), SOBRE MUEBLE ABIERTO, PLANCHA CM.76X68 - 2 ZONAS DE COCCIÓN (INCLUIDA 1 CHAPA DE CIERRE PARA TOP MOD.TPA-9)**
cm. 80x 90x 90h

18 kW **5.640,00**
 15.480 kcal/h 134 / 0,89



FTL-912G Fry-top gas liscio, su mobile a giorno, piastra cm.110,5x65 - 3 zone di cottura (inclusa 1 testata chiusura piano mod.TPA-9)
EN Gas Fry-top smooth griddle, on open cabinet, plate cm.110,5x65 - 3 cooking areas (included 1 Head end filler strip mod.TPA-9) • **DE** Gas-griddleplatte glatt, mit offenem Unterbau, platte cm.110,5x65 - 3 Heizzonen (inbegriffen 1 Abschluss-Element mod.TPA-9) • **FR** Plaque gaz lisse, sur armoire ouvert, plaque cm.110,5x65 - 3 zones de cuisson (inclus 1 Élément de jonction top mod.TPA-9) • **ES FRY-TOP GAS LISO, SOBRE MUEBLE ABIERTO, PLANCHA CM.110,5X65 - 3 ZONAS DE COCCIÓN (INCLUIDA 1 CHAPA DE CIERRE PARA TOP MOD.TPA-9)**
cm. 120x 90x 90h



27 kW **6.616,00**
 23.220 kcal/h 198 / 1,32



FRY-TOP A GAS

MOD. _____
COD. _____

DESCRIZIONE/DESCRIPTION/BEZEICHNUNG/DESCRIPTION/DESCRIPCIÓN
DIMENSIONI/DIMENSIONS/ABMESSUNGEN/DIMENSIONS/DIMENSIONES

POTENZA/POWER/LEISTUNG/PUISSANCE/POTENCIA
VOLTAGGIO/VOLTAGE/SPANNUNG/VOLTAGE/VOLTAJE

⚡ kW
kcal/h

⚡ kW
V-
Hz

PREZZO/PRICE
PREIS/PRIX/PRECIO €
KG / M³

FTL-912GS Fry-top gas liscio cromato SUPERCHROME (Moca Approved), su mobile a giorno, piastra cm.110,5x65 - 3 zone di cottura (inclusa 1 testata chiusura piano mod.TPA-9)
0923125E

EN Gas Fry-top smooth chromed griddle SUPERCHROME (Moca Approved), on open cabinet, plate cm.110,5x65 - 3 cooking areas (included 1 Head end filler strip mod.TPA-9) • **DE** Gas-griddleplatte glatt hartverchromt SUPERCHROME (Moca Approved), mit offenem Unterbau, platte cm.110,5x65 - 3 Heizzonen (inbegriffen 1 Abschluss-Element mod.TPA-9) • **FR** Plaque gaz lisse chromée SUPERCHROME (Moca Approved), sur armoire ouvert, plaque cm.110,5x65 - 3 zones de cuisson (inclus 1 Élément de jonction top mod.TPA-9) • **ES FRY-TOP GAS LISO CROMADO SUPERCHROME (MOCA APPROVED), SOBRE MUEBLE ABIERTO, PLANCHA CM.110,5X65 - 3 ZONAS DE COCCIÓN (INCLUIDA 1 CHAPA DE CIERRE PARA TOP MOD.TPA-9)**

cm. 120x 90x 90h



⚡ 27 kW
23.220 kcal/h

7.542,00
198 / 1,32

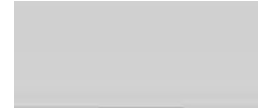

FTLR-912G Fry-top gas 1/3 rigato + 2/3 liscio, su mobile a giorno, piastra cm.110,5x65 - 3 zone di cottura (inclusa 1 testata chiusura piano mod.TPA-9)
0923125C

EN Gas Fry-top 1/3 grooved + 2/3 smooth, on open cabinet, plate cm.110,5x65 - 3 cooking areas (included 1 Head end filler strip mod.TPA-9) • **DE** Gas-griddleplatte 1/3 gerillt + 2/3 glatt, mit offenem Unterbau, platte cm.110,5x65 - 3 Heizzonen (inbegriffen 1 Abschluss-Element mod.TPA-9) • **FR** Plaque gaz 1/3 nervurée + 2/3 lisse, sur armoire ouvert, plaque cm.110,5x65 - 3 zones de cuisson (inclus 1 Élément de jonction top mod.TPA-9) • **ES FRY-TOP GAS 1/3 ESTRIADO + 2/3 LISO, SOBRE MUEBLE ABIERTO, PLANCHA CM.110,5X65 - 3 ZONAS DE COCCIÓN (INCLUIDA 1 CHAPA DE CIERRE PARA TOP MOD.TPA-9)**

cm. 120x 90x 90h



⚡ 27 kW
23.220 kcal/h

7.007,00
198 / 1,32



FTLR-912GS Fry-top gas 1/3 rigato + 2/3 liscio cromato SUPERCHROME (Moca Approved), su mobile a giorno, piastra cm.110,5x65 - 3 zone di cottura (inclusa 1 testata chiusura piano mod.TPA-9)
0923125F

EN Gas Fry-top 1/3 grooved + 2/3 smooth chromed SUPERCHROME (Moca Approved), on open cabinet, plate cm.110,5x65 - 3 cooking areas (included 1 Head end filler strip mod.TPA-9) • **DE** Gas-griddleplatte 1/3 gerillt + 2/3 glatt hartverchromt SUPERCHROME (Moca Approved), mit offenem Unterbau, platte cm.110,5x65 - 3 Heizzonen (inbegriffen 1 Abschluss-Element mod.TPA-9) • **FR** Plaque gaz 1/3 nervurée + 2/3 lisse chromée AW770:AW833approved), sur armoire ouvert, plaque cm.110,5x65 - 3 zones de cuisson (inclus 1 Élément de jonction top mod.TPA-9) • **ES FRY-TOP GAS 1/3 ESTRIADO + 2/3 LISO CROMADO SUPERCHROME (MOCA APPROVED), SOBRE MUEBLE ABIERTO, PLANCHA CM.110,5X65 - 3 ZONAS DE COCCIÓN (INCLUIDA 1 CHAPA DE CIERRE PARA TOP MOD.TPA-9)**

cm. 120x 90x 90h

⚡ 27 kW
23.220 kcal/h

7.935,00
198 / 1,32



FTL-916G Fry-top gas liscio, su mobile a giorno, piastra cm.150,5x65 - 4 zone di cottura (inclusa 1 testata chiusura piano mod.TPA-9)
09231651

EN Gas Fry-top smooth griddle, on open cabinet, plate cm.150,5x65 - 4 cooking areas (included 1 Head end filler strip mod.TPA-9) • **DE** Gas-griddleplatte glatt, mit offenem Unterbau, platte cm.150,5x65 - 4 Heizzonen (inbegriffen 1 Abschluss-Element mod.TPA-9) • **FR** Plaque gaz lisse, sur armoire ouvert, plaque cm.150,5x65 - 4 zones de cuisson (inclus 1 Élément de jonction top mod.TPA-9) • **ES FRY-TOP GAS LISO, SOBRE MUEBLE ABIERTO, PLANCHA CM.150,5X65 - 4 ZONAS DE COCCIÓN (INCLUIDA 1 CHAPA DE CIERRE PARA TOP MOD.TPA-9)**

cm. 160x 90x 90h



⚡ 36 kW
30.960 kcal/h

8.399,00
266 / 1,76



FRY-TOP A GAS

MOD. _____
COD. _____

DESCRIZIONE/DESCRIPTION/BEZEICHNUNG/DESCRIPTION/DESCRIPCIÓN
DIMENSIONI/DIMENSIONS/ABMESSUNGEN/DIMENSIONS/DIMENSIONES

POTENZA/POWER/LEISTUNG/PUISSANCE/POTENCIA
VOLTAGGIO/VOLTAGE/SPANNUNG/VOLTAGE/VOLTAJE

⚡ kW
kcal/h

⚡ kW
V~
Hz

PREZZO/PRICE €
PREIS/PRIX/PRECIO €
KG / M³

FTL-916GS
09231654

Fry-top gas liscio cromato SUPERCHROME (Moca Approved), su mobile a giorno, piastra cm.150,5x65 - 4 zone di cottura (inclusa 1 testata chiusura piano mod.TPA-9)

EN Gas Fry-top smooth chromed griddle SUPERCHROME (Moca Approved), on open cabinet, plate cm.150,5x65 - 4 cooking areas (included 1 Head end filler strip mod.TPA-9) • **DE** Gas-griddleplatte glatt hartverchromt SUPERCHROME (Moca Approved), mit offenem Unterbau, platte cm.150,5x65 - 4 Heizzonen (inbegriffen 1 Abschluss-Element mod.TPA-9) • **FR** Plaque gaz lisse chromée SUPERCHROME (Moca Approved), sur armoire ouvert, plaque cm.150,5x65 - 4 zones de cuisson (inclus 1 Élément de jonction top mod.TPA-9) • **ES FRY-TOP GAS LISO CROMADO SUPERCHROME (MOCA APPROVED), SOBRE MUEBLE ABIERTO, PLANCHA CM.150,5X65 - 4 ZONAS DE COCCIÓN (INCLUIDA 1 CHAPA DE CIERRE PARA TOP MOD.TPA-9)**

cm. 160x 90x 90h



⚡ 36 kW
30.960 kcal/h

9.601,00
266 / 1,76



CWK-94ET
09080431

GRIGLIA CONTACT SU MOBILE A GIORNO - cottura diretta su resistenza in acciaio inox cm. 27x63 ribaltabile (inclusa 1 testata chiusura piano mod.TPA-9)

EN CONTACT Grill threephase on open cabinet - rotatable stainless steel grill cm. 27x63 (included 1 Head end filler strip mod.TPA-9) • **DE** Wurstbrater dreiphasig KONTAKT mit offenem Unterbau - Drehbaren Heizelement aus Edelstahl cm. 27x63 (inbegriffen 1 Abschluss-Element mod.TPA-9) • **FR** Grillade triphase CONTACT sur armoire ouvert- Grille inox rotatif cm 27x63 (inclus 1 Élément de jonction top mod.TPA-9) • **ES PARRILLA TRIFÁSICO CONTACT SOBRE MUEBLE ABIERTO - PARRILLA GIRATORIA DE ACERO INOX CM 27X63 (INCLUIDA 1 CHAPA DE CIERRE PARA TOP MOD.TPA-9)**

cm. 40x 90x 90h



⚡ 5,415 kW
400V~3N
50/60 Hz

3.768,00
69 / 0,46

CWK-98ET
09080831

GRIGLIA CONTACT SU MOBILE A GIORNO - cottura diretta su resistenza in acciaio inox cm. 55x63 ribaltabile - 2 zone di cottura (inclusa 1 testata chiusura piano mod.TPA-9)

EN CONTACT Grill threephase on open cabinet - rotatable stainless steel grill cm. 55x63 - 2 cooking areas (included 1 Head end filler strip mod.TPA-9) • **DE** Wurstbrater dreiphasig KONTAKT mit offenem Unterbau - Drehbaren Heizelement aus Edelstahl cm. 55x63 - 2 Heizzonen (inbegriffen 1 Abschluss-Element mod.TPA-9) • **FR** Grillade triphase CONTACT sur armoire ouvert- Grille inox rotatif cm 55x63 - 2 zones de cuisson (inclus 1 Élément de jonction top mod.TPA-9) • **ES PARRILLA TRIFÁSICO CONTACT SOBRE MUEBLE ABIERTO - PARRILLA GIRATORIA DE ACERO INOX CM 55X63 - 2 ZONAS DE COCCIÓN (INCLUIDA 1 CHAPA DE CIERRE PARA TOP MOD. TPA-9)**

cm. 80x 90x 90h



⚡ 10,83 kW
400V~3N
50/60 Hz

5.168,00
105 / 0,89

CW-94ET
09080430

GRIGLIA TRIFASE SU MOBILE A GIORNO Griglia in acciaio inox cm. 38x66 regolabile (inclusa 1 testata chiusura piano mod.TPA-9)

EN Grill threephase on open cabinet Stainless steel adjustable grill cm. 38x66 (included 1 Head end filler strip mod.TPA-9) • **DE** Wurstbrater dreiphasig mit offenem Unterbau Einstellbarer Rost aus Nirosta cm. 38x66 (inbegriffen 1 Abschluss-Element mod.TPA-9) • **FR** Grillade triphase sur armoire ouvert Grille réglable en acier inox cm 38x66 (inclus 1 Élément de jonction top mod.TPA-9) • **ES PARRILLA TRIFÁSICO SOBRE MUEBLE ABIERTO PARRILLA DE ACERO INOX REGULABLE CM 38X66 (INCLUIDA 1 CHAPA DE CIERRE PARA TOP MOD. TPA-9)**

cm. 40x 90x 90h



⚡ 7,8 kW
400V~3N
50/60 Hz

2.965,00
71 / 0,46

CW-98ET
09080830

GRIGLIA TRIFASE SU MOBILE A GIORNO N. 2 griglie in acciaio inox cm. 38x66 regolabili 2 zone di cottura (inclusa 1 testata chiusura piano mod. TPA-9)

EN Grill threephase on open cabinet - N. 2 stainless steel adjustable grills cm. 38x66 - 2 cooking areas (included 1 Head end filler strip mod.TPA-9) • **DE** Wurstbrater dreiphasig mit offenem Unterbau - N. 2 einstellbarer Roste aus Nirosta cm. 38x66 - 2 Heizzonen (inbegriffen 1 Abschluss-Element mod.TPA-9) • **FR** Grillade triphase sur armoire ouvert - N. 2 grilles réglable en acier inox cm. 38x66 - 2 zones de cuisson (inclus 1 Élément de jonction top mod.TPA-9) • **ES PARRILLA TRIFÁSICO SOBRE MUEBLE ABIERTO - N. 2 PARRILLAS DE ACERO INOX REGULABLE CM 38X66 - 2 ZONAS DE COCCIÓN (INCLUIDA 1 CHAPA DE CIERRE PARA TOP MOD.TPA-9)**

cm. 80x 90x 90h



⚡ 15,6 kW
400V~3N
50/60 Hz

4.375,00
109 / 0,89

GRIGLIE PIETRA LAVICA A GAS

MOD. _____
COD. _____

DESCRIZIONE/DESCRIPTION/BEZEICHNUNG/DESCRIPTION/DESCRIPCIÓN
DIMENSIONI/DIMENSIONS/ABMESSUNGEN/DIMENSIONS/DIMENSIONES

POTENZA/POWER/LEISTUNG/PUISSANCE/POTENCIA
VOLTAGGIO/VOLTAGE/SPANNUNG/VOLTAGE/VOLTAJE

⚡ kW _____
kcal/h _____
V~ _____
Hz _____

PREZZO/PRICE
PREIS/PRIX/PRECIO €
KG / M³

CW-94G
09250450

GRIGLIA GAS-PIETRALAVICA SU MOBILE A GIORNO Griglia in acciaio inox cm. 38x66 regolabile (inclusa 1 testata chiusura piano mod.TPA-9)
EN Charcoal grill gas on open cabinet - Stainless steel adjustable grill cm. 38x66 (included 1 Head end filler strip mod.TPA-9) • **DE** Gas-Lavasteingrill mit offenem Unterbau - Einstellbarer Rost aus Nirosa cm. 38x66 (inbegriffen 1 Abschluss-Element mod.TPA-9) • **FR** Grille a gaz en pierre de lave sur armoire ouvert - Grille réglable en acier inox cm. 38x66 (inclus 1 Élément de jonction top mod.TPA-9) • **ES PARRILLA A GAS PIEDRA LÁVICA SOBRE MUEBLE ABIERTO - PARRILLA DE ACERO INOX REGULABLE 38X66 CM (INCLUIDA 1 CHAPA DE CIERRE PARA TOP MOD.TPA-9)**
cm. 40x 90x 90h



⚡ 12 kW _____ **2.887,00**
10.320 kcal/h _____ 77 / 0,46

CW-98G
09250850

GRIGLIA GAS-PIETRALAVICA SU MOBILE A GIORNO N. 2 griglie in acciaio inox cm. 38x66 regolabili 2 zone di cottura (inclusa 1 testata chiusura piano mod.TPA-9)
EN Charcoal grill gas on open cabinet - N. 2 stainless steel adjustable grills cm. 38x66 - 2 cooking areas (included 1 Head end filler strip mod.TPA-9) • **DE** Gas-Lavasteingrill mit offenem Unterbau - N. 2 einstellbarer Roste aus Nirosa cm. 38x66 - 2 Heizzonen (inbegriffen 1 Abschluss-Element mod.TPA-9) • **FR** Grille à gaz en pierre de lave sur armoire ouvert N. 2 grilles en acier inox cm 38x66 - 2 zones de cuisson (inclus 1 Élément de jonction top mod.TPA-9) • **ES PARRILLA A GAS PIEDRA LÁVICA SOBRE MUEBLE ABIERTO N. 2 PARRILLA DE ACERO INOX REGULABLE CM 38X66 - 2 ZONAS DE COCCION (INCLUIDA 1 CHAPA DE CIERRE PARA TOP MOD.TPA-9)**
cm. 80x 90x 90h



⚡ 24 kW _____ **4.488,00**
20.640 kcal/h _____ 131 / 0,89

F2/8-94ET
09090432

FRIGGITRICE TRIFASE LT. 8+8 2 Vasche cm. 14,8x35x32,7h 2 cesti cm. 12x30x15h - Filtro e coperchio vasca. Produzione patate: 12 kg/h (bacinella raccogliolio esclusa, vedi mod: BF30) (inclusa 1 testata chiusura piano mod.TPA-9)
EN Fryer threephase 8+8 lts - 2 Bowls cm. 14,8x35x32,7h - 2 baskets cm. 12x30x15h. Sieve and lid for pan. Production: 12 kg/h (Drip tray excluded, see mod: BF30) (included 1 Head end filler strip mod.TPA-9) • **DE** Friteuse dreiphasig lt. 8+8 - 2 Becken cm. 14,8x35x32,7h - 2 Korb cm. 12x30x15h. Einlegesieb und Deckel für Becken. Pommes frites: 12 kg/h (Fettauffangschale ausgeschlossen, sehen mod: BF30) (inbegriffen 1 Abschluss-Element mod.TPA-9) • **FR** Friteuse triphase lt. 8+8 - 2 Cuve cm. 14,8x35x32,7h - 2 Panier cm. 12x30x15h. Filtre, couvercle pour cuve. Production de pommes frites: 12 kg/h (Bac de récupération de l'huile exclus, voir mod: BF30) (inclus 1 Élément de jonction top mod.TPA-9) • **ES FREIDORAS TRIFÁSICO 8+8 LT. - 2CUBA CM. 14,8X35X32,7H - 2 CESTA CM. 12X30X15HH. FILTRO Y TAPA PARA CUBA. PROD. PATATAS: 12 KG/H (BANDEJA RECOGE ACEITE EXCLUIDA, VER MOD: BF30) (INCLUIDA 1 CHAPA DE CIERRE PARA TOP MOD.TPA-9)**
cm. 40x 90x 90h



⚡ 12 kW _____ **4.314,00**
400V~3N _____ 63 / 0,46
230V~3 _____
50/60 Hz _____

F18-94ET
09090430

FRIGGITRICE TRIFASE LT. 18 Vasca cm. 31x34x33h 1 cesto cm. 28x29x15h Coperchio vasca - Prod. patate: 15 kg/h (bacinella raccogliolio esclusa, vedi mod: BF30) (inclusa 1 testata chiusura piano mod.TPA-9)
EN Fryer threephase 18 lts. - Bowl cm. 31x34x33h 1 basket cm. 28x29x15h - Lid for pan - Production: 15 kg/h (Drip tray excluded, see mod: BF30) (included 1 Head end filler strip mod.TPA-9) • **DE** Friteuse dreiphasig lt. 18 - Becken cm. 31x34x33h 1 Korb cm. 28x29x15h - Deckel für Becken - Pommes frites: 15 kg/h (Fettauffangschale ausgeschlossen, sehen mod: BF30) (inbegriffen 1 Abschluss-Element mod.TPA-9) • **FR** Friteuse triphase lt. 18 - Cuve cm. 31x34x33h 1 Panier cm. 28x29x15h Couvercle pour cuve - Production de pommes frites: 15 kg/h (Bac de récupération de l'huile exclus, voir mod: BF30) (inclus 1 Élément de jonction top mod.TPA-9) • **ES FREIDORAS TRIFÁSICO 18 LT. - CUBA CM. 31X34X33H 1 CESTA CM. 28X29X15H - TAPA PARA CUBA PRODUCCIÓN PATATAS: 15 KG/H (BANDEJA RECOGE ACEITE EXCLUIDA, VER MOD: BF30) (INCLUIDA 1 CHAPA DE CIERRE PARA TOP MOD.TPA-9)**
cm. 40x 90x 90h



⚡ 15,9 kW _____ **3.389,00**
400V~3N _____ 63 / 0,46
50/60 Hz _____

FRIGGITRICI ELETTRICHE

MOD. _____ DESCRIZIONE/DESCRIPTION/BEZEICHNUNG/DESCRIPTION/DESCRIPCIÓN POTENZA/POWER/LEISTUNG/PUISSANCE/POTENCIA ⚡kW ⚡kw PREZZO/PRICE €
 COD. _____ DIMENSIONI/DIMENSIONS/ABMESSUNGEN/DIMENSIONS/DIMENSIONES VOLTAGGIO/VOLTAGE/SPANNUNG/VOLTAGE/VOLTAJE kcal/h kcal/h V~ V~ PREIS/PRIX/PRECIO €
 KG / M³

F25-94ET FRIGGITRICE TRIFASE LT. 25 Vasca cm. 31x51x33h - 2 cesti cm.
 09090431 13,5x45x15h Coperchio vasca - Prod. patate: 25 kg/h (bacinella raccogliolio esclusa, vedi mod: BF30) (inclusa 1 testata chiusura piano mod.TPA-9)
EN Fryer threephase 25 lts. - Bowl cm. 31x51x33h 2 baskets cm. 13,5x45x15h - Lid for tank Production: 25 kg/h (Drip tray excluded, see mod: BF30) (included 1 Head end filler strip mod.TPA-9) • **DE** Friteuse dreiphasig lt. 25 - Becken cm. 31x51x33h 2 Körbe cm. 13,5x45x15h - Deckel für Becken Pommes frites: 25 kg/h (Fettauffangschale ausgeschlossen, sehen mod: BF30) (inbegriffen 1 Abschluss-Element mod. TPA-9) • **FR** Friteuse triphase lt. 25 - Cuve cm. 31x51x33h 2 Paniers cm. 13,5x45x15h - Couvercle pour cuve Production de pommes frites: 25 kg/h (Bac de récupération de l'huile exclus, voir mod: BF30) (inclus 1 Élément de jonction top mod.TPA-9) • **ES FREIDORAS TRIFÁSICO 25 LT. - CUBA CM. 31X51X33H 2 CESTAS CM. 13,5X45X15H - TAPA PARA CUBA PRODUCCIÓN PATATAS: 25 KG/H (BANDEJA RECOGE ACEITE EXCLUIDA, VER MOD: BF30) (INCLUIDA 1 CHAPA DE CIERRE PARA TOP MOD.TPA-9) cm. 40x 90x 90h**



⚡ 22 kW **3.714,00**
 400V~3N 66 / 0,46
 50/60 Hz

F2/18-98ET FRIGGITRICE TRIFASE LT. 18+18 2 vasche cm. 31x34x33h - 2 cesti
 09090830 cm. 28x29x15h 2 coperchi vasche - Prod. patate: 30 kg/h (bacinella raccogliolio esclusa, vedi mod: BF30) (inclusa 1 testata chiusura piano mod.TPA-9)
EN Fryer threephase 18+18 lts - 2 pans cm. 31x34x33h 2 baskets cm. 28x29x15h - 2 lids for tank Production: 30 kg/h (Drip tray excluded, see mod: BF30) (included 1 Head end filler strip mod.TPA-9) • **DE** Friteuse dreiphasig lt. 18+18 - 2 Becken cm. 31x34x33h 2 Körbe cm. 28x29x15h - 2 Deckel für Becken Pommes frites: 30 kg/h (Fettauffangschale ausgeschlossen, sehen mod: BF30) (inbegriffen 1 Abschluss-Element mod. TPA-9) • **FR** Friteuse triphase lt. 18+18 - 2 cuves cm. 31x34x33h 2 paniers cm. 28x29x15h - 2 couvercles pour cuve Production de pommes frites: 30 kg/h (Bac de récupération de l'huile exclus, voir mod: BF30) (inclus 1 Élément de jonction top mod.TPA-9) • **ES FREIDORAS TRIFÁSICO 18+18 LT. - 2 CUBAS CM. 31X34X33H 2 CESTAS CM. 28X29X15H - 2 TAPAS PARA CUBA PRODUCCIÓN PATATAS: 30 KG/H (BANDEJA RECOGE ACEITE EXCLUIDA, VER MOD: BF30) (INCLUIDA 1 CHAPA DE CIERRE PARA TOP MOD.TPA-9) cm. 80x 90x 90h**



⚡ 31,8 kW **5.378,00**
 400V~3N 106 / 0,89
 50/60 Hz

F2/25-98ET FRIGGITRICE TRIFASE LT. 25+25 2 vasche cm. 31x51x33h - 4 cesti cm.
 09090831 13,5x45x15h 2 coperchi vasche - Prod. patate: 50 kg/h (bacinella raccogliolio esclusa, vedi mod: BF30) (inclusa 1 testata chiusura piano mod.TPA-9)
EN Fryer threephase 25+25 lts. - 2 pans cm. 31x51x33h 4 baskets cm. 13,5x45x15h - 2 lids for tank Production: 50 kg/h (Drip tray excluded, see mod: BF30) (included 1 Head end filler strip mod.TPA-9) • **DE** Friteuse dreiphasig lt. 25+25 - 2 Becken cm. 31x51x33h 4 Körbe cm. 13,5x45x15h - 2 Deckel für Becken Pommes frites: 50 kg/h (Fettauffangschale ausgeschlossen, sehen mod: BF30) (inbegriffen 1 Abschluss-Element mod.TPA-9) • **FR** Friteuse triphase lt. 25+25 - 2 cuves cm. 31x51x33h 4 paniers cm. 13,5x45x15h - 2 couvercles pour cuve Production de pommes frites: 50 kg/h (Bac de récupération de l'huile exclus, voir mod: BF30) (inclus 1 Élément de jonction top mod. TPA-9) • **ES FREIDORAS TRIFÁSICO 25+25 LT. - 2 CUBAS CM. 31X51X33H 4 CESTAS CM. 13,5X45X15H - 2 TAPAS PARA CUBA PRODUCCIÓN PATATAS: 50 KG/H (BANDEJA RECOGE ACEITE EXCLUIDA, VER MOD: BF30) (INCLUIDA 1 CHAPA DE CIERRE PARA TOP MOD.TPA-9) cm. 80x 90x 90h**

⚡ 44 kW **6.008,00**
 400V~3N 114 / 0,89
 50/60 Hz

FRIGGITRICI A GAS

MOD. _____
COD. _____

DESCRIZIONE/DESCRIPTION/BEZEICHNUNG/DESCRIPTION/DESCRIPCIÓN
DIMENSIONI/DIMENSIONS/ABMESSUNGEN/DIMENSIONS/DIMENSIONES

POTENZA/POWER/LEISTUNG/PUISSANCE/POTENCIA
VOLTAGGIO/VOLTAGE/SPANNUNG/VOLTAGE/VOLTAJE

⚡ kW
kcal/h

PREZZO/PRICE
PREIS/PRIX/PRECIO €
KG / M³

F2/8-94G
09260452

FRIGGITRICE GAS LT. 8+8 - 2 vasche cm. 15x35x36h 2 cesti cm. 12x30x15h. Filtro e coperchio vasca. Prod. patate: 12 kg/h (bacinella raccogliolio esclusa, vedi mod: BF30) (inclusa 1 testata chiusura piano mod.TPA-9)

EN Gas Fryer 8+8 lts - 2 pans cm. 15x35x36h 2 baskets cm. 12x30x15h. Sieve and lid for pan. Production: 12 kg/h (Drip tray excluded, see mod: BF30) (included 1 Head end filler strip mod.TPA-9)
• DE Gas-Friteuse lt. 8+8 - 2 Becken cm. 15x35x36h 2 Körbe cm. 12x30x15h. Einlegesieb und Deckel für Becken. Pommes frites: 12 kg/h (Fettauffangschale ausgeschlossen, sehen mod: BF30) (inbegriffen 1 Abschluss-Element mod.TPA-9) **• FR** Friteuse à gaz lt. 8+8 - 2 cuves cm. 15x35x36h 2 paniers cm. 12x30x15h. Filtre, couvercle pour cuve. Production de pommes frites: 12 kg/h (Bac de récupération de l'huile exclus, voir mod: BF30) (inclus 1 Élément de jonction top mod.TPA-9)
• ES FREIDORAS A GAS 8+8 LT. - 2 CUBAS CM. 15X35X36H 2 CESTAS CM. 12X30X15H. FILTRO Y TAPA PARA CUBA. PROD. PATATAS: 12 KG/H (BANDEJA RECOGE ACEITE EXCLUIDA, VER MOD: BF30) (INCLUIDA 1 CHAPA DE CIERRE PARA TOP MOD.TPA-9)
cm. 40x 90x 90h



⚡ 10 kW
8.600 kcal/h

4.958,00
63 / 0,46

F18-94G
09260450

FRIGGITRICE GAS LT. 18 Vasca cm. 24x51x44h - 1 cesto cm. 21x45x15h Coperchio vasca - Prod. patate: 15 kg/h (bacinella raccogliolio esclusa, vedi mod: BF30) (inclusa 1 testata chiusura piano mod.TPA-9)

EN Gas fryer 18 lts. - Bowl cm. 24x51x44h 1 basket cm. 21x45x15h - Lid for tank Production: 15 kg/h (Drip tray excluded, see mod: BF30) (included 1 Head end filler strip mod.TPA-9) **• DE** Gas-Friteuse lt. 18 - Becken cm. 24x51x44h 1 Korb cm. 21x45x15h - Deckel für Becken Pommes frites: 15 kg/h (Fettauffangschale ausgeschlossen, sehen mod: BF30) (inbegriffen 1 Abschluss-Element mod.TPA-9) **• FR** Friteuse à gaz lt. 18 - Cuve cm. 24x51x44h 1 Panier cm. 21x45x15h - Couvercle pour cuve Production de pommes frites: 15 kg/h (Bac de récupération de l'huile exclus, voir mod: BF30) (inclus 1 Élément de jonction top mod.TPA-9)
• ES FREIDORAS A GAS 18 LT. - CUBA CM. 24X51X44H 1 CESTA CM. 21X45X15H - TAPA PARA CUBA PRODUCCIÓN PATATAS: 15 KG/H (BANDEJA RECOGE ACEITE EXCLUIDA, VER MOD: BF30) (INCLUIDA 1 CHAPA DE CIERRE PARA TOP MOD.TPA-9)
cm. 40x 90x 90h



⚡ 15 kW
12.900 kcal/h

3.853,00
69 / 0,46

⚡ 0,005 kW
230V~
50 Hz

F25-94G
09260451

FRIGGITRICE GAS LT. 25 Vasca cm. 31x51x44h - 2 cesti cm. 13,5x45x15h Coperchio vasca - Prod. patate: 25 kg/h (bacinella raccogliolio esclusa, vedi mod: BF30) (inclusa 1 testata chiusura piano mod.TPA-9)

EN Gas fryer 25 lts - Pan cm. 31x51x44h 2 baskets cm. 13,5x45x15h - Lid for tank Production: 25 kg/h. (Drip tray excluded, see mod: BF30) (included 1 Head end filler strip mod.TPA-9) **• DE** Gas-Friteuse lt. 25 - Becken cm. 31x51x44h 2 Körbe cm. 13,5x45x15h - Deckel für Becken Production: 25 kg/h (Fettauffangschale ausgeschlossen, sehen mod: BF30) (inbegriffen 1 Abschluss-Element mod.TPA-9) **• FR** Friteuse à gaz lt. 25 - Cuve cm. 31x51x44h 2 Paniers cm. 13,5x45x15h - Couvercle pour cuve Pommes frites: 25 kg/h (Bac de récupération de l'huile exclus, voir mod: BF30) (inclus 1 Élément de jonction top mod.TPA-9) **• ES FREIDORAS A GAS 25 LT. - CUBA CM. 31X51X44H 2 CESTAS CM. 13,5X45X15H - TAPA PARA CUBA PRODUCCIÓN PATATAS: 25 KG/H (BANDEJA RECOGE ACEITE EXCLUIDA, VER MOD: BF30) (INCLUIDA 1 CHAPA DE CIERRE PARA TOP MOD. TPA-9)**
cm. 40x 90x 90h

⚡ 20 kW
17.200 kcal/h

4.187,00
75 / 0,46

⚡ 0,005 kW
230V~
50 Hz

FRIGGITRICI A GAS

MOD. COD.	DESCRIZIONE/DESCRIPTION/BEZEICHNUNG/DESCRIPTION/DESCRIPCIÓN DIMENSIONI/DIMENSIONS/ABMESSUNGEN/DIMENSIONS/DIMENSIONES	POTENZA/POWER/LEISTUNG/PUISSANCE/POTENCIA VOLTAGGIO/VOLTAGE/SPANNUNG/VOLTAGE/VOLTAJE	$\frac{\text{kW}}{\text{kcal/h}}$ $\frac{\text{kV}}{\text{V}}$ $\frac{\text{Hz}}{\text{Hz}}$	PREZZO/PRICE € KG / M ³
---------------------	---	---	---	--

F2/18-98G FRIGGITRICE GAS LT. 18+18 2 vasche cm. 24x51x44h - 2 cesti cm. 21x45x15h 2 coperchi vasche - Prod. patate: 30 kg/h (bacinella raccogliolio esclusa, vedi mod: BF30) (inclusa 1 testata chiusura piano mod.TPA-9)

EN Fryer gas 18+18 lts - 2 pans cm. 24x51x44h 2 baskets cm. 21x45x15h - 2 lids for tank Production: 30 kg/h (Drip tray excluded, see mod: BF30) (included 1 Head end filler strip mod.TPA-9) • **DE** Gas-Friteuse dreiphasig lt. 18+18 - 2 Becken cm. 24x51x44h 2 Körbe cm. 21x45x15h - 2 Deckel für Becken Pommes frites: 30 kg/h (Fettauffangschale ausgeschlossen, sehen mod: BF30) (inbegriffen 1 Abschluss-Element mod.TPA-9) • **FR** Friteuse à gaz lt. 18+18 - 2 cuves cm. 24x51x44h 2 paniers cm. 21x45x15h - 2 couvercles pour cuve Production de pommes frites: 30 kg/h (Bac de récupération de l'huile exclus, voir mod: BF30) (inclus 1 Élément de jonction top mod. TPA-9) • **ES FREIDORAS A GAS 18+18 LT. - 2 CUBAS CM. 24X51X44H 2 CESTAS CM. 21X45X15H - 2 TAPAS PARA CUBA PRODUCCIÓN PATATAS: 30 KG/H (BANDEJA RECOGE ACEITE EXCLUIDA, VER MOD: BF30) (INCLUIDA 1 CHAPA DE CIERRE PARA TOP MOD.TPA-9)**
cm. 80x 90x 90h



$\frac{\text{kW}}{\text{kcal/h}}$	30 kW 25.770 kcal/h	6.080,00
$\frac{\text{kV}}{\text{V}}$	0,01 kW	116 / 0,89
$\frac{\text{Hz}}{\text{Hz}}$	230V~ 50 Hz	

F2/25-98G FRIGGITRICE GAS LT. 25+25 2 vasche cm. 31x51x44h - 4 cesti cm. 13,5x45x15h 2 coperchi vasche - Prod. patate: 50 kg/h (bacinella raccogliolio esclusa, vedi mod: BF30) (inclusa 1 testata chiusura piano mod.TPA-9)

EN Fryer gas 25+25 lts - 2 pans cm. 31x51x44h 4 baskets cm. 13,5x45x15h - 2 lids for tank Production: 50 kg/h (Drip tray excluded, see mod: BF30) (included 1 Head end filler strip mod.TPA-9) • **DE** Gas-Friteuse dreiphasig lt. 25+25 - 2 Becken cm. 31x51x44h 4 Körbe cm. 13,5x45x15h - 2 Deckel für Becken Pommes frites: 50 kg/h (Fettauffangschale ausgeschlossen, sehen mod: BF30) (inbegriffen 1 Abschluss-Element mod.TPA-9) • **FR** Friteuse à gaz lt. 25+25 - 2 cuves cm. 31x51x44h 4 paniers cm. 13,5x45x15h - 2 couvercles pour cuve Production de pommes frites: 50 kg/h (Bac de récupération de l'huile exclus, voir mod: BF30) (inclus 1 Élément de jonction top mod. TPA-9) • **ES FREIDORAS A GAS 25+25 LT. - 2 CUBAS CM. 31X51X44H 4 CESTAS CM. 13,5X45X15H - 2 TAPAS PARA CUBA PRODUCCIÓN PATATAS: 50 KG/H (BANDEJA RECOGE ACEITE EXCLUIDA, VER MOD: BF30) (INCLUIDA 1 CHAPA DE CIERRE PARA TOP MOD.TPA-9)**
cm. 80x 90x 90h

$\frac{\text{kW}}{\text{kcal/h}}$	40 kW 34.360 kcal/h	6.810,00
$\frac{\text{kV}}{\text{V}}$	0,01 kW	126 / 0,89
$\frac{\text{Hz}}{\text{Hz}}$	230V~ 50 Hz	

FRIGGITRICI ELETTRICHE DIGITALI

MOD. _____
COD. _____

DESCRIZIONE/DESCRIPTION/BEZEICHNUNG/DESCRIPTION/DESCRIPCIÓN
DIMENSIONI/DIMENSIONS/ABMESSUNGEN/DIMENSIONS/DIMENSIONES

POTENZA/POWER/LEISTUNG/PUISSANCE/POTENCIA
VOLTAGGIO/VOLTAGE/SPANNUNG/VOLTAGE/VOLTAJE

⚡ kW kcal/h
⚡ kW V~ Hz

PREZZO/PRICE €
PREIS/PRIX/PRECIO €
KG / M³

F18-94ETD
0915A430

FRIGGITRICE ELETTRICA ELETTRONICA con TouchScreen 7".
Conservazione a 110 °C o Prelavoro a 160 °C con o senza Melting.
Possibilità di inserire in memoria fino a 100 programmi. Sensore
presenza e livello massimo olio. Vasca 18 litri cm.31x34x33h - 2 cesti
cm.13,5x29x21h - Filtro e coperchio vasca. Bacinella raccolta olio con
supporto su ruote. Produzione patate: 27 kg/h (inclusa 1 testata chiusura
piano mod.TPA-9)

EN Electric electronic Fryer with a 7" TouchScreen. Conservation at
110 °C and preworking at 160 °C with or without Melting. Possibility
to store in the memory up to 100 programs. Oil presence sensor
and maximum level sensor. Bowl 18 lts cm.31x34x33h - 2 baskets
cm.13,5x29x21h. Sieve and lid for pan. Oil collection basin with support
on wheels. Production: 27 kg/h (included 1 Head end filler strip mod.
TPA-9) • **DE** ELEKTRONISCHE ELEKTRISCHE FRITEUSE mit TouchScreen
7". Aufbewahrung bei 110 °C oder Vorbearbeitung bei 160 °C mit
oder ohne Melting. Es können bis zu 100 Programme gespeichert
werden. Anwesenheits- sowie maximaler Ölstandsensoren. Becken 18 lt.
cm.31x34x33h - 2 Körbe cm.13,5x29x21h. Einlegesieb und Deckel
für Becken. Ölauffangbecken mit Halterung auf Rädern. Pommes frites:
27 kg/h (inbegriffen 1 Abschluss-Element mod.TPA-9) • **FR** FRITEUSE
ÉLECTRIQUE ÉLECTRONIQUE à Écran tactile 7". Conservation à 110 °C
ou Pré-traitement à 160 °C avec ou sans Melting. Possibilité d'enregistrer
jusqu'à 100 programmes en mémoire. Capteur de présence et de niveau
maximal huile. Cuve 18 lt. cm.31x34x33h - 2 Paniers cm.13,5x29x21h.
Filtre, couvercle pour cuve. Bassine de collecte de l'huile avec support sur
roues. Production de pommes frites: 27 kg/h (inclus 1 Élément de jonction
top mod.TPA-9) • **ES** FREIDORA ELÉCTRICA ELECTRÓNICA
**CON PANTALLA TÁCTIL DE 7". CONSERVACIÓN A 110 °C
O TRABAJO PREVIO A 160 °C CON O SIN FUSIÓN. SE
PUEDEN ALMACENAR HASTA 100 PROGRAMAS EN LA
MEMORIA. SENSOR DE PRESENCIA Y NIVEL MÁXIMO DE
ACEITE. CUBA DE 18 LITROS CM. 31X34X33H - 2 CESTAS
CM.13,5X29X21H. FILTRO Y TAPA PARA CUBA. CUBETA
DE RECOGIDA DE ACEITE CON SOPORTE SOBRE RUEDAS.
PROD. PATATAS: 27 KG/H (INCLUIDA 1 CHAPA DE CIERRE
PARA TOP MOD.TPA-9)**
cm. 40x 90x 90h



⚡ 15,95 kW **6.871,00**
400V~3N 69 / 0,54
50/60 Hz

FRIGGITRICI ELETTRICHE DIGITALI

MOD. _____
COD. _____

DESCRIZIONE/DESCRIPTION/BEZEICHNUNG/DESCRIPTION/DESCRIPCIÓN
DIMENSIONI/DIMENSIONS/ABMESSUNGEN/DIMENSIONS/DIMENSIONES

POTENZA/POWER/LEISTUNG/PUISSANCE/POTENCIA
VOLTAGGIO/VOLTAGE/SPANNUNG/VOLTAGE/VOLTAJE

⚡ kcal/h
kw
V~
Hz

PREZZO/PRICE €
PREIS/PRIX/PRECIO €
KG / M³

F18-94ETDP
0915A431

FRIGGITRICE ELETTRICA ELETTRONICA con TouchScreen 7".
Conservazione a 110 °C o Prelavoro a 160 °C con o senza Melting. Possibilità di inserire in memoria fino a 100 programmi. Sensore presenza e livello massimo olio. Pompa filtraggio olio a caldo max 180°C, pulizia vasca, svuotamento vasca. Vasca 18 litri cm.31x34x33h - 2 cesti cm.13,5x29x21h - Filtro e coperchio vasca. Bacinella raccolta olio con supporto su ruote e filtro 5 micron (pz.100 inclusi). Produzione patate: 27 kg/h (inclusa 1 testata chiusura piano mod.TPA-9)

EN Electric electronic Fryer with a 7" TouchScreen. Conservation at 110 °C and preworking at 160 °C with or without Melting. Possibility to store in the memory up to 100 programs. Oil presence sensor and maximum level sensor. Pump for filter the hot oil max 180°C, Tank cleaning, Tank emptying. Bowl 18 lts cm.31x34x33h - 2 baskets cm.13,5x29x21h. Sieve and lid for pan. Oil collection basin with support on wheels with sieve 5 microns (pcs.100 included). Production: 27 kg/h (included 1 Head end filler strip mod.TPA-9) • **DE** ELEKTRONISCHE ELEKTRISCHE FRITEUSE mit TouchScreen 7". Aufbewahrung bei 110 °C oder Vorbearbeitung bei 160 °C mit oder ohne Melting. Es können bis zu 100 Programme gespeichert werden. Anwesenheits- sowie maximaler Ölstandsensor. Heißölfilterpumpe max 180°C, Tankreinigung, Tankentleerung. Becken 18 lt. cm.31x34x33h - 2 Körbe cm.13,5x29x21h. Einlegesieb und Deckel für Becken. Ölauffangbecken mit Halterung auf Rädern und 5-Mikron-Filter (Stk.100 inbegriffen). Pommes frites: 27 kg/h (inbegriffen 1 Abschluss-Element mod.TPA-9) • **FR** FRITEUSE ÉLECTRIQUE ÉLECTRONIQUE à Écran tactile 7". Conservation à 110 °C ou Pré-traitement à 160 °C avec ou sans Melting. Possibilité d'enregistrer jusqu'à 100 programmes en mémoire. Capteur de présence et de niveau maximal huile. Pompe filtration huile à chaud max 180°C, nettoyage cuve, vidange cuve. Cuve 18 lt. cm.31x34x33h - 2 Paniers cm.13,5x29x21h. Filtre, couvercle pour cuve. Bassine de collecte de l'huile avec support sur roues et filtre 5 microns (pcs.100 inclus). Production de pommes frites: 27 kg/h (inclus 1 Élément de jonction top mod.TPA-9) • **ES** FREIDORA ELÉCTRICA ELECTRÓNICA CON PANTALLA TÁCTIL DE 7". CONSERVACIÓN A 110 °C O TRABAJO PREVIO A 160 °C CON O SIN FUSIÓN. SE PUEDEN ALMACENAR HASTA 100 PROGRAMAS EN LA MEMORIA. SENSOR DE PRESENCIA Y NIVEL MÁXIMO DE ACEITE. BOMBA DE FILTRADO DE ACEITE CALIENTE, MÁXIMO 180 °C, LIMPIEZA DEL TANQUE, VACIADO DEL TANQUE. CUBA DE 18 LITROS CM. 31X34X33H - 2 CESTAS CM.13,5X29X21H. FILTRO Y TAPA PARA CUBA. CUBETA DE RECOGIDA DE ACEITE CON SOPORTE SOBRE RUEDAS Y FILTRO DE 5 MICRONES (PZ.100 INCLUIDA). PROD. PATATAS: 27 KG/H (INCLUIDA 1 CHAPA DE CIERRE PARA TOP MOD.TPA-9)
cm. 40x 90x 90h



⚡ 16,2 kW **10.526,00**
400V~3N 79 / 0,54
50/60 Hz

FRIGGITRICI ELETTRICHE DIGITALI

MOD. _____
COD. _____

DESCRIZIONE/DESCRIPTION/BEZEICHNUNG/DESCRIPTION/DESCRIPCIÓN
DIMENSIONI/DIMENSIONS/ABMESSUNGEN/DIMENSIONS/DIMENSIONES

POTENZA/POWER/LEISTUNG/PUISSANCE/POTENCIA
VOLTAGGIO/VOLTAGE/SPANNUNG/VOLTAGE/VOLTAJE

⚡ kW _____
kcal/h _____
V~ _____
Hz _____

PREZZO/PRICE
PREIS/PRIX/PRECIO €
KG / M³

F18-94ETDPS
0915A432

FRIGGITRICE ELETTRICA ELETTRONICA con TouchScreen 7".
Conservazione a 110 °C o Prelavoro a 160 °C con o senza Melting.
Possibilità di inserire in memoria fino a 100 programmi. Sensore presenza e livello massimo olio. Pompa filtraggio olio a caldo max 180°C, pulizia vasca, svuotamento vasca. 2 sollevatori cesti integrati. Vasca 18 litri cm.31x34x33h - 2 cesti cm.13,5x29x21h - Filtro e coperchio vasca. Bacinella raccolta olio con supporto su ruote e filtro 5 micron (pz.100 inclusi). Produzione patate: 27 kg/h (inclusa 1 testata chiusura piano mod.TPA-9)

EN Electric electronic Fryer with a 7" TouchScreen. Conservation at 110 °C and preworking at 160 °C with or without Melting. Possibility to store in the memory up to 100 programs. Oil presence sensor and maximum level sensor. Pump for filter the hot oil max 180°C, Tankreinigung, Tank emptying. 2 Lifter for baskets integrated. Bowl 18 lts cm.31x34x33h - 2 baskets cm.13,5x29x21h. Sieve and lid for pan. Oil collection basin with support on wheels with sieve 5 microns (pcs.100 included). Production: 27 kg/h (included 1 Head end filler strip mod.TPA-9) • **DE** ELEKTRONISCHE ELEKTRISCHE FRITEUSE mit TouchScreen 7". Aufbewahrung bei 110 °C oder Vorbearbeitung bei 160 °C mit oder ohne Melting. Es können bis zu 100 Programme gespeichert werden. Anwesenheits- sowie maximaler Ölstandsensoren. Heißölfilterpumpe max 180°C, Tankreinigung, Tankentleerung. Integrierte 2 Korbheber. Becken 18 lt. cm.31x34x33h - 2 Körbe cm.13,5x29x21h. Einlegesieb und Deckel für Becken. Ölauffangbecken mit Halterung auf Rädern und 5-Mikron-Filter (Stk.100 inbegriffen). Pommes frites: 27 kg/h (inbegriffen 1 Abschluss-Element mod.TPA-9) • **FR** FRITEUSE ÉLECTRIQUE ÉLECTRONIQUE à Écran tactile 7". Conservation à 110 °C ou Pré-traitement à 160 °C avec ou sans Melting. Possibilité d'enregistrer jusqu'à 100 programmes en mémoire. Capteur de présence et de niveau maximal huile. Pompe filtration huile à chaud max 180°C, nettoyage cuve, vidange cuve. 2 Élévateurs paniers intégrés. Cuve 18 lt. cm.31x34x33h - 2 Paniers cm.13,5x29x21h. Filtre, couvercle pour cuve. Bassine de collecte de l'huile avec support sur roues et filtre 5 microns (pcs.100 inclus). Production de pommes frites: 27 kg/h (inclus 1 Élément de jonction top mod.TPA-9) • **ES** FREIDORA ELÉCTRICA ELECTRÓNICA CON PANTALLA TÁCTIL DE 7". CONSERVACIÓN A 110 °C O TRABAJO PREVIO A 160 °C CON O SIN FUSIÓN. SE PUEDEN ALMACENAR HASTA 100 PROGRAMAS EN LA MEMORIA. SENSOR DE PRESENCIA Y NIVEL MÁXIMO DE ACEITE. BOMBA DE FILTRADO DE ACEITE CALIENTE, MÁXIMO 180 °C, LIMPIEZA DEL TANQUE, VACIADO DEL TANQUE. 2 ELEVADORES DE CESTA INTEGRADOS. CUBA DE 18 LITROS CM. 31X34X33H - 2 CESTAS CM.13,5X29X21H. FILTRO Y TAPA PARA CUBA. CUBETA DE RECOGIDA DE ACEITE CON SOPORTE SOBRE RUEDAS Y FILTRO DE 5 MICRONES (PZ.100 INCLUIDA). PROD. PATATAS: 27 KG/H (INCLUIDA 1 CHAPA DE CIERRE PARA TOP MOD.TPA-9)
cm. 40x 90x 90h



⚡ 16,55 kW _____ **13.084,00**
400V~3N _____ 89 / 0,54
50/60 Hz

FRIGGITRICI ELETTRICHE DIGITALI

MOD. _____
COD. _____

DESCRIZIONE/DESCRIPTION/BEZEICHNUNG/DESCRIPTION/DESCRIPCIÓN
DIMENSIONI/DIMENSIONS/ABMESSUNGEN/DIMENSIONS/DIMENSIONES

POTENZA/POWER/LEISTUNG/PUISSANCE/POTENCIA
VOLTAGGIO/VOLTAGE/SPANNUNG/VOLTAGE/VOLTAJE

⚡ kW
kcal/h

⚡ kw
V~
Hz

PREZZO/PRICE €
PREIS/PRIX/PRECIO €
KG / M³

F2/18-98ETD
0915A830

FRIGGITRICE ELETTRICA ELETTRONICA con TouchScreen 7".
Conservazione a 110 °C o Prelavoro a 160 °C con o senza Melting.
Possibilità di inserire in memoria fino a 100 programmi. Sensore
presenza e livello massimo olio. 2 vasche 18 litri cm.31x34x33h - 4 cesti
cm.13,5x29x21h - Filtri e coperchi vasche. 2 bacinelle raccolta olio con
supporto su ruote. Produzione patate: 54 kg/h (inclusa 1 testata chiusura
piano mod.TPA-9)

EN Electric electronic Fryer with a 7" TouchScreen. Conservation at
110 °C and preworking at 160 °C with or without Melting. Possibility
to store in the memory up to 100 programs. Oil presence sensor and
maximum level sensor. 2 bowls 18 lts cm.31x34x33h - 4 baskets
cm.13,5x29x21h. 2 Sieve and lid for pan. 2 Oil collection basin with
support on wheels. Production: 54 kg/h (included 1 Head end filler
strip mod.TPA-9) • **DE** ELEKTRONISCHE ELEKTRISCHE FRITEUSE mit
TouchScreen 7". Aufbewahrung bei 110 °C oder Vorbearbeitung bei 160
°C mit oder ohne Melting. Es können bis zu 100 Programme gespeichert
werden. Anwesenheits- sowie maximaler Ölstandsensor. 2 Becken
18 lt. cm.31x34x33h - 4 Körbe cm.13,5x29x21h. 2 Einlegesieb und
Deckel für Becken. Ölauffangbecken mit Halterung auf Rädern. Pommes
frites: 54 kg/h (inbegriffen 1 Abschluss-Element mod.TPA-9) • **FR**
FRITEUSE ÉLECTRIQUE ÉLECTRONIQUE à Écran tactile 7". Conservation
à 110 °C ou Pré-traitement à 160 °C avec ou sans Melting. Possibilité
d'enregistrer jusqu'à 100 programmes en mémoire. Capteur de présence
et de niveau maximal huile. 2 Cuves 18 lt. cm.31x34x33h - 4 Paniers
cm.13,5x29x21h. 2 Filtre, couvercle pour cuve. 2 Bassine de collecte
de l'huile avec support sur roues. Production de pommes frites: 54
kg/h (inclus 1 Élément de jonction top mod.TPA-9) • **ES** FREIDORA
ELECTRICA ELECTRÓNICA CON PANTALLA TÁCTIL DE 7".
**CONSERVACIÓN A 110 °C O TRABAJO PREVIO A 160 °C
CON O SIN FUSIÓN. SE PUEDEN ALMACENAR HASTA 100
PROGRAMAS EN LA MEMORIA. SENSOR DE PRESENCIA
Y NIVEL MÁXIMO DE ACEITE. 2 CUBAS DE 18 LITROS CM.
31X34X33H - 4 CESTAS CM.13,5X29X21H. 2 FILTROS Y
TAPAS PARA CUBA. 2 CUBETAS DE RECOGIDA DE ACEITE
CON SOPORTE SOBRE RUEDAS. PROD. PATATAS: 54 KG/H
(INCLUIDA 1 CHAPA DE CIERRE PARA TOP MOD.TPA-9)
cm. 80x 90x 90h**



⚡ 31,9 kW **12.389,00**
400V~3N 118 / 1,05
50/60 Hz

FRIGGITRICI ELETTRICHE DIGITALI

MOD. _____
COD. _____

DESCRIZIONE/DESCRIPTION/BEZEICHNUNG/DESCRIPTION/DESCRIPCIÓN
DIMENSIONI/DIMENSIONS/ABMESSUNGEN/DIMENSIONS/DIMENSIONES

POTENZA/POWER/LEISTUNG/PUISSANCE/POTENCIA
VOLTAGGIO/VOLTAGE/SPANNUNG/VOLTAGE/VOLTAJE

⚡ kW kcal/h
V~ Hz

PREZZO/PRICE €
PREIS/PRIX/PRECIO €
KG / M³

F2/18-98ETDP
0915A831

FRIGGITRICE ELETTRICA ELETTRONICA con TouchScreen 7".
Conservazione a 110 °C o Prelavoro a 160 °C con o senza Melting.
Possibilità di inserire in memoria fino a 100 programmi. Sensore presenza e livello massimo olio. 2 pompe filtraggio olio a caldo max 180°C, pulizia vasca, svuotamento vasca. 2 vasche 18 litri cm.31x34x33h - 4 cesti cm.13,5x29x21h - Filtri e coperchi vasche. 2 bacinelle raccolta olio con supporto su ruote e filtro 5 micron (pz.100 inclusi). Produzione patate: 54 kg/h (inclusa 1 testata chiusura piano mod.TPA-9)

EN Electric electronic Fryer with a 7" TouchScreen. Conservation at 110 °C and preworking at 160 °C with or without Melting. Possibility to store in the memory up to 100 programs. Oil presence sensor and maximum level sensor. 2 Pump for filter the hot oil max 180°C, Tank cleaning, Tank emptying. 2 bowls 18 lts cm.31x34x33h - 4 baskets cm.13,5x29x21h. 2 Sieve and lid for pan. 2 Oil collection basin with support on wheels with sieve 5 microns (pcs.100 included). Production: 54 kg/h (included 1 Head end filler strip mod.TPA-9) • **DE** ELEKTRONISCHE ELEKTRISCHE FRITEUSE mit TouchScreen 7". Aufbewahrung bei 110 °C oder Vorbearbeitung bei 160 °C mit oder ohne Melting. Es können bis zu 100 Programme gespeichert werden. Anwesenheits- sowie maximaler Ölstandsensor. 2 Heißölfilterpumpe max 180°C, Tankreinigung, Tankentleerung. 2 Becken 18 lt. cm.31x34x33h - 4 Körbe cm.13,5x29x21h. 2 Einlegesieb und Deckel für Becken. 2 Ölauffangbecken mit Halterung auf Rädern und 5-Mikron-Filter (Stk.100 inbegriffen). Pommes frites: 54 kg/h (inbegriffen 1 Abschluss-Element mod.TPA-9) • **FR** FRITEUSE ÉLECTRIQUE ÉLECTRONIQUE à Écran tactile 7". Conservation à 110 °C ou Pré-traitement à 160 °C avec ou sans Melting. Possibilité d'enregistrer jusqu'à 100 programmes en mémoire. Capteur de présence et de niveau maximal huile. 2 Pompe filtration huile à chaud max 180°C, nettoyage cuve, vidange cuve. 2 Cuves 18 lt. cm.31x34x33h - 4 Paniers cm.13,5x29x21h. 2 Filtre, couvercle pour cuve. 2 Bassine de collecte de l'huile avec support sur roues et filtre 5 microns (pcs.100 inclus). Production de pommes frites: 54 kg/h (inclus 1 Élément de jonction top mod.TPA-9) • **ES** FREIDORA ELÉCTRICA ELECTRÓNICA CON PANTALLA TÁCTIL DE 7". CONSERVACIÓN A 110 °C O TRABAJO PREVIO A 160 °C CON O SIN FUSIÓN. SE PUEDEN ALMACENAR HASTA 100 PROGRAMAS EN LA MEMORIA. SENSOR DE PRESENCIA Y NIVEL MÁXIMO DE ACEITE. 2 BOMBA DE FILTRADO DE ACEITE CALIENTE, MÁXIMO 180 °C, LIMPIEZA DEL TANQUE, VACIADO DEL TANQUE. 2 CUBAS DE 18 LITROS CM. 31X34X33H - 4 CESTAS CM.13,5X29X21H. 2 FILTROS Y TAPAS PARA CUBA. 2 CUBETAS DE RECOGIDA DE ACEITE CON SOPORTE SOBRE RUEDAS Y FILTRO DE 5 MICRONES (PZ.100 INCLUIDA). PROD. PATATAS: 54 KG/H (INCLUIDA 1 CHAPA DE CIERRE PARA TOP MOD.TPA-9)
cm. 80x 90x 90h



⚡ 32,4 kW **19.698,00**
400V~3N 138 / 1,05
50/60 Hz

FRIGGITRICI ELETTRICHE DIGITALI

MOD. COD.	DESCRIZIONE/DESCRIPTION/BEZEICHNUNG/DESCRIPTION/DESCRIPCIÓN DIMENSIONI/DIMENSIONS/ABMESSUNGEN/DIMENSIONS/DIMENSIONES	POTENZA/POWER/LEISTUNG/PUISSANCE/POTENCIA VOLTAGGIO/VOLTAGE/SPANNUNG/VOLTAGE/VOLTAJE	⚡ kW kcal/h	⚡ kW V~ Hz	PREZZO/PRICE € PREIS/PRIX/PRECIO € KG / M³
--------------	---	---	----------------	------------------	--

F2/18-98ETDPS
0915A832

FRIGGITRICE ELETTRICA ELETTRONICA con TouchScreen 7".
Conservazione a 110 °C o Prelavoro a 160 °C con o senza Melting.
Possibilità di inserire in memoria fino a 100 programmi. Sensore presenza e livello massimo olio. 2 pompe filtraggio olio a caldo max 180°C, pulizia vasca, svuotamento vasca. 4 sollevatori cesti integrati. 2 vasche 18 litri cm.31x34x33h - 4 cesti cm.13,5x29x21h - Filtri e coperchi vasche. 2 bacinelle raccolta olio con supporto su ruote e filtro 5 micron (pz.100 inclusi). Produzione patate: 54 kg/h (inclusa 1 testata chiusura piano mod.TPA-9)

EN Electric electronic Fryer with a 7" TouchScreen. Conservation at 110 °C and preworking at 160 °C with or without Melting. Possibility to store in the memory up to 100 programs. Oil presence sensor and maximum level sensor. 2 Pump for filter the hot oil max 180°C, Tank cleaning, Tank emptying. 4 Lifter for baskets integrated. 2 bowls 18 lts cm.31x34x33h - 4 baskets cm.13,5x29x21h. 2 Sieve and lid for pan. 2 Oil collection basin with support on wheels with sieve 5 microns (pcs.100 included). Production: 54 kg/h (included 1 Head end filler strip mod.TPA-9) • **DE** ELEKTRONISCHE ELEKTRISCHE FRITEUSE mit TouchScreen 7". Aufbewahrung bei 110 °C oder Vorbearbeitung bei 160 °C mit oder ohne Melting. Es können bis zu 100 Programme gespeichert werden. Anwesenheits- sowie maximaler Ölstandsensor. 2 Heißölfilterpumpe max 180°C, Tankreinigung, Tankentleerung. Integrierte 4 Korbheber. 2 Becken 18 lt. cm.31x34x33h - 4 Körbe cm.13,5x29x21h. 2 Einlegesieb und Deckel für Becken. 2 Ölauffangbecken mit Halterung auf Rädern und 5-Mikron-Filter (Stk.100 inbegriffen). Pommes frites: 54 kg/h (inbegriffen 1 Abschluss-Element mod.TPA-9) • **FR** FRITEUSE ÉLECTRIQUE ÉLECTRONIQUE à Écran tactile 7". Conservation à 110 °C ou Pré-traitement à 160 °C avec ou sans Melting. Possibilité d'enregistrer jusqu'à 100 programmes en mémoire. Capteur de présence et de niveau maximal huile. 2 Pompe filtration huile à chaud max 180°C, nettoyage cuve, vidange cuve. 4 Élévateurs paniers intégrés. 2 Cuve 18 lt. cm.31x34x33h - 4 Paniers cm.13,5x29x21h. 2 Filtre, couvercle pour cuve. 2 Bassine de collecte de l'huile avec support sur roues et filtre 5 microns (pcs.100 inclus). Production de pommes frites: 54 kg/h (inclus 1 Élément de jonction top mod.TPA-9) • **ES** FREIDORA ELÉCTRICA ELECTRÓNICA CON PANTALLA TÁCTIL DE 7". CONSERVACIÓN A 110 °C O TRABAJO PREVIO A 160 °C CON O SIN FUSIÓN. SE PUEDEN ALMACENAR HASTA 100 PROGRAMAS EN LA MEMORIA. SENSOR DE PRESENCIA Y NIVEL MÁXIMO DE ACEITE. 2 BOMBA DE FILTRADO DE ACEITE CALIENTE, MÁXIMO 180 °C, LIMPIEZA DEL TANQUE, VACIADO DEL TANQUE. 4 ELEVADORES DE CESTA INTEGRADOS. 2 CUBAS DE 18 LITROS CM. 31X34X33H - 4 CESTAS CM.13,5X29X21H. 2 FILTROS Y TAPAS PARA CUBA. 2 CUBETAS DE RECOGIDA DE ACEITE CON SOPORTE SOBRE RUEDAS Y FILTRO DE 5 MICRONES (PZ.100 INCLUIDA). PROD. PATATAS: 54 KG/H (INCLUIDA 1 CHAPA DE CIERRE PARA TOP MOD.TPA-9)
cm. 80x 90x 90h



⚡ 33,1 kW **24.814,00**
400V~3N 158 / 1,05
50/60 Hz

FRIGGITRICI ELETTRICHE DIGITALI

MOD. _____
COD. _____

DESCRIZIONE/DESCRIPTION/BEZEICHNUNG/DESCRIPTION/DESCRIPCIÓN
DIMENSIONI/DIMENSIONS/ABMESSUNGEN/DIMENSIONS/DIMENSIONES

POTENZA/POWER/LEISTUNG/PUISSANCE/POTENCIA
VOLTAGGIO/VOLTAGE/SPANNUNG/VOLTAGE/VOLTAJE

⚡ kW _____
kcal/h _____
V~ _____
Hz _____

PREZZO/PRICE _____ €
PREIS/PRIX/PRECIO _____ €
KG / M³

F25-94ETD
0915B430

FRIGGITRICE ELETTRICA ELETTRONICA con TouchScreen 7".
Conservazione a 110 °C o Prelavoro a 160 °C con o senza Melting.
Possibilità di inserire in memoria fino a 100 programmi. Sensore
presenza e livello massimo olio. Vasca 25 litri cm.31x51x33h - 2 cesti
cm.13,5x45x21h - Filtro e coperchio vasca. Bacinella raccolta olio con
supporto su ruote. Produzione patate: 35 Kg/h (inclusa 1 testata chiusura
piano mod.TPA-9)

EN Electric electronic Fryer with a 7" TouchScreen. Conservation at
110 °C and preworking at 160 °C with or without Melting. Possibility
to store in the memory up to 100 programs. Oil presence sensor
and maximum level sensor. Bowl 25 lts cm.31x51x33h - 2 baskets
cm.13,5x45x21h. Sieve and lid for pan. Oil collection basin with support
on wheels. Production: 35 Kg/h (included 1 Head end filler strip mod.
TPA-9) • **DE** ELEKTRONISCHE ELEKTRISCHE FRITEUSE mit TouchScreen
7". Aufbewahrung bei 110 °C oder Vorbearbeitung bei 160 °C mit
oder ohne Melting. Es können bis zu 100 Programme gespeichert
werden. Anwesenheits- sowie maximaler Ölstandsensoren. Becken 25 lt.
cm.31x51x33h - 2 Körbe cm.13,5x45x21h. Einlegesieb und Deckel
für Becken. Ölauffangbecken mit Halterung auf Rädern. Pommes frites:
35 kg/h (inbegriffen 1 Abschluss-Element mod.TPA-9) • **FR** FRITEUSE
ÉLECTRIQUE ÉLECTRONIQUE à Écran tactile 7". Conservation à 110 °C
ou Pré-traitement à 160 °C avec ou sans Melting. Possibilité d'enregistrer
jusqu'à 100 programmes en mémoire. Capteur de présence et de niveau
maximal huile. Cuve 25 lt. cm.31x51x33h - 2 Paniers cm.13,5x45x21h.
Filtre, couvercle pour cuve. Bassine de collecte de l'huile avec support sur
roues. Production de pommes frites: 35 kg/h (inclus 1 Élément de jonction
top mod.TPA-9) • **ES** FREIDORA ELÉCTRICA ELECTRÓNICA
**CON PANTALLA TÁCTIL DE 7". CONSERVACIÓN A 110 °C
O TRABAJO PREVIO A 160 °C CON O SIN FUSIÓN. SE
PUEDEN ALMACENAR HASTA 100 PROGRAMAS EN LA
MEMORIA. SENSOR DE PRESENCIA Y NIVEL MÁXIMO DE
ACEITE. CUBA DE 25 LITROS CM. 31X51X33H - 2 CESTAS
CM.13,5X45X21H. FILTRO Y TAPA PARA CUBA. CUBETA
DE RECOGIDA DE ACEITE CON SOPORTE SOBRE RUEDAS.
PROD. PATATAS: 35 KG/H (INCLUIDA 1 CHAPA DE CIERRE
PARA TOP MOD.TPA-9)
cm. 40x 90x 90h**



⚡ **22,05 kW**
400V~3N
50/60 Hz

7.142,00
72 / 0,54

FRIGGITRICI ELETTRICHE DIGITALI

MOD. _____
COD. _____

DESCRIZIONE/DESCRIPTION/BEZEICHNUNG/DESCRIPTION/DESCRIPCIÓN
DIMENSIONI/DIMENSIONS/ABMESSUNGEN/DIMENSIONS/DIMENSIONES

POTENZA/POWER/LEISTUNG/PUISSANCE/POTENCIA
VOLTAGGIO/VOLTAGE/SPANNUNG/VOLTAGE/VOLTAJE

$\frac{kW}{kcal/h}$ $\frac{kW}{V\sim}$
Hz

PREZZO/PRICE €
PREIS/PRIX/PRECIO €
KG / M³

F25-94ETDP
0915B431

FRIGGITRICE ELETTRICA ELETTRONICA con TouchScreen 7".
Conservazione a 110 °C o Prelavoro a 160 °C con o senza Melting.
Possibilità di inserire in memoria fino a 100 programmi. Sensore presenza e livello massimo olio. Pompa filtraggio olio a caldo max 180°C, pulizia vasca, svuotamento vasca. Vasca 25 litri cm.31x51x33h - 2 cesti cm.13,5x45x21h - Filtro e coperchio vasca. Bacinella raccolta olio con supporto su ruote e filtro 5 micron (pz.100 inclusi). Produzione patate: 35 Kg/h (inclusa 1 testata chiusura piano mod.TPA-9)

EN Electric electronic Fryer with a 7" TouchScreen. Conservation at 110 °C and preworking at 160 °C with or without Melting. Possibility to store in the memory up to 100 programs. Oil presence sensor and maximum level sensor. Pump for filter the hot oil max 180°C, Tank cleaning, Tank emptying. Bowl 25 lts cm.31x51x33h - 2 baskets cm.13,5x45x21h. Sieve and lid for pan. Oil collection basin with support on wheels with sieve 5 microns (pcs.100 included). Production: 35 Kg/h (included 1 Head end filler strip mod.TPA-9) • **DE** ELEKTRONISCHE ELEKTRISCHE FRITEUSE mit TouchScreen 7". Aufbewahrung bei 110 °C oder Vorbearbeitung bei 160 °C mit oder ohne Melting. Es können bis zu 100 Programme gespeichert werden. Anwesenheits- sowie maximaler Ölstandsensor. Heißölfilterpumpe max 180°C, Tankreinigung, Tankentleerung. Becken 25 lt. cm.31x51x33h - 2 Körbe cm.13,5x45x21h. Einlegesieb und Deckel für Becken. Ölauffangbecken mit Halterung auf Rädern und 5-Mikron-Filter (Stk.100 inbegriffen). Pommes frites: 35 kg/h (inbegriffen 1 Abschluss-Element mod.TPA-9) • **FR** FRITEUSE ÉLECTRIQUE ÉLECTRONIQUE à Écran tactile 7". Conservation à 110 °C ou Pré-traitement à 160 °C avec ou sans Melting. Possibilité d'enregistrer jusqu'à 100 programmes en mémoire. Capteur de présence et de niveau maximal huile. Pompe filtration huile à chaud max 180°C, nettoyage cuve, vidange cuve. Cuve 25 lt. cm.31x51x33h - 2 Paniers cm.13,5x45x21h. Filtre, couvercle pour cuve. Bassine de collecte de l'huile avec support sur roues et filtre 5 microns (pcs.100 inclus). Production de pommes frites: 35 kg/h (inclus 1 Élément de jonction top mod.TPA-9) • **ES** FREIDORA ELÉCTRICA ELECTRÓNICA CON PANTALLA TÁCTIL DE 7".

CONSERVACIÓN A 110 °C O TRABAJO PREVIO A 160 °C CON O SIN FUSIÓN. SE PUEDEN ALMACENAR HASTA 100 PROGRAMAS EN LA MEMORIA. SENSOR DE PRESENCIA Y NIVEL MÁXIMO DE ACEITE. BOMBA DE FILTRADO DE ACEITE CALIENTE, MÁXIMO 180 °C, LIMPIEZA DEL TANQUE, VACIADO DEL TANQUE. CUBA DE 25 LITROS CM. 31X51X33H - 2 CESTAS CM.13,5X45X21H. FILTRO Y TAPA PARA CUBA. CUBETA DE RECOGIDA DE ACEITE CON SOPORTE SOBRE RUEDAS Y FILTRO DE 5 MICRONES (PZ.100 INCLUIDA). PROD. PATATAS: 35 KG/H (INCLUIDA 1 CHAPA DE CIERRE PARA TOP MOD.TPA-9)
cm. 40x 90x 90h



⚡ 22,3 kW **10.796,00**
400V~3N 82 / 0,54
50/60 Hz

FRIGGITRICI ELETTRICHE DIGITALI

MOD. _____
COD. _____

DESCRIZIONE/DESCRIPTION/BEZEICHNUNG/DESCRIPTION/DESCRIPCIÓN
DIMENSIONI/DIMENSIONS/ABMESSUNGEN/DIMENSIONS/DIMENSIONES

POTENZA/POWER/LEISTUNG/PUISSANCE/POTENCIA
VOLTAGGIO/VOLTAGE/SPANNUNG/VOLTAGE/VOLTAJE

⚡ kW _____
kcal/h _____
V~ _____
Hz _____

PREZZO/PRICE
PREIS/PRIX/PRECIO €
KG / M³

F25-94ETDPS
0915B432

FRIGGITRICE ELETTRICA ELETTRONICA con TouchScreen 7".
Conservazione a 110 °C o Prelavoro a 160 °C con o senza Melting.
Possibilità di inserire in memoria fino a 100 programmi. Sensore presenza
e livello massimo olio. Pompa filtraggio olio a caldo max 180°C, pulizia
vasca, svuotamento vasca. Sollevatori cesti integrati. Vasca 25 litri
cm.31x51x33h - 2 cesti cm.13,5x45x21h - Filtro e coperchio vasca.
Bacinella raccolta olio con supporto su ruote e filtro 5 micron (pz.100
inclusi). Produzione patate: 35 Kg/h (inclusa 1 testata chiusura piano
mod.TPA-9)

EN Electric electronic Fryer with a 7" TouchScreen. Conservation at 110
°C and preworking at 160 °C with or without Melting. Possibility to store
in the memory up to 100 programs. Oil presence sensor and maximum
level sensor. Pump for filter the hot oil max 180°C, Tankreinigung,
Tankentleerung. Integrierte 2 Korbheber. Becken 25 lt. cm.31x51x33h - 2
baskets cm.13,5x45x21h. Sieve and lid for pan. Oil collection basin with
support on wheels with sieve 5 microns (pcs.100 included). Production: 35
Kg/h (included 1 Head end filler strip mod.TPA-9) • **DE** ELEKTRONISCHE
ELEKTRISCHE FRITEUSE mit TouchScreen 7". Aufbewahrung bei 110
°C oder Vorbearbeitung bei 160 °C mit oder ohne Melting. Es können
bis zu 100 Programme gespeichert werden. Anwesenheits- sowie
maximaler Ölstandsensoren. Heißölfilterpumpe max 180°C, Tankreinigung,
Tankentleerung. Integrierte 2 Korbheber. Becken 25 lt. cm.31x51x33h
- 2 Körbe cm.13,5x45x21h. Einlegesieb und Deckel für Becken.
Ölauffangbecken mit Halterung auf Rädern und 5-Mikron-Filter (Stk.100
inbegriffen). Pommes frites: 35 kg/h (inbegriffen 1 Abschluss-Element
mod.TPA-9) • **FR** FRITEUSE ÉLECTRIQUE ÉLECTRONIQUE à Écran tactile
7". Conservation à 110 °C ou Pré-traitement à 160 °C avec ou sans
Melting. Possibilité d'enregistrer jusqu'à 100 programmes en mémoire.
Capteur de présence et de niveau maximal huile. Pompe filtration huile à
chaud max 180°C, nettoyage cuve, vidange cuve. 2 Élévateurs paniers
intégrés. Cuve 25 lt. cm.31x51x33h - 2 Paniers cm.13,5x45x21h. Filtre,
couverture pour cuve. Bassine de collecte de l'huile avec support sur roues
et filtre 5 microns (pcs.100 inclus). Production de pommes frites: 35
kg/h (inclus 1 Élément de jonction top mod.TPA-9) • **ES** FREIDORA
ELECTRICA ELECTRÓNICA CON PANTALLA TÁCTIL DE 7".
**CONSERVACIÓN A 110 °C O TRABAJO PREVIO A 160 °C
CON O SIN FUSIÓN. SE PUEDEN ALMACENAR HASTA 100
PROGRAMAS EN LA MEMORIA. SENSOR DE PRESENCIA
Y NIVEL MÁXIMO DE ACEITE. BOMBA DE FILTRADO
DE ACEITE CALIENTE, MÁXIMO 180 °C, LIMPIEZA DEL
TANQUE, VACIADO DEL TANQUE. 2 ELEVADORES DE CESTA
INTEGRADOS. CUBA DE 25 LITROS CM. 31X51X33H - 2
CESTAS CM.13,5X45X21H. FILTRO Y TAPA PARA CUBA.
CUBETA DE RECOGIDA DE ACEITE CON SOPORTE SOBRE
RUEDAS Y FILTRO DE 5 MICRONES (PZ.100 INCLUIDA).
PROD. PATATAS: 35 KG/H (INCLUIDA 1 CHAPA DE CIERRE
PARA TOP MOD.TPA-9)
cm. 40x 90x 90h**



⚡ 22,65 kW _____ **13.354,00**
400V~3N _____ 92 / 0,54
50/60 Hz

FRIGGITRICI ELETTRICHE DIGITALI

MOD. _____
COD. _____

DESCRIZIONE/DESCRIPTION/BEZEICHNUNG/DESCRIPTION/DESCRIPCIÓN
DIMENSIONI/DIMENSIONS/ABMESSUNGEN/DIMENSIONS/DIMENSIONES

POTENZA/POWER/LEISTUNG/PUISSANCE/POTENCIA
VOLTAGGIO/VOLTAGE/SPANNUNG/VOLTAGE/VOLTAJE

⚡ kW
kcal/h

⚡ kW
V~
Hz

PREZZO/PRICE €
PREIS/PRIX/PRECIO €
KG / M³

F2/25-98ETD
0915B830

FRIGGITRICE ELETTRICA ELETTRONICA con TouchScreen 7".
Conservazione a 110 °C o Prelavoro a 160 °C con o senza Melting.
Possibilità di inserire in memoria fino a 100 programmi. Sensore presenza e livello massimo olio. 2 vasche 25 litri cm.31x51x33h - 4 cesti cm.13,5x45x21h - Filtri e coperchi vasche. 2 bacinelle raccolta olio con supporto su ruote. Produzione patate: 70 kg/h (inclusa 1 testata chiusura piano mod.TPA-9)

EN Electric electronic Fryer with a 7" TouchScreen. Conservation at 110 °C and preworking at 160 °C with or without Melting. Possibility to store in the memory up to 100 programs. Oil presence sensor and maximum level sensor. 2 bowl 25 lts cm.31x51x33h - 4 baskets cm.13,5x45x21h. 2 Sieve and lid for pan. 2 Oil collection basin with support on wheels. Production: 70 kg/h (included 1 Head end filler strip mod.TPA-9) • **DE** ELEKTRONISCHE ELEKTRISCHE FRITEUSE mit TouchScreen 7". Aufbewahrung bei 110 °C oder Vorbearbeitung bei 160 °C mit oder ohne Melting. Es können bis zu 100 Programme gespeichert werden. Anwesenheits- sowie maximaler Ölstandsensor. 2 Becken 25 lt. cm.31x51x33h - 4 Körbe cm.13,5x45x21h. 2 Einlegesieb und Deckel für Becken. Ölauffangbecken mit Halterung auf Rädern. Pommes frites: 70 kg/h (inbegriffen 1 Abschluss-Element mod.TPA-9) • **FR** FRITEUSE ÉLECTRIQUE ÉLECTRONIQUE à Écran tactile 7". Conservation à 110 °C ou Pré-traitement à 160 °C avec ou sans Melting. Possibilité d'enregistrer jusqu'à 100 programmes en mémoire. Capteur de présence et de niveau maximal huile. 2 Cuves 25 lt. cm.31x51x33h - 4 Paniers cm.13,5x45x21h. 2 Filtre, couvercle pour cuve. 2 Bassine de collecte de l'huile avec support sur roues. Production de pommes frites: 70 kg/h (inclus 1 Élément de jonction top mod.TPA-9) • **ES** FREIDORA ELÉCTRICA ELECTRÓNICA CON PANTALLA TÁCTIL DE 7". CONSERVACIÓN A 110 °C O TRABAJO PREVIO A 160 °C CON O SIN FUSIÓN. SE PUEDEN ALMACENAR HASTA 100 PROGRAMAS EN LA MEMORIA. SENSOR DE PRESENCIA Y NIVEL MÁXIMO DE ACEITE. 2 CUBAS DE 25 LITROS CM. 31X51X33H - 4 CESTAS CM.13,5X45X21H. 2 FILTROS Y TAPAS PARA CUBA. 2 CUBETAS DE RECOGIDA DE ACEITE CON SOPORTE SOBRE RUEDAS. PROD. PATATAS: 70 KG/H (INCLUIDA 1 CHAPA DE CIERRE PARA TOP MOD.TPA-9) cm. 80x 90x 90h



⚡ 44,1 kW **12.931,00**
400V~3N 126 / 1,05
50/60 Hz

FRIGGITRICI ELETTRICHE DIGITALI

MOD. _____
COD. _____

DESCRIZIONE/DESCRIPTION/BEZEICHNUNG/DESCRIPTION/DESCRIPCIÓN
DIMENSIONI/DIMENSIONS/ABMESSUNGEN/DIMENSIONS/DIMENSIONES

POTENZA/POWER/LEISTUNG/PUISSANCE/POTENCIA
VOLTAGGIO/VOLTAGE/SPANNUNG/VOLTAGE/VOLTAJE

⚡ kW _____
kcal/h _____
V~ _____
Hz _____

PREZZO/PRICE € _____
PREIS/PRIX/PRECIO € _____
KG / M³ _____

F2/25-98ETDP
0915B831

FRIGGITRICE ELETTRICA ELETTRONICA con TouchScreen 7".
Conservazione a 110 °C o Prelavoro a 160 °C con o senza Melting.
Possibilità di inserire in memoria fino a 100 programmi. Sensore presenza e livello massimo olio. 2 pompe filtraggio olio a caldo max 180°C, pulizia vasca, svuotamento vasca. 2 vasche 25 litri cm.31x51x33h - 4 cesti cm.13,5x45x21h - Filtri e coperchi vasche. 2 bacinelle raccolta olio con supporto su ruote e filtro 5 micron (pz.100 inclusi). Produzione patate: 70 kg/h (inclusa 1 testata chiusura piano mod.TPA-9)

EN Electric electronic Fryer with a 7" TouchScreen. Conservation at 110 °C and preworking at 160 °C with or without Melting. Possibility to store in the memory up to 100 programs. Oil presence sensor and maximum level sensor. 2 pump for filter the hot oil max 180°C, Tank cleaning, Tank emptying. 2 bowl 25 lts cm.31x51x33h - 4 baskets cm.13,5x45x21h. 2 Sieve and lid for pan. 2 Oil collection basin with support on wheels with sieve 5 microns (pcs.100 included). Production: 70 kg/h (included 1 Head end filler strip mod.TPA-9) • **DE** ELEKTRONISCHE ELEKTRISCHE FRITEUSE mit TouchScreen 7". Aufbewahrung bei 110 °C oder Vorbearbeitung bei 160 °C mit oder ohne Melting. Es können bis zu 100 Programme gespeichert werden. Anwesenheits- sowie maximaler Ölstandsensor. 2 Heißölfilterpumpe max 180°C, Tankreinigung, Tankentleerung. 2 Becken 25 lt. cm.31x51x33h - 4 Körbe cm.13,5x45x21h. 2 Einlegesieb und Deckel für Becken. 2 Ölauffangbecken mit Halterung auf Rädern und 5-Mikron-Filter (Stk.100 inbegriffen). Pommes frites: 70 kg/h (inbegriffen 1 Abschluss-Element mod.TPA-9) • **FR** FRITEUSE ÉLECTRIQUE ÉLECTRONIQUE à Écran tactile 7". Conservation à 110 °C ou Pré-traitement à 160 °C avec ou sans Melting. Possibilité d'enregistrer jusqu'à 100 programmes en mémoire. Capteur de présence et de niveau maximal huile. 2 Pompe filtration huile à chaud max 180°C, nettoyage cuve, vidange cuve. 2 Cuves 25 lt. cm.31x51x33h - 4 Paniers cm.13,5x45x21h. 2 Filtre, couvercle pour cuve. 2 Bassine de collecte de l'huile avec support sur roues et filtre 5 microns (pcs.100 inclus). Production de pommes frites: 70 kg/h (inclus 1 Élément de jonction top mod.TPA-9) • **ES** FREIDORA ELÉCTRICA ELECTRÓNICA CON PANTALLA TÁCTIL DE 7". CONSERVACIÓN A 110 °C O TRABAJO PREVIO A 160 °C CON O SIN FUSIÓN. SE PUEDEN ALMACENAR HASTA 100 PROGRAMAS EN LA MEMORIA. SENSOR DE PRESENCIA Y NIVEL MÁXIMO DE ACEITE. 2 BOMBA DE FILTRADO DE ACEITE CALIENTE, MÁXIMO 180 °C, LIMPIEZA DEL TANQUE, VACIADO DEL TANQUE. 2 CUBAS DE 25 LITROS CM. 31X51X33H - 4 CESTAS CM.13,5X45X21H. 2 FILTROS Y TAPAS PARA CUBA. 2 CUBETAS DE RECOGIDA DE ACEITE CON SOPORTE SOBRE RUEDAS Y FILTRO DE 5 MICRONES (PZ.100 INCLUIDA). PROD. PATATAS: 70 KG/H (INCLUIDA 1 CHAPA DE CIERRE PARA TOP MOD.TPA-9)

cm. 80x 90x 90h



⚡ 44,6 kW **20.239,00**
400V~3N 146 / 1,05
50/60 Hz

FRIGGITRICI ELETTRICHE DIGITALI

MOD. _____
COD. _____

DESCRIZIONE/DESCRIPTION/BEZEICHNUNG/DESCRIPTION/DESCRIPCIÓN
DIMENSIONI/DIMENSIONS/ABMESSUNGEN/DIMENSIONS/DIMENSIONES

POTENZA/POWER/LEISTUNG/PUISSANCE/POTENCIA
VOLTAGGIO/VOLTAGE/SPANNUNG/VOLTAGE/VOLTAJE

⚡ kW kcal/h
⚡ kW V~ Hz

PREZZO/PRICE €
PREIS/PRIX/PRECIO
KG / M³

F2/25-98ETDPS FRIGGITRICE ELETTRICA ELETTRONICA con TouchScreen 7".
0915B832 Conservazione a 110 °C o Prelavoro a 160 °C con o senza Melting. Possibilità di inserire in memoria fino a 100 programmi. Sensore presenza e livello massimo olio. 2 pompe filtraggio olio a caldo max 180°C, pulizia vasca, svuotamento vasca. 4 sollevatori cesti integrati. 2 vasche 25 litri cm.31x51x33h - 4 cesti cm.13,5x45x21h - Filtri e coperchi vasche. 2 bacinelle raccolta olio con supporto su ruote e filtro 5 micron (pz.100 inclusi). Produzione patate: 70 kg/h (inclusa 1 testata chiusura piano mod.TPA-9)

EN Electric electronic Fryer with a 7" TouchScreen. Conservation at 110 °C and preworking at 160 °C with or without Melting. Possibility to store in the memory up to 100 programs. Oil presence sensor and maximum level sensor. 2 pump for filter the hot oil max 180°C, Tank cleaning, Tank emptying. 4 Lifter for baskets integrated. 2 bowl 25 lts cm.31x51x33h - 4 baskets cm.13,5x45x21h. 2 Sieve and lid for pan. 2 Oil collection basin with support on wheels with sieve 5 microns (pcs.100 included). Production: 70 kg/h (included 1 Head end filler strip mod.TPA-9) • **DE** ELEKTRONISCHE ELEKTRISCHE FRITEUSE mit TouchScreen 7". Aufbewahrung bei 110 °C oder Vorbearbeitung bei 160 °C mit oder ohne Melting. Es können bis zu 100 Programme gespeichert werden. Anwesenheits- sowie maximaler Ölstandsensor. 2 Heißölfilterpumpe max 180°C, Tankreinigung, Tankentleerung. Integrierte 4 Korbheber. 2 Becken 25 Lt. cm.31x51x33h - 4 Körbe cm.13,5x45x21h. 2 Einlegesieb und Deckel für Becken. 2 Ölauffangbecken mit Halterung auf Rädern und 5-Mikron-Filter (Stk.100 inbegriffen). Pommes frites: 70 kg/h (inbegriffen 1 Abschluss-Element mod.TPA-9) • **FR** FRITEUSE ÉLECTRIQUE ÉLECTRONIQUE à Écran tactile 7". Conservation à 110 °C ou Pré-traitement à 160 °C avec ou sans Melting. Possibilité d'enregistrer jusqu'à 100 programmes en mémoire. Capteur de présence et de niveau maximal huile. 2 Pompe filtration huile à chaud max 180°C, nettoyage cuve, vidange cuve. 4 Élévateurs paniers intégrés. 2 Cuve 25 Lt. cm.31x51x33h - 4 Paniers cm.13,5x45x21h. 2 Filtre, couvercle pour cuve. 2 Bassine de collecte de l'huile avec support sur roues et filtre 5 microns (pcs.100 inclus). Production de pommes frites: 70 kg/h (inclus 1 Élément de jonction top mod.TPA-9) • **ES** FREIDORA ELÉCTRICA ELECTRÓNICA CON PANTALLA TÁCTIL DE 7". CONSERVACIÓN A 110 °C O TRABAJO PREVIO A 160 °C CON O SIN FUSIÓN. SE PUEDEN ALMACENAR HASTA 100 PROGRAMAS EN LA MEMORIA. SENSOR DE PRESENCIA Y NIVEL MÁXIMO DE ACEITE. 2 BOMBA DE FILTRADO DE ACEITE CALIENTE, MÁXIMO 180 °C, LIMPIEZA DEL TANQUE, VACIADO DEL TANQUE. 4 ELEVADORES DE CESTA INTEGRADOS. 2 CUBAS DE 25 LITROS CM. 31X51X33H - 4 CESTAS CM.13,5X45X21H. 2 FILTROS Y TAPAS PARA CUBA. 2 CUBETAS DE RECOGIDA DE ACEITE CON SOPORTE SOBRE RUEDAS Y FILTRO DE 5 MICRONES (PZ.100 INCLUIDA). PROD. PATATAS: 70 KG/H (INCLUIDA 1 CHAPA DE CIERRE PARA TOP MOD.TPA-9)
cm. 80x 90x 90h



⚡ 45,3 kW **25.355,00**
400V~3N 166 / 1,05
50/60 Hz

BR80-98ETF/I BRASIERA a ribaltamento manuale, Vasca 80 litri cm.72x56x22,5h, fondo inox con coperchio
09070835

EN Braising pan with manual tilting, bowl 80 lt. cm.72x56x22,5h, Stainless steel bottom with lid • **DE** Kippbratpfanne mit manual Kippung, 80 Lt. cm.72x56x22,5h, boden aus crnst. mit deckel • **FR** Sauteuse avec basculement manuel, cuve 80 lt. cm.72x56x22,5h, fond inox avec couvercle • **ES** SARTÉN CON LEVANTAMIENTO MANUAL, CUBA 80 LT. CM.72X56X22,5H, FONDO DE ACERO INOX CON TAPA
cm. 80x 90x 90h



⚡ 12 kW **7.460,00**
400V~3N 156 / 0,89
50/60 Hz

BRM80-98ETF/I BRASIERA a ribaltamento automatico, Vasca 80 litri cm.72x56x22,5h, fondo inox con coperchio
09070836

EN Braising pan with automatic tilting, bowl 80 lt. cm.72x56x22,5h, Stainless steel bottom with lid • **DE** Kippbratpfanne mit automatisch Kippung, 80 Lt. cm.72x56x22,5h, boden aus crnst. mit deckel • **FR** Sauteuse avec basculement automatique, cuve 80 lt. cm.72x56x22,5h, fond inox avec couvercle • **ES** SARTÉN CON LEVANTAMIENTO AUTOMÁTICO, CUBA 80 LT. CM.72X56X22,5H, FONDO DE ACERO INOX CON TAPA
cm. 80x 90x 90h



⚡ 12,1 kW **9.111,00**
400V~3N 162 / 0,89
50 Hz

BRASIERE RIBALTABILI A GAS

MOD. _____
COD. _____

DESCRIZIONE/DESCRIPTION/BEZEICHNUNG/DESCRIPTION/DESCRIPCIÓN
DIMENSIONI/DIMENSIONS/ABMESSUNGEN/DIMENSIONS/DIMENSIONES

POTENZA/POWER/LEISTUNG/PUISSANCE/POTENCIA
VOLTAGGIO/VOLTAGE/SPANNUNG/VOLTAGE/VOLTAGE

⚡ kW _____
kcal/h _____
V~ _____
Hz _____

PREZZO/PRICE €
PREIS/PRIX/PRECIO _____
KG / M³

BR80-98GF/I BRASIERA a ribaltamento manuale, Vasca 80 litri cm.72x56x22,5h, fondo
09240855 inox con coperchio

EN Braising pan with manual tilting, bowl 80 lt. cm.72x56x22,5h, Stainless steel bottom with lid • **DE** Kippbratpfanne mit manual Kippung, 80 Lt. cm.72x56x22,5h, boden aus crnst. mit deckel • **FR** Sauteuse avec basculement manuel, cuve 80 lt. cm.72x56x22,5h, fond inox avec couvercle • **ES SARTÉN CON LEVANTAMIENTO MANUAL, CUBA 80 LT. CM.72X56X22,5H, FONDO DE ACERO INOX CON TAPA**
cm. 80x 90x 90h



⚡ 22 kW _____ **7.406,00**
18.920 kcal/h 159 / 0,89

BRM80-98GF/I BRASIERA a ribaltamento automatico, Vasca 80 litri cm.72x56x22,5h,
09240856 fondo inox con coperchio

EN Braising pan with automatic tilting, bowl 80 lt. cm.72x56x22,5h, Stainless steel bottom with lid • **DE** Kippbratpfanne mit automatisch Kippung, 80 Lt. cm.72x56x22,5h, boden aus crnst. mit deckel • **FR** Sauteuse avec basculement automatique, cuve 80 lt. cm.72x56x22,5h, fond inox avec couvercle • **ES SARTÉN CON LEVANTAMIENTO AUTOMATICO, CUBA 80 LT. CM.72X56X22,5H, FONDO DE ACERO INOX CON TAPA**
cm. 80x 90x 90h



⚡ 22 kW _____ **9.290,00**
18.920 kcal/h 165 / 0,89

⚡ 0,1KW _____
230V~ _____
50 Hz _____

BRF-94ET BRASIERA FISSA MULTIFUNZIONALE ELETTRICA Vasca cm. 30x68x10h
09070433 (inclusa 1 testata chiusura piano mod.TPA-9)

EN Electric multi-function fixed braising pan Bowl cm. 30x68x10h (included 1 Head end filler strip mod.TPA-9) • **DE** Elektrische Multifunktionsbratpfanne fest Becken cm. 30x68x10h (inbegriffen 1 Abschluss-Element mod.TPA-9) • **FR** Sauteuse fixe multifonction électrique Cuve cm. 30x68x10h (inclus 1 Élément de jonction top mod.TPA-9) • **ES SARTEN FIJA MULTIFUNCIÓN ELÉCTRICA CUBA CM. 30X68X10H (INCLUIDA 1 CHAPA DE CIERRE PARA TOP MOD.TPA-9)**
cm. 40x 90x 90h



⚡ 5,2 kW _____ **4.210,00**
400V~2N _____ 79 / 0,46
50/60 Hz _____

BRF-98ET BRASIERA FISSA MULTIFUNZIONALE ELETTRICA Vasca cm. 70x68x10h
09070833 (inclusa 1 testata chiusura piano mod.TPA-9)

EN Electric multi-function fixed braising pan - Bowl cm. 70x68x10h (included 1 Head end filler strip mod.TPA-9) • **DE** Elektrische Multifunktionsbratpfanne fest - Becken cm. 70x68x10h (inbegriffen 1 Abschluss-Element mod.TPA-9) • **FR** Sauteuse fixe multifonction électrique - Cuve cm. 70x68x10h (inclus 1 Élément de jonction top mod.TPA-9) • **ES SARTEN FIJA MULTIFUNCIÓN ELÉCTRICA - CUBA CM. 70X68X10H (INCLUIDA 1 CHAPA DE CIERRE PARA TOP MOD.TPA-9)**
cm. 80x 90x 90h



⚡ 10,4 kW _____ **6.083,00**
400V~3N _____ 126 / 0,89
50/60 Hz _____

BRF-94G BRASIERA FISSA MULTIFUNZIONALE GAS Vasca cm. 30x68x10h (inclusa
09240453 1 testata chiusura piano mod.TPA-9)

EN Gas multi-function fixed braising pan - Bowl cm. 30x68x10h (included 1 Head end filler strip mod.TPA-9) • **DE** Gas-Multifunktionsbratpfanne fest - Becken cm. 30x68x10h (inbegriffen 1 Abschluss-Element mod.TPA-9) • **FR** Sauteuse fixe multifonction à gaz - Cuve cm. 30x68x10h (inclus 1 Élément de jonction top mod.TPA-9) • **ES SARTEN FIJA MULTIFUNCIÓN A GAS - CUBA CM. 30X68X10H (INCLUIDA 1 CHAPA DE CIERRE PARA TOP MOD.TPA-9)**
cm. 40x 90x 90h



⚡ 9 kW _____ **4.994,00**
7.740 kcal/h _____ 79 / 0,46

BRF-98G BRASIERA FISSA MULTIFUNZIONALE GAS Vasca cm. 70x68x10h (inclusa
09240853 1 testata chiusura piano mod.TPA-9)

EN Gas multi-function fixed braising pan - Bowl cm. 70x68x10h (included 1 Head end filler strip mod.TPA-9) • **DE** Gas-Multifunktionsbratpfanne fest - Becken cm. 70x68x10h (inbegriffen 1 Abschluss-Element mod.TPA-9) • **FR** Sauteuse fixe multifonction à gaz - Cuve cm. 70x68x10h (inclus 1 Élément de jonction top mod.TPA-9) • **ES SARTEN FIJA MULTIFUNCIÓN A GAS - CUBA CM. 70X68X10H (INCLUIDA 1 CHAPA DE CIERRE PARA TOP MOD.TPA-9)**
cm. 80x 90x 90h



⚡ 18 kW _____ **7.131,00**
15.480 kcal/h _____ 129 / 0,89

BRASIERE RIBALTABILI ELETTRICHE

MOD. _____ DESCRIZIONE/DESCRIPTION/BEZEICHNUNG/DESCRIPTION/DESCRIPCIÓN POTENZA/POWER/LEISTUNG/PUISSANCE/POTENCIA kW kcal/h PREZZO/PRICE €
 COD. _____ DIMENSIONI/DIMENSIONS/ABMESSUNGEN/DIMENSIONS/DIMENSIONES VOLTAGGIO/VOLTAGE/SPANNUNG/VOLTAGE/VOLTAJE V~ Hz PREIS/PRIX/PRECIO €
 KG / M³

BR120-912ETF/I BRASIERA a ribaltamento manuale, Vasca 120 litri cm.110x56x22,5h, fondo inox con coperchio
 09071235 **EN** Braising pan with manual tilting, bowl 120 lt. cm.110x56x22,5h, Stainless steel bottom with lid • **DE** Kippbratpfanne mit manual Kippung, 120 Lt. cm.110x56x22,5h, boden aus crnst. mit deckel • **FR** Sauteuse avec basculement manuel, cuve 120 lt. cm.110x56x22,5h, fond inox avec couvercle • **ES SARTÉN CON LEVANTAMIENTO MANUAL, CUBA 120 LT. CM.110X56X22,5H, FONDO DE ACERO INOX CON TAPA**
cm. 120x 90x 90h



⚡ 18 kW **10.862,00**
 400V~3N 205 / 1,32
 50/60 Hz

BRM120-912ETF/I BRASIERA a ribaltamento automatico, Vasca 120 litri cm.110x56x22,5h, fondo inox con coperchio
 09071236 **EN** Braising pan with automatic tilting, bowl 120 lt. cm.110x56x22,5h, Stainless steel bottom with lid • **DE** Kippbratpfanne mit automatisch Kippung, 120 Lt. cm.110x56x22,5h, boden aus crnst. mit deckel • **FR** Sauteuse avec basculement automatique, cuve 120 lt. cm.110x56x22,5h, fond inox avec couvercle • **ES SARTÉN CON LEVANTAMIENTO AUTOMATICO, CUBA 120 LT. CM.110X56X22,5H, FONDO DE ACERO INOX CON TAPA**
cm. 120x 90x 90h



⚡ 18,1 kW **12.499,00**
 400V~3N 211 / 1,32
 50 Hz

BR120-912GF/I BRASIERA a ribaltamento manuale, Vasca 120 litri cm.110x56x22,5h, fondo inox con coperchio
 09241255 **EN** Braising pan with manual tilting, bowl 120 lt. cm.110x56x22,5h, Stainless steel bottom with lid • **DE** Kippbratpfanne mit manual Kippung, 120 Lt. cm.110x56x22,5h, boden aus crnst. mit deckel • **FR** Sauteuse avec basculement manuel, cuve 120 lt. cm.110x56x22,5h, fond inox avec couvercle • **ES SARTÉN CON LEVANTAMIENTO MANUAL, CUBA 120 LT. CM.110X56X22,5H, FONDO DE ACERO INOX CON TAPA**
cm. 120x 90x 90h



⚡ 30 kW **10.892,00**
 25.800 kcal/h 208 / 1,32

BRM120-912GF/I BRASIERA a ribaltamento automatico, Vasca 120 litri cm.110x56x22,5h, fondo inox con coperchio
 09241256 **EN** Braising pan with automatic tilting, bowl 120 lt. cm.110x56x22,5h, Stainless steel bottom with lid • **DE** Kippbratpfanne mit automatisch Kippung, 120 Lt. cm.110x56x22,5h, boden aus crnst. mit deckel • **FR** Sauteuse avec basculement automatique, cuve 120 lt. cm.110x56x22,5h, fond inox avec couvercle • **ES SARTÉN CON LEVANTAMIENTO AUTOMATICO, CUBA 120 LT. CM.110X56X22,5H, FONDO DE ACERO INOX CON TAPA**
cm. 120x 90x 90h



⚡ 30 KW **12.981,00**
 25.800 kcal/h 214 / 1,32

⚡ 0,1KW
 230V~
 50 Hz

PL-92 PIANO LAVORO SU MOBILE (inclusa 1 testata chiusura piano mod.TPA-9)
 09010200 **EN** Worktop on cabinet (included 1 Head end filler strip mod.TPA-9) • **DE** Arbeitsplatte mit Unterbau (inbegriffen 1 Abschluss-Element mod. TPA-9) • **FR** Plan de travail sur armoire (inclus 1 Élément de jonction top mod.TPA-9) • **ES SOBRE DE TRABAJO SOBRE MUEBLE (INCLUIDA 1 CHAPA DE CIERRE PARA TOP MOD.TPA-9)**
cm. 20x 90x 90h



1.116,00
 45 / 0,46

PLS-93 PIANO LAVORO SU MOBILE A GIORNO (inclusa 1 testata chiusura piano mod.TPA-9)
 09010301 **EN** Worktop on open cabinet (included 1 Head end filler strip mod.TPA-9) • **DE** Arbeitsplatte mit offenem Unterbau (inbegriffen 1 Abschluss-Element mod.TPA-9) • **FR** Plan de travail sur armoire ouvert (inclus 1 Élément de jonction top mod.TPA-9) • **ES SOBRE DE TRABAJO SOBRE MUEBLE ABIERTO (INCLUIDA 1 CHAPA DE CIERRE PARA TOP MOD.TPA-9)**
cm. 30x 90x 90h



1.138,00
 47 / 0,46

PIANI LAVORO

MOD. _____ DESCRIZIONE/DESCRIPTION/BEZEICHNUNG/DESCRIPTION/DESCRIPCIÓN POTENZA/POWER/LEISTUNG/PUISSANCE/POTENCIA ⚡kW ⚡kw PREZZO/PRICE €
 COD. _____ DIMENSIONI/DIMENSIONS/ABMESSUNGEN/DIMENSIONS/DIMENSIONES VOLTAGGIO/VOLTAGE/SPANNUNG/VOLTAGE/VOLTAJE kcal/h V~ Hz PREIS/PRIX/PRECIO €
 KG / M³

PLS-94 cm. 40x 90x 90h
 09010401



1.156,00
 49 / 0,46

PLS-96 cm. 60x 90x 90h
 09010601



1.718,00
 59 / 0,68

PLS-98 cm. 80x 90x 90h
 09010801



1.824,00
 70 / 0,89

PL-93 PIANO LAVORO SU MOBILE A GIORNO Cassetto cm. 19x50x15h inox
 09010300 (inclusa 1 testata chiusura piano mod.TPA-9)
EN Worktop on open cabinet Drawer cm. 19x50x15h (included 1 Head end filler strip mod.TPA-9) • **DE** Arbeitsplatte mit offenem Unterbau. Schublade cm. 19x50x15h (inbegriffen 1 Abschluss-Element mod.TPA-9) • **FR** Plan de travail sur armoire ouvert. Tiroir inox cm. 19x50x15h (inclus 1 Elément de jonction top mod.TPA-9) • **ES SOBRE DE TRABAJO CON MUEBLE ABIERTO. CAJÓN CM. 19X50X15H INOX (INCLUIDA 1 CHAPA DE CIERRE PARA TOP MOD. TPA-9)**
 cm. 30x 90x 90h



1.444,00
 50 / 0,46

PL-94 PIANO LAVORO SU MOBILE A GIORNO Cassetto con 1 bacinella GN
 09010400 1/1 15h in plastica (inclusa 1 testata chiusura piano mod.TPA-9)
EN Worktop on open cabinet Drawer with 1 plastic container GN 1/1 15h (included 1 Head end filler strip mod.TPA-9) • **DE** Arbeitsplatte mit offenem Unterbau Schublade mit 1 GN 1/1 15h Kunststoffbehälter (inbegriffen 1 Abschluss-Element mod.TPA-9) • **FR** Plan de travail sur armoire ouvert Tiroir avec bac en plastique GN 1/1 15h (inclus 1 Elément de jonction top mod.TPA-9) • **ES SOBRE DE TRABAJO SOBRE MUEBLE ABIERTO CAJÓN CON 1 CONTENEDOR GN 1/1 15H PLÁSTICO (INCLUIDA 1 CHAPA DE CIERRE PARA TOP MOD.TPA-9)**
 cm. 40x 90x 90h



1.414,00
 54 / 0,46

PL-96 PIANO LAVORO SU MOBILE A GIORNO Cassetto cm. 49x50x15h inox
 09010600 (inclusa 1 testata chiusura piano mod.TPA-9)
EN Worktop on open cabinet Drawer cm. 49x50x15h (included 1 Head end filler strip mod.TPA-9) • **DE** Arbeitsplatte mit offenem Unterbau. Schublade cm. 49x50x15h (inbegriffen 1 Abschluss-Element mod.TPA-9) • **FR** Plan de travail sur armoire ouvert. Tiroir inox cm. 49x50x15h (inclus 1 Elément de jonction top mod.TPA-9) • **ES SOBRE DE TRABAJO CON MUEBLE ABIERTO. CAJÓN CM. 49X50X15H INOX (INCLUIDA 1 CHAPA DE CIERRE PARA TOP MOD. TPA-9)**
 cm. 60x 90x 90h



2.003,00
 70 / 0,68

PIANI LAVORO

MOD. _____ DESCRIZIONE/DESCRIPTION/BEZEICHNUNG/DESCRIPTION/DESCRIPCIÓN POTENZA/POWER/LEISTUNG/PUISSANCE/POTENCIA kW kcal/h PREZZO/PRICE €
 COD. _____ DIMENSIONI/DIMENSIONS/ABMESSUNGEN/DIMENSIONES/DIMENSIONES VOLTAGGIO/VOLTAGE/SPANNUNG/VOLTAGE/VOLTAGE V~ Hz PREIS/PRIX/PRECIO €
 KG / M³

PL-98
09010800
PIANO LAVORO SU MOBILE A GIORNO Cassetto con 2 bacinelle GN 1/1 15h in plastica (inclusa 1 testata chiusura piano mod.TPA-9)
EN Worktop on open cabinet Drawer with 2 plastic containers GN 1/1 15h (included 1 Head end filler strip mod.TPA-9) • **DE** Arbeitsplatte mit offenem Unterbau Schublade mit 2 GN 1/1 15h Kunststoffbehälter (inbegriffen 1 Abschluss-Element mod.TPA-9) • **FR** Plan de travail sur armoire ouvert tiroir avec 2 bacs en plastique GN 1/1 15h (inclus 1 Élément de jonction top mod.TPA-9) • **ES SOBRE DE TRABAJO SOBRE MUEBLE ABIERTO CAJÓN CON 2 CONTENEDORES GN 1/1 15H PLÁSTICO (INCLUIDA 1 CHAPA DE CIERRE PARA TOP MOD.TPA-9)**
cm. 80x 90x 90h



2.138,00
82 / 0,89

LA-94
09020400
LAVELLO SU MOBILE A GIORNO Rubinetto a leva - Vasca cm. 30x35x15h (inclusa 1 testata chiusura piano mod.TPA-9)
EN Sink unit on open cabinet - Lever type tap. Bowl cm. 30x35x15h (included 1 Head end filler strip mod.TPA-9) • **DE** Spülbecken Einhebel-Mischbatterie mit offenem Unterbau - Becken cm. 30x35x15h (inbegriffen 1 Abschluss-Element mod.TPA-9) • **FR** Bac-évier sur armoire ouvert avec robinetterie - Bac cm. 30x35x15h (inclus 1 Élément de jonction top mod.TPA-9) • **ES FREGADERO SOBRE MUEBLE ABIERTO - GRIFO A PALANCA - PILETA CM. 30X35X15H (INCLUIDA 1 CHAPA DE CIERRE PARA TOP MOD.TPA-9)**
cm. 40x 90x 90h



1.675,00
53 / 0,46

P-73/93-DX PORTA 300 DESTRA
08430300 **EN** Right door 300 • **DE** Rechte tür 300 • **FR** Porte droite 300 • **ES PUERTA DERECHA 300**
cm. 29,5x 2,5x 47,5h



213,00
3 / 0,01

P-74/94-DX PORTA 400 DESTRA
08430400 **EN** Right door 400 • **DE** Rechte tür 400 • **FR** Porte droite 400 • **ES PUERTA DERECHA 400**
cm. 39,5x 2,5x 47,5h



220,00
3.5 / 0,02

P-73/93-SX PORTA 300 SINISTRA
08430301 **EN** Left door 300 • **DE** Linke tür 300 • **FR** Porte gauche 300 • **ES PUERTA IZQUIERDA 300**
cm. 29,5x 2,5x 47,5h



213,00
3 / 0,01

P-74/94-SX PORTA 400 SINISTRA
08430401 **EN** Left door 400 • **DE** Linke tür 400 • **FR** Porte gauche 400 • **ES PUERTA IZQUIERDA 400**
cm. 39,5x 2,5x 47,5h

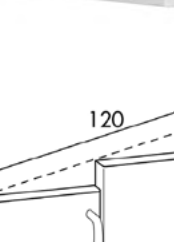

220,00
3.5 / 0,02

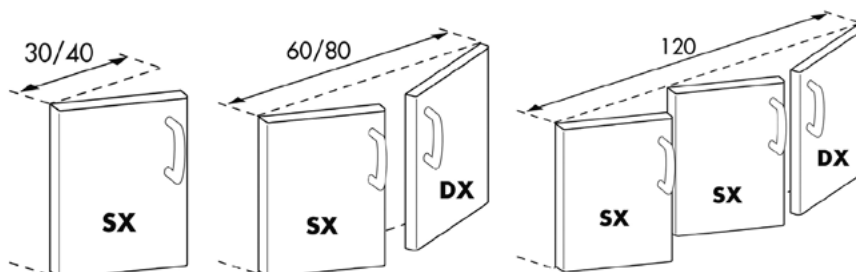

ACCESSORI

MOD. COD.	DESCRIZIONE/DESCRIPTION/BEZEICHNUNG/DESCRIPTION/DESCRIPCIÓN DIMENSIONI/DIMENSIONS/ABMESSUNGEN/DIMENSIONS/DIMENSIONES	POTENZA/POWER/LEISTUNG/PUISSANCE/POTENCIA VOLTAGGIO/VOLTAGE/SPANNUNG/VOLTAGE/VOLTAJE	kw kcal/h	kw V~ Hz	PREZZO/PRICE PREIS/PRIX/PRECIO € KG / M³
C-73/93 08440320	CASSETTIERA 300 N. 2 cassetti con 2 bacinelle inox, guide telescopiche. Solo su PL EN Drawer set 300 N. 2 drawers with 2 inox containers, telescopic guides. Only for PL • DE Schubladen 300 - N. 2 Schubladen mit 2 Chromnickelstahlbehältern, Telescopeinführungen. Nur für PL • FR Tiroirs pour meuble de 300 N. 2 tiroirs avec 2 bacs inox, guides télescopiques. Seulement pour PL • ES CAJONERA 300 - N. 2 CAJONES CON 2 CONTENEDORES DE ACERO INOX, GUÍAS TELESCÓPICAS. SOLO PARA PL cm. 29,5x 59x 47,5h				827,00 16 / 0,19
C-74/94 08440420	CASSETTIERA 400 - N. 2 cassetti con 2 bacinelle GN 1/1 15h in plastica, guide telescopiche. Solo su PL EN Drawer set 400 - N. 2 drawers with 2 GN 1/1 15h plastic containers, telescopic guides. Only for PL • DE Schubladen - N. 2 Schubladen mit 2 GN 1/1 15h Kunststoffbehältern, Telescopeinführungen. Nur für PL • FR Tiroirs pour meuble de 400 - N. 2 tiroirs avec 2 bacs en plastique GN 1/1 15h, guides télescopiques. Seulement pour PL • ES CAJONERA 400 - N. 2 CAJONES CON 2 CONTENEDORES GN 1/1 15H DE PLÁSTICO, GUÍAS TELESCÓPICAS. SOLO PARA PL cm. 39,5x 59x 47,5h				849,00 18 / 0,19
C-76/96 08440620	CASSETTIERA 600 N. 2 cassetti con 2 bacinelle inox, guide telescopiche. Solo su PL EN Drawer set 600 N. 2 drawers with 2 inox containers, telescopic guides. Only for PL • DE Schubladen 600 - N. 2 Schubladen mit 2 Chromnickelstahlbehältern, Telescopeinführungen. Nur für PL • FR Tiroirs pour meuble de 600 N. 2 tiroirs avec 2 bacs inox, guides télescopiques. Seulement pour PL • ES CAJONERA 600 - N. 2 CAJONES CON 2 CONTENEDORES DE ACERO INOX, GUÍAS TELESCÓPICAS. SOLO PARA PL cm. 59,5x 59x 47,5h				1.173,00 22 / 0,28
C-78/98 08440820	CASSETTIERA 800 - N. 2 cassetti con 4 bacinelle GN 1/1 15h in plastica, guide telescopiche. Solo su PL EN Drawer set 800 - N. 2 drawers with 4 GN 1/1 15h plastic containers, telescopic guides. Only for PL • DE Schubladen 800 - N. 2 Schubladen mit 4 GN 1/1 15h Kunststoffbehältern, Telescopeinführungen. Nur für PL • FR Tiroirs pour meuble de 800 - N. 2 tiroirs avec 4 bacs en plastique GN 1/1 15h, guides télescopiques. Seulement pour PL • ES CAJONERA 800 - N. 2 CAJONES CON 4 CONTENEDORES GN 1/1 15H DE PLÁSTICO, GUÍAS TELESCÓPICAS. SOLO PARA PL cm. 79,5x 59x 47,5h				1.193,00 26 / 0,37
D-9 09470000	DIVISORIO EN Spacer • DE Trennwand • FR Separation • ES DIVISORIO cm. 5x 79x 45h				235,00 2,5 / 0,03
531070300	CESTO 1/1 PER CP-94/98 & CPB-98 EN Basket 1/1 for CP-94/98 & CPB-98 • DE Korb 1/1 für CP-94/98 & CPB-98 • FR Panier 1/1 pour CP-94/98 & CPB-98 • ES CESTA 1/1 PARA CP-94/98 & CPB-98 cm. 28x 49x 21,5h				268,00 3,5 / 0,08

ACCESSORI CUOCIPASTA

MOD. _____ DESCRIZIONE/DESCRIPTION/BEZEICHNUNG/DESCRIPTION/DESCRIPCIÓN POTENZA/POWER/LEISTUNG/PUISSANCE/POTENCIA kW kcal/h $\frac{kW}{V}$ $\frac{Hz}{-$ PREZZO/PRICE € PREIS/PRIX/PRECIO € KG / M³
 COD. _____ DIMENSIONI/DIMENSIONS/ABMESSUNGEN/DIMENSIONS/DIMENSIONES VOLTAGGIO/VOLTAGE/SPANNUNG/VOLTAGE/VOLTAJE

531070200 CESTO 2/3 PER CP-94/98 & CPB-98
EN Basket 2/3 for CP-94/98 & CPB-98 • **DE** Korb 2/3 für CP-94/98 & CPB-98 • **FR** Panier 2/3 pour CP-94/98 & CPB-98 • **ES CESTA 2/3 PARA CP-94/98 & CPB-98**
 cm. 28x 32x 21,5h



185,00
2 / 0,06

531070100 CESTO 1/2 PER CP-94/98 & CPB-98
EN Basket 1/2 for CP-94/98 & CPB-98 • **DE** Korb 1/2 für CP-94/98 & CPB-98 • **FR** Panier 1/2 pour CP-94/98 & CPB-98 • **ES CESTA 1/2 PARA CP-94/98 & CPB-98**
 cm. 28x 24x 21,5h



167,00
1 / 0,05

531047900 CESTO 1/3 PER CP-94/98 & CPB-98
EN Basket 1/3 for CP-94/98 & CPB-98 • **DE** Korb 1/3 für CP-94/98 & CPB-98 • **FR** Panier 1/3 pour CP-94/98 & CPB-98 • **ES CESTA 1/3 PARA CP-94/98 & CPB-98**
 cm. 28x 16x 21,5h



133,00
1.5 / 0,04

531048000 CESTO 1/6 PER CP-94/98 & CPB-98
EN Basket 1/6 for CP-94/98 & CPB-98 • **DE** Korb 1/6 für CP-94/98 & CPB-98 • **FR** Panier 1/6 pour CP-94/98 & CPB-98 • **ES CESTA 1/6 PARA CP-94/98 & CPB-98**
 cm. 13,5x 16x 21,5h



102,00
1 / 0,02

CBTEST "CB TEST CERTIFICATE" per apparecchi: FT**-94/98ET**, PC/PCT/PCQ/PCQT-94/98/912/916ET, CF4/CFQ4-98ET, CF6/CQ6-912ET/ETV, CF8/CQ8-912ET/ETV, F18/25-94ET, F2/18-98ET, F2/25-98ET
EN "CB TEST CERTIFICATE" for model: FT**-94/98ET**, PC/PCT/PCQ/PCQT-94/98/912/916ET, CF4/CFQ4-98ET, CF6/CQ6-912ET/ETV, CF8/CQ8-912ET/ETV, F18/25-94ET, F2/18-98ET, F2/25-98ET • **DE** "CB TEST CERTIFICATE" für modell: FT**-94/98ET**, PC/PCT/PCQ/PCQT-94/98/912/916ET, CF4/CFQ4-98ET, CF6/CQ6-912ET/ETV, CF8/CQ8-912ET/ETV, F18/25-94ET, F2/18-98ET, F2/25-98ET • **FR** "CB TEST CERTIFICATE" pour modèle: FT**-94/98ET**, PC/PCT/PCQ/PCQT-94/98/912/916ET, CF4/CFQ4-98ET, CF6/CQ6-912ET/ETV, CF8/CQ8-912ET/ETV, F18/25-94ET, F2/18-98ET, F2/25-98ET • **ES** "CB TEST CERTIFICATE" PARA MODELO: FT**-94/98ET**, PC/PCT/PCQ/PCQT-94/98/912/916ET, CF4/CFQ4-98ET, CF6/CQ6-912ET/ETV, CF8/CQ8-912ET/ETV, F18/25-94ET, F2/18-98ET, F2/25-98ET



201,00
/

ACCESSORI

MOD. COD.	DESCRIZIONE/DESCRIPTION/BEZEICHNUNG/DESCRIPTION/DESCRIPCIÓN DIMENSIONI/DIMENSIONS/ABMESSUNGEN/DIMENSIONS/DIMENSIONES	POTENZA/POWER/LEISTUNG/PUISSANCE/POTENCIA VOLTAGGIO/VOLTAGE/SPANNUNG/VOLTAGE/VOLTAJE	⚡ kW kcal/h	⚡ kw V~ Hz	PREZZO/PRICE € PREIS/PRIX/PRECIO € KG / M³
CEA 09580010	COLONNINA EROGAZIONE ACQUA EN Pillar tap • DE Mischbatterie • FR Colonne de distribution eau • ES RUBINETO DISPENSADOR DE AGUA				459,00 6 / 0,05
CEAT 19580010	COLONNINA EROGAZIONE ACQUA TOP EN Pillar tap top • DE Mischbatterie top • FR Colonne de distribution eau top • ES RUBINETO DISPENSADOR DE AGUA TOP				459,00 5 / 0,04
531047100	GRIGLIA IN TONDINO 2 FUOCHI (serie 90) EN grid rod 2 burner (90 line) • DE Gitterstab 2 Brenner (90. Serie) • FR tige grille 2 feux (serie 90) • ES RED DE VARILLA 2 QUEMADOR (SERIE 90)				231,00 9 / 0,03
09570401	GRIGLIA TONDINO per CW (SERIE 90) EN Grid for CW (90 line) • DE Gitter für CW (90. Serie) • FR Grille ronde pour CW (serie 90) • ES REJILLA PARA CW (SERIE 90) cm. 36x 68				605,00 12 / 0,03
09570402	GRIGLIA TEGOLO V per CW (SERIE 90) EN Grid V for CW (90 line) • DE Gitter V für CW (90. Serie) • FR Grille V pour CW (serie 90) • ES REJILLA V PARA CW (SERIE 90) cm. 36x 68				605,00 12 / 0,03
544023800	RASCHIETTO PER PIASTRA RIGATA EN Scraper for grooved plate • DE Schaber für gerillte Kochplatte • FR Racloir pour plaque nervurée • ES RASQUETA PARA PLACA RANURADA				69,00 / 1,00
531040800	RASCHIETTO PER PIASTRA LISCIA AL CROMO LUCIDO EN Scraper for smooth POLISHED CHROME plate • DE Schaber für glatte POLIERTEM CHROM Platte • FR Racloir pour plaque lisse au CHROME POLI • ES RASQUETA PARA PLACA LISA DE CROMO PULIDO				63,00 / 1,00
531040900	KIT 10 LAME PER RASCHIETTO cod.531040800 EN 10 blades kit for scraper cod.531040800 • DE Kit 10 klingen für Schaber cod.531040800 • FR Kit de 10 lames pour racloir cod.531040800 • ES KIT DE 10 CUCHILLAS PARA RASQUETA COD.531040800				45,00 / 0,00

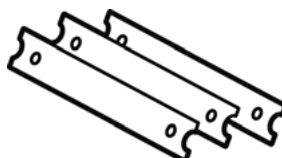
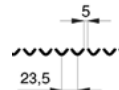
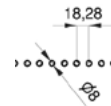
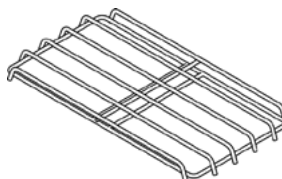

ACCESSORI FRY-TOP

MOD. COD.	DESCRIZIONE/DESCRIPTION/BEZEICHNUNG/DESCRIPTION/DESCRIPCIÓN DIMENSIONI/DIMENSIONS/ABMESSUNGEN/DIMENSIONS/DIMENSIONES	POTENZA/POWER/LEISTUNG/PUISSANCE/POTENCIA VOLTAGGIO/VOLTAGE/SPANNUNG/VOLTAGE/VOLTAGE	$\frac{kW}{kcal/h}$ $\frac{kw}{V-}$ Hz	PREZZO/PRICE € KG / M ³
T-FT 09580060	TAPPO PER FRY-TOP EN stopper for Fry-top • DE Stopfen griddleplatte • FR bouchon pour Plaque • ES TAPÓN FRY-TOP cm. 10x 2x 5h			268,00 / 0,00
PFT-94 09620400	KIT PROTEZIONE FRONTALE PIANO FRY-TOP EN KIT front protection plan fry-top • DE Schutz-kit vorne Plan griddleplatte • FR KIT protection avant plan plaque • ES KIT DE PROTECCIÓN FRONTAL PLAN DE FRY-TOP cm. 35x 11x 6h			181,00 / 0,00
PFT-98 09620800	cm. 75x 11x 6h			301,00 / 0,01
KF-F-ETD S90 546003502	KIT 100 filtri 5 micron per F-ETDP S90 EN KIT 100 sieve 5 microns for F-ETDP S90 • DE KIT 100 Filter 5-Mikron für F-ETDP S90 • FR KIT 100 filtre 5 microns pour F-ETDP S90 • ES KIT 100 FILTRO DE 5 MICRONES PARA F-ETDP S90			433,00 0.1 / 0,00
531041600	CESTINO 1/2 per F18-E (standard in F18-ETD) EN Basket 1/2 for F18-E (standard F18-ETD) • DE Korb 1/2 zur Friteuse F18-E (standard F18-ETD) • FR Panier 1/2 pour F18-E (standard F18-ETD) • ES CESTA 1/2 PARA F18-E (STANDARD F18-ETD) cm. 13,5x 29x 15h			84,00 0.8 / 0,04
531041500	CESTINO 1/2 per F18-90G EN Basket 1/2 for F18-90G • DE Korb 1/2 für Friteuse F18-90G • FR Panier 1/2 pour F18-90G • ES CESTA 1/2 PARA F18-90G cm. 10x 45x 15h			84,00 0.8 / 0,04
531041400	CESTINO 1/1 per F25-G/E + F25-ETD EN Basket 1/1 for F25-G/E + F25-ETD • DE Korb 1/1 für Friteuse F25-G/E + F25-ETD • FR Panier 1/1 pour F25-G/E + F25-ETD • ES CESTA 1/1 PARA F25-G/E + F25-ETD cm. 28x 45x 15h			146,00 1.5 / 0,07

ACCESSORI FRIGGITRICI

MOD. _____ DESCRIZIONE/DESCRIPTION/BEZEICHNUNG/DESCRIPTION/DESCRIPCIÓN POTENZA/POWER/LEISTUNG/PUISSANCE/POTENCIA ⚡kW ⚡kw PREZZO/PRICE €
 COD. _____ DIMENSIONI/DIMENSIONS/ABMESSUNGEN/DIMENSIONS/DIMENSIONES VOLTAGGIO/VOLTAGE/SPANNUNG/VOLTAGE/VOLTAJE kcal/h V~ Hz PREIS/PRIX/PRECIO €
 KG / M³

531041300 CESTINO 1/1 per F18-ETD (standard in F18-E)
EN Basket 1/1 for F18-ETD (standard F18-E) • **DE** korb 1/1 für F18-ETD (standard F18-E) • **FR** Panier 1/1 pour F18-ETD (standard F18-E)
 • **ES CESTA 1/1 PARA F18-ETD (STANDARD F18-E)**
cm. 28x 29x 15h



91,00
 1.5 / 0,06

KITSS-90 KIT SCIOGLIMENTO STRUTTO, solo per friggitorie elettriche a mobile.
EN Kit for lard melting, only for electric fryers on cabinet • **DE** Satz fuer schmalzschmelzen, nur für elektrische Friteusen mit unterbau • **FR** Kit de dissolution lard, seulement pour les friteuses électriques sur armoire • **ES KIT DE DISOLUCIÓN DE MANTECA, SÓLO PARA FREIDORAS ELÉCTRICAS ON MUEBLE**

⚡ 0,31 KW _____ **135,00**
 _____ / 0,01

BF30 BACINELLA RACCOGLI OLIO CON FILTRO LT. 30 PER FRIGGITRICE
EN 30 lts. oil collecting tray - With filter for deep fryer • **DE** Ölauffangwanne mit Filter, 30 Liter, für Friteuse • **FR** Bac de récupération de l'huile Avec filtre 30 lt. pour friteuse • **ES BANDEJA PARA ACEITE CON FILTRO - 30 LT. PARA FREIDORA**
cm. 29x 29x 37h



241,00
 7 / 0,10

09550400 COPERCHIO per BRF-94
EN Lid for BFR-94 • **DE** Deckel für BFR-94 • **FR** Couvercle pour BFR-94
 • **ES TAPA PARA BFR-94**
cm. 32x 70x 5h

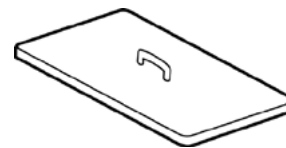

154,00
 2.5 / 0,01

09550800 COPERCHIO per BRF-98
EN Lid for BFR-98 • **DE** Deckel für BFR-98 • **FR** Couvercle pour BFR-98
 • **ES TAPA PARA BFR-98**
cm. 72x 70x 5h

205,00
 5 / 0,02

TG-94 TAGLIERE PLASTICA
EN Plastic chopping-board • **DE** Schneidebrett • **FR** Plan de decoupe
 • **ES PICADOR DE PLÁSTICO**
cm. 39x 75x 2,5h

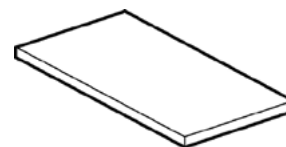

163,00
 8 / 0,01

TG-98 **cm. 79x 75x 2,5h**

328,00
 14 / 0,03

PLF/9 PIASTRA LISCIA per GRIGLIA IN GHISA
EN Smooth griddle plate for cast iron grid • **DE** Fortkochplatte glatt für Gusseisen Rost • **FR** Plaque lisse pour la grille en fonte • **ES PLANCHA LISA PARA REJILLA DE HIERRO FUNDIDO**
cm. 36x 39



216,00
 11 / 0,01

PRF/9 PIASTRA RIGATA per GRIGLIA IN GHISA
EN Grooved griddle plate for cast iron grid • **DE** Fortkochplatte gerillt für Gusseisen Rost • **FR** Plaque nervurée pour la grille en fonte • **ES PLANCHA ESTRIADA PARA REJILLA DE HIERRO FUNDIDO**
cm. 36x 39

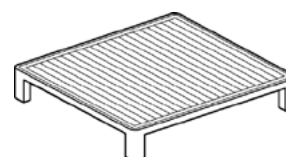

291,00
 11 / 0,01

ACCESSORI

MOD. COD.	DESCRIZIONE/DESCRIPTION/BEZEICHNUNG/DESCRIPTION/DESCRIPCIÓN DIMENSIONI/DIMENSIONS/ABMESSUNGEN/DIMENSIONS/DIMENSIONES	POTENZA/POWER/LEISTUNG/PUISSANCE/POTENCIA VOLTAGGIO/VOLTAGE/SPANNUNG/VOLTAGE/VOLTAJE	kW kcal/h	kW V~ Hz	PREZZO/PRICE PREIS/PRIX/PRECIO € KG / M³
PLFT/9 09590451	PIASTRA LISCIA per GRIGLIA IN TONDINO EN Smooth griddle plate for grid rod • DE Fortkochplatte glatt für Gitterstab • FR Plaque lisse pour tige grille • ES PLANCHA LISA POR RED DE VARILLA cm. 36x 39				210,00 11 / 0,01
PRFT/9 09590453	PIASTRA RIGATA per GRIGLIA IN TONDINO EN Grooved griddle plate for grid rod • DE Fortkochplatte gerillt für Gitterstab • FR Plaque nervurée pour tige grille • ES PLANCHA ESTRIADA POR RED DE VARILLA cm. 36x 39				280,00 11 / 0,01
533009200	GRIGLIA DI RIDUZIONE EN Reduction • DE Reduzierstern • FR Grille de réduction • ES REJILLA DE REDUCCIÓN cm. 25x 25				43,00 0.2 / 0,00
KIT-WOK 09580040	KIT WOK - fiamma verticale - solo su bruciatore da 10 KW e griglie in ghisa EN KIT WOK - vertical flame - only for 10 kW burner and cast iron grills • DE KIT WOK - vertikaler Flamme - nur 10 kW-Brenner und Roste aus Gusseisen • FR KIT WOK - verticale de la flamme - seulement 10 kW brûleur et grilles en fonte • ES KIT WOK - LLAMA VERTICAL - SÓLO 10 KW QUEMADOR Y PARRILAS DE HIERRO COLADO cm. Ø 26x 16h				456,00 5 / 0,02
544439900	ANELLO PER WOK - solo per griglie in ghisa EN Wok ring - only for cast iron grills • DE Wok Aufsatzring - nur für Roste aus Gusseisen • FR Anneau Wok - seulement pour grilles en fonte • ES ANILLO WOK - SOLO PARA PARRILAS DE HIERRO COLADO cm. Ø22,5x 3,5h				170,00 2 / 0,00
RV 08660410	RISCALDANTE VANO CUCINA EN Heater for range's cabinet • DE Heizer für Herden-Schränkelement • FR Réchauffeur pour armoire du fourneau • ES CALEFACCIÓN PARA ARMARIO NEUTRO DE LA COCINA cm. 32x 48,5x 8h			0,75 kW 230V~ 50/60 Hz	975,00 8 / 0,08
RCRV-94 09450402	RIPIANO FORATO IN APPOGGIO PER RISCALDANTE SU VANO CUCINA EN Perforated shelf for heater element mod.RV for cooker cabinet • DE regale Gelocht für Heizer mod.RV für Herden-Schränkelement • FR Étagère perforées pour réchauffeur mod.RV pour armoire du fourneau • ES ESTANTE PERFORADO PARA ELEMENTO DE CALEFACCION MOD.RV PARA ARMARIO NEUTRO DE LA COCINA cm. 34x 75x 10h				511,00 6 / 0,04
RRV-94 09450401	RIPIANO FORATO IN APPOGGIO PER RISCALDANTE EN Perforated shelf for heater element mod.RV • DE regale Gelocht für Heizer mod.RV • FR Étagère perforées pour réchauffeur mod.RV • ES ESTANTE PERFORADO PARA ELEMENTO DE CALEFACCION MOD.RV cm. 34x 77x 10h				511,00 6 / 0,04
RRV-96 09450601	cm. 54x 77x 10h				889,00 9 / 0,06
RRV-98 09450801	cm. 74x 77x 10h				975,00 11 / 0,08

ACCESSORI

MOD. COD.	DESCRIZIONE/DESCRIPTION/BEZEICHNUNG/DESCRIPTION/DESCRIPCIÓN DIMENSIONI/DIMENSIONS/ABMESSUNGEN/DIMENSIONS/DIMENSIONES	POTENZA/POWER/LEISTUNG/PUISSANCE/POTENCIA VOLTAGGIO/VOLTAGE/SPANNUNG/VOLTAGE/VOLTAJE	⚡kW kcal/h	⚡kw V~ Hz	PREZZO/PRICE PREIS/PRIX/PRECIO € KG / M³
RRV-910 09451001	cm. 94x 77x 10h				1.380,00 14 / 0,10
RRV-912 09451201	cm. 114x 77x 10h				1.658,00 17 / 0,12
RRV-916 09451601	cm. 154x 77x 10h				2.258,00 22 / 0,16
PT-74/94 08460002	PORTATEGLIE VANO 400 (GN-1/1) VANO 600 (GN-2/1) 4 ripiani int. 7 cm. EN Frame for plates 400 (GN-1/1) 600 (GN-2/1) - N. 4 shelves, wheel-base 7 cm. • DE Aufhängeschienen für bleche 400 (GN-1/1) 600 (GN-2/1) - N. 4 Etagen, Abstand 7 cm. • FR Kit porte-plaques 400 (GN-1/1) 600 (GN-2/1) - N. 4 étagères; 7 cm. • ES PORTACAZUELAS 400 (GN-1/1) 600 (GN-2/1) - N. 4 ESTANTES, INT. 7 CM.				459,00 2.5 / 0,01
PT-78/98 08460012	PORTATEGLIE VANO 800 (GN-2/1) 4 ripiani int. 7 cm. EN Frame for plates 800 (GN-2/1) 4 Etagen, Abstand 7 cm. • DE Aufhängeschienen für bleche 800 (GN-2/1) N. 4 Etagen, Abstand 7 cm. • FR Kit porte-plaques 800 (GN-2/1) - N. 4 étagères; 7 cm. • ES PORTACAZUELAS 800 (GN-2/1) - N. 4 ESTANTES, INT. 7 CM.				613,00 4 / 0,01
09610400	MITRA 400 EN Chimney jack 400 • DE Lüftungsaufsatz 400 • FR Mitre 400 • ES CAPERUZA 400 cm. 40x 7x 92h				433,00 8 / 0,02
09610800	MITRA 800 EN Chimney jack 800 • DE Lüftungsaufsatz 800 • FR Mitre 800 • ES CAPERUZA 800 cm. 80x 7x 92h				632,00 16 / 0,04
09611200	MITRA 1200 EN Chimney jack 1200 • DE Lüftungsaufsatz 1200 • FR Mitre 1200 • ES CAPERUZA 1200 cm. 120x 7x 92h				845,00 24 / 0,06
09610402	MITRA 400 PER CPP-94G EN Chimney jack 400 for CPP-94G • DE Lüftungsaufsatz 400 für CPP-94G • FR Mitre 400 pour CPP-94G • ES CAPERUZA 400 PARA CPP-94G cm. 40x 7x 73h				632,00 8 / 0,02
09610401	CAMINO ANTIVENTO 400 EN Draught diverter 400 • DE Strömungssicherung 400 • FR Cheminee anti-vent 400 • ES CHIMENEA CONTRA VIENTO 400 cm. 40x 19x 120h				759,00 8 / 0,08
09610801	CAMINO ANTIVENTO 800 EN Draught diverter 800 • DE Strömungssicherung 800 • FR Cheminee anti-vent 800 • ES CHIMENEA CONTRA VIENTO 800 cm. 80x 19x 120h				889,00 16 / 0,15
09611201	CAMINO ANTIVENTO 1200 EN Draught diverter 1200 • DE Strömungssicherung 1200 • FR Cheminee anti-vent 1200 • ES CHIMENEA CONTRA VIENTO 1200 cm. 120x 19x 120h				1.173,00 24 / 0,25
09610403	CAMINO ANTIVENTO 400 PER CPP-94G EN Draught diverter 400 for CPP-94G • DE Strömungssicherung 400 für CPP-94G • FR Cheminee anti-vent 400 pour CPP-94G • ES CHIMENEA CONTRA VIENTO 400 PARA CPP-94G				759,00 8 / 0,08

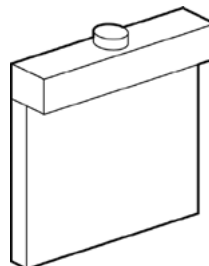
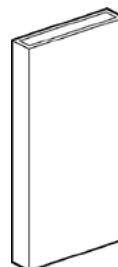
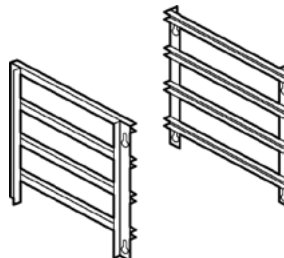

ACCESSORI

MOD. COD.	DESCRIZIONE/DESCRIPTION/BEZEICHNUNG/DESCRIPTION/DESCRIPCIÓN DIMENSIONI/DIMENSIONS/ABMESSUNGEN/DIMENSIONS/DIMENSIONES	POTENZA/POWER/LEISTUNG/PUISSANCE/POTENCIA VOLTAGGIO/VOLTAGE/SPANNUNG/VOLTAGE/VOLTAJE	⊕kW kcal/h	⊕kw V~ Hz	PREZZO/PRICE PREIS/PRIX/PRECIO €/M ³
SA-72/92 08600200	SCHIENA POSTERIORE A VISTA PER APPARECCHI EN Back cover • DE Ruckenwand • FR Dos de finition • ES PANEL POSTERIOR cm. 20x 1,5x 81h				112,00 2 / 0,01
SA-73/93 08600300	cm. 30x 1,5x 81h				127,00 3 / 0,01
SA-74/94 08600400	cm. 40x 1,5x 81h				146,00 3 / 0,01
SA-75/95 08600500	cm. 50x 1,5x 81h				184,00 4 / 0,01
SA-76/96 08600600	cm. 60x 1,5x 81h				212,00 4 / 0,02
SA-77/97 08600700	cm. 70x 1,5x 81h				225,00 5 / 0,02
SA-78/98 08600800	cm. 80x 1,5x 81h				247,00 5 / 0,02
SA-79/99 08600900	cm. 90x 1,5x 81h				278,00 6 / 0,02
SA-710/910 08601000	cm. 100x 1,5x 81h				308,00 6 / 0,03
SA-711/911 08601100	cm. 110x 1,5x 81h				341,00 7 / 0,03
SA-712/912 08601200	cm. 120x 1,5x 81h				372,00 7 / 0,03
SA-713/913 08601300	cm. 130x 1,5x 81h				403,00 8 / 0,03
SA-714/914 08601400	cm. 140x 1,5x 81h				432,00 8 / 0,04
SA-715/915 08601500	cm. 150x 1,5x 81h				462,00 10 / 0,04
SA-716/916 08601600	cm. 160x 1,5x 81h				492,00 10 / 0,04
SA-94CPPG 08600402	SCHIENA POSTERIORE A VISTA PER CUOCIPASTA GAS CPP-94G EN Back cover for Gas pasta cooker CPP-94G • DE Ruckenwand für Gas-Nudelkocher CPP-94G • FR Dos de finition pour Cuiseur a pates gaz CPP-94G • ES PANEL POSTERIOR PARA CUECE PASTA GAS CPP-94G cm. 40x 1,5x 100h				168,00 3 / 0,01
SA-98CPPG 08600802	SCHIENA POSTERIORE A VISTA PER CUOCIPASTA GAS CPP-98G EN Back cover for Gas pasta cooker CPP-98G • DE Ruckenwand für Gas-Nudelkocher CPP-98G • FR Dos de finition pour Cuiseur a pates gaz CPP-98G • ES PANEL POSTERIOR PARA CUECE PASTA GAS CPP-98G cm. 80x 1,5x 100h				269,00 6 / 0,03



ACCESSORI

MOD. _____
COD. _____

DESCRIZIONE/DESCRIPTION/BEZEICHNUNG/DESCRIPTION/DESCRIPCIÓN
DIMENSIONI/DIMENSIONS/ABMESSUNGEN/DIMENSIONS/DIMENSIONES

POTENZA/POWER/LEISTUNG/PUISSANCE/POTENCIA
VOLTAGGIO/VOLTAGE/SPANNUNG/VOLTAGE/VOLTAJE

⚡ kW kcal/h ⚡ kw V~ Hz

PREZZO/PRICE €
PREIS/PRIX/PRECIO €
KG / M³

KIT-TOPM-SA 08600001 KIT TAMPONAMENTI LATERALI per schiena posteriore montata su apparecchi TOP e mobili "M..."
EN Side KIT for back cover mounted on the TOP machine and Stand "M..." • **DE** Seitliches KIT für Rückenwand montiert auf der TOP-Maschine und Unterbau "M..." • **FR** KIT latéral pour Dos de finition monté sur la machine TOP et Placard "M..." • **ES KIT LATERAL PARA PANEL POSTERIORE MONTADO EN LA MÁQUINA TOP Y MUEBLE BASE "M..."**



99,00
1 / 0,01

TPC-9 09560002 TESTATA CHIUSURA PER CF-PC-TP (SOLO GAS) (in dotazione 1 pezzo per apparecchio)
EN Head end filler strip for CF-PC-TP (Gas only) (1 piece included in each machine) • **DE** Abschluss-Element für CF-PC-TP (nur gas) (1 Stück in jeder Maschine enthalten) • **FR** Élément de jonction pour CF-PC-TP (seulement gaz) (1 pièce incluse dans chaque machine) • **ES CHAPA DE CIERRE PARA CF-PC-TP (SOLO GAS) (1 PIEZA INCLUIDA EN CADA EQUIPO)**
cm. 0,2x 70,5



77,00
1 / 0,00

TPA-9 09560001 TESTATA CHIUSURA PER TUTTI GLI ALTRI MODELLI (in dotazione 1 pezzo per apparecchio)
EN Head end filler strip for all other models (1 piece included in each machine) • **DE** Abschluss-Element für alle anderen Modelle (1 Stück in jeder Maschine enthalten) • **FR** Élément de jonction pour tous les autres modèles (1 pièce incluse dans chaque machine) • **ES CHAPA DE CIERRE PARA TODOS LOS DEMÁS MODELOS (1 PIEZA INCLUIDA EN CADA EQUIPO)**
cm. 0,2x 70,5



77,00
1 / 0,00

TMA-9SX 09540901 TESTATA 1 LATO SERIE 90 SINISTRA
EN Head 1 side S90 left • **DE** Abschluss element 1 seite S90 links • **FR** Element de jonction 1 coté S90 gauche • **ES EMBELLECEDOR 1 LADO S90 IZQUIERDA**
cm. 0,2x 90



295,00
10 / 0,05

TMA-9DX 09540900 TESTATA 1 LATO SERIE 90 DESTRA
EN Head 1 side S90 right • **DE** Abschluss element 1 seite S90 recht • **FR** Element de jonction 1 coté S90 droit • **ES EMBELLECEDOR 1 LADO S90 DERECHA**
cm. 0,2x 90



295,00
10 / 0,05

TMA-99 09549900 TESTATA 2 LATI SERIE 90
EN Head 2 sides S90 • **DE** Abschluss element seiten S90 • **FR** Element de jonction 2 cotés S90 • **ES EMBELLECEDOR 2 LADOS S90**
cm. 0,2x180



589,00
20 / 0,10

ACCESSORI

MOD. COD.	DESCRIZIONE/DESCRIPTION/BEZEICHNUNG/DESCRIPTION/DESCRIPCIÓN DIMENSIONI/DIMENSIONS/ABMESSUNGEN/DIMENSIONS/DIMENSIONES	POTENZA/POWER/LEISTUNG/PUISSANCE/POTENCIA VOLTAGGIO/VOLTAGE/SPANNUNG/VOLTAGE/VOLTAJE	$\frac{kW}{kcal/h}$ $\frac{kW}{V \cdot Hz}$	PREZZO/PRICE € KG / M ³
---------------------	---	---	---	--

TMTA-9SX
09540921

TESTATA TAMBURATA 1 LATO SERIE 90 SINISTRA, con stesso profilo linea frontale
EN Head 1 side S90 left, with the same front line profile • **DE** Abschluss element 1 seite S90 links, mit dem gleichen Frontlinienprofil • **FR** Element de jonction 1 coté S90 gauche, avec le même profil de ligne • **ES** **EMBELLECEDOR 1 LADO S90 IZQUIERDA, CON EL MISMO PERFIL DE LÍNEA FRONTAL**
cm. 7,5x 90



920,00
16 / 0,20

TMTA-9DX
09540920

TESTATA TAMBURATA 1 LATO SERIE 90 DESTRA, con stesso profilo linea frontale
EN Head 1 side S90 right, with the same front line profile • **DE** Abschluss element 1 seite S90 recht, mit dem gleichen Frontlinienprofil • **FR** Element de jonction 1 coté S90 droit, avec le même profil de ligne • **ES** **EMBELLECEDOR 1 LADO S90 DERECHA, CON EL MISMO PERFIL DE LÍNEA FRONTAL**
cm. 7,5x 90



920,00
16 / 0,20

TMTA-99
09549920

TESTATA TAMBURATA 2 LATI SERIE 90, con stesso profilo linea frontale
EN Head 2 sides S90, with the same front line profile • **DE** Abschluss element seiten S90, mit dem gleichen Frontlinienprofil • **FR** Element de jonction 2 cotés S90, avec le même profil de ligne • **ES** **EMBELLECEDOR 2 LADOS S90, CON EL MISMO PERFIL DE LÍNEA FRONTAL**
cm. 7,5x 180



1.759,00
32 / 0,38

SIA-7/9
08480000

STAFFA INFERIORE UNIONE APPARECCHI
EN Lower bracket to join two items

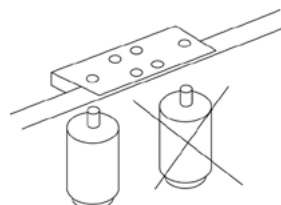

64,00
2 / 0,00

ACCESSORI

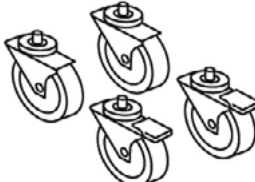
MOD. COD.	DESCRIZIONE/DESCRIPTION/BEZEICHNUNG/DESCRIPTION/DESCRIPCIÓN DIMENSIONI/DIMENSIONS/ABMESSUNGEN/DIMENSIONS/DIMENSIONES	POTENZA/POWER/LEISTUNG/PUISSANCE/POTENCIA VOLTAGGIO/VOLTAGE/SPANNUNG/VOLTAGE/VOLTAJE	kw kcal/h	kw V- Hz	PREZZO/PRICE PREIS/PRIX/PRECIO € KG / M ³
SR-100 50900001	SET 4 RUOTE Ø 100x30, 2 con freno EN Set of 4 wheels Ø 100x30, 2 with brake • DE 4 Rollen Satz Ø 100x30, 2 davon mit Feststellbremse • FR Kit 4 roues Ø 100x30, 2 avec frein • ES EQUIPO 4 RUEDAS Ø 100X30, 2 CON FRENOS cm. 12,7h				383,00 1 / 0,01
					
08570103	Mensola anteriore EN Earlier shelf • DE Frühere Regal • FR Plus tôt plateau • ES A PRINCIPIOS DE LA PLATAFORMA cm. 30x 21x 5h				438,00 / 0,01
08570104	cm. 40x 21x 5h				451,00 / 0,01
08570105	cm. 50x 21x 5h				464,00 / 0,01
08570106	cm. 60x 21x 5h				477,00 / 0,01
08570107	cm. 70x 21x 5h				488,00 / 0,01
08570108	cm. 80x 21x 5h				500,00 / 0,01
08570109	cm. 90x 21x 5h				514,00 / 0,02
08570110	cm. 100x 21x 5h				526,00 / 0,02
08570111	cm. 110x 21x 5h				541,00 / 0,02
08570112	cm. 120x 21x 5h				555,00 / 0,02
08570113	cm. 130x 21x 5h				573,00 / 0,02
08570114	cm. 140x 21x 5h				586,00 / 0,02
08570115	cm. 150x 21x 5h				605,00 / 0,02
08570116	cm. 160x 21x 5h				622,00 / 0,03

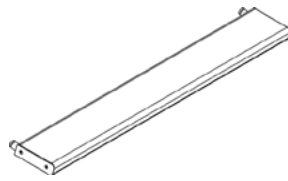

ACCESSORI

MOD. COD.	DESCRIZIONE/DESCRIPTION/BEZEICHNUNG/DESCRIPTION/DESCRIPCIÓN DIMENSIONI/DIMENSIONS/ABMESSUNGEN/DIMENSIONS/DIMENSIONES	POTENZA/POWER/LEISTUNG/PUISSANCE/POTENCIA VOLTAGGIO/VOLTAGE/SPANNUNG/VOLTAGE/VOLTAJE	$\frac{kW}{kcal/h}$ $\frac{V\sim}{Hz}$	PREZZO/PRICE PREIS/PRIX/PRECIO €/KG / M ³
08570002	Corrimano EN Handrail • DE Hand Lauf • FR Main courante • ES PASAMANO cm. 20x 7x 4h			368,00 / 0,00
08570003	cm. 30x 7x 4h			374,00 / 0,00
08570004	cm. 40x 7x 4h			378,00 / 0,00
08570005	cm. 50x 7x 4h			388,00 / 0,00
08570006	cm. 60x 7x 4h			401,00 / 0,00
08570007	cm. 70x 7x 4h			407,00 / 0,00
08570008	cm. 80x 7x 4h			414,00 / 0,01
08570009	cm. 90x 7x 4h			420,00 / 0,01
08570010	cm. 100x 7x 4h			427,00 / 0,01
08570011	cm. 110x 7x 4h			438,00 / 0,01
08570012	cm. 120x 7x 4h			451,00 / 0,01
08570013	cm. 130x 7x 4h			465,00 / 0,01
08570014	cm. 140x 7x 4h			482,00 / 0,01
08570015	cm. 150x 7x 4h			525,00 / 0,01
08570016	cm. 160x 7x 4h			568,00 / 0,01

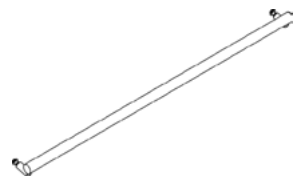

533116300	Giunzione corrimano EN junction handrail • DE Gelenk Hand lauf • FR Main courante de l'embranchement • ES CONEXIÓN PASAMANO cm. Ø 3x 2,4			58,00 / 1,00
-----------	--	--	--	-----------------

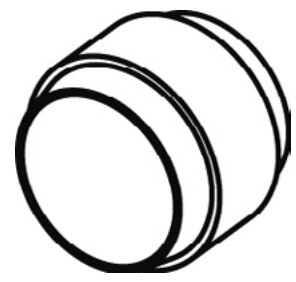

ZB 01410000	ZOCOLATURA BASE EN FRONT PLINTH • DE GRUNDSOCKEL • FR PLINTHE FRONTAL • ES ZOCCOLOS BASE €/m x cm. 15h			154,00 /
----------------	---	--	--	-------------



ACCESSORI

MOD. _____
COD. _____

DESCRIZIONE/DESCRIPTION/BEZEICHNUNG/DESCRIPTION/DESCRIPCIÓN
DIMENSIONI/DIMENSIONS/ABMESSUNGEN/DIMENSIONS/DIMENSIONES

POTENZA/POWER/LEISTUNG/PUISSANCE/POTENCIA
VOLTAGGIO/VOLTAGE/SPANNUNG/VOLTAGE/VOLTAJE

⚡ kW kcal/h
⚡ kw V- Hz

PREZZO/PRICE €
PREIS/PRIX/PRECIO €
KG / M³

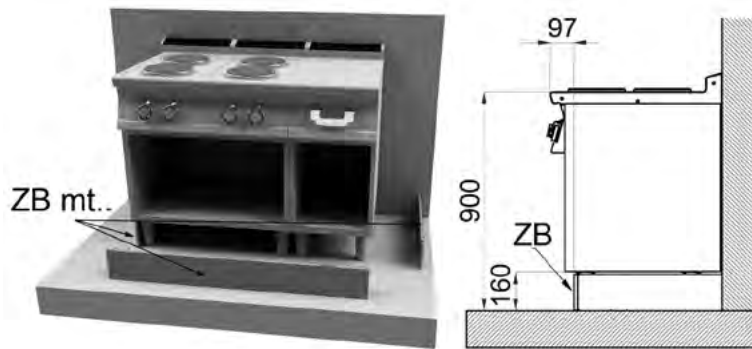

FZ-9
09480001

ZOCCOLATURA LATERALE - KIT
EN side plinth - kit • **DE** seitensockel - kit • **FR** plinthe lateral - kit
• **ES ZOCCOLOS LATERAL - KIT**
cm. 1,5x 80x 6h



324,00
/

CZ-72/92
08480002

KIT CASSETTO ZOCCOLO, inclusi 4 piedini
EN drawer clog - kit (4 small feet included) • **DE** schubladen sockel - kit
(4 kleine FüÙe enthalten) • **FR** tiroir plinthe - kit (4 petits pieds inclus)
• **ES CAJON ZOCCOLOS - KIT (4 PIES PEQUENO INDLUIDO)**
cm. 20x 61x 5,5h



186,00
3 / 0,01

CZ-93
09480003

cm. 30x 81x 5,5h

254,00
4 / 0,02

CZ-94
09480004

cm. 40x 81x 5,5h

287,00
4.5 / 0,03

CZ-96
09480006

cm. 60x 81x 5,5h

356,00
5.5 / 0,04

CZ-98
09480008

cm. 80x 81x 5,5h

440,00
7.5 / 0,06

CZ-912
09480012

cm. 120x 81x 5,5h

603,00
8.5 / 0,08

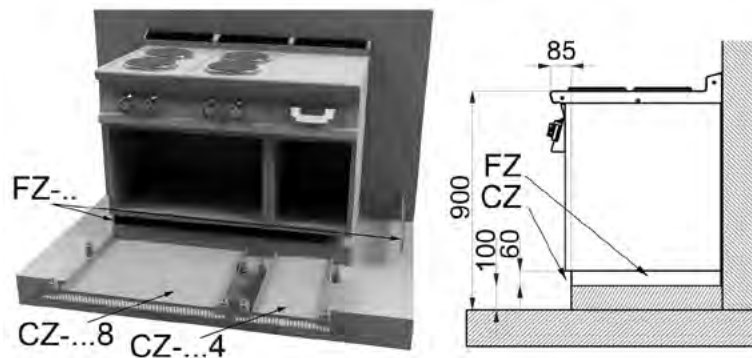

PIANI LAVORO - TOP

MOD. _____ DESCRIZIONE/DESCRIPTION/BEZEICHNUNG/DESCRIPTION/DESCRIPCIÓN POTENZA/POWER/LEISTUNG/PUISSANCE/POTENCIA kW kcal/h PREZZO/PRICE €
 COD. _____ DIMENSIONI/DIMENSIONS/ABMESSUNGEN/DIMENSIONS/DIMENSIONES VOLTAGGIO/VOLTAGE/SPANNUNG/VOLTAGE/VOLTAGE V~ Hz PREIS/PRIX/PRECIO €
 KG / M³

PLT-92 PIANO LAVORO (inclusa 1 testata chiusura piano mod.TPA-9) **742,00**
 19010200 **EN** Worktop (included 1 Head end filler strip mod.TPA-9) • **DE** **18 / 0,23**
 Arbeitsplatte (inbegriffen 1 Abschluss-Element mod.TPA-9) • **FR** Plan de **ES SOBRE DE**
 travail (inclus 1 Elément de jonction top mod.TPA-9) • **ES SOBRE DE**
TRABAJO (INCLUIDA 1 CHAPA DE CIERRE PARA TOP MOD. TPA-9)
cm. 20x 90x 28h



PLST-93 **cm. 30x 90x 28h** **770,00**
 19010301 **22 / 0,23**



PLST-94 **cm. 40x 90x 28h** **786,00**
 19010401 **23 / 0,23**



PLST-96 **cm. 60x 90x 28h** **1.265,00**
 19010601 **29 / 0,33**

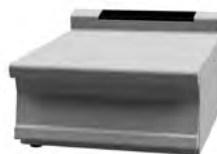

PLST-98 **cm. 80x 90x 28h** **1.406,00**
 19010801 **35 / 0,44**



PLT-93 PIANO LAVORO Cassetto 19x50x15h inox (inclusa 1 testata chiusura **1.092,00**
 piano mod.TPA-9) **25 / 0,23**
 19010300 **EN** Worktop - Drawer cm. 19x50x15h (included 1 Head end filler strip **ES SOBRE**
 mod.TPA-9) • **DE** Arbeitsplatte - Schublade cm. 19x50x15h (inbegriffen **DE TRABAJO. CAJÓN CM. 19X50X15H INOX (INCLUIDA 1**
 1 Abschluss-Element mod.TPA-9) • **FR** Plan de travail - Tiroir inox cm. **CHAPA DE CIERRE PARA TOP MOD.TPA-9)**
 19x50x15h (inclus 1 Elément de jonction top mod.TPA-9) • **cm. 30x 90x 28h**



PLT-94 PIANO LAVORO Cassetto con 1 bacinella GN 1/1 15h plastica (inclusa 1 **1.048,00**
 testata chiusura piano mod.TPA-9) **28 / 0,23**
 19010400 **EN** Worktop - Drawer with 1 plastic container GN 1/1 15h (included 1 **ES SOBRE DE TRABAJO**
 Head end filler strip mod.TPA-9) • **DE** Arbeitsplatte - Schublade mit 1 **CAJÓN CON 1 CONTENEDOR GN 1/1 15H PLÁSTICO**
 GN 1/1 15h Kunststoffbehälter (inbegriffen 1 Abschluss-Element mod.TPA-9) • **(INCLUIDA 1 CHAPA DE CIERRE PARA TOP MOD.TPA-9)**
 1 Elément de jonction top mod.TPA-9) • **cm. 40x 90x 28h**



PIANI LAVORO - TOP

MOD. _____
COD. _____

DESCRIZIONE/DESCRIPTION/BEZEICHNUNG/DESCRIPTION/DESCRIPCIÓN
DIMENSIONI/DIMENSIONS/ABMESSUNGEN/DIMENSIONS/DIMENSIONES

POTENZA/POWER/LEISTUNG/PUISSANCE/POTENCIA
VOLTAGGIO/VOLTAGE/SPANNUNG/VOLTAGE/VOLTAJE

⚡ kW _____
kcal/h _____
V~ _____
Hz _____

PREZZO/PRICE € _____
PREIS/PRIX/PRECIO € _____
KG / M³ _____

PLT-96
19010600

PIANO LAVORO Cassetto 49x50x15h inox (inclusa 1 testata chiusura piano mod.TPA-9)
EN Worktop - Drawer cm. 49x50x15h (included 1 Head end filler strip mod.TPA-9) • **DE** Arbeitsplatte - Schublade cm. 49x50x15h (inbegriffen 1 Abschluss-Element mod.TPA-9) • **FR** Plan de travail - Tiroir inox cm. 49x50x15h (inclus 1 Élément de jonction top mod.TPA-9) • **ES SOBRE DE TRABAJO. CAJÓN CM. 49X50X15H INOX (INCLUIDA 1 CHAPA DE CIERRE PARA TOP MOD.TPA-9)**
cm. 60x 90x 28h



1.558,00
38 / 0,33

PLT-98
19010800

PIANO LAVORO Cassetto con 2 bacinelle GN 1/1 15h plastica (inclusa 1 testata chiusura piano mod.TPA-9)
EN Worktop - Drawer with 2 plastic containers GN 1/1 15h (included 1 Head end filler strip mod.TPA-9) • **DE** Arbeitsplatte - Schublade mit 2 GN 1/1 15h Kunststoffbehältern (inbegriffen 1 Abschluss-Element mod.TPA-9) • **FR** Plan de travail - Tiroir avec 2 bacs en plastique GN 1/1 15h (inclus 1 Élément de jonction top mod.TPA-9) • **ES SOBRE DE TRABAJO CAJÓN CON 2 CONTENEDORES GN 1/1 15H PLÁSTICO (INCLUIDA 1 CHAPA DE CIERRE PARA TOP MOD.TPA-9)**
cm. 80x 90x 28h



1.729,00
46 / 0,44

LAT-94
19020400

LAVELLO Rubinetto a leva - Vasca cm. 30x35x15h (inclusa 1 testata chiusura piano mod.TPA-9)
EN Sink unit - Lever type tap - Bowl cm. 30x35x15h (included 1 Head end filler strip mod.TPA-9) • **DE** Spülbecken - Einhebel-Mischbatterie Becken cm. 30x35x15h (inbegriffen 1 Abschluss-Element mod.TPA-9) • **FR** Bac-évier avec robinetterie - Bac cm 30x35x15h (inclus 1 Élément de jonction top mod.TPA-9) • **ES FREGADERO - GRIFO A PALANCA - PILETA CM. 30X35X15H (INCLUIDA 1 CHAPA DE CIERRE PARA TOP MOD.TPA-9)**
cm. 40x 90x 28h



1.317,00
24 / 0,23

PCT-94ET
19030430

PIANO COTTURA TRIFASE N. 2 piastre (inclusa 1 testata chiusura piano mod.TPA-9)
EN Boiling unit threephase - N. 2 plates (included 1 Head end filler strip mod.TPA-9) • **DE** Kochplatte dreiphasig - N. 2 Kochplatten (inbegriffen 1 Abschluss-Element mod.TPA-9) • **FR** Rechaud électriques - N. 2 plaques (inclus 1 Élément de jonction top mod.TPA-9) • **ES SOBRE DE COCCIÓN TRIFÁSICO - N. 2 PLANCHAS (INCLUIDA 1 CHAPA DE CIERRE PARA TOP MOD.TPA-9)**
cm. 40x 90x 28h



⚡ 7 kW _____
400V~2N _____
230V~3 _____
230V~ _____
50/60 Hz _____

1.529,00
29 / 0,23



PCT-98ET
19030830

PIANO COTTURA TRIFASE N. 4 piastre (inclusa 1 testata chiusura piano mod.TPA-9)
EN Boiling unit threephase - N. 4 plates (included 1 Head end filler strip mod.TPA-9) • **DE** Kochplatte dreiphasig - N. 4 Kochplatten (inbegriffen 1 Abschluss-Element mod.TPA-9) • **FR** Rechaud électriques - N. 4 plaques (inclus 1 Élément de jonction top mod.TPA-9) • **ES SOBRE DE COCCIÓN TRIFÁSICO - N. 4 PLANCHAS (INCLUIDA 1 CHAPA DE CIERRE PARA TOP MOD.TPA-9)**
cm. 80x 90x 28h



⚡ 14 kW _____
400V~3N _____
50/60 Hz _____

3.078,00
68 / 0,44



PCT-912ET
19031230

PIANO COTTURA TRIFASE N. 6 piastre (inclusa 1 testata chiusura piano mod.TPA-9)
EN Boiling unit threephase - N. 6 plates (included 1 Head end filler strip mod.TPA-9) • **DE** Kochplatte dreiphasig - N. 6 Kochplatten (inbegriffen 1 Abschluss-Element mod.TPA-9) • **FR** Rechaud électriques - N. 6 plaques (inclus 1 Élément de jonction top mod.TPA-9) • **ES SOBRE DE COCCIÓN TRIFÁSICO - N. 6 PLANCHAS (INCLUIDA 1 CHAPA DE CIERRE PARA TOP MOD.TPA-9)**
cm. 120x 90x 28h



⚡ 21 kW _____
400V~3N _____
50/60 Hz _____

4.220,00
94 / 0,64

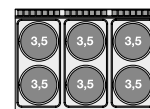

PIANI COTTURA ELETTRICI - TOP

MOD. _____ DESCRIZIONE/DESCRIPTION/BEZEICHNUNG/DESCRIPTION/DESCRIPCIÓN POTENZA/POWER/LEISTUNG/PUISSANCE/POTENCIA ⚡ kW ⚡ kW PREZZO/PRICE €
 COD. _____ DIMENSIONI/DIMENSIONS/ABMESSUNGEN/DIMENSIONS/DIMENSIONES VOLTAGGIO/VOLTAGE/SPANNUNG/VOLTAGE/VOLTAJE kcal/h V~ / Hz PREIS/PRIX/PRECIO € KG / M³

PCQT-94ET 19030431 PIANO COTTURA TRIFASE - N. 2 piastre quadre (inclusa 1 testata chiusura piano mod.TPA-9)
EN Boiling unit threephase - N. 2 square plates (included 1 Head end filler strip mod.TPA-9) • **DE** Kochplatte dreiphasig - N. 2 quadratischen Platten (inbegriffen 1 Abschluss-Element mod.TPA-9) • **FR** Rechaud électriques - N. 2 plaques carrés (inclus 1 Élément de jonction top mod.TPA-9) • **ES SOBRE DE COCCIÓN TRIFÁSICO - N. 2 PLANCHAS CUADRADAS (INCLUIDA 1 CHAPA DE CIERRE PARA TOP MOD.TPA-9)**
cm. 40x 90x 28h



⚡ 8 kW 400V~2N 230V~3 230V~ 50/60 Hz

2.124,00
33 / 0,23



PCQT-98ET 19030831 PIANO COTTURA TRIFASE - N. 4 piastre quadre (inclusa 1 testata chiusura piano mod.TPA-9)
EN Boiling unit threephase - N. 4 square plates (included 1 Head end filler strip mod.TPA-9) • **DE** Kochplatte dreiphasig - N. 4 quadratischen Platten (inbegriffen 1 Abschluss-Element mod.TPA-9) • **FR** Rechaud électriques - N. 4 plaques carrés (inclus 1 Élément de jonction top mod.TPA-9) • **ES SOBRE DE COCCIÓN TRIFÁSICO - N. 4 PLANCHAS CUADRADAS (INCLUIDA 1 CHAPA DE CIERRE PARA TOP MOD.TPA-9)**
cm. 80x 90x 28h



⚡ 16 kW 400V~3N 50/60 Hz

3.923,00
71 / 0,44



PCQT-912ET 19031231 PIANO COTTURA TRIFASE - N. 6 piastre quadre (inclusa 1 testata chiusura piano mod.TPA-9)
EN Boiling unit threephase - N. 6 square plates (included 1 Head end filler strip mod.TPA-9) • **DE** Kochplatte dreiphasig - N. 6 quadratischen Platten (inbegriffen 1 Abschluss-Element mod.TPA-9) • **FR** Rechaud électriques - N. 6 plaques carrés (inclus 1 Élément de jonction top mod.TPA-9) • **ES SOBRE DE COCCIÓN TRIFÁSICO - N. 6 PLANCHAS CUADRADAS (INCLUIDA 1 CHAPA DE CIERRE PARA TOP MOD.TPA-9)**
cm. 120x 90x 28h



⚡ 24 kW 400V~3N 50/60 Hz

6.159,00
112 / 0,64



PCCT-94ET 19030432 PIANO COTTURA VETROCERAMICA TRIFASE - N. 2 zone - vetro cm.35x77 (inclusa 1 testata chiusura piano mod.TPA-9)
EN Ceramic glass boiling unit - n. 2 zones - glass cm.35x77 (included 1 Head end filler strip mod.TPA-9) • **DE** Ceran-Kochplatte dreiphasig - 2 zonen - Glas 35x77 cm (inbegriffen 1 Abschluss-Element mod.TPA-9) • **FR** Plan de cuisson à vitroceramique triphasé N. 2 zones - Verre cm.35x77 (inclus 1 Élément de jonction top mod.TPA-9) • **ES SOBRE DE COCCIÓN TRIFÁSICO VITROCERÁMICA - 2 ZONAS - VIDRO CM.35X77 (INCLUIDA 1 CHAPA DE CIERRE PARA TOP MOD.TPA-9)**
cm. 40x 90x 28h



⚡ 6,8 kW 400V~2N 230V~3 230V~ 50/60 Hz

2.634,00
38 / 0,23



PCCT-98ET 19030832 PIANO COTTURA VETROCERAMICA TRIFASE - N. 4 zone - vetro cm.75x77 (inclusa 1 testata chiusura piano mod.TPA-9)
EN Ceramic glass boiling unit - n. 4 zones - glass cm.75x77 (included 1 Head end filler strip mod.TPA-9) • **DE** Ceran-Kochplatte dreiphasig - 4 zonen - Glas 75x77 cm (inbegriffen 1 Abschluss-Element mod.TPA-9) • **FR** Plan de cuisson à vitroceramique triphasé N. 4 zones - Verre cm.75x77 (inclus 1 Élément de jonction top mod.TPA-9) • **ES SOBRE DE COCCIÓN TRIFÁSICO VITROCERÁMICA - 4 ZONAS - VIDRO CM.75X77 (INCLUIDA 1 CHAPA DE CIERRE PARA TOP MOD.TPA-9)**
cm. 80x 90x 28h



⚡ 13,6 kW 400V~3N 230V~3 50/60 Hz

4.614,00
70 / 0,44



PCIT-94ET 19030433 PIANO COTTURA INDUZIONE TRIFASE - N. 2 zone - Vetro cm.35x77 (non posizionare su forni o cassettiere) (inclusa 1 testata chiusura piano mod.TPA-9)
EN Three-phase induction cooking - 2 zones - glass cm.35x77 (do not place on ovens or drawers) (included 1 Head end filler strip mod.TPA-9) • **DE** Induktions-Kochplatte dreiphasig - 2 zonen - Glas 35x77 cm (nicht Platz auf Öfen oder Schubladen) (inbegriffen 1 Abschluss-Element mod.TPA-9) • **FR** Plan de cuisson à induction triphasé N. 2 zones - Verre cm.35x77 (ne placez pas sur des fours ou des tiroirs) (inclus 1 Élément de jonction top mod.TPA-9) • **ES ENCIMERA INDUCCIÓN TRIFÁSICA - 2 ZONAS - VIDRIO CM.35X77 (NO COLOQUE EN LOS HORNOS O EN LOS CAJONES) (INCLUIDA 1 CHAPA DE CIERRE PARA TOP MOD.TPA-9)**
cm. 40x 90x 28h



⚡ 10 kW 400V~3 50/60 Hz

8.786,00
38 / 0,23

PIANI COTTURA A INDUZIONE - TOP

MOD. _____
COD. _____

DESCRIZIONE/DESCRIPTION/BEZEICHNUNG/DESCRIPTION/DESCRIPCIÓN
DIMENSIONI/DIMENSIONS/ABMESSUNGEN/DIMENSIONS/DIMENSIONES

POTENZA/POWER/LEISTUNG/PUISSANCE/POTENCIA
VOLTAGGIO/VOLTAGE/SPANNUNG/VOLTAGE/VOLTAGE

⚡ kW _____
kcal/h _____
V~ _____
Hz _____

PREZZO/PRICE €
PREIS/PRIX/PRECIO €
KG / M³

PCIWT-94ET 19030434 PIANO COTTURA INDUZIONE TRIFASE "WOK" - N. 1 zona - Vetro Ø 30 cm. (non posizionare su forni o cassettiere) (inclusa 1 testata chiusura piano mod.TPA-9)
EN Three-phase induction cooking "WOK" - 1 zone - glass Ø 30 cm (do not place on ovens or drawers) (included 1 Head end filler strip mod. TPA-9) • **DE** Induktions-Kochplatte "WOK" dreiphasig - 1 zonen - Glas Ø 30 cm (nicht Platz auf Öfen oder Schubladen) (inbegriffen 1 Abschluss-Element mod.TPA-9) • **FR** Plan de cuisson à induction "WOK" triphasé N. 1 zone - Verre cm Ø 30 (ne placez pas sur des fours ou des tiroirs) (inclus 1 Élément de jonction top mod.TPA-9) • **ES ENCIMERA INDUCCIÓN "WOK" TRIFÁSICA - 1 ZONA - VIDRIO Ø 30 CM (NO COLOQUE EN LOS HORNOS O EN LOS CAJONES) (INCLUIDA 1 CHAPA DE CIERRE PARA TOP MOD.TPA-9) cm. 40x 90x 28h**



⚡ 5 kW _____ **6.426,00**
400V~3 _____ 34 / 0,23
50/60 Hz

PCIT-98ET 19030833 PIANO COTTURA INDUZIONE TRIFASE - N. 4 zone - Vetro cm.75x77 (non posizionare su forni o cassettiere) (inclusa 1 testata chiusura piano mod.TPA-9)
EN Three-phase induction cooking - 4 zones - glass cm.75x77 (do not place on ovens or drawers) (included 1 Head end filler strip mod.TPA-9) • **DE** Induktions-Kochplatte dreiphasig - 4 zonen - Glas 75x77 cm (nicht Platz auf Öfen oder Schubladen) (inbegriffen 1 Abschluss-Element mod. TPA-9) • **FR** Plan de cuisson à induction triphasé N. 4 zones - Verre cm.75x77 (ne placez pas sur des fours ou des tiroirs) (inclus 1 Élément de jonction top mod.TPA-9) • **ES ENCIMERA INDUCCIÓN TRIFÁSICA - 4 ZONAS - VIDRIO CM.75X77 (NO COLOQUE EN LOS HORNOS O EN LOS CAJONES) (INCLUIDA 1 CHAPA DE CIERRE PARA TOP MOD.TPA-9) cm. 80x 90x 28h**



⚡ 20 kW _____ **16.867,00**
400V~3 _____ 76 / 0,44
50/60 Hz

PIANI COTTURA A INDUZIONE - TOP

MOD. _____ DESCRIZIONE/DESCRIPTION/BEZEICHNUNG/DESCRIPTION/DESCRIPCIÓN POTENZA/POWER/LEISTUNG/PUISSANCE/POTENCIA $\frac{kW}{kcal/h}$ $\frac{kW}{V\sim}$ PREZZO/PRICE €
 COD. _____ DIMENSIONI/DIMENSIONS/ABMESSUNGEN/DIMENSIONS/DIMENSIONES VOLTAGGIO/VOLTAGE/SPANNUNG/VOLTAGE/VOLTAJE kcal/h Hz PREIS/PRIX/PRECIO €
 KG / M³

PCT-94G
19210450

PIANO COTTURA GAS 2 fuochi (inclusa 1 testata chiusura piano mod. TPC-9)
EN Gas heated boiling - 2 burners (included 1 Head end filler strip mod. TPC-9) • **DE** Gas-Kochplatte - 2 Kochstellen (inbegriffen 1 Abschluss-Element mod.TPC-9) • **FR** Rechaud gaz - 2 feux vifs (inclus 1 Élément de jonction top mod.TPC-9) • **ES SOBRES DE COCCIÓN GAS - 2 QUEMADORES (INCLUIDA 1 CHAPA DE CIERRE PARA TOP MOD.TPC-9)**
cm. 40x 90x 28h



$\frac{11 kW}{9.460 kcal/h}$ **1.888,00**
64 / 0,23

PCT-98G
19210850

PIANO COTTURA GAS 4 fuochi (inclusa 1 testata chiusura piano mod. TPC-9)
EN Gas heated boiling unit - 4 burners (included 1 Head end filler strip mod.TPC-9) • **DE** Gas-Kochplatte - 4 Kochstellen (inbegriffen 1 Abschluss-Element mod.TPC-9) • **FR** Rechaud gaz - 4 feux vifs (inclus 1 Élément de jonction top mod.TPC-9) • **ES SOBRES DE COCCIÓN GAS - 4 QUEMADORES (INCLUIDA 1 CHAPA DE CIERRE PARA TOP MOD.TPC-9)**
cm. 80x 90x 28h



$\frac{28 kW}{24.080 kcal/h}$ **3.307,00**
80 / 0,44

PCT-912G
19211250

PIANO COTTURA GAS 6 fuochi (inclusa 1 testata chiusura piano mod. TPC-9)
EN Gas heated boiling unit - 6 burners (included 1 Head end filler strip mod.TPC-9) • **DE** Gas-kochplatte - 6 Kochstellen (inbegriffen 1 Abschluss-Element mod.TPC-9) • **FR** Rechaud gaz - 6 feux vifs (inclus 1 Élément de jonction top mod.TPC-9) • **ES SOBRES DE COCCIÓN GAS - 6 QUEMADORES (INCLUIDA 1 CHAPA DE CIERRE PARA TOP MOD.TPC-9)**
cm. 120x 90x 28h



$\frac{45 kW}{38.700 kcal/h}$ **4.659,00**
131 / 0,64

PAT-98G
19210851

"PAELLERO" GAS (inclusa 1 testata chiusura piano mod.TPC-9)
EN "PAELLERO" Gas (included 1 Head end filler strip mod.TPC-9) • **DE** "PAELLERO" Gas (inbegriffen 1 Abschluss-Element mod.TPC-9) • **FR** "PAELLERO" gaz (inclus 1 Élément de jonction top mod.TPC-9) • **ES "PAELLERO" GAS (INCLUIDA 1 CHAPA DE CIERRE PARA TOP MOD.TPC-9)**
cm. 80x 90x 28h



$\frac{26,7 kW}{22.962 kcal/h}$ **4.808,00**
139 / 0,44

TPT-94G
19290450

TUTTA PIASTRA Piastra cm 39x73 (inclusa 1 testata chiusura piano mod. TPC-9)
EN Solid top - Plate 39x73 cm (included 1 Head end filler strip mod.TPC-9) • **DE** Kochplatte - Platte 39x73 cm (inbegriffen 1 Abschluss-Element mod.TPC-9) • **FR** Toute plaque - Plaque cm 39x73 (inclus 1 Élément de jonction top mod.TPC-9) • **ES PLACA DE COCCIÓN - PLACA CM 39X73 (INCLUIDA 1 CHAPA DE CIERRE PARA TOP MOD. TPC-9)**
cm. 40x 90x 28h

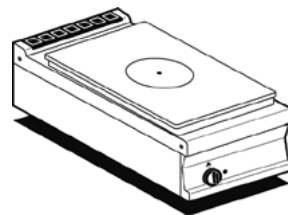

$\frac{7 kW}{6.020 kcal/h}$ **2.363,00**
64 / 0,23

TUTTAPIASTRA A GAS - TOP

MOD. _____
COD. _____

DESCRIZIONE/DESCRIPTION/BEZEICHNUNG/DESCRIPTION/DESCRIPCIÓN
DIMENSIONI/DIMENSIONS/ABMESSUNGEN/DIMENSIONS/DIMENSIONES

POTENZA/POWER/LEISTUNG/PUISSANCE/POTENCIA
VOLTAGGIO/VOLTAGE/SPANNUNG/VOLTAGE/VOLTAJE

⚡ kW _____
kcal/h _____
V~ _____
Hz _____

PREZZO/PRICE €
PREIS/PRIX/PRECIO €
KG / M³

TPT-98G
19290850

TUTTA PIASTRA Piastra cm 79x73 (inclusa 1 testata chiusura piano mod. TPC-9)
EN Solid top - Plate 79x73 cm (included 1 Head end filler strip mod.TPC-9) • **DE** Kochplatte - Platte 79x73 cm (inbegriffen 1 Abschluss-Element mod.TPC-9) • **FR** Toute plaque - Plaque cm. 79x73 (inclus 1 Élément de jonction top mod.TPC-9) • **ES PLACA DE COCCIÓN - PLACA CM 79X73 (INCLUIDA 1 CHAPA DE CIERRE PARA TOP MOD. TPC-9)**
cm. 80x 90x 28h



⚡ 12 kW _____ **3.468,00**
10.320 kcal/h _____ 137 / 0,44

TPT-98ET
19120830

TUTTA PIASTRA Piastra cm. 70x68 - 4 zone (inclusa 1 testata chiusura piano mod.TPA-9)
EN Solid top - Plate cm. 70x68 (included 1 Head end filler strip mod.TPA-9) • **DE** Kochplatten - Platte cm. 70x68 (inbegriffen 1 Abschluss-Element mod.TPA-9) • **FR** Toute plaque - Plaque cm. 70x68 (inclus 1 Élément de jonction top mod.TPA-9) • **ES PLACA DE COCCIÓN - PLACA CM. 70X68 (INCLUIDA 1 CHAPA DE CIERRE PARA TOP MOD. TPA-9)**
cm. 80x 90x 28h



⚡ 13,6 kW _____ **4.373,00**
400V~3N _____ 108 / 0,44
50/60 Hz

TPIT-98ET
19120833

TUTTOPIANO INDUZIONE TRIFASE - Vetro cm.75x77 (non posizionare su forni o cassettiere) (inclusa 1 testata chiusura piano mod.TPA-9)
EN Three-phase induction Solid top - glass cm.75x77 (do not place on ovens or drawers) (included 1 Head end filler strip mod.TPA-9) • **DE** Induktions-Kochplatte dreiphasig - Glas 75x77 cm (nicht Platz auf Öfen oder Schubladen) (inbegriffen 1 Abschluss-Element mod.TPA-9) • **FR** Toute plaque à induction triphasé - Verre cm.75x77 (ne placez pas sur des fours ou des tiroirs) (inclus 1 Élément de jonction top mod.TPA-9) • **ES PLACA DE COCCIÓN INDUCCIÓN TRIFÁSICA - VIDRIO CM.75X77 (NO COLOQUE EN LOS HORNOS O EN LOS CAJONES) (INCLUIDA 1 CHAPA DE CIERRE PARA TOP MOD. TPA-9)**
cm. 80x 90x 28h



⚡ 28 kW _____ **25.029,00**
400V~3 _____ 80 / 0,44
50/60 Hz

TP2T-98G
19300850

TUTTA PIASTRA + 2 FUOCHI - Piastra cm 39x73 (inclusa 1 testata chiusura piano mod.TPC-9)
EN Solid top + 2 burners - Plate 39x73 cm (included 1 Head end filler strip mod.TPC-9) • **DE** Kochplatte + 2 Gaskochstellen - Platte 39x73 cm (inbegriffen 1 Abschluss-Element mod.TPC-9) • **FR** Toute plaque + 2 brûleurs - Plaque cm 39x73 (inclus 1 Élément de jonction top mod.TPC-9) • **ES PLACA DE COCCIÓN + 2 FUEGOS - PLACA CM 39X73 (INCLUIDA 1 CHAPA DE CIERRE PARA TOP MOD.TPC-9)**
cm. 80x 90x 28h



⚡ 24 kW _____ **3.554,00**
20.640 kcal/h _____ 130 / 0,44

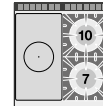

TP2T-912G
19291250

TUTTA PIASTRA + 2 FUOCHI Piastra cm. 79x73 (inclusa 1 testata chiusura piano mod.TPC-9)
EN Solid top + 2 burners - Plate 79x73 cm (included 1 Head end filler strip mod.TPC-9) • **DE** Kochplatte + 2 Gaskochstellen - Platte 79x73 cm (inbegriffen 1 Abschluss-Element mod.TPC-9) • **FR** Toute plaque + 2 brûleurs - Plaque cm. 79x73 (inclus 1 Élément de jonction top mod.TPC-9) • **ES PLACA DE COCCIÓN + 2 FUEGOS - PLACA CM. 79X73 (INCLUIDA 1 CHAPA DE CIERRE PARA TOP MOD.TPC-9)**
cm. 120x 90x 28h



⚡ 29 kW _____ **5.156,00**
24.940 kcal/h _____ 157 / 0,44

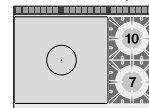

TUTTAPIASTRA A GAS - TOP

MOD. _____ DESCRIZIONE/DESCRIPTION/BEZEICHNUNG/DESCRIPTION/DESCRIPCIÓN POTENZA/POWER/LEISTUNG/PUISSANCE/POTENCIA $\frac{kW}{kcal/h}$ $\frac{kW}{V\sim}$ PREZZO/PRICE €
 COD. _____ DIMENSIONI/DIMENSIONS/ABMESSUNGEN/DIMENSIONS/DIMENSIONES VOLTAGGIO/VOLTAGE/SPANNUNG/VOLTAGE/VOLTAJE Hz PREIS/PRIX/PRECIO €
 KG / M³

TP4T-912G TUTTA PIASTRA + 4 FUOCHI Piastra cm. 39x73 (inclusa 1 testata
 19301250 chiusura piano mod.TPC-9)
EN Solid top + 4 burners - Plate 39x73 cm (included 1 Head end filler strip mod.TPC-9) • **DE** Kochplatte + 4 Gaskochstellen - Platte 39x73 cm (inbegriffen 1 Abschluss-Element mod.TPC-9) • **FR** Toute plaque + 4 brûleurs - Plaque cm. 39x73 (inclus 1 Élément de jonction top mod.TPC-9) • **ES PLACA DE COCCIÓN + 4 FUEGOS - PLACA CM. 39X73 (INCLUIDA 1 CHAPA DE CIERRE PARA TOP MOD.TPC-9) cm. 120x 90x 28h**



35 kW 4.863,00
 30.100 kcal/h 155 / 0,64

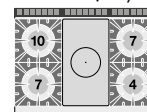

BMT-94EM BAGNOMARIA MONOFASE Vasca per GN 1/1 + GN 1/3 h.15 (inclusa
 19050410 1 testata chiusura piano mod.TPA-9)
EN Bain marie singlephase - Bowl for GN 1/1 + GN 1/3 h.15 (included 1 Head end filler strip mod.TPA-9) • **DE** Wasserbäder einphasig - Becken GN 1/1 + GN 1/3 h.15 (inbegriffen 1 Abschluss-Element mod.TPA-9) • **FR** Bain marie monophasé - Cuve GN 1/1 + GN 1/3 h.15 (inclus 1 Élément de jonction top mod.TPA-9) • **ES BAÑO DE MARÍA MONOFÁSICO - CUBA PARA GN 1/1 + GN 1/3 15H (INCLUIDA 1 CHAPA DE CIERRE PARA TOP MOD.TPA-9) cm. 40x 90x 28h**



2,85 KW 1.921,00
 230V~ 39 / 0,23
 50/60 Hz

BMT-98ET BAGNOMARIA TRIFASE Vasca per GN 2/1 + 2 x GN 1/3 h.15 (inclusa
 19050830 1 testata chiusura piano mod.TPA-9)
EN Bain marie threephase - Bowl for GN 2/1 + 2 x GN 1/3 h.15 (included 1 Head end filler strip mod.TPA-9) • **DE** Wasserbäder dreiphasig - Becken GN 2/1 + 2 x GN 1/3 h.15 (inbegriffen 1 Abschluss-Element mod.TPA-9) • **FR** Bain marie triphase - Cuve GN 2/1 + 2 x GN 1/3 h.15 (inclus 1 Élément de jonction top mod.TPA-9) • **ES BAÑO DE MARÍA TRIFÁSICO - CUBA PARA GN 2/1 + 2 X GN 1/3 H.15 (INCLUIDA 1 CHAPA DE CIERRE PARA TOP MOD.TPA-9) cm. 80x 90x 28h**



5,7 kW 2.745,00
 400V~3N 54 / 0,44
 230V~3
 50/60 Hz

BMT-94G BAGNOMARIA GAS Vasca per GN 1/1 + GN 1/3 h.15 (inclusa 1
 19220450 testata chiusura piano mod.TPA-9)
EN Gas bain-marie - Bowl for GN 1/1 + GN 1/3 h.15 (included 1 Head end filler strip mod.TPA-9) • **DE** Gas Wasserbad - Becken GN 1/1 + GN 1/3 h.15 (inbegriffen 1 Abschluss-Element mod.TPA-9) • **FR** Bain-marie gaz - Cuve pour GN 1/1 + GN 1/3 h.15 (inclus 1 Élément de jonction top mod.TPA-9) • **ES BAÑO DE MARÍA GAS - CUBA PARA GN 1/1 + GN 1/3 15H (INCLUIDA 1 CHAPA DE CIERRE PARA TOP MOD.TPA-9) cm. 40x 90x 28h**



3,5 kW 2.125,00
 3.010 kcal/h 48 / 0,23

BMT-98G BAGNOMARIA GAS Vasca per GN 2/1 + 2 x GN 1/3 h.15 (inclusa 1
 19220850 testata chiusura piano mod.TPA-9)
EN Gas bain-marie - Bowl for GN 2/1 + 2 x GN 1/3 h.15 (included 1 Head end filler strip mod.TPA-9) • **DE** Gas Wasserbad - Becken GN 2/1 + 2 x GN 1/3 h.15 (inbegriffen 1 Abschluss-Element mod.TPA-9) • **FR** Bain-marie gaz - Cuve pour GN 2/1 + 2 x GN 1/3 h.15 (inclus 1 Élément de jonction top mod.TPA-9) • **ES BAÑO DE MARÍA GAS - CUBA PARA GN 2/1 + 2 X GN 1/3 15H (INCLUIDA 1 CHAPA DE CIERRE PARA TOP MOD.TPA-9) cm. 80x 90x 28h**



6,5 kW 3.117,00
 5.590 kcal/h 61 / 0,44

BST-94EM CONTENITORE CALDO CON INFRAROSSO MONOFASE Vasca cm.
 19040410 30,5x51x16,5h con falsofondo forato (inclusa 1 testata chiusura piano mod.TPA-9)
EN Fry dump singlephase with infra-red heater. Bowl cm. 30,5x51x16,5h with perforated double bottom (included 1 Head end filler strip mod.TPA-9) • **DE** Frittenwanne Einphasig mit Infrarot-strahler. Becke cm. 30,5x51x16,5h mit gelochtem Bodenrost (inbegriffen 1 Abschluss-Element mod.TPA-9) • **FR** Silo a frites monophasé avec infrarouge. Cuve cm 30,5x51x16,5h avec double-fond perforé. (inclus 1 Élément de jonction top mod.TPA-9) • **ES CONTENEDOR CALIENTE POR INFRARROJO MONOFÁSICO. CUBA CM. 30,5X51X16,5H CON FALSO FONDO AGUJERADO (INCLUIDA 1 CHAPA DE CIERRE PARA TOP MOD.TPA-9) cm. 40x 90x 28h**



1,47 kW 1.765,00
 230V~ 48 / 0,26
 50/60 Hz

FRY-TOP ELETTRICI - TOP

MOD. _____
COD. _____

DESCRIZIONE/DESCRIPTION/BEZEICHNUNG/DESCRIPTION/DESCRIPCIÓN
DIMENSIONI/DIMENSIONS/ABMESSUNGEN/DIMENSIONS/DIMENSIONES

POTENZA/POWER/LEISTUNG/PUISSANCE/POTENCIA
VOLTAGGIO/VOLTAGE/SPANNUNG/VOLTAGE/VOLTAJE

⚡ kW _____
kcal/h _____
V~ _____
Hz _____

PREZZO/PRICE € _____
PREIS/PRICE/PRECIO _____
KG / M³ _____

FTLT-94ET
19060431 Fry-top elettrico liscio, piastra cm.36x68 (inclusa 1 testata chiusura piano mod.TPA-9)
EN Electric Fry-top smooth griddle, plate cm.36x68 (included 1 Head end filler strip mod.TPA-9) • **DE** Griddleplatte elektrische glatt, platte cm.36x68 (inbegriffen 1 Abschluss-Element mod.TPA-9) • **FR** Plaque électriques lisse, plaque cm.36x68 (inclus 1 Élément de jonction top mod.TPA-9) • **ES FRY-TOP ELÉCTRICO LISO, PLANCHA CM.36X68 (INCLUIDA 1 CHAPA DE CIERRE PARA TOP MOD.TPA-9)**
cm. 40x 90x 28h



⚡ 7,5 kW _____ **2.505,00**
400V~3N _____ 69 / 0,23
50/60 Hz _____

FTLT-94ETS
19060434 Fry-top elettrico liscio cromato SUPERCHROME (Moca Approved), piastra cm.36x68 (inclusa 1 testata chiusura piano mod.TPA-9)
EN Electric Fry-top smooth chromed griddle SUPERCHROME (Moca Approved), plate cm.36x68 (included 1 Head end filler strip mod.TPA-9) • **DE** Griddleplatte elektrische glatt hartverchromt SUPERCHROME (Moca Approved), platte cm.36x68 (inbegriffen 1 Abschluss-Element mod.TPA-9) • **FR** Plaque électriques lisse chromée SUPERCHROME (Moca Approved), plaque cm.36x68 (inclus 1 Élément de jonction top mod.TPA-9) • **ES FRY-TOP ELÉCTRICO LISO CROMADO SUPERCHROME (MOCA APPROVED), PLANCHA CM.36X68 (INCLUIDA 1 CHAPA DE CIERRE PARA TOP MOD.TPA-9)**
cm. 40x 90x 28h

⚡ 7,5 kW _____ **3.138,00**
400V~3N _____ 69 / 0,23
50/60 Hz _____

FTLT-94ETSS
19060430 Fry-top elettrico liscio CROMO LUCIDO, piastra cm.36x68 (inclusa 1 testata chiusura piano mod.TPA-9)
EN Electric Fry-top smooth POLISHED CHROME, plate cm.36x68 (included 1 Head end filler strip mod.TPA-9) • **DE** Griddleplatte elektrische glatt POLIERTEM CHROM, platte cm.36x68 (inbegriffen 1 Abschluss-Element mod.TPA-9) • **FR** Plaque électriques lisse CHROME POLI, plaque cm.36x68 (inclus 1 Élément de jonction top mod.TPA-9) • **ES FRY-TOP ELÉCTRICO LISO CROMO PULIDO, PLANCHA CM.36X68 (INCLUIDA 1 CHAPA DE CIERRE PARA TOP MOD.TPA-9)**
cm. 40x 90x 28h

⚡ 7,5 kW _____ **3.138,00**
400V~3N _____ 69 / 0,23
50/60 Hz _____

FTRT-94ET
19060433 Fry-top elettrico rigato, piastra cm.36x68 (inclusa 1 testata chiusura piano mod.TPA-9)
EN Electric Fry-top grooved griddle, plate cm.36x68 (included 1 Head end filler strip mod.TPA-9) • **DE** Griddleplatte elektrische gerillt, platte cm.36x68 (inbegriffen 1 Abschluss-Element mod.TPA-9) • **FR** Plaque électriques nervurée, plaque cm.36x68 (inclus 1 Élément de jonction top mod.TPA-9) • **ES FRY-TOP ELÉCTRICO ESTRIADO, PLANCHA CM.36X68 (INCLUIDA 1 CHAPA DE CIERRE PARA TOP MOD.TPA-9)**
cm. 40x 90x 28h



⚡ 7,5 kW _____ **2.660,00**
400V~3N _____ 69 / 0,23
50/60 Hz _____

FTRT-94ETS
19060436 Fry-top elettrico rigato cromato SUPERCHROME (Moca Approved), piastra cm.36x68 (inclusa 1 testata chiusura piano mod.TPA-9)
EN Electric Fry-top grooved chromed griddle SUPERCHROME (Moca Approved), plate cm.36x68 (included 1 Head end filler strip mod.TPA-9) • **DE** Griddleplatte elektrische gerillt hartverchromt SUPERCHROME (Moca Approved), platte cm.36x68 (inbegriffen 1 Abschluss-Element mod.TPA-9) • **FR** Plaque électriques nervurée chromée SUPERCHROME (Moca Approved), plaque cm.36x68 (inclus 1 Élément de jonction top mod.TPA-9) • **ES FRY-TOP ELÉCTRICO ESTRIADO CROMADO SUPERCHROME (MOCA APPROVED), PLANCHA CM.36X68 (INCLUIDA 1 CHAPA DE CIERRE PARA TOP MOD.TPA-9)**
cm. 40x 90x 28h

⚡ 7,5 kW _____ **3.292,00**
400V~3N _____ 69 / 0,23
50/60 Hz _____

FTLT-98ET
19060831 Fry-top elettrico liscio, piastra cm.76x68 - 2 zone di cottura (inclusa 1 testata chiusura piano mod.TPA-9)
EN Electric Fry-top smooth griddle, plate cm.76x68 - 2 cooking areas (included 1 Head end filler strip mod.TPA-9) • **DE** Griddleplatte elektrische glatt, platte cm.76x68 - 2 Heizzonen (inbegriffen 1 Abschluss-Element mod.TPA-9) • **FR** Plaque électriques lisse, plaque cm.76x68 - 2 zones de cuisson (inclus 1 Élément de jonction top mod.TPA-9) • **ES FRY-TOP ELÉCTRICO LISO, PLANCHA CM.76X68 - 2 ZONAS DE COCCIÓN (INCLUIDA 1 CHAPA DE CIERRE PARA TOP MOD.TPA-9)**
cm. 80x 90x 28h



⚡ 15 kW _____ **3.710,00**
400V~3N _____ 103 / 0,44
50/60 Hz _____

FRY-TOP ELETTRICI - TOP

MOD. _____ DESCRIZIONE/DESCRIPTION/BEZEICHNUNG/DESCRIPTION/DESCRIPCIÓN POTENZA/POWER/LEISTUNG/PUISSANCE/POTENCIA ⚡ kW ⚡ kW PREZZO/PRICE €
 COD. _____ DIMENSIONI/DIMENSIONS/ABMESSUNGEN/DIMENSIONS/DIMENSIONES VOLTAGGIO/VOLTAGE/SPANNUNG/VOLTAGE/VOLTAJE kcal/h V~ Hz PREIS/PRIX/PRECIO €
 KG / M³

FTLT-98ETS Fry-top elettrico liscio cromato SUPERCHROME (Moca Approved), piastra cm.76x68 - 2 zone di cottura (inclusa 1 testata chiusura piano mod.TPA-9)
EN Electric Fry-top smooth chromed griddle SUPERCHROME (Moca Approved), plate cm.76x68 - 2 cooking areas (included 1 Head end filler strip mod.TPA-9) • **DE** Griddleplatte elektrische glatt hartverchromt SUPERCHROME (Moca Approved), platte cm.76x68 - 2 Heizzonen (inbegriffen 1 Abschluss-Element mod.TPA-9) • **FR** Plaque électriques lisse chromée SUPERCHROME (Moca Approved), plaque cm.76x68 - 2 zones de cuisson (inclus 1 Élément de jonction top mod.TPA-9) • **ES FRY-TOP ELÉCTRICO LISO CROMADO SUPERCHROME (MOCA APPROVED), PLANCHA CM.76X68 - 2 ZONAS DE COCCIÓN (INCLUIDA 1 CHAPA DE CIERRE PARA TOP MOD.TPA-9)**
cm. 80x 90x 28h



⚡ 15 kW **4.554,00**
 400V~3N 103 / 0,44
 50/60 Hz



FTLT-98ETSS Fry-top elettrico liscio CROMO LUCIDO, piastra cm.76x68 - 2 zone di cottura (inclusa 1 testata chiusura piano mod.TPA-9)
EN Electric Fry-top smooth POLISHED CHROME, plate cm.76x68 - 2 cooking areas (included 1 Head end filler strip mod.TPA-9) • **DE** Griddleplatte elektrische glatt POLIERTEM CHROM, platte cm.76x68 - 2 Heizzonen (inbegriffen 1 Abschluss-Element mod.TPA-9) • **FR** Plaque électriques lisse CHROME POLI, plaque cm.76x68 - 2 zones de cuisson (inclus 1 Élément de jonction top mod.TPA-9) • **ES FRY-TOP ELÉCTRICO LISO CROMO PULIDO, PLANCHA CM.76X68 - 2 ZONAS DE COCCIÓN (INCLUIDA 1 CHAPA DE CIERRE PARA TOP MOD.TPA-9)**
cm. 80x 90x 28h

⚡ 15 kW **4.554,00**
 400V~3N 103 / 0,44
 50/60 Hz



FTLRT-98ET Fry-top elettrico 1/2 rigato + 1/2 liscio, piastra cm.76x68 - 2 zone di cottura (inclusa 1 testata chiusura piano mod.TPA-9)
EN Electric Fry-top 1/2 grooved + 1/2 smooth, plate cm.76x68 - 2 cooking areas (included 1 Head end filler strip mod.TPA-9) • **DE** Griddleplatte elektrische 1/2 gerillt + 1/2 glatt, platte cm.76x68 - 2 Heizzonen (inbegriffen 1 Abschluss-Element mod.TPA-9) • **FR** Plaque électriques 1/2 nervurée + 1/2 lisse, plaque cm.76x68 - 2 zones de cuisson (inclus 1 Élément de jonction top mod.TPA-9) • **ES FRY-TOP ELÉCTRICO 1/2 ESTRIADO + 1/2 LISO, PLANCHA CM.76X68 - 2 ZONAS DE COCCIÓN (INCLUIDA 1 CHAPA DE CIERRE PARA TOP MOD.TPA-9)**
cm. 80x 90x 28h



⚡ 15 kW **3.896,00**
 400V~3N 103 / 0,44
 50/60 Hz



FTLRT-98ETS Fry-top elettrico 1/2 rigato + 1/2 liscio cromato SUPERCHROME (Moca Approved), piastra cm.76x68 - 2 zone di cottura (inclusa 1 testata chiusura piano mod.TPA-9)
EN Electric Fry-top 1/2 grooved + 1/2 smooth chromed griddle SUPERCHROME (Moca Approved), plate cm.76x68 - 2 cooking areas (included 1 Head end filler strip mod.TPA-9) • **DE** Griddleplatte elektrische 1/2 gerillt + 1/2 glatt hartverchromt SUPERCHROME (Moca Approved), platte cm.76x68 - 2 Heizzonen (inbegriffen 1 Abschluss-Element mod.TPA-9) • **FR** Plaque électriques 1/2 nervurée + 1/2 lisse chromée SUPERCHROME (Moca Approved), plaque cm.76x68 - 2 zones de cuisson (inclus 1 Élément de jonction top mod.TPA-9) • **ES FRY-TOP ELÉCTRICO 1/2 ESTRIADO + 1/2 LISO CROMADO SUPERCHROME (MOCA APPROVED), PLANCHA CM.76X68 - 2 ZONAS DE COCCIÓN (INCLUIDA 1 CHAPA DE CIERRE PARA TOP MOD.TPA-9)**
cm. 80x 90x 28h



⚡ 15 kW **4.737,00**
 400V~3N 103 / 0,44
 50/60 Hz



FTRT-98ET Fry-top elettrico rigato, piastra cm.76x68 - 2 zone di cottura (inclusa 1 testata chiusura piano mod.TPA-9)
EN Electric Fry-top grooved griddle, plate cm.76x68 - 2 cooking areas (included 1 Head end filler strip mod.TPA-9) • **DE** Griddleplatte elektrische gerillt, platte cm.76x68 - 2 Heizzonen (inbegriffen 1 Abschluss-Element mod.TPA-9) • **FR** Plaque électriques nervurée, plaque cm.76x68 - 2 zones de cuisson (inclus 1 Élément de jonction top mod.TPA-9) • **ES FRY-TOP ELÉCTRICO ESTRIADO, PLANCHA CM.76X68 - 2 ZONAS DE COCCIÓN (INCLUIDA 1 CHAPA DE CIERRE PARA TOP MOD.TPA-9)**
cm. 80x 90x 28h



⚡ 15 kW **4.085,00**
 400V~3N 103 / 0,44
 50/60 Hz



FRY-TOP ELETTRICI - TOP

MOD. _____
COD. _____

DESCRIZIONE/DESCRIPTION/BEZEICHNUNG/DESCRIPTION/DESCRIPCIÓN
DIMENSIONI/DIMENSIONS/ABMESSUNGEN/DIMENSIONS/DIMENSIONES

POTENZA/POWER/LEISTUNG/PUISSANCE/POTENCIA
VOLTAGGIO/VOLTAGE/SPANNUNG/VOLTAGE/VOLTAJE

⚡ kW _____
kcal/h _____
V~ _____
Hz _____

PREZZO/PRICE €
PREIS/PRIX/PRECIO _____
KG / M²

FTRT-98ETS Fry-top elettrico rigato cromato SUPERCHROME (Moca Approved), piastra cm.76x68 - 2 zone di cottura (inclusa 1 testata chiusura piano mod.TPA-9)
EN Electric Fry-top grooved chromed griddle SUPERCHROME (Moca Approved), plate cm.76x68 - 2 cooking areas (included 1 Head end filler strip mod.TPA-9) • **DE** Griddleplatte elektrische gerillt hartverchromt SUPERCHROME (Moca Approved), platte cm.76x68 - 2 Heizzonen (inbegriffen 1 Abschluss-Element mod.TPA-9) • **FR** Plaque électriques nervurée chromée SUPERCHROME (Moca Approved), plaque cm.76x68 - 2 zones de cuisson (inclus 1 Élément de jonction top mod.TPA-9) • **ES FRY-TOP ELÉCTRICO ESTRIADO CROMADO SUPERCHROME (MOCA APPROVED), PLANCHA CM.76X68 - 2 ZONAS DE COCCIÓN (INCLUIDA 1 CHAPA DE CIERRE PARA TOP MOD. TPA-9)**
cm. 80x 90x 28h



⚡ 15 kW **4.920,00**
400V~3N 103 / 0,44
50/60 Hz



FTLT-912ET Fry-top elettrico liscio, piastra cm.110,5x65 - 3 zone di cottura (inclusa 1 testata chiusura piano mod.TPA-9)
EN Electric Fry-top smooth griddle, plate cm.110,5x65 - 3 cooking areas (included 1 Head end filler strip mod.TPA-9) • **DE** Griddleplatte elektrische glatt, platte cm.110,5x65 - 3 Heizzonen (inbegriffen 1 Abschluss-Element mod.TPA-9) • **FR** Plaque électriques lisse, plaque cm.110,5x65 - 3 zones de cuisson (inclus 1 Élément de jonction top mod.TPA-9) • **ES FRY-TOP ELÉCTRICO LISO, PLANCHA CM.110,5X65 - 3 ZONAS DE COCCIÓN (INCLUIDA 1 CHAPA DE CIERRE PARA TOP MOD.TPA-9)**
cm. 120x 90x 28h



⚡ 22,5 kW **6.040,00**
400V~3N 161 / 0,64
50/60 Hz



FTLT-912ETS Fry-top elettrico liscio cromato SUPERCHROME (Moca Approved), piastra cm.110,5x65 - 3 zone di cottura (inclusa 1 testata chiusura piano mod.TPA-9)
EN Electric Fry-top smooth chromed griddle SUPERCHROME (Moca Approved), plate cm.110,5x65 - 3 cooking areas (included 1 Head end filler strip mod.TPA-9) • **DE** Griddleplatte elektrische glatt hartverchromt SUPERCHROME (Moca Approved), platte cm.110,5x65 - 3 Heizzonen (inbegriffen 1 Abschluss-Element mod.TPA-9) • **FR** Plaque électriques lisse chromée SUPERCHROME (Moca Approved), plaque cm.110,5x65 - 3 zones de cuisson (inclus 1 Élément de jonction top mod.TPA-9) • **ES FRY-TOP ELÉCTRICO LISO CROMADO SUPERCHROME (MOCA APPROVED), PLANCHA CM.110,5X65 - 3 ZONAS DE COCCIÓN (INCLUIDA 1 CHAPA DE CIERRE PARA TOP MOD. TPA-9)**
cm. 120x 90x 28h

⚡ 22,5 kW **6.987,00**
400V~3N 161 / 0,64
50/60 Hz



FTLRT-912ET Fry-top elettrico 1/3 rigato + 2/3 liscio, piastra cm.110,5x65 - 3 zone di cottura (inclusa 1 testata chiusura piano mod.TPA-9)
EN Electric Fry-top 1/3 grooved + 2/3 smooth, plate cm.110,5x65 - 3 cooking areas (included 1 Head end filler strip mod.TPA-9) • **DE** Griddleplatte elektrische 1/3 gerillt + 2/3 glatt, platte cm.110,5x65 - 3 Heizzonen (inbegriffen 1 Abschluss-Element mod.TPA-9) • **FR** Plaque électriques 1/3 nervurée + 2/3 lisse, plaque cm.110,5x65 - 3 zones de cuisson (inclus 1 Élément de jonction top mod.TPA-9) • **ES FRY-TOP ELÉCTRICO 1/3 ESTRIADO + 2/3 LISO, PLANCHA CM.110,5X65 - 3 ZONAS DE COCCIÓN (INCLUIDA 1 CHAPA DE CIERRE PARA TOP MOD.TPA-9)**
cm. 120x 90x 28h



⚡ 22,5 kW **6.442,00**
400V~3N 161 / 0,64
50/60 Hz



FTLRT-912ETS Fry-top elettrico 1/3 rigato + 2/3 liscio cromato SUPERCHROME (Moca Approved), piastra cm.110,5x65 - 3 zone di cottura (inclusa 1 testata chiusura piano mod.TPA-9)
EN Electric Fry-top 1/3 grooved + 2/3 smooth chromed griddle SUPERCHROME (Moca Approved), plate cm.110,5x65 - 3 cooking areas (included 1 Head end filler strip mod.TPA-9) • **DE** Griddleplatte elektrische 1/3 gerillt + 2/3 glatt hartverchromt SUPERCHROME (Moca Approved), platte cm.110,5x65 - 3 Heizzonen (inbegriffen 1 Abschluss-Element mod.TPA-9) • **FR** Plaque électriques 1/3 nervurée + 2/3 lisse chromée SUPERCHROME (Moca Approved), plaque cm.110,5x65 - 3 zones de cuisson (inclus 1 Élément de jonction top mod.TPA-9) • **ES FRY-TOP ELÉCTRICO 1/3 ESTRIADO + 2/3 LISO CROMADO SUPERCHROME (MOCA APPROVED), PLANCHA CM.110,5X65 - 3 ZONAS DE COCCIÓN (INCLUIDA 1 CHAPA DE CIERRE PARA TOP MOD.TPA-9)**
cm. 120x 90x 28h

⚡ 22,5 kW **7.388,00**
400V~3N 161 / 0,64
50/60 Hz



FRY-TOP A GAS - TOP

MOD. _____ DESCRIZIONE/DESCRIPTION/BEZEICHNUNG/DESCRIPTION/DESCRIPCIÓN POTENZA/POWER/LEISTUNG/PUISSANCE/POTENCIA $\frac{kW}{kcal/h}$ $\frac{kW}{V-Hz}$ PREZZO/PRICE €
 COD. _____ DIMENSIONI/DIMENSIONS/ABMESSUNGEN/DIMENSIONS/DIMENSIONES VOLTAGGIO/VOLTAGE/SPANNUNG/VOLTAGE/VOLTAJE kcal/h $\frac{kW}{V-Hz}$ PREIS/PRIX/PRECIO €
 KG / M³

FTLT-94G
19230451

Fry-top gas liscio, piastra cm.36x68 (inclusa 1 testata chiusura piano mod.TPA-9)
EN Gas Fry-top smooth griddle, plate cm.36x68 (included 1 Head end filler strip mod.TPA-9) • **DE** Gas-griddleplatte glatt, platte cm.36x68 (inbegriffen 1 Abschluss-Element mod.TPA-9) • **FR** Plaque gaz lisse, plaque cm.36x68 (inclus 1 Élément de jonction top mod.TPA-9) • **ES FRY-TOP GAS LISO, PLANCHA CM.36X68 (INCLUIDA 1 CHAPA DE CIERRE PARA TOP MOD.TPA-9)**
cm. 40x 90x 28h



$\frac{9 kW}{7.7440 kcal/h}$ **2.589,00**
71 / 0,23

FTLT-94GS
19230454

Fry-top gas liscio cromato SUPERCHROME (Moca Approved), piastra cm.36x68 (inclusa 1 testata chiusura piano mod.TPA-9)
EN Gas Fry-top smooth chromed griddle SUPERCHROME (Moca Approved), plate cm.36x68 (included 1 Head end filler strip mod.TPA-9) • **DE** Gas-griddleplatte glatt hartverchromt SUPERCHROME (Moca Approved), platte cm.36x68 (inbegriffen 1 Abschluss-Element mod.TPA-9) • **FR** Plaque gaz lisse chromée SUPERCHROME (Moca Approved), plaque cm.36x68 (inclus 1 Élément de jonction top mod.TPA-9) • **ES FRY-TOP GAS LISO CROMADO SUPERCHROME (MOCA APPROVED), PLANCHA CM.36X68 (INCLUIDA 1 CHAPA DE CIERRE PARA TOP MOD.TPA-9)**
cm. 40x 90x 28h



$\frac{9 kW}{7.7440 kcal/h}$ **3.102,00**
71 / 0,23

FTLT-94GSS
19230450

Fry-top gas liscio CROMO LUCIDO, piastra cm.36x68 (inclusa 1 testata chiusura piano mod.TPA-9)
EN Gas Fry-top smooth POLISHED CHROME, plate cm.36x68 (included 1 Head end filler strip mod.TPA-9) • **DE** Gas-griddleplatte glatt POLIERTEM CHROM, platte cm.36x68 (inbegriffen 1 Abschluss-Element mod.TPA-9) • **FR** Plaque gaz lisse CHROME POLI, plaque cm.36x68 (inclus 1 Élément de jonction top mod.TPA-9) • **ES FRY-TOP GAS LISO CROMO PULIDO, PLANCHA CM.36X68 (INCLUIDA 1 CHAPA DE CIERRE PARA TOP MOD.TPA-9)**
cm. 40x 90x 28h



$\frac{9 kW}{7.7440 kcal/h}$ **3.102,00**
71 / 0,23

FTRT-94G
19230453

Fry-top gas rigato, piastra cm.36x68 (inclusa 1 testata chiusura piano mod.TPA-9)
EN Gas Fry-top grooved griddle, plate cm.36x68 (included 1 Head end filler strip mod.TPA-9) • **DE** Gas-griddleplatte gerillt, platte cm.36x68 (inbegriffen 1 Abschluss-Element mod.TPA-9) • **FR** Plaque gaz nervurée, plaque cm.36x68 (inclus 1 Élément de jonction top mod.TPA-9) • **ES FRY-TOP GAS ESTRIADO, PLANCHA CM.36X68 (INCLUIDA 1 CHAPA DE CIERRE PARA TOP MOD.TPA-9)**
cm. 40x 90x 28h



$\frac{9 kW}{7.7440 kcal/h}$ **2.713,00**
71 / 0,23

FTRT-94GS
19230456

Fry-top gas rigato cromato SUPERCHROME (Moca Approved), piastra cm.36x68 (inclusa 1 testata chiusura piano mod.TPA-9)
EN Gas Fry-top grooved chromed griddle SUPERCHROME (Moca Approved), plate cm.36x68 (included 1 Head end filler strip mod.TPA-9) • **DE** Gas-griddleplatte gerillt hartverchromt SUPERCHROME (Moca Approved), platte cm.36x68 (inbegriffen 1 Abschluss-Element mod.TPA-9) • **FR** Plaque gaz nervurée chromée SUPERCHROME (Moca Approved), plaque cm.36x68 (inclus 1 Élément de jonction top mod.TPA-9) • **ES FRY-TOP GAS ESTRIADO CROMADO SUPERCHROME (MOCA APPROVED), PLANCHA CM.36X68 (INCLUIDA 1 CHAPA DE CIERRE PARA TOP MOD.TPA-9)**
cm. 40x 90x 28h



$\frac{9 kW}{7.7440 kcal/h}$ **3.246,00**
71 / 0,23

FTLT-98G
19230851

Fry-top gas liscio, piastra cm.76x68 - 2 zone di cottura (inclusa 1 testata chiusura piano mod.TPA-9)
EN Gas Fry-top smooth griddle, plate cm.76x68 - 2 cooking areas (included 1 Head end filler strip mod.TPA-9) • **DE** Gas-griddleplatte glatt, platte cm.76x68 - 2 Heizzonen (inbegriffen 1 Abschluss-Element mod.TPA-9) • **FR** Plaque gaz lisse, plaque cm.76x68 - 2 zones de cuisson (inclus 1 Élément de jonction top mod.TPA-9) • **ES FRY-TOP GAS LISO, PLANCHA CM.76X68 - 2 ZONAS DE COCCIÓN (INCLUIDA 1 CHAPA DE CIERRE PARA TOP MOD.TPA-9)**
cm. 80x 90x 28h



$\frac{18 kW}{15.480 kcal/h}$ **3.970,00**
108 / 0,44

FRY-TOP A GAS - TOP

MOD. _____
COD. _____

DESCRIZIONE/DESCRIPTION/BEZEICHNUNG/DESCRIPTION/DESCRIPCIÓN
DIMENSIONI/DIMENSIONS/ABMESSUNGEN/DIMENSIONS/DIMENSIONES

POTENZA/POWER/LEISTUNG/PUISSANCE/POTENCIA
VOLTAGGIO/VOLTAGE/SPANNUNG/VOLTAGE/VOLTAJE

18 kW
15.480 kcal/h

PREZZO/PRICE
PREIS/PRIX/PRECIO €
KG / M³

FTLT-98GS
19230854

Fry-top gas liscio cromato SUPERCHROME (Moca Approved), piastra cm.76x68 - 2 zone di cottura (inclusa 1 testata chiusura piano mod.TPA-9)
EN Gas Fry-top smooth chromed griddle SUPERCHROME (Moca Approved), plate cm.76x68 - 2 cooking areas (included 1 Head end filler strip mod.TPA-9) • **DE** Gas-griddleplatte glatt hartverchromt SUPERCHROME (Moca Approved), platte cm.76x68 - 2 Heizzonen (inbegriffen 1 Abschluss-Element mod.TPA-9) • **FR** Plaque gaz lisse chromée SUPERCHROME (Moca Approved), plaque cm.76x68 - 2 zones de cuisson (inclus 1 Élément de jonction top mod.TPA-9) • **ES FRY-TOP GAS LISO CROMADO SUPERCHROME (MOCA APPROVED), PLANCHA CM.76X68 - 2 ZONAS DE COCCIÓN (INCLUIDA 1 CHAPA DE CIERRE PARA TOP MOD.TPA-9)**
cm. 80x 90x 28h



18 kW
15.480 kcal/h

4.939,00
108 / 0,44

FTLT-98GS5
19230850

Fry-top gas liscio CROMO LUCIDO, piastra cm.76x68 - 2 zone di cottura (inclusa 1 testata chiusura piano mod.TPA-9)
EN Gas Fry-top smooth POLISHED CHROME, plate cm.76x68 - 2 cooking areas (included 1 Head end filler strip mod.TPA-9) • **DE** Gas-griddleplatte glatt POLIERTEM CHROM, platte cm.76x68 - 2 Heizzonen (inbegriffen 1 Abschluss-Element mod.TPA-9) • **FR** Plaque gaz lisse CHROME POLI, plaque cm.76x68 - 2 zones de cuisson (inclus 1 Élément de jonction top mod.TPA-9) • **ES FRY-TOP GAS LISO CROMO PULIDO, PLANCHA CM.76X68 - 2 ZONAS DE COCCIÓN (INCLUIDA 1 CHAPA DE CIERRE PARA TOP MOD.TPA-9)**
cm. 80x 90x 28h

18 kW
15.480 kcal/h

4.939,00
108 / 0,44

FTLRT-98G
19230852

Fry-top gas 1/2 rigato + 1/2 liscio, piastra cm.76x68 - 2 zone di cottura (inclusa 1 testata chiusura piano mod.TPA-9)
EN Gas Fry-top 1/2 grooved + 1/2 smooth, plate cm.76x68 - 2 cooking areas (included 1 Head end filler strip mod.TPA-9) • **DE** Gas-griddleplatte 1/2 gerillt + 1/2 glatt, platte cm.76x68 - 2 Heizzonen (inbegriffen 1 Abschluss-Element mod.TPA-9) • **FR** Plaque gaz 1/2 nervurée + 1/2 lisse, plaque cm.76x68 - 2 zones de cuisson (inclus 1 Élément de jonction top mod.TPA-9) • **ES FRY-TOP GAS 1/2 ESTRIADO + 1/2 LISO, PLANCHA CM.76X68 - 2 ZONAS DE COCCIÓN (INCLUIDA 1 CHAPA DE CIERRE PARA TOP MOD.TPA-9)**
cm. 80x 90x 28h



18 kW
15.480 kcal/h

4.155,00
108 / 0,44

FTLRT-98GS
19230855

Fry-top gas 1/2 rigato + 1/2 liscio cromato SUPERCHROME (Moca Approved), piastra cm.76x68 - 2 zone di cottura (inclusa 1 testata chiusura piano mod.TPA-9)
EN Gas Fry-top 1/2 grooved + 1/2 smooth chromed griddle SUPERCHROME (Moca Approved), plate cm.76x68 - 2 cooking areas (included 1 Head end filler strip mod.TPA-9) • **DE** Gas-griddleplatte 1/2 gerillt + 1/2 glatt hartverchromt SUPERCHROME (Moca Approved), platte cm.76x68 - 2 Heizzonen (inbegriffen 1 Abschluss-Element mod.TPA-9) • **FR** Plaque gaz 1/2 nervurée + 1/2 lisse chromée SUPERCHROME (Moca Approved), plaque cm.76x68 - 2 zones de cuisson (inclus 1 Élément de jonction top mod.TPA-9) • **ES FRY-TOP GAS 1/2 ESTRIADO + 1/2 LISO CROMADO SUPERCHROME (MOCA APPROVED), PLANCHA CM.76X68 - 2 ZONAS DE COCCIÓN (INCLUIDA 1 CHAPA DE CIERRE PARA TOP MOD.TPA-9)**
cm. 80x 90x 28h

18 kW
15.480 kcal/h

5.128,00
108 / 0,44

FTRT-98G
19230853

Fry-top gas rigato, piastra cm.76x68 - 2 zone di cottura (inclusa 1 testata chiusura piano mod.TPA-9)
EN Gas Fry-top grooved griddle, plate cm.76x68 - 2 cooking areas (included 1 Head end filler strip mod.TPA-9) • **DE** Gas-griddleplatte gerillt, platte cm.76x68 - 2 Heizzonen (inbegriffen 1 Abschluss-Element mod.TPA-9) • **FR** Plaque gaz nervurée, plaque cm.76x68 - 2 zones de cuisson (inclus 1 Élément de jonction top mod.TPA-9) • **ES FRY-TOP GAS ESTRIADO, PLANCHA CM.76X68 - 2 ZONAS DE COCCIÓN (INCLUIDA 1 CHAPA DE CIERRE PARA TOP MOD.TPA-9)**
cm. 80x 90x 28h



18 kW
15.480 kcal/h

4.337,00
108 / 0,44

FRY-TOP A GAS - TOP

MOD. _____ DESCRIZIONE/DESCRIPTION/BEZEICHNUNG/DESCRIPTION/DESCRIPCIÓN POTENZA/POWER/LEISTUNG/PUISSANCE/POTENCIA $\frac{kW}{kcal/h}$ $\frac{kW}{V-}$ $\frac{Hz}{-$ PREZZO/PRICE € $\frac{KG}{M^3}$
 COD. _____ DIMENSIONI/DIMENSIONS/ABMESSUNGEN/DIMENSIONS/DIMENSIONES VOLTAGGIO/VOLTAGE/SPANNUNG/VOLTAGE/VOLTAJE

FTRT-98GS Fry-top gas rigato cromato SUPERCHROME (Moca Approved), piastra cm.76x68 - 2 zone di cottura (inclusa 1 testata chiusura piano mod.TPA-9)
 19230856 **EN** Gas Fry-top grooved chromed griddle SUPERCHROME (Moca Approved), plate cm.76x68 - 2 cooking areas (included 1 Head end filler strip mod.TPA-9) • **DE** Gas-griddleplatte gerillt hartverchromt SUPERCHROME (Moca Approved), platte cm.76x68 - 2 Heizzonen (inbegriffen 1 Abschluss-Element mod.TPA-9) • **FR** Plaque gaz nervurée chromée SUPERCHROME (Moca Approved), plaque cm.76x68 - 2 zones de cuisson (inclus 1 Élément de jonction top mod.TPA-9) • **ES FRY-TOP GAS ESTRIADO CROMADO SUPERCHROME (MOCA APPROVED), PLANCHA CM.76X68 - 2 ZONAS DE COCCIÓN (INCLUIDA 1 CHAPA DE CIERRE PARA TOP MOD.TPA-9)**
cm. 80x 90x 28h



18 kW **5.321,00**
 15.480 kcal/h 108 / 0,44



FTLT-912G Fry-top gas liscio, piastra cm.110,5x65 - 3 zone di cottura (inclusa 1 testata chiusura piano mod.TPA-9)
 1923125B **EN** Gas Fry-top smooth griddle, plate cm.110,5x65 - 3 cooking areas (included 1 Head end filler strip mod.TPA-9) • **DE** Gas-griddleplatte glatt, platte cm.110,5x65 - 3 Heizzonen (inbegriffen 1 Abschluss-Element mod.TPA-9) • **FR** Plaque gaz lisse, plaque cm.110,5x65 - 3 zones de cuisson (inclus 1 Élément de jonction top mod.TPA-9) • **ES FRY-TOP GAS LISO, PLANCHA CM.110,5X65 - 3 ZONAS DE COCCIÓN (INCLUIDA 1 CHAPA DE CIERRE PARA TOP MOD.TPA-9)**
cm. 120x 90x 28h



27 kW **6.462,00**
 23.220 kcal/h 173 / 0,64



FTLT-912GS Fry-top gas liscio cromato SUPERCHROME (Moca Approved), piastra cm.110,5x65 - 3 zone di cottura (inclusa 1 testata chiusura piano mod.TPA-9)
 1923125E **EN** Gas Fry-top smooth chromed griddle SUPERCHROME (Moca Approved), plate cm.110,5x65 - 3 cooking areas (included 1 Head end filler strip mod.TPA-9) • **DE** Gas-griddleplatte glatt hartverchromt SUPERCHROME (Moca Approved), platte cm.110,5x65 - 3 Heizzonen (inbegriffen 1 Abschluss-Element mod.TPA-9) • **FR** Plaque gaz lisse chromée SUPERCHROME (Moca Approved), plaque cm.110,5x65 - 3 zones de cuisson (inclus 1 Élément de jonction top mod.TPA-9) • **ES FRY-TOP GAS LISO CROMADO SUPERCHROME (MOCA APPROVED), PLANCHA CM.110,5X65 - 3 ZONAS DE COCCIÓN (INCLUIDA 1 CHAPA DE CIERRE PARA TOP MOD.TPA-9)**
cm. 120x 90x 28h

27 kW **7.400,00**
 23.220 kcal/h 173 / 0,64



FTLRT-912G Fry-top gas 1/3 rigato + 2/3 liscio, piastra cm.110,5x65 - 3 zone di cottura (inclusa 1 testata chiusura piano mod.TPA-9)
 1923125C **EN** Gas Fry-top 1/3 grooved + 2/3 smooth, plate cm.110,5x65 - 3 cooking areas (included 1 Head end filler strip mod.TPA-9) • **DE** Gas-griddleplatte 1/3 gerillt + 2/3 glatt, platte cm.110,5x65 - 3 Heizzonen (inbegriffen 1 Abschluss-Element mod.TPA-9) • **FR** Plaque gaz 1/3 nervurée + 2/3 lisse, plaque cm.110,5x65 - 3 zones de cuisson (inclus 1 Élément de jonction top mod.TPA-9) • **ES FRY-TOP GAS 1/3 ESTRIADO + 2/3 LISO, PLANCHA CM.110,5X65 - 3 ZONAS DE COCCIÓN (INCLUIDA 1 CHAPA DE CIERRE PARA TOP MOD.TPA-9)**
cm. 120x 90x 28h



27 kW **6.861,00**
 23.220 kcal/h 173 / 0,64



FTLRT-912GS Fry-top gas 1/3 rigato + 2/3 liscio cromato SUPERCHROME (Moca Approved), piastra cm.110,5x65 - 3 zone di cottura (inclusa 1 testata chiusura piano mod.TPA-9)
 1923125F **EN** Gas Fry-top 1/3 grooved + 2/3 smooth chromed SUPERCHROME (Moca Approved), plate cm.110,5x65 - 3 cooking areas (included 1 Head end filler strip mod.TPA-9) • **DE** Gas-griddleplatte 1/3 gerillt + 2/3 glatt hartverchromt SUPERCHROME (Moca Approved), platte cm.110,5x65 - 3 Heizzonen (inbegriffen 1 Abschluss-Element mod.TPA-9) • **FR** Plaque gaz 1/3 nervurée + 2/3 lisse chromée AW770:AW833pproved), plaque cm.110,5x65 - 3 zones de cuisson (inclus 1 Élément de jonction top mod.TPA-9) • **ES FRY-TOP GAS 1/3 ESTRIADO + 2/3 LISO CROMADO SUPERCHROME (MOCA APPROVED), PLANCHA CM.110,5X65 - 3 ZONAS DE COCCIÓN (INCLUIDA 1 CHAPA DE CIERRE PARA TOP MOD.TPA-9)**
cm. 120x 90x 28h

27 kW **7.798,00**
 23.220 kcal/h 173 / 0,64



GRIGLIE ELETTRICHE - TOP

MOD. _____
COD. _____

DESCRIZIONE/DESCRIPTION/BEZEICHNUNG/DESCRIPTION/DESCRIPCIÓN
DIMENSIONI/DIMENSIONS/ABMESSUNGEN/DIMENSIONS/DIMENSIONES

POTENZA/POWER/LEISTUNG/PUISSANCE/POTENCIA ⚡ kW ⚡ kw ⚡ PREZZO/PRICE €
VOLTAGGIO/VOLTAGE/SPANNUNG/VOLTAGE/VOLTAJE kcal/h V- Hz PREIS/PRIX/PRECIO KG / M³

CWKT-94ET 19080431 GRIGLIA CONTACT - cottura diretta su resistenza in acciaio inox cm. 27x63 ribaltabile (inclusa 1 testata chiusura piano mod.TPA-9)
EN CONTACT Grill threephase - rotatable stainless steel grill cm. 27x63 (included 1 Head end filler strip mod.TPA-9) • **DE** Wurstbrater dreiphasig KONTAKT - Drehbaren Heizelement aus Edelstahl cm. 27x63 (inbegriffen 1 Abschluss-Element mod.TPA-9) • **FR** Grillade triphase CONTACT - Grille inox rotatif cm 27x63 (inclus 1 Élément de jonction top mod.TPA-9) • **ES PARRILLA TRIFÁSICO CONTACT - PARRILLA GIRATORIA DE ACERO INOX CM 27X63 (INCLUIDA 1 CHAPA DE CIERRE PARA TOP MOD.TPA-9)**
cm. 40x 90x 28h



⚡ 5,415 kW **3.434,00**
400V~3N 55 / 0,23
50/60 Hz

CWKT-98ET 19080831 GRIGLIA CONTACT - cottura diretta su resistenza in acciaio inox cm. 55x63 ribaltabile - 2 zone cottura (inclusa 1 testata chiusura piano mod.TPA-9)
EN CONTACT Grill threephase - rotatable stainless steel grill cm. 55x63 - 2 cooking areas (included 1 Head end filler strip mod.TPA-9) • **DE** Wurstbrater dreiphasig KONTAKT - Drehbaren Heizelement aus Edelstahl cm. 55x63 - 2 Heizzonen (inbegriffen 1 Abschluss-Element mod.TPA-9) • **FR** Grillade triphase CONTACT - Grille inox rotatif cm 55x63 - 2 zones de cuisson (inclus 1 Élément de jonction top mod.TPA-9) • **ES PARRILLA TRIFÁSICO CONTACT - PARRILLA GIRATORIA DE ACERO INOX CM 55X63 - 2 ZONAS DE COCCIÓN (INCLUIDA 1 CHAPA DE CIERRE PARA TOP MOD.TPA-9)**
cm. 80x 90x 28h



⚡ 10,83 kW **4.787,00**
400V~3N 85 / 0,44
50/60 Hz

CWT-94ET 19080430 GRIGLIA TRIFASE Griglia in acciaio inox cm. 38x66 regolabile (inclusa 1 testata chiusura piano mod.TPA-9)
EN Grill threephase - Stainless steel grill cm. 38x66 (included 1 Head end filler strip mod.TPA-9) • **DE** Wurstbrater dreiphasig - Einstellbarer Rost aus Nirosta cm. 38x66 (inbegriffen 1 Abschluss-Element mod.TPA-9) • **FR** Grillade triphase - Grille inox cm 38x66 (inclus 1 Élément de jonction top mod.TPA-9) • **ES PARRILLA TRIFÁSICO - PARRILLA DE ACERO INOX REGULABLE CM 38X66 (INCLUIDA 1 CHAPA DE CIERRE PARA TOP MOD.TPA-9)**
cm. 40x 90x 28h



⚡ 7,8 kW **2.662,00**
400V~3N 57 / 0,26
50/60 Hz

CWT-98ET 19080830 GRIGLIA TRIFASE N. 2 griglie in acciaio inox cm. 38x66 regolabili 2 zone di cottura (inclusa 1 testata chiusura piano mod.TPA-9)
EN Grill threephase - N. 2 Stainless steel grill cm. 38x66. 2 cooking areas (included 1 Head end filler strip mod.TPA-9) • **DE** Wurstbrater dreiphasig - N. 2 einstellbare Roste aus Nirosta cm. 38x66 - 2 Heizzonen (inbegriffen 1 Abschluss-Element mod.TPA-9) • **FR** Grillade triphase - N. 2 grilles réglables en acier inox cm. 38x66 - 2 zones de cuisson (inclus 1 Élément de jonction top mod.TPA-9) • **ES PARRILLA TRIFÁSICO - N. 2 PARRILLAS DE ACERO INOX REGULABLE CM 38X66 - 2 ZONAS DE COCCIÓN (INCLUIDA 1 CHAPA DE CIERRE PARA TOP MOD.TPA-9)**
cm. 80x 90x 28h



⚡ 15,6 kW **4.051,00**
400V~3N 87 / 0,51
50/60 Hz

CWT-94G 19250450 GRIGLIA GAS-PIETRALAVICA Griglia in acciaio inox cm. 38x66 regolabile (inclusa 1 testata chiusura piano mod.TPA-9)
EN Charcoal grill gas - Stainless steel grill cm. 38x66 (included 1 Head end filler strip mod.TPA-9) • **DE** Gas-Lavasteingrill - Einstellbarer Rost aus Nirosta cm. 38x66 (inbegriffen 1 Abschluss-Element mod.TPA-9) • **FR** Grille à gaz en pierre de lave - Grille inox cm 38x66 (inclus 1 Élément de jonction top mod.TPA-9) • **ES PARRILLA A GAS PIEDRA LÁVICA - PARRILLA DE ACERO INOX REGULABLE CM 38X66 (INCLUIDA 1 CHAPA DE CIERRE PARA TOP MOD.TPA-9)**
cm. 40x 90x 28h



⚡ 12 kW **2.759,00**
10.320 kcal/h 56 / 0,26

GRIGLIE PIETRA LAVICA A GAS - TOP

MOD. _____ DESCRIZIONE/DESCRIPTION/BEZEICHNUNG/DESCRIPTION/DESCRIPCIÓN POTENZA/POWER/LEISTUNG/PUISSANCE/POTENCIA ⚡ kW ⚡ kW PREZZO/PRICE €
 COD. _____ DIMENSIONI/DIMENSIONS/ABMESSUNGEN/DIMENSIONS/DIMENSIONES VOLTAGGIO/VOLTAGE/SPANNUNG/VOLTAGE/VOLTAJE kcal/h kcal/h V~ Hz PREIS/PRIX/PRECIO €
 KG / M³

CWT-98G
19250850

GRIGLIA GAS-PIETRALAVICA N. 2 griglie in acciaio inox cm. 38x66 regolabili 2 zone di cottura (inclusa 1 testata chiusura piano mod.TPA-9)
EN Charcoal grill gas - N. 2 Stainless steel grill cm. 38x66 2 cooking areas (included 1 Head end filler strip mod.TPA-9) • **DE** Gas-Lavasteingrill - N. 2 einstellbare Roste aus Nirosta cm. 38x66 - 2 Heizzonen (inbegriffen 1 Abschluss-Element mod.TPA-9) • **FR** Grille a gaz en pierre de lave - N. 2 grilles réglables en acier inox cm. 38x66 - 2 zones de cuisson (inclus 1 Elément de jonction top mod.TPA-9)
ES PARRILLA A GAS PIEDRA LÁVICA - N. 2 PARRILLAS DE ACERO INOX REGULABLE CM 38X66 - 2 ZONAS DE COCCIÓN (INCLUIDA 1 CHAPA DE CIERRE PARA TOP MOD. TPA-9)
cm. 80x 90x 28h



⚡ 24 kW
20.640 kcal/h

4.287,00
97 / 0,51

F2/8T-94ET
19090432

FRIGGITRICE TRIFASE LT. 8+8 2 Vasche cm. 14,8x35,5x22,5h - 2 cesti cm. 12x29x11,5h - Filtro e coperchio vasca. Produzione patate: 12 kg/h (inclusa 1 testata chiusura piano mod.TPA-9)
EN Fryer threephase 8+8 lts - 2 Bowls cm. 14,8x35,5x22,5h - 2 baskets cm. 12x29x11,5h. Sieve and lid for pan. Production: 12 kg/h (included 1 Head end filler strip mod.TPA-9) • **DE** Friteuse dreiphasig lt. 8+8 - 2 Becken cm. 14,8x35,5x22,5h - 2 Korb cm. 12x29x11,5h. Einlegesieb und Deckel für Becken. Pommes frites: 12 kg/h (inbegriffen 1 Abschluss-Element mod.TPA-9) • **FR** Friteuse triphase lt. 8+8 - 2 Cuve cm. 14,8x35,5x22,5h - 2 Panier cm. 12x29x11,5h. Filtre, couvercle pour cuve. Production de pommes frites: 12 kg/h (inclus 1 Elément de jonction top mod.TPA-9) • **ES FREIDORAS TRIFÁSICO 8+8 LT. - 2CUBA CM. 14,8X35,5X22,5H- 2 CESTA CM. 12X29X11,5H. FILTRO Y TAPA PARA CUBA. PROD. PATATAS: 12 KG/H (INCLUIDA 1 CHAPA DE CIERRE PARA TOP MOD.TPA-9)**
cm. 40x 90x 28h



⚡ 12 kW
400V~3N
230V~3
50/60 Hz

3.958,00
58 / 0,23

F13T-94ET
19090430

FRIGGITRICE TRIFASE LT. 13 Vasca cm. 30,5x34x22,5h - 1 cesto cm. 28x29x10h Filtro e coperchio vasca - Produzione patate: 10 kg/h (inclusa 1 testata chiusura piano mod.TPA-9)
EN Fryer threephase 13 lts - Bowl cm. 30,5x34x22,5h 1 basket cm. 28x29x10h - Sieve and lid for pan Production: 10 kg/h (included 1 Head end filler strip mod.TPA-9) • **DE** Friteuse dreiphasig lt. 13 - Becken cm. 30,5x34x22,5h - 1 Korb cm. 28x29x10h - Einlegesieb und Deckel für Becken - Pommes frites: 10 kg/h (inbegriffen 1 Abschluss-Element mod.TPA-9) • **FR** Friteuse triphase lt. 13 - Cuve cm. 30,5x34x22,5h - 1 Panier cm. 28x29x10h - Filtre, couvercle pour cuve Production de pommes frites: 10 kg/h (inclus 1 Elément de jonction top mod.TPA-9) • **ES FREIDORAS TRIFÁSICO 13 LT. - CUBA CM. 30,5X34X22,5H - 1 CESTA CM. 28X29X10H - FILTRO Y TAPA PARA CUBA. PROD. PATATAS: 10 KG/H (INCLUIDA 1 CHAPA DE CIERRE PARA TOP MOD.TPA-9)**
cm. 40x 90x 28h



⚡ 10,95 kW
400V~3N
50/60 Hz

3.038,00
55 / 0,23

F2/13T-98ET
19090830

FRIGGITRICE TRIFASE LT. 13+13 2 vasche cm. 30,5x34x22,5h - 2 cesti cm. 28x29x10h 2 filtri e coperchi vasche - Produzione patate: 20 kg/h (inclusa 1 testata chiusura piano mod.TPA-9)
EN Fryer threephase 13+13 lts - 2 pans cm. 30,5x34x22,5h 2 baskets cm. 28x29x10h - 2 sieves and lids for pan Production: 20 kg/h (included 1 Head end filler strip mod.TPA-9) • **DE** Friteuse dreiphasig lt. 13+13 - 2 Becken cm. 30,5x34x22,5h 2 Körbe cm. 28x29x10h - Einlegesieb und Deckel für Becken - Pommes frites: 20 kg/h (inbegriffen 1 Abschluss-Element mod.TPA-9) • **FR** Friteuse triphase lt. 13+13 - 2 cuves cm. 30,5x34x22,5h 2 paniers cm. 28x29x10h - 2 filtres, couvercles pour cuve Production de pommes frites: 20 kg/h (inclus 1 Elément de jonction top mod.TPA-9) • **ES FREIDORAS TRIFÁSICO 13+13 LT. - 2 CUBAS CM. 30,5X34X22,5H - 2 CESTAS CM. 28X29X10H - 2 FILTROS Y TAPAS PARA CUBAS PROD. PATATAS: 20 KG/H (INCLUIDA 1 CHAPA DE CIERRE PARA TOP MOD.TPA-9)**
cm. 80x 90x 28h



⚡ 21,9 kW
400V~3N
50/60 Hz

4.415,00
75 / 0,44

FRIGGITRICI A GAS - TOP

MOD. _____
COD. _____

DESCRIZIONE/DESCRIPTION/BEZEICHNUNG/DESCRIPTION/DESCRIPCIÓN
DIMENSIONI/DIMENSIONS/ABMESSUNGEN/DIMENSIONS/DIMENSIONES

POTENZA/POWER/LEISTUNG/PUISSANCE/POTENCIA
VOLTAGGIO/VOLTAGE/SPANNUNG/VOLTAGE/VOLTAJE

⚡ kW
kcal/h

PREZZO/PRICE €
PREIS/PRIX/PRECIO
KG / M³

F2/8T-94G
19260452

FRIGGITRICE GAS LT. 8+8 - 2 vasche cm. 15x35x23h 2 cestri cm. 12x30x9,5h. Filtro e coperchio vasca. Prod. patate: 12 kg/h (inclusa 1 testata chiusura piano mod.TPA-9)
EN Gas Fryer 8+8 lts - 2 pans cm. 15x35x23h 2 baskets cm. 12x30x9,5h. Sieve and lid for pan. Production: 12 kg/h (included 1 Head end filler strip mod.TPA-9) • **DE** Gas-Friteuse lt. 8+8 - 2 Becken cm. 15x35x23h 2 Körbe cm. 12x30x9,5h. Einlegesieb und Deckel für Becken. Pommes frites: 12 kg/h (inbegriffen 1 Abschluss-Element mod.TPA-9) • **FR** Friteuse à gaz lt. 8+8 - 2 cuves cm. 15x35x23h 2 paniers cm. 12x30x9,5h. Filtre, couvercle pour cuve. Production de pommes frites: 12 kg/h (inclus 1 Élément de jonction top mod.TPA-9) • **ES FREIDORAS A GAS 8+8 LT. - 2 CUBAS CM. 15X35X23H 2 CESTAS CM. 12X30X9,5H. FILTRO Y TAPA PARA CUBA. PROD. PATATAS: 12 KG/H (INCLUIDA 1 CHAPA DE CIERRE PARA TOP MOD. TPA-9)**
cm. 40x 90x 28h



⚡ 9 kW
7.740 kcal/h

4.640,00
58 / 0,23

F13T-94G
19260450

FRIGGITRICE GAS LT. 13 - Vasca cm. 31,5x34,5x22,5h 1 cesto cm. 28x29x10h - Filtro e coperchio vasca. Prod. patate: 10 kg/h (inclusa 1 testata chiusura piano mod.TPA-9)
EN Gas Fryer 13 lts - Bowl cm. 31,5x34,5x22,5h - 1 basket cm. 28x29x10h - Sieve and lid for pan Production: 10 kg/h (included 1 Head end filler strip mod.TPA-9) • **DE** Gas-Friteuse lt. 13 - Becken cm. 31,5x34,5x22,5h - 1 Korb cm. 28x29x10h - Einlegesieb und Deckel für Becken - Pommes frites: 10 kg/h (inbegriffen 1 Abschluss-Element mod.TPA-9) • **FR** Friteuse à gaz lt. 13 - Cuve cm. 31,5x34,5x22,5h - 1 Panier cm. 28x29x10h - Filtre, couvercle pour cuve Production de pommes frites: 10 kg/h (inclus 1 Élément de jonction top mod.TPA-9) • **ES FREIDORAS A GAS 13 LT. - CUBA CM. 31,5X34,5X22,5H - 1 CESTA CM. 28X29X10H - FILTRO Y TAPA PARA CUBA PROD. PATATAS: 10 KG/H (INCLUIDA 1 CHAPA DE CIERRE PARA TOP MOD.TPA-9)**
cm. 40x 90x 28h



⚡ 12 kW
10.320 kcal/h

3.390,00
60 / 0,23

F2/13T-98G
19260850

FRIGGITRICE GAS LT. 13+13 2 vasche cm. 31,5x34,5x22,5h - 2 cestri cm. 28x29x10h 2 filtri e coperchi vasche - Prod. patate: 20 kg/h (inclusa 1 testata chiusura piano mod.TPA-9)
EN Gas Fryer 13+13 lts - 2 pans cm. 31,5x34,5x22,5h 2 baskets cm. 28x29x10h - 2 sieves and lids for pan Production: 20 kg/h (included 1 Head end filler strip mod.TPA-9) • **DE** Gas-Friteuse lt. 13+13 - 2 Becken cm. 31,5x34,5x22,5h 2 Körbe cm. 28x29x10h - Einlegesieb und Deckel für Becken - Pommes frites: 20 kg/h (inbegriffen 1 Abschluss-Element mod.TPA-9) • **FR** Friteuse à gaz lt. 13+13 - 2 cuves cm. 31,5x34,5x22,5h 2 paniers cm. 28x29x10h - 2 filtres, couvercles pour cuve Production de pommes frites: 20 kg/h (inclus 1 Élément de jonction top mod.TPA-9) • **ES FREIDORAS A GAS 13+13 LT. - 2 CUBAS CM. 31,5X34,5X22,5H 2 CESTAS CM. 28X29X10H - 2 FILTROS Y TAPAS PARA CUBAS. PROD. PATATAS: 20 KG/H (INCLUIDA 1 CHAPA DE CIERRE PARA TOP MOD.TPA-9)**
cm. 80x 90x 28h



⚡ 24 kW
20.640 kcal/h

5.400,00
81 / 0,44

MFV-98ET
09490830

Base con Forno elettrico ventilato cm. 55x36x34h, temp: 50÷300°C, con 1 griglia cm.53x32,5 GN1/1 (non sovrapporre elementi ad induzione)
EN Stand with electric fan oven cm. 55x36x34h, temp: 50÷300°C, with 1 grid cm.53x32,5 GN1/1 (no induction top) • **DE** unterbau mit Elektro-Heißluftofen cm. 55x36x34h, temp: 50÷300°C, mit 1 Rost cm.53x32,5 GN1/1 (nicht Induktions) • **FR** placard avec Four à chaleur tournante électrique cm. 55x36x34h, temp: 50÷300°C, avec 1 grille cm.53x32,5 GN1/1 (il faut pas de induction) • **ES MUEBLE CON HORNO ELÉCTRICO VENTILADO CM. 55X36X34H, TEMP: 50÷300 °C, CON 1 PARILLA CM.53X32,5 GN1/1 (NO INDUCCIÓN)**
cm. 80x 83x 57h



⚡ 5,32 kW
400V~3N
230V~3
50/60 Hz

4.206,00
80 / 0,62

CMF-98
09490800

COPERCHIO per MFV-98E
EN Lid for MFV-98E • **DE** Berichterstattung für MFV-98E • **FR** Couvercle pour MFV-98E • **ES CUBERTURA PARA MFV-98E**
cm. 80x 82,5x 2,8h

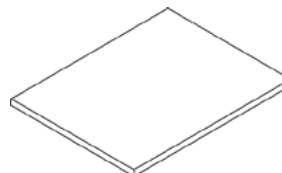

299,00
6 / 0,04

MOBILI BASE

MOD. _____ DESCRIZIONE/DESCRIPTION/BEZEICHNUNG/DESCRIPTION/DESCRIPCIÓN POTENZA/POWER/LEISTUNG/PUISSANCE/POTENCIA ⚡kW ⚡kw PREZZO/PRICE €
 COD. _____ DIMENSIONI/DIMENSIONS/ABMESSUNGEN/DIMENSIONS/DIMENSIONES VOLTAGGIO/VOLTAGE/SPANNUNG/VOLTAGE/VOLTAJE kcal/h V~ KG / M³
 Hz

MPI-94
09410403
BASE CON PORTA PER INDUZIONE
EN Stand with door for induction top • **DE** Unterbau für Induktions mit Tür • **FR** Placard pour induction avec porte • **ES MUEBLE BASE PARA INDUCCIÓN CON PUERTA**
cm. 40x 81x 57h



869,00
22 / 0,26

MPI-98
09410803
cm. 80x 81x 57h



1.004,00
29 / 0,51

M-92
09410200
BASE NEUTRA
EN Stand • **DE** Unterbau • **FR** Placard • **ES MUEBLE BASE**
cm. 20x 78,5x 57h



561,00
14 / 0,25

M-93
09410300
BASE NEUTRA a giorno
EN Open Stand • **DE** Offener Unterbau • **FR** Placard ouvert • **ES MUEBLE BASE ABIERTO**
cm. 30x 78,5x 57h



542,00
16 / 0,26

M-94
09410400
cm. 40x 78,5x 57h



596,00
19 / 0,26

M-96
09410600
cm. 60x 78,5x 57h



680,00
23 / 0,51

M-98
09410800
cm. 80x 78,5x 57h



731,00
26 / 0,51

M-912
09411200
cm. 120x 78,5x 57h



977,00
38 / 0,75

ACCESSORI TOP

MOD. _____ DESCRIZIONE/DESCRIPTION/BEZEICHNUNG/DESCRIPTION/DESCRIPCIÓN POTENZA/POWER/LEISTUNG/PUISSANCE/POTENCIA ⚡kW ⚡kw PREZZO/PRICE €
 COD. _____ DIMENSIONI/DIMENSIONS/ABMESSUNGEN/DIMENSIONS/DIMENSIONES VOLTAGGIO/VOLTAGE/SPANNUNG/VOLTAGE/VOLTAJE kcal/h kcal/h V~ Hz PREIS/PRIX/PRECIO €
 KG / M³

PM-63/73/93-DX PORTA 300 DESTRA
 08430302 **EN** Right door 300 • **DE** Rechte tür 300 • **FR** Porte droite 300 • **ES**
PUERTA DERECHA 300
 cm. 29,5x 2,5x 47,5h



213,00
 3 / 0,01

PM-64/74/94-DX PORTA 400 DESTRA
 08430402 **EN** Right door 400 • **DE** Rechte tür 400 • **FR** Porte droite 400 • **ES**
PUERTA DERECHA 400
 cm. 39,5x 2,5x 47,5h



220,00
 3.5 / 0,02

PM-63/73/93-SX PORTA 300 SINISTRA
 08430303 **EN** Left door 300 • **DE** Linke tür 300 • **FR** Porte gauche 300 • **ES**
PUERTA IZQUIERDA 300
 cm. 29,5x 2,5x 47,5h

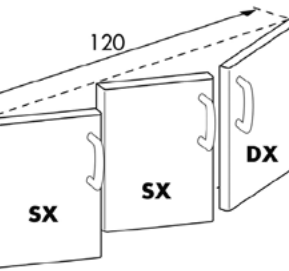

213,00
 3 / 0,01

PM-64/74/94-SX PORTA 400 SINISTRA
 08430403 **EN** Left door 400 • **DE** Linke tür 400 • **FR** Porte gauche 400 • **ES**
PUERTA IZQUIERDA 400
 cm. 39,5x 2,5x 47,5h

220,00
 3.5 / 0,02

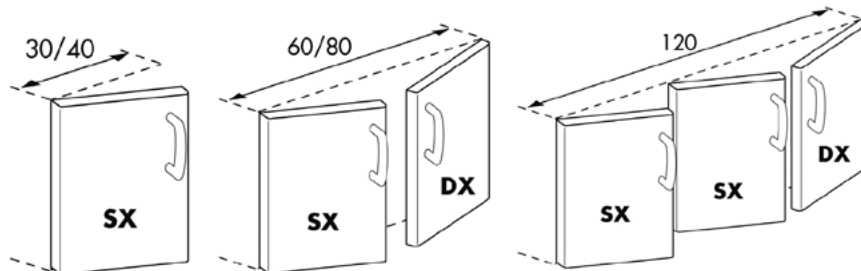

C-73/93 CASSETTIERA 300 N. 2 cassetti con 2 bacinelle inox, guide telescopiche.
 08440320 **EN** Drawer set 300 N. 2 drawers with 2 inox containers, telescopic guides. • **DE** Schubladen 300 - N. 2 Schubladen mit 2 Chromnickelstahlbehältern, Telescopeinführungen. • **FR** Tiroirs pour meuble de 300 N. 2 tiroirs avec 2 bacs inox, guides télescopiques. • **ES CAJONERA 300 - N. 2 CAJONES CON 2 CONTENEDORES DE ACERO INOX, GUÍAS TELESCÓPICAS.**
 cm. 29,5x 59x 47,5h



827,00
 16 / 0,19

C-74/94 CASSETTIERA 400 - N. 2 cassetti con 2 bacinelle GN 1/1 15h in plastica, guide telescopiche.
 08440420 **EN** Drawer set 400 - N. 2 drawers with 2 GN 1/1 15h plastic containers, telescopic guides. • **DE** Schubladen - N. 2 Schubladen mit 2 GN 1/1 15h Kunststoffbehältern, Telescopeinführungen. • **FR** Tiroirs pour meuble de 400 - N. 2 tiroirs avec 2 bacs en plastique GN 1/1 15h, guides télescopiques. • **ES CAJONERA 400 - N. 2 CAJONES CON 2 CONTENEDORES GN 1/1 15H DE PLÁSTICO, GUÍAS TELESCÓPICAS.**
 cm. 39,5x 59x 47,5h



849,00
 18 / 0,19

C-76/96 CASSETTIERA 600 N. 2 cassetti con 2 bacinelle inox, guide telescopiche.
 08440620 **EN** Drawer set 600 N. 2 drawers with 2 inox containers, telescopic guides. • **DE** Schubladen 600 - N. 2 Schubladen mit 2 Chromnickelstahlbehältern, Telescopeinführungen. • **FR** Tiroirs pour meuble de 600 N. 2 tiroirs avec 2 bacs inox, guides télescopiques. • **ES CAJONERA 600 - N. 2 CAJONES CON 2 CONTENEDORES DE ACERO INOX, GUÍAS TELESCÓPICAS.**
 cm. 59,5x 59x 47,5h



1.173,00
 22 / 0,28

ACCESSORI TOP

MOD. COD.	DESCRIZIONE/DESCRIPTION/BEZEICHNUNG/DESCRIPTION/DESCRIPCIÓN DIMENSIONI/DIMENSIONS/ABMESSUNGEN/DIMENSIONS/DIMENSIONES	POTENZA/POWER/LEISTUNG/PUISSANCE/POTENCIA VOLTAGGIO/VOLTAGE/SPANNUNG/VOLTAGE/VOLTAJE	$\frac{kW}{kcal/h}$ $\frac{V\sim}{Hz}$	PREZZO/PRICE € KG / M ³
C-78/98 08440820	CASSETTIERA 800 - N. 2 cassetti con 4 bacinelle GN 1/1 15h in plastica, guide telescopiche. EN Drawer set 800 - N. 2 drawers with 4 GN 1/1 15h plastic containers, telescopic guides. • DE Schubladen 800 - N. 2 Schubladen mit 4 GN 1/1 15h Kunststoffbehältern, Telescopeinführungen. • FR Tiroirs pour meuble de 800 - N. 2 tiroirs avec 4 bacs en plastique GN 1/1 15h, guides télescopiques. • ES CAJONERA 800 - N. 2 CAJONES CON 4 CONTENEDORES GN 1/1 15H DE PLÁSTICO, GUÍAS TELESCÓPICAS. cm. 79,5x 59x 47,5h			1.193,00 26 / 0,37
D-90 09470001	DIVISORIO base neutra EN Spacer for stand • DE Trennwand für offener unterbau • FR Separation pour placard ouvert • ES DIVISORIO PARA MUEBLE BASE cm. 5x 78x 38h			216,00 2.5 / 0,03
PT-74/94 08460002	PORTATEGLIE VANO 400 (GN-1/1) VANO 600 (GN-2/1) 4 ripiani int. 7 cm. EN Frame for plates 400 (GN-1/1) 600 (GN-2/1) - N. 4 shelves, wheel base 7 cm. • DE Auflangeschienen für bleche 400 (GN-1/1) 600 (GN-2/1) - N. 4 Etagen, Abstand 7 cm. • FR Kit porte-plaques 400 (GN-1/1) 600 (GN-2/1) - N. 4 étagères; 7 cm. • ES PORTACAZUELAS 400 (GN-1/1) 600 (GN-2/1) - N. 4 ESTANTES, INT. 7 CM.			459,00 2.5 / 0,01
PT-78/98 08460012	PORTATEGLIE VANO 800 (GN-2/1) 4 ripiani int. 7 cm. EN Frame for plates 800 (GN-2/1) 4 Etagen, Abstand 7 cm. • DE Auflangeschienen für bleche 800 (GN-2/1) N. 4 Etagen, Abstand 7 cm. • FR Kit porte-plaques 800 (GN-2/1) - N. 4 étagères; 7 cm. • ES PORTACAZUELAS 800 (GN-2/1) - N. 4 ESTANTES, INT. 7 CM.			613,00 4 / 0,01
531048800	CESTO 1/2 per F13T-G/E EN Basket 1/2 for F13T-G/E • DE Korb 1/2 zur Friteuse F13T-G/E • FR Panier 1/2 pour F13T-G/E • ES CESTA 1/2 PARA F13T-G/E cm. 13,5x 29x 9h			98,00 0.8 / 0,03

110

لوتس®

CUCINE A GAS

MOD. _____
COD. _____

DESCRIZIONE/DESCRIPTION/BEZEICHNUNG/DESCRIPTION/DESCRIPCIÓN
DIMENSIONI/DIMENSIONS/ABMESSUNGEN/DIMENSIONS/DIMENSIONES

POTENZA/POWER/LEISTUNG/PUISSANCE/POTENCIA
VOLTAGGIO/VOLTAGE/SPANNUNG/VOLTAGE/VOLTAJE

⚡ kW kcal/h
⚡ kW V- Hz

PREZZO/PRICE €
PREIS/PRIX/PRECIO €
KG / M³

CF4-118G
036I0850

CUCINA GAS PASSANTE 4 fuochi - FORNO GAS PASSANTE statico cm. 55x98x34h, temp: 150÷300°C, con 1 griglia cm. 53x32,5 GN-1/1 e 1 griglia cm.53x65 GN-2/1 (inclusa 1 testata chiusura piano mod.TPC-11)
EN Pass-through gas Range - N. 4 burners on Pass-through traditional gas-oven cm. 55x98x34h, temp: 150÷300°C, with 1 grid cm.53x32,5 GN-1/1 and 1 cm.53x65 GN-2/1 (included 1 Head end filler strip mod.TPC-11) • **DE** Durchgehende Gasherd - N. 4 Kochstellen mit Durchgehende Statischer Gas-Backofen cm. 55x98x34h, temp: 150÷300°C, mit 1 Rost cm.53x32,5 GN-1/1 und 1 cm.53x65 GN-2/1 (inbegriffen 1 Abschluss-Element mod.TPC-11) • **FR** Cuisiniere gaz traversant - N. 4 feux vifs Four à gaz traversant statique cm. 55x98x34h, temp: 150÷300°C, avec 1 grille cm.53x32,5 GN-1/1 et 1 cm.53x65 GN-2/1 (inclus 1 Élément de jonction top mod.TPC-11) • **ES COCINA A GAS PASANTE - N. 4 QUEMADORES HORNO A GAS PASANTE ESTÁTICO CM. 55X98X34H, TEMP: 150÷300°C, CON 1 PARILLA CM.53X32,5 GN-1/1 Y 1 CM.53X65 GN-2/1 (INCLUIDA 1 CHAPA DE CIERRE PARA TOP MOD.TPC-11) cm. 80x 110x 90h**



⚡ 44 kW 8.095,00
37.840 kcal/h 181 / 1,15

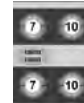

CF4-118GE
036J0860

CUCINA GAS PASSANTE 4 fuochi - FORNO ELETTRICO PASSANTE statico cm. 55x98x34h, temp: 50÷300°C, con 1 griglia cm. 53x32,5 GN-1/1 e 1 griglia cm.53x65 GN-2/1 (inclusa 1 testata chiusura piano mod.TPC-11)
EN Pass-through gas Range - N. 4 burners on Pass-through traditional electric oven cm. 55x98x34h, temp: 50÷300°C, with 1 grid cm.53x32,5 GN-1/1 and 1 cm.53x65 GN-2/1 (included 1 Head end filler strip mod.TPC-11) • **DE** Durchgehende Gasherd - N. 4 Kochstellen mit Durchgehende Statischer Elektro-Backofen cm. 55x98x34h, temp: 50÷300°C, mit 1 Rost cm.53x32,5 GN-1/1 und 1 cm.53x65 GN-2/1 (inbegriffen 1 Abschluss-Element mod.TPC-11) • **FR** Cuisiniere gaztraversant - N. 4 feux vifs Four électrique traversant statique cm. 55x98x34h, temp: 50÷300°C, avec 1 grille cm.53x32,5 GN-1/1 et 1 cm.53x65 GN-2/1 (inclus 1 Élément de jonction top mod.TPC-11) • **ES COCINA A GAS PASANTE - N. 4 QUEMADORES HORNO ELÉCTRICO PASANTE ESTÁTICO CM. 55X98X34H, TEMP: 50÷300°C, CON 1 PARILLA CM.53X32,5 GN-1/1 Y 1 CM.53X65 GN-2/1 (INCLUIDA 1 CHAPA DE CIERRE PARA TOP MOD.TPC-11) cm. 80x 110x 90h**



⚡ 34 kW 8.266,00
29.240 kcal/h 181 / 1,15

⚡ 7,5 kW
400V~3N
50/60 Hz



CFQ4-118ET
036G0831

CUCINA ELETTRICA PASSANTE 4 piastre quadre - FORNO ELETTRICO PASSANTE statico cm. 55x98x34h, temp: 50÷300°C, con 1 griglia cm. 53x32,5 GN-1/1 e 1 griglia cm.53x65 GN-2/1 (inclusa 1 testata chiusura piano mod.TPA-11)
EN Pass-through Electric range - N. 4 square plates on Pass-through Traditional electric oven cm. 55x98x34h, temp: 50÷300°C, with 1 grid cm.53x32,5 GN-1/1 and 1 cm.53x65 GN-2/1 (included 1 Head end filler strip mod.TPA-11) • **DE** Durchgehende Elektroherd - N. 4 quadratischen Platten mit Durchgehende Statischer Elektro-Backofen cm. 55x98x34h, temp: 50÷300°C, mit 1 Rost cm.53x32,5 GN-1/1 und 1 cm.53x65 GN-2/1 (inbegriffen 1 Abschluss-Element mod.TPA-11) • **FR** Fourneau électrique traversant - N. 4 plaques carrés - Four électrique traversant statique cm. 55x98x34h, temp: 50÷300°C, avec 1 grille cm.53x32,5 GN-1/1 et 1 cm.53x65 GN-2/1 (inclus 1 Élément de jonction top mod.TPA-11) • **ES COCINA ELÉCTRICA PASANTE - N. 4 PLANCHAS CUADRADAS HORNO ELÉCTRICO PASANTE ESTÁTICO CM. 55X98X34H, TEMP: 50÷300°C, CON 1 PARILLA CM.53X32,5 GN-1/1 Y 1 CM.53X65 GN-2/1 (INCLUIDA 1 CHAPA DE CIERRE PARA TOP MOD.TPA-11) cm. 80x 110x 90h**



⚡ 23,5 kW 10.735,00
400V~3N 167 / 1,15
50/60 Hz



PC-114G
032B0450

PIANO COTTURA GAS PASSANTE SU MOBILE A GIORNO 2 fuochi (inclusa 1 testata chiusura piano mod.TPC-11)
EN Pass-through Gas cooking top on open cabinet - 2 burners (included 1 Head end filler strip mod.TPC-11) • **DE** Durchgehende Gas-kochplatte mit offenem Unterbau - 2 Brenner (inbegriffen 1 Abschluss-Element mod.TPC-11) • **FR** Rechaud gaz traversant sur armoire ouvert - 2 feux vifs (inclus 1 Élément de jonction top mod.TPC-11) • **ES SOBRES DE COCCIÓN PASANTE GAS SOBRE MUEBLE ABIERTO - 2 QUEMADORES (INCLUIDA 1 CHAPA DE CIERRE PARA TOP MOD.TPC-11) cm. 40x 110x 90h**



⚡ 20 Kw 2.501,00
17.200 kcal/h 85 / 0,58



PIANI COTTURA A GAS

MOD. _____ DESCRIZIONE/DESCRIPTION/BEZEICHNUNG/DESCRIPTION/DESCRIPCIÓN POTENZA/POWER/LEISTUNG/PUISSANCE/POTENCIA ⚡ kW ⚡ kw PREZZO/PRICE €
 COD. _____ DIMENSIONI/DIMENSIONS/ABMESSUNGEN/DIMENSIONS/DIMENSIONES VOLTAGGIO/VOLTAGE/SPANNUNG/VOLTAGE/VOLTAJE kcal/h V~ / Hz PREIS/PRIX/PRECIO KG / M³

PC-118G
032B0850

PIANO COTTURA GAS PASSANTE SU MOBILE A GIORNO 4 fuochi (inclusa 1 testata chiusura piano mod.TPC-11)
EN Pass-through Gas cooking top on open cabinet - 4 burners (included 1 Head end filler strip mod.TPC-11) • **DE** Durchgehende Gas-kochplatte mit offenem Unterbau - 4 Brenner (inbegriffen 1 Abschluss-Element mod. TPC-11) • **FR** Rechaud gaz traversant sur armoire ouvert - 4 feux vifs (inclus 1 Élément de jonction top mod.TPC-11) • **ES SOBRES DE COCCIÓN PASANTE GAS SOBRE MUEBLE ABIERTO - 4 QUEMADORES (INCLUIDA 1 CHAPA DE CIERRE PARA TOP MOD.TPC-11)**
cm. 80x 110x 90h



⚡ 34 kW
29.240 kcal/h

4.161,00
140 / 1,15



PC-554G
03210450

PIANO COTTURA GAS SU MOBILE A GIORNO 1 fuoco (inclusa 1 testata chiusura piano mod.TPC-55)
EN Gas cooking top on open cabinet - 1 burner (included 1 Head end filler strip mod.TPC-55) • **DE** Gas-kochplatte mit offenem Unterbau - 1 Brenner (inbegriffen 1 Abschluss-Element mod.TPC-55) • **FR** Rechaud gaz sur armoire ouvert - 1 feu vif (inclus 1 Élément de jonction top mod. TPC-55) • **ES SOBRES DE COCCIÓN GAS SOBRE MUEBLE ABIERTO - 1 QUEMADOR (INCLUIDA 1 CHAPA DE CIERRE PARA TOP MOD.TPC-55)**
cm. 40x 55x 90h



⚡ 10 kW
8.600 kcal/h

1.914,00
49 / 0,37



PC-558G
03210850

PIANO COTTURA GAS SU MOBILE A GIORNO 2 fuochi (inclusa 1 testata chiusura piano mod.TPC-55)
EN Gas cooking top on open cabinet - 2 burners (included 1 Head end filler strip mod.TPC-55) • **DE** Gas-kochplatte mit offenem Unterbau - 2 Brenner (inbegriffen 1 Abschluss-Element mod.TPC-55) • **FR** Rechaud gaz sur armoire ouvert - 2 feux vifs (inclus 1 Élément de jonction top mod. TPC-55) • **ES SOBRES DE COCCIÓN GAS SOBRE MUEBLE ABIERTO - 2 QUEMADORES (INCLUIDA 1 CHAPA DE CIERRE PARA TOP MOD.TPC-55)**
cm. 80x 55x 90h



⚡ 17 kW
14.620 kcal/h

2.943,00
78 / 0,62



PCQ-118ET
030D0831

PIANO COTTURA ELETTRICO PASSANTE SU MOBILE A GIORNO - N. 4 piastre quadre (inclusa 1 testata chiusura piano mod.TPA-11)
EN Pass-through Electric Boiling unit on open cabinet - N. 4 square plates (included 1 Head end filler strip mod.TPA-11) • **DE** Durchgehende Kochplatte Elektrische mit offenem Unterbau N. 4 quadratischen Platten (inbegriffen 1 Abschluss-Element mod.TPA-11) • **FR** Rechaud électriques traversant sur armoire ouvert - N. 4 plaques carrés (inclus 1 Élément de jonction top mod.TPA-11) • **ES SOBRE DE COCCIÓN ELECTRICO PASANTE SOBRE MUEBLE ABIERTO N. 4 PLANCHAS CUADRADAS (INCLUIDA 1 CHAPA DE CIERRE PARA TOP MOD.TPA-11)**
cm. 80x 110x 90h



⚡ 16 kW
400V~3N
50/60 Hz

5.284,00
115 / 1,15



PCQ-558ET
03030831

PIANO COTTURA ELETTRICO SU MOBILE A GIORNO - N. 2 piastre quadre (inclusa 1 testata chiusura piano mod.TPA-55)
EN Electric Boiling unit on open cabinet - N. 2 square plates (included 1 Head end filler strip mod.TPA-55) • **DE** Kochplatte Elektrische mit offenem Unterbau N. 2 quadratischen Platten (inbegriffen 1 Abschluss-Element mod.TPA-55) • **FR** Rechaud électriques sur armoire ouvert - N. 2 plaques carrés (inclus 1 Élément de jonction top mod.TPA-55) • **ES SOBRE DE COCCIÓN ELECTRICO SOBRE MUEBLE ABIERTO N. 2 PLANCHAS CUADRADAS (INCLUIDA 1 CHAPA DE CIERRE PARA TOP MOD.TPA-55)**
cm. 80x 55x 90h



⚡ 8 kW
400V~2N
230V~3
230V~
50/60 Hz

2.924,00
60 / 0,62



PCI-114ET
030D0433

PIANO COTTURA INDUZIONE PASSANTE 2 zone - 2 vetri cm.35x35 (inclusa 1 testata chiusura piano mod.TPA-11)
EN Pass-through induction cooking top 2 zones - 2 glass cm.35x35 (included 1 Head end filler strip mod.TPA-11) • **DE** Durchgehende Induktions-Kochplatte 2 zonen - 2 Glas cm.35x35 (inbegriffen 1 Abschluss-Element mod.TPA-11) • **FR** Plan de cuisson à induction traversant 2 zones - 2 verre cm.35x35 (inclus 1 Élément de jonction top mod.TPA-11) • **ES ENCIMERA DE COCCIÓN INDUCCIÓN PASANTE 2 ZONAS - 2 VIDRO CM.35X35 (INCLUIDA 1 CHAPA DE CIERRE PARA TOP MOD.TPA-11)**
cm. 40x 110x 90h



⚡ 10 kW
400V~3
50/60 Hz

10.125,00
65 / 0,58

PIANI COTTURA A INDUZIONE

MOD. _____
COD. _____

DESCRIZIONE/DESCRIPTION/BEZEICHNUNG/DESCRIPTION/DESCRIPCIÓN
DIMENSIONI/DIMENSIONS/ABMESSUNGEN/DIMENSIONS/DIMENSIONES

POTENZA/POWER/LEISTUNG/PUISSANCE/POTENCIA
VOLTAGGIO/VOLTAGE/SPANNUNG/VOLTAGE/VOLTAJE

⚡ kW _____
kcal/h _____
V~ _____
Hz _____

PREZZO/PRICE €
PREIS/PRIX/PRECIO €
KG / M³

PCI-118ET
030D0833

PIANO COTTURA INDUZIONE PASSANTE 4 zone - 2 vetri cm.77x35
(inclusa 1 testata chiusura piano mod.TPA-11)

EN Pass-through induction cooking top 4 zones - 2 glass cm.75x35
(included 1 Head end filler strip mod.TPA-11) • **DE** Durchgehende
Induktions-Kochplatte 4 zonen - 2 Glas cm.75x35 (inbegriffen 1
Abschluss-Element mod.TPA-11) • **FR** Plan de cuisson à induction
traversant 4 zones - 2 verre cm.75x35 (inclus 1 Élément de jonction
top mod.TPA-11) • **ES ENCIMERA DE COCCIÓN INDUCCIÓN
PASANTE 4 ZONAS - 2 VIDRO CM.75X35 (INCLUIDA 1
CHAPA DE CIERRE PARA TOP MOD.TPA-11)**
cm. 80x 110x 90h



⚡ 20 kW _____ **19.234,00**
400V~3 _____ 115 / 1,15
50/60 Hz

PCI-558ET
03030833

PIANO COTTURA INDUZIONE 2 zone - Vetro cm.77x35 (inclusa 1 testata
chiusura piano mod.TPA-55)

EN Induction cooking top 2 zones - glass cm.77x35 (included 1 Head
end filler strip mod.TPA-55) • **DE** Induktions-Kochplatte 2 zonen - Glas
cm.77x35 (inbegriffen 1 Abschluss-Element mod.TPA-55) • **FR** Plan de
cuisson à induction 2 zones - Verre cm.77x35 (inclus 1 Élément de jonction
top mod.TPA-55) • **ES ENCIMERA DE COCCIÓN INDUCCIÓN 2
ZONAS - VIDRO CM.77X35 (INCLUIDA 1 CHAPA DE CIERRE
PARA TOP MOD.TPA-55)**
cm. 80x 55x 90h



⚡ 10 kW _____ **9.863,00**
400V~3 _____ 59 / 0,62
50/60 Hz

TUTTAPIASTRA A GAS CON FORNO

MOD. _____ DESCRIZIONE/DESCRIPTION/BEZEICHNUNG/DESCRIPTION/DESCRIPCIÓN POTENZA/POWER/LEISTUNG/PUISSANCE/POTENCIA PREZZO/PRICE €
 COD. _____ DIMENSIONI/DIMENSIONS/ABMESSUNGEN/DIMENSIONS/DIMENSIONES VOLTAGGIO/VOLTAGE/SPANNUNG/VOLTAGE/VOLTAJE kcal/h kw V~ Hz PREIS/PRIX/PRECIO € KG / M³

TPF-1110G TUTTA PIASTRA GAS PASSANTE SU FORNO GAS PASSANTE statico cm.
 037A1050 55x98x34h, temp: 150÷300°C, con 1 griglia cm. 53x32,5 GN-1/1 e 1 griglia cm.53x65 GN-2/1 - Piastra cm 73x79 - 2 vani neutri con porte (inclusa 1 testata chiusura piano mod.TPA-11)
EN Pass-through gas Solid top on Pass-through Traditional gas-oven cm. 55x98x34h, temp: 150÷300°C, with 1 grid cm.53x32,5 GN-1/1 and 1 cm.53x65 GN-2/1 - Plate cm. 73x79 - 2 neutral cabinet with doors (included 1 Head end filler strip mod.TPA-11) • **DE** Durchgehende Gas-Kochplatten mit Durchgehende Statischer Gas-Backofen cm. 55x98x34h, temp: 150÷300°C, mit 1 Rost cm.53x32,5 GN-1/1 und 1 cm.53x65 GN-2/1 - Platte cm. 73x79 - 2 Neutrales Schrankelement mit Tür (inbegriffen 1 Abschluss-Element mod.TPA-11) • **FR** Toute plaque gaz traversant sur Four à gaz traversant statique cm. 55x98x34h, temp: 150÷300°C, avec 1 grille cm.53x32,5 GN-1/1 et 1 cm.53x65 GN-2/1 - Plaque cm. 73x79 - 2 Élément neutre avec porte (inclus 1 Élément de jonction top mod.TPA-11) • **ES PLACA DE COCCIÓN GAS PASANTE SOBRE HORNO A GAS PASANTE ESTÁTICO CM. 55X98X34H, TEMP: 150÷300°C, CON 1 PARILLA CM.53X32,5 GN-1/1 Y 1 CM.53X65 GN-2/1 - PLACA CM. 73X79 - 2 ARMARIO NEUTRO CON PUERTAS (INCLUIDA 1 CHAPA DE CIERRE PARA TOP MOD.TPA-11) cm. 100x 110x 90h**



22 kW **8.847,00**
 18.920 kcal/h 245 / 1,53

TP-1110G TUTTA PIASTRA GAS PASSANTE SU MOBILE A GIORNO Piastra cm
 032J1050 73x79 (inclusa 1 testata chiusura piano mod.TPA-11)
EN Pass-through gas Solid top on open unit - Plate 73x79 cm (included 1 Head end filler strip mod.TPA-11) • **DE** Durchgehende Gas-Kochplatte mit offenem Unterbau - Platte 73x79 cm (inbegriffen 1 Abschluss-Element mod.TPA-11) • **FR** Toute plaque gaz traversant sur meuble ouvert - Plaque cm 73x79 (inclus 1 Élément de jonction top mod.TPA-11) • **ES PLACA DE COCCIÓN GAS PASANTE SOBRE MUEBLE ABIERTO - PLACA CM 73X79 (INCLUIDA 1 CHAPA DE CIERRE PARA TOP MOD.TPA-11) cm. 100x 110x 90h**



12 kW **6.265,00**
 10.320 kcal/h 198 / 1,53

TP-118ET TUTTA PIASTRA ELETTRICO PASSANTE SU MOBILE A GIORNO Piastra cm
 031C0830 70x68 - 4 zone (inclusa 1 testata chiusura piano mod.TPA-11)
EN Pass-through Electric Solid top on open unit - Plate cm. 70x68 (included 1 Head end filler strip mod.TPA-11) • **DE** Durchgehende Kochplatten Elektrische mit offenem Unterbau - Platte cm. 70x68 (inbegriffen 1 Abschluss-Element mod.TPA-11) • **FR** Toute plaque électriques traversant sur meuble ouvert - Plaque cm. 70x68 (inclus 1 Élément de jonction top mod.TPA-11) • **ES PLACA DE COCCIÓN ELECTRICA PASANTE SOBRE MUEBLE ABIERTO - PLACA CM. 70X68 (INCLUIDA 1 CHAPA DE CIERRE PARA TOP MOD. TPA-11) cm. 80x 110x 90h**



13,6 kW **7.275,00**
 400V~3N 153 / 1,15
 50/60 Hz

CP-558G CUOCIPASTA GAS. Vasca 40 litri cm. 51x30,7x32,7h. Rubinetto carico
 03270850 acqua, sfiatore + scarico a pavimento. (CESTI ESCLUSI) (inclusa 1 testata chiusura piano mod.TPA-55)
EN Gas pasta cooker 40 lts. Tank cm. 51x30,7x32,7h. Water loading cock + overflow device and floor draining (BASKETS EXCLUDED) (included 1 Head end filler strip mod.TPA-55) • **DE** Gas-Nudelkocher lt. 40. Becken cm. 51x30,7x32,7h. Wasserlauf-Hahn, + Überlauf-Vorrichtung und Ablauf am Boden (KORB AUSGESCHLOSSEN) (inbegriffen 1 Abschluss-Element mod.TPA-55) • **FR** Cuiseur à pates gaz lt. 40. Cuve cm.51x30,7x32,7h. Robinet d'arrivée d'eau trop plein + système de vidange au sol (PANIERS EXCLUS) (inclus 1 Élément de jonction top mod.TPA-55) • **ES CUECE PASTA GAS 40 LT. CUBA CM. 51X30,7X32,7H. GRIFO CARGA AGUA + VERTEDERO + DESCARGA A PAVIMENTO (CESTAS EXCLUIDAS) (INCLUIDA 1 CHAPA DE CIERRE PARA TOP MOD.TPA-55) cm. 80x 55x 90h**



13,95 kW **4.606,00**
 11.997 kcal/h 84 / 0,62
 0,02 kW
 230V~
 50/60 Hz

COMBINAZIONI

- Combinations / • Zusammenstellungen
- Combinaisons / • Combinación múltiple



CUOCIPASTA A GAS

MOD. _____
COD. _____

DESCRIZIONE/DESCRIPTION/BEZEICHNUNG/DESCRIPTION/DESCRIPCIÓN
DIMENSIONI/DIMENSIONS/ABMESSUNGEN/DIMENSIONS/DIMENSIONES

POTENZA/POWER/LEISTUNG/PUISSANCE/POTENCIA
VOLTAGGIO/VOLTAGE/SPANNUNG/VOLTAGE/VOLTAJE

⚡ kW
kcal/h

PREZZO/PRICE
PREIS/PRIX/PRECIO €
KG / M³

CPA-558G
03270855

CUOCIPASTA GAS. Vasca 40 litri cm. 51x30,7x32,7h. Carico acqua automatico con sensore di livello - sfioratore + scarico a pavimento (CESTI ESCLUSI) (inclusa 1 testata chiusura piano mod.TPA-55)
EN Gas pasta cooker 40 lts. Tank cm. 51x30,7x32,7h. Automatic Water loading with level sensor - overflow device and floor draining (BASKETS EXCLUDED) (included 1 Head end filler strip mod.TPA-55) • **DE** Gas-Nudelkocher lt. 40. Becken cm. 51x30,7x32,7h. Automatische Wasser Beladung mit Niveauregulierung + Überlauf-Vorrichtung und Ablauf am Boden (KORB AUSGESCHLOSSEN) (inbegriffen 1 Abschluss-Element mod.TPA-55) • **FR** Cuiseur à pates gaz lt. 40. Cuve cm.51x30,7x32,7h. Chargement automatique de l'eau avec sensor de niveau, trop plein Système de vidange au sol (PANIERS EXCLUS) (inclus 1 Élément de jonction top mod.TPA-55) • **ES CUECE PASTA GAS 40 LT. CUBA CM. 51X30,7X32,7H. CARGA AUTOMÁTICA DE AGUA CON SENSOR DE NIVEL + VERTEDERO + DESCARGA A PAVIMENTO. (CESTAS EXCLUIDAS) (INCLUIDA 1 CHAPA DE CIERRE PARA TOP MOD.TPA-55)**
cm. 80x 55x 90h



⚡ 13,95 kW **4.959,00**
11.997 kcal/h 84 / 0,62

⚡ 0,035 KW
230V~
50/60 Hz

COMBINAZIONI

- Combinations / • Zusammenstellungen
- Combinaisons / • Combinación múltiple



CP-558ET
03100830

CUOCIPASTA ELETTRICO. Vasca 40 litri cm. 51x30,7x32,7h. Rubinetto carico acqua, sfioratore + scarico a pavimento. (CESTI ESCLUSI) (inclusa 1 testata chiusura piano mod.TPA-55)
EN Electric Pasta cooker 40 lts Tank cm. 51x30,7x32,7h. Water loading cock + overflow device and floor draining (BASKETS EXCLUDED) (included 1 Head end filler strip mod.TPA-55) • **DE** Nudelkocher Elektrische lt. 40. Becken cm. 51x30,7x32,7h. Wasserlauf-Hahn, + Überlauf-Vorrichtung und Ablauf am Boden (KORB AUSGESCHLOSSEN) (inbegriffen 1 Abschluss-Element mod.TPA-55) • **FR** Cuiseur à pates électriques lt. 40. Cuve cm.51x30,7x32,7h. Robinet d'arrivée d'eau trop plein + système de vidange au sol (PANIERS EXCLUS) (inclus 1 Élément de jonction top mod.TPA-55) • **ES CUECE PASTA ELÉCTRICO 40 LT. CUBA CM. 51X30,7X32,7H. GRIFO CARGA AGUA + VERTEDERO + DESCARGA A PAVIMENTO (CESTAS EXCLUIDAS) (INCLUIDA 1 CHAPA DE CIERRE PARA TOP MOD.TPA-55)**
cm. 80x 55x 90h



⚡ 13,5 kW **4.469,00**
400V~3N 72 / 0,62
50/60 Hz

COMBINAZIONI

- Combinations / • Zusammenstellungen
- Combinaisons / • Combinación múltiple



CUOCIPASTA ELETTRICI

MOD. _____ DESCRIZIONE/DESCRIPTION/BEZEICHNUNG/DESCRIPTION/DESCRIPCIÓN POTENZA/POWER/LEISTUNG/PUISSANCE/POTENCIA ⚡ kW ⚡ kw PREZZO/PRICE €
 COD. _____ DIMENSIONI/DIMENSIONS/ABMESSUNGEN/DIMENSIONS/DIMENSIONES VOLTAGGIO/VOLTAGE/SPANNUNG/VOLTAGE/VOLTAJE kcal/h V~ Hz PREIS/PRIX/PRECIO €
 KG / M³

CPA-558ET CUOCIPASTA ELETTRICO. Vasca 40 litri cm. 51x30,7x32,7h. Carico acqua automatico con sensore di livello - sfioratore + scarico a pavimento (CESTI ESCLUSI) (inclusa 1 testata chiusura piano mod.TPA-55)
EN Electric Pasta cooker 40 lts Tank cm. 51x30,7x32,7h. Automatic Water loading with level sensor - overflow device and floor draining (BASKETS EXCLUDED) (included 1 Head end filler strip mod.TPA-55)
 • **DE** Nudelkocher Elektrische lt. 40. Becken cm. 51x30,7x32,7h. Automatische Wasser Beladung mit Niveauregulierung + Überlauf-Vorrichtung und Ablauf am Boden (KORB AUSGESCHLOSSEN) (inbegriffen 1 Abschluss-Element mod.TPA-55) • **FR** Cuiseur à pâtes électriques lt. 40. Cuve cm.51x30,7x32,7h. Chargement automatique de l'eau avec sensor de niveau, trop plein Système de vidange au sol (PANIERS EXCLUS) (inclus 1 Élément de jonction top mod.TPA-55) • **ES CUECE PASTA ELÉCTRICO 40 LT. CUBA CM. 51X30,7X32,7H. CARGA AUTOMÁTICA DE AGUA CON SENSOR DE NIVEL + VERTEDERO + DESCARGA A PAVIMENTO. (CESTAS EXCLUIDAS) (INCLUIDA 1 CHAPA DE CIERRE PARA TOP MOD.TPA-55)**
cm. 80x 55x 90h



⚡ 13,5 kW **4.959,00**
 400V~3N 72 / 0,62
 50/60 Hz

COMBINAZIONI

- Combinations / • Zusammenstellungen
- Combinaisons / • Combinación múltiple



BM-114EM BAGNOMARIA ELETTRICO PASSANTE SU MOBILE A GIORNO Vasca per GN-1/1 + GN-1/3 cm.15h. Rubinetto carico acqua, scarico a pavimento (inclusa 1 testata chiusura piano mod.TPA-11)
EN Pass-through Electric Bain-marie on open cabinet - Bowl for GN-1/1 + GN-1/3 cm.15h. Water loading top floor draining (included 1 Head end filler strip mod.TPA-11) • **DE** Durchgehende Wasserbäder elektrische mit Offenem Unterbau - Becken für GN-1/1 + GN-1/3 cm.15h. Wasserlauf-Hahn, Ablauf am Boden (inbegriffen 1 Abschluss-Element mod.TPA-11) • **FR** Bain marie électriques traversant sur armoire ouvert. Cuve pour GN-1/1 + GN-1/3 cm.15h. Robinet d'arrivée d'eau - Système de vidange au sol (inclus 1 Élément de jonction top mod.TPA-11) • **ES BAÑO DE MARÍA ELÉCTRICO PASANTE SOBRE MUEBLE ABIERTO, CUBA PARA GN-1/1 + GN-1/3 CM.15H. GRIFO CARGA AGUA, DESCARGA A PAVIMENTO (INCLUIDA 1 CHAPA DE CIERRE PARA TOP MOD.TPA-11)**
cm. 40x 110x 90h



⚡ 2,85 kW **2.918,00**
 230V~ 63 / 0,58
 50/60 Hz

FTL-1110GS Fry-top gas passante liscio cromato SUPERCHROME (Moca Approved), su mobile a giorno, piastra cm.76x85 - 2 zone di cottura (inclusa 1 testata chiusura piano mod.TPA-11)
EN Pass-through gas Fry-top smooth chromed griddle SUPERCHROME (Moca Approved), on open cabinet, plate cm.76x85 - 2 cooking areas (included 1 Head end filler strip mod.TPA-11) • **DE** Durchgehende Gas-griddleplatte glatt hartverchromt SUPERCHROME (Moca Approved), mit offenem Unterbau, platte cm.76x85 - 2 Heizzonen (inbegriffen 1 Abschluss-Element mod.TPA-11) • **FR** Plaque gaz traversant lisse chromée SUPERCHROME (Moca Approved), sur armoire ouvert, plaque cm.76x85 - 2 zones de cuisson (inclus 1 Élément de jonction top mod.TPA-11) • **ES FRY-TOP GAS PASANTE LISO CROMADO SUPERCHROME (MOCA APPROVED), SOBRE MUEBLE ABIERTO, PLANCHA CM.76X85 - 2 ZONAS DE COCCIÓN (INCLUIDA 1 CHAPA DE CIERRE PARA TOP MOD.TPA-11)**
cm. 100x 110x 90h



⚡ 24 kW **6.329,00**
 20.640 kcal/h 190 / 1,53

FRY-TOP A GAS

MOD. _____
COD. _____

DESCRIZIONE/DESCRIPTION/BEZEICHNUNG/DESCRIPTION/DESCRIPCIÓN
DIMENSIONI/DIMENSIONS/ABMESSUNGEN/DIMENSIONS/DIMENSIONES

POTENZA/POWER/LEISTUNG/PUISSANCE/POTENCIA ⚡ kW ⚡ kw PREZZO/PRICE €
VOLTAGGIO/VOLTAGE/SPANNUNG/VOLTAGE/VOLTAJE kcal/h V~ Hz PREIS/PRIX/PRECIO KG / M³

FTLR-1110GS Fry-top gas passante 1/2 rigato + 1/2 liscio cromato SUPERCHROME (Moca Approved), su mobile a giorno, piastra cm.76x85 - 2 zone di cottura (inclusa 1 testata chiusura piano mod.TPA-11)
EN Pass-through gas Fry-top 1/2 grooved + 1/2 smooth chromed griddle SUPERCHROME (Moca Approved), on open cabinet, plate cm.76x85 - 2 cooking areas (included 1 Head end filler strip mod. TPA-11) • **DE** Durchgehende Gas-griddleplatte 1/2 gerillt + 1/2 glatt hartverchromt SUPERCHROME (Moca Approved), mit offenem Unterbau, platte cm.76x85 - 2 Heizzonen (inbegriffen 1 Abschluss-Element mod. TPA-11) • **FR** Plaque gaz traversant 1/2 nervurée + 1/2 lisse chromée SUPERCHROME (Moca Approved), sur armoire ouvert, plaque cm.76x85 - 2 zones de cuisson (inclus 1 Élément de jonction top mod.TPA-11)
• **ES FRY-TOP GAS PASANTE 1/2 ESTRIADO + 1/2 LISO CROMADO SUPERCHROME (MOCA APPROVED), SOBRE MUEBLE ABIERTO, PLANCHA CM.76X85 - 2 ZONAS DE COCCIÓN (INCLUIDA 1 CHAPA DE CIERRE PARA TOP MOD. TPA-11)**
cm. 100x 110x 90h



⚡ 24 kW 6.624,00
20.640 kcal/h 190 / 1,53



FTL-558GS Fry-top gas liscio cromato SUPERCHROME (Moca Approved), su mobile a giorno, piastra cm.76x34 - 2 zone di cottura (inclusa 1 testata chiusura piano mod.TPA-55)
EN Gas Fry-top smooth chromed griddle SUPERCHROME (Moca Approved), on open cabinet, plate cm.76x34 - 2 cooking areas (included 1 Head end filler strip mod.TPA-55) • **DE** Gas-griddleplatte glatt hartverchromt SUPERCHROME (Moca Approved), mit offenem Unterbau, platte cm.76x34 - 2 Heizzonen (inbegriffen 1 Abschluss-Element mod.TPA-55) • **FR** Plaque gaz lisse chromée SUPERCHROME (Moca Approved), sur armoire ouvert, plaque cm.76x34 - 2 zones de cuisson (inclus 1 Élément de jonction top mod.TPA-55) • **ES FRY-TOP GAS LISO CROMADO SUPERCHROME (MOCA APPROVED), SOBRE MUEBLE ABIERTO, PLANCHA CM.76X34 - 2 ZONAS DE COCCIÓN (INCLUIDA 1 CHAPA DE CIERRE PARA TOP MOD. TPA-55)**
cm. 80x 55x 90h



⚡ 10 kW 3.888,00
8.600 kcal/h 96 / 0,62



FTLR-558GS Fry-top gas 1/2 rigato + 1/2 liscio cromato SUPERCHROME (Moca Approved), su mobile a giorno, piastra cm.76x34 - 2 zone di cottura (inclusa 1 testata chiusura piano mod.TPA-55)
EN Gas Fry-top 1/2 grooved + 1/2 smooth chromed griddle SUPERCHROME (Moca Approved), on open cabinet, plate cm.76x34 - 2 cooking areas (included 1 Head end filler strip mod.TPA-55) • **DE** Gas-griddleplatte 1/2 gerillt + 1/2 glatt hartverchromt SUPERCHROME (Moca Approved), mit offenem Unterbau, platte cm.76x34 - 2 Heizzonen (inbegriffen 1 Abschluss-Element mod.TPA-55) • **FR** Plaque gaz 1/2 nervurée + 1/2 lisse chromée SUPERCHROME (Moca Approved), sur armoire ouvert, plaque cm.76x34 - 2 zones de cuisson (inclus 1 Élément de jonction top mod.TPA-55) • **ES FRY-TOP GAS 1/2 ESTRIADO + 1/2 LISO CROMADO SUPERCHROME (MOCA APPROVED), SOBRE MUEBLE ABIERTO, PLANCHA CM.76X34 - 2 ZONAS DE COCCIÓN (INCLUIDA 1 CHAPA DE CIERRE PARA TOP MOD.TPA-55)**
cm. 80x 55x 90h



⚡ 10 kW 4.103,00
8.600 kcal/h 96 / 0,62



FTL-118ETS Fry-top elettrico passante liscio cromato SUPERCHROME (Moca Approved), su mobile a giorno, piastra cm.76x85 - 2 zone di cottura (inclusa 1 testata chiusura piano mod.TPA-11)
EN Pass-through Electric Fry-top smooth chromed griddle SUPERCHROME (Moca Approved), on open cabinet, plate cm.76x85 - 2 cooking areas (included 1 Head end filler strip mod.TPA-11) • **DE** Durchgehende Griddleplatte elektrische glatt hartverchromt SUPERCHROME (Moca Approved), mit offenem Unterbau, platte cm.76x85 - 2 Heizzonen (inbegriffen 1 Abschluss-Element mod.TPA-11) • **FR** Plaque électriques traversant lisse chromée SUPERCHROME (Moca Approved), sur armoire ouvert, plaque cm.76x85 - 2 zones de cuisson (inclus 1 Élément de jonction top mod.TPA-11) • **ES FRY-TOP ELÉCTRICO PASANTE LISO CROMADO SUPERCHROME (MOCA APPROVED), SOBRE MUEBLE ABIERTO, PLANCHA CM.76X85 - 2 ZONAS DE COCCIÓN (INCLUIDA 1 CHAPA DE CIERRE PARA TOP MOD.TPA-11)**
cm. 80x 110x 90h



⚡ 17 kW 5.777,00
400V~3N 160 / 1,15



FRY-TOP ELETTRICI

MOD. / COD. DESCRIZIONE / DESCRIPTION / BEZEICHNUNG / DESCRIPTION / DESCRIPCIÓN DIMENSIONI / DIMENSIONS / ABMESSUNGEN / DIMENSIONS / DIMENSIONES POTENZA / POWER / LEISTUNG / PUISSANCE / POTENCIA VOLTAGGIO / VOLTAGE / SPANNUNG / VOLTAGE / VOLTAJE $\frac{kW}{kcal/h}$ $\frac{kW}{V \sim}$ / Hz PREZZO / PRICE € / KG / M³

FTLR-118ETS Fry-top elettrico passante 1/2 rigato + 1/2 liscio cromato SUPERCHROME (Moca Approved), su mobile a giorno, piastra cm.76x85 - 2 zone di cottura (inclusa 1 testata chiusura piano mod.TPA-11)
EN Pass-through Electric Fry-top 1/2 grooved + 1/2 smooth chromed griddle SUPERCHROME (Moca Approved), on open cabinet, plate cm.76x85 - 2 cooking areas (included 1 Head end filler strip mod.TPA-11)
DE Durchgehende Griddleplatte elektrische 1/2 gerillt + 1/2 glatt hartverchromt SUPERCHROME (Moca Approved), mit offenem Unterbau, platte cm.76x85 - 2 Heizzonen (inbegriffen 1 Abschluss-Element mod. TPA-11)
FR Plaque électriques traversant 1/2 nervurée + 1/2 lisse chromée SUPERCHROME (Moca Approved), sur armoire ouvert, plaque cm.76x85 - 2 zones de cuisson (inclus 1 Élément de jonction top mod. TPA-11)
ES FRY-TOP ELÉCTRICO PASANTE 1/2 ESTRIADO + 1/2 LISO CROMADO SUPERCHROME (MOCA APPROVED), SOBRE MUEBLE ABIERTO, PLANCHA CM.76X85 - 2 ZONAS DE COCCIÓN (INCLUIDA 1 CHAPA DE CIERRE PARA TOP MOD.TPA-11)
cm. 80x 110x 90h



17 kW
400V~3N

6.060,00
160 / 1,15



FTL-558ETS Fry-top elettrico liscio cromato SUPERCHROME (Moca Approved), su mobile a giorno, piastra cm.76x34 - 2 zone di cottura (inclusa 1 testata chiusura piano mod.TPA-55)
EN Electric Fry-top smooth chromed griddle SUPERCHROME (Moca Approved), on open cabinet, plate cm.76x34 - 2 cooking areas (included 1 Head end filler strip mod.TPA-55)
DE Griddleplatte elektrische glatt hartverchromt SUPERCHROME (Moca Approved), mit offenem Unterbau, platte cm.76x34 - 2 Heizzonen (inbegriffen 1 Abschluss-Element mod.TPA-55)
FR Plaque électriques lisse chromée SUPERCHROME (Moca Approved), sur armoire ouvert, plaque cm.76x34 - 2 zones de cuisson (inclus 1 Élément de jonction top mod.TPA-55)
ES FRY-TOP ELÉCTRICO LISO CROMADO SUPERCHROME (MOCA APPROVED), SOBRE MUEBLE ABIERTO, PLANCHA CM.76X34 - 2 ZONAS DE COCCIÓN (INCLUIDA 1 CHAPA DE CIERRE PARA TOP MOD.TPA-55)
cm. 80x 55x 90h



6,6 kW
400V~2N
230V~3
230V~

3.877,00
84 / 0,62



FTLR-558ETS Fry-top elettrico 1/2 rigato + 1/2 liscio cromato SUPERCHROME (Moca Approved), su mobile a giorno, piastra cm.76x34 - 2 zone di cottura (inclusa 1 testata chiusura piano mod.TPA-55)
EN Electric Fry-top 1/2 grooved + 1/2 smooth chromed griddle SUPERCHROME (Moca Approved), on open cabinet, plate cm.76x34 - 2 cooking areas (included 1 Head end filler strip mod.TPA-55)
DE Griddleplatte elektrische 1/2 gerillt + 1/2 glatt hartverchromt SUPERCHROME (Moca Approved), mit offenem Unterbau, platte cm.76x34 - 2 Heizzonen (inbegriffen 1 Abschluss-Element mod. TPA-55)
FR Plaque électriques 1/2 nervurée + 1/2 lisse chromée SUPERCHROME (Moca Approved), sur armoire ouvert, plaque cm.76x34 - 2 zones de cuisson (inclus 1 Élément de jonction top mod.TPA-55)
ES FRY-TOP ELÉCTRICO 1/2 ESTRIADO + 1/2 LISO CROMADO SUPERCHROME (MOCA APPROVED), SOBRE MUEBLE ABIERTO, PLANCHA CM.76X34 - 2 ZONAS DE COCCIÓN (INCLUIDA 1 CHAPA DE CIERRE PARA TOP MOD.TPA-55)
cm. 80x 55x 90h



6,6 kW
400V~2N
230V~3
230V~

4.121,00
84 / 0,62



CW-114G GRIGLIA GAS-PIETRALAVICA PASSANTE SU MOBILE A GIORNO Griglia in acciaio inox cm. 38x52 regolabile (inclusa 1 testata chiusura piano mod.TPA-11)
EN Pass-through Charcoal grill gas on open cabinet Stainless steel grill cm. 38x52 (included 1 Head end filler strip mod.TPA-11)
DE Durchgehende Gas-Lavasteingrill mit offenem Unterbau Einstellbarer Rost aus Nirosta cm. 38x52 (inbegriffen 1 Abschluss-Element mod.TPA-11)
FR Grille à gaz en pierre de lave traversant sur armoire ouvert Grille inox cm 38x52 (inclus 1 Élément de jonction top mod.TPA-11)
ES PARRILLA A GAS PIEDRA LÁVICA PASANTE SOBRE MUEBLE ABIERTO PARRILLA DE ACERO INOX REGULABLE CM 38X52 (INCLUIDA 1 CHAPA DE CIERRE PARA TOP MOD.TPA-11)
cm. 40x 110x 90h



9 kW
7.740 kcal/h

3.170,00
83 / 0,58

GRIGLIE ELETTRICHE

MOD. _____
COD. _____

DESCRIZIONE/DESCRIPTION/BEZEICHNUNG/DESCRIPTION/DESCRIPCIÓN
DIMENSIONI/DIMENSIONS/ABMESSUNGEN/DIMENSIONS/DIMENSIONES

POTENZA/POWER/LEISTUNG/PUISSANCE/POTENCIA
VOLTAGGIO/VOLTAGE/SPANNUNG/VOLTAGE/VOLTAJE

⚡ kW
kcal/h
V~
Hz

PREZZO/PRICE
PREIS/PRIX/PRECIO €
KG / M³

CWK-114ET GRIGLIA CONTACT PASSANTE SU MOBILE A GIORNO - cottura diretta su resistenza in acciaio inox cm. 27x43 ribaltabile (inclusa 1 testata chiusura piano mod.TPA-11)
03010431
EN Pass-through Electric contact Grill on open cabinet - rotatable stainless steel grill cm. 27x43 (included 1 Head end filler strip mod.TPA-11) • **DE** Durchgehende Elektrische Wurstbrater KONTAKT mit offenem Unterbau - Drehbaren Heizelement aus Edelstahl cm. 27x43 (inbegriffen 1 Abschluss-Element mod.TPA-11) • **FR** Grillade électrique CONTACT traversant sur armoire ouvert- Grille inox rotatif cm 27x43 (inclus 1 Élément de jonction top mod.TPA-11) • **ES PARRILLA ELECTRICA CONTACT PASANTE SOBRE MUEBLE ABIERTO - PARRILLA GIRATORIA DE ACERO INOX CM 27X43 (INCLUIDA 1 CHAPA DE CIERRE PARA TOP MOD.TPA-11)**
cm. 40x 110x 90h



⚡ 4,08 kW
400V~3N
50/60 Hz
3.917,00
83 / 0,58

F13-554G FRIGGITRICE gas 13 litri, vasca cm. 32,5x31,5x36h - 1 cesto cm. 30x27,5x12h - Filtro e coperchio vasca. Bacinella raccogliolio con filtro. - Produzione patate: 10 kg/h
03260450
EN Gas fryer 13 lts - Bowl cm. 32,5x31,5x36h - 1 basket cm. 30x27,5x12h. Sieve and lid for pan. - Drip tray with sieve. Production: 10 kg/h • **DE** Gas-Friteuse lt. 13 - Becken cm. 32,5x31,5x36h - 1 Korb cm. 30x27,5x12h. Einlegesieb und Deckel für Becken. - Fettauffangschale mit Sieb. Pommes frites: 10 kg/h • **FR** Friteuse a gaz lt. 13 - Cuve cm. 32,5x31,5x36h - 1 Panier cm. 30x27,5x12h. Filtre, couvercle pour cuve. - Bac de récupération de l'huile avec filtre. Production de pommes frites: 10 kg/h • **ES FREIDORA A GAS 13 LT. - CUBA CM. 32,5X31,5X36H - 1 CESTA CM. 30X27,5X12H. FILTRO Y TAPA PARA CUBA. BANDEJA RECOGE ACEITE CON FILTRO. PROD. PATATAS: 10 KG/H**
cm. 40x 55x 90h



⚡ 10,5 kW
9.030 kcal/h
3.033,00
60 / 0,37

F13-554ET FRIGGITRICE elettrica 13 litri, vasca cm. 24x35x32h - 1 cesto cm. 21x30x12h - Filtro e coperchio vasca. Bacinella raccogliolio con filtro. - Produzione patate: 10 kg/h
03090430
EN Electric Fryer 13 lts - Bowl cm. 24x35x32h - 1 basket cm. 21x30x12h. Sieve and lid for pan. - Drip tray with sieve. Production: 10 kg/h • **DE** Elektrische Friteuse lt. 13 - Becken cm. 24x35x32h - 1 Korb cm. 21x30x12h. Einlegesieb und Deckel für Becken. - Fettauffangschale mit Sieb. Pommes frites: 10 kg/h • **FR** Friteuse électrique lt. 13 - Cuve cm. 24x35x32h - 1 Panier cm. 21x30x12h. Filtre, couvercle pour cuve. - Bac de récupération de l'huile avec filtre. Production de pommes frites: 10 kg/h • **ES FREIDORA ELECTRICA 13 LT. - CUBA CM. 24X35X32H - 1 CESTA CM. 21X30X12H. FILTRO Y TAPA PARA CUBA. BANDEJA RECOGE ACEITE CON FILTRO. PROD. PATATAS: 10 KG/H**
cm. 40x 55x 90h



⚡ 10,95 kW
400V~3N
50/60 Hz
2.805,00
52 / 0,37

BRF-558ET BRASIERA FISSA MULTIFUNZIONALE elettrica, vasca cm. 68x30x10h (inclusa 1 testata chiusura piano mod.TPA-55)
03070833
EN Electric Multi-function fixed braising pan bowl cm. 68x30x10h (included 1 Head end filler strip mod.TPA-55) • **DE** Multifunktionsbratpfanne fest becken cm. 68x30x10h (inbegriffen 1 Abschluss-Element mod.TPA-55) • **FR** Sauteuse fixe multifonction cuve cm. 68x30x10h (inclus 1 Élément de jonction top mod.TPA-55) • **ES SARTEN FIJA MULTIFUNCIÓN CUBA CM. 68X30X10H (INCLUIDA 1 CHAPA DE CIERRE PARA TOP MOD.TPA-55)**
cm. 80x 55x 90h



⚡ 5,2 kW
400V~2N
50/60 Hz
5.051,00
80 / 0,62

PL-112 PIANO LAVORO PASSANTE SU MOBILE (inclusa 1 testata chiusura piano mod.TPA-11)
030B0200
EN Pass-through worktop on cabinet (included 1 Head end filler strip mod.TPA-11) • **DE** Durchgehende Arbeitsplatte mit Unterbau (inbegriffen 1 Abschluss-Element mod.TPA-11) • **FR** Plan de travail traversant sur armoire (inclus 1 Élément de jonction top mod.TPA-11) • **ES SOBRE DE TRABAJO PASANTE SOBRE MUEBLE (INCLUIDA 1 CHAPA DE CIERRE PARA TOP MOD.TPA-11)**
cm. 20x 110x 90h



1.516,00
40 / 0,58

PIANI LAVORO

MOD. _____ DESCRIZIONE/DESCRIPTION/BEZEICHNUNG/DESCRIPTION/DESCRIPCIÓN POTENZA/POWER/LEISTUNG/PUISSANCE/POTENCIA kW kcal/h PREZZO/PRICE €
 COD. _____ DIMENSIONI/DIMENSIONS/ABMESSUNGEN/DIMENSIONS/DIMENSIONES VOLTAGGIO/VOLTAGE/SPANNUNG/VOLTAGE/VOLTAJE V~ Hz PREIS/PRIX/PRECIO €
 KG / M³

PL-114
030B0400

PIANO LAVORO PASSANTE SU MOBILE A GIORNO, 2 cassetti con 2 bacinelle GN-2/3 cm.15h inox (inclusa 1 testata chiusura piano mod. TPA-11)
EN Pass-through worktop on open cabinet, 2 drawers with 2 GN-2/3 cm.15h inox containers. (included 1 Head end filler strip mod.TPA-11)
 • **DE** Durchgehende Arbeitsplatte mit offenem Unterbau, 2 Schubladen mit 2 GN-2/3 cm.15h Behälter aus Edelstahl. (inbegriffen 1 Abschluss-Element mod.TPA-11) • **FR** Plan de travail traversant sur armoire ouvert, 2 tiroirs avec 2 bacs GN-2/3 cm.15h inox. (inclus 1 Élément de jonction top mod.TPA-11) • **ES SOBRE DE TRABAJO PASANTE SOBRE MUEBLE ABIERTO, 2 CAJONES CON 2 CONTENEDORES GN-2/3 CM.15H DE ACERO INOX. (INCLUIDA 1 CHAPA DE CIERRE PARA TOP MOD.TPA-11)**
cm. 40x 110x 90h



2.452,00
70 / 0,58

PL-554
03010400

PIANO LAVORO SU MOBILE A GIORNO, cassetto con 1 bacinella GN-2/3 cm.15h inox (inclusa 1 testata chiusura piano mod.TPA-55)
EN Worktop on open cabinet, Drawer with 1 container GN-2/3 cm.15h inox. (included 1 Head end filler strip mod.TPA-55) • **DE** Arbeitsplatte mit offenem Unterbau, schublade mit 1 GN-2/3 cm.15h Behälter aus Edelstahl. (inbegriffen 1 Abschluss-Element mod.TPA-55) • **FR** Plan de travail sur armoire ouvert, tiroir avec 1 bac GN-2/3 cm.15h inox. (inclus 1 Élément de jonction top mod.TPA-55) • **ES SOBRE DE TRABAJO SOBRE MUEBLE ABIERTO, CAJÓN CON 1 CONTENEDOR GN-2/3 CM.15H DE ACERO INOX (INCLUIDA 1 CHAPA DE CIERRE PARA TOP MOD.TPA-55)**
cm. 40x 55x 90h



1.254,00
40 / 0,37

PL-558
03010800

PIANO LAVORO SU MOBILE A GIORNO, cassetto con 1 bacinella GN-1/1 e 1 bacinella GN-1/3 cm.15h inox (inclusa 1 testata chiusura piano mod.TPA-55)
EN Worktop on open cabinet, Drawer with 1 container GN-1/1 and 1 GN-1/3 cm.15h inox. (included 1 Head end filler strip mod.TPA-55)
 • **DE** Arbeitsplatte mit offenem Unterbau, schublade mit 1 GN-1/1 und 1 GN-1/3 cm.15h Behälter aus Edelstahl. (inbegriffen 1 Abschluss-Element mod.TPA-55) • **FR** Plan de travail sur armoire ouvert, tiroir avec 1 bac GN-1/1 et 1 GN-1/3 cm.15h inox. (inclus 1 Élément de jonction top mod.TPA-55) • **ES SOBRE DE TRABAJO SOBRE MUEBLE ABIERTO, CAJÓN CON 1 CONTENEDOR GN-1/1 Y 1 GN-1/3 CM.15H DE ACERO INOX (INCLUIDA 1 CHAPA DE CIERRE PARA TOP MOD.TPA-55)**
cm. 80x 55x 90h



1.939,00
65 / 0,62

P-73/93-DX
08430300

PORTA 300 DESTRA
EN Right door 300 • **DE** Rechte tür 300 • **FR** Porte droite 300 • **ES PUERTA DERECHA 300**
cm. 29,5x 2,5x 47,5h



213,00
3 / 0,01

P-74/94-DX
08430400

PORTA 400 DESTRA
EN Right door 400 • **DE** Rechte tür 400 • **FR** Porte droite 400 • **ES PUERTA DERECHA 400**
cm. 39,5x 2,5x 47,5h

220,00
3.5 / 0,02

ACCESSORI

MOD. _____ DESCRIZIONE/DESCRIPTION/BEZEICHNUNG/DESCRIPTION/DESCRIPCIÓN POTENZA/POWER/LEISTUNG/PUISSANCE/POTENCIA ⚡kW ⚡kw PREZZO/PRICE €
 COD. _____ DIMENSIONI/DIMENSIONS/ABMESSUNGEN/DIMENSIONS/DIMENSIONES VOLTAGGIO/VOLTAGE/SPANNUNG/VOLTAGE/VOLTAJE kcal/h kcal/h V~ Hz PREIS/PRIX/PRECIO €
 KG / M³

P-73/93-SX PORTA 300 SINISTRA
 08430301 **EN** Left door 300 • **DE** Linke tür 300 • **FR** Porte gauche 300 • **ES** PUERTA IZQUIERDA 300
 cm. 29,5x 2,5x 47,5h



213,00
 3 / 0,01

P-74/94-SX PORTA 400 SINISTRA
 08430401 **EN** Left door 400 • **DE** Linke tür 400 • **FR** Porte gauche 400 • **ES** PUERTA IZQUIERDA 400
 cm. 39,5x 2,5x 47,5h

220,00
 3.5 / 0,02

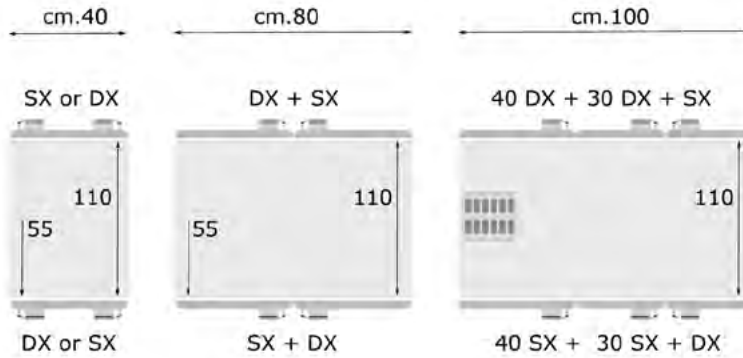

C-554 CASSETTIERA cm.40 - N. 2 cassetti con 2 bacinelle GN-2/3 cm.15h, guide telescopiche. (no per BM-114E)
 03440420 **EN** Drawer set cm.40 - N. 2 drawers with 2 GN-2/3 cm.15h inox containers, telescopic guides. (no for BM-114E) • **DE** Schubladen cm.40 - N. 2 Schubladen mit 2 GN-2/3 cm.15h Behälter aus Edelstahl, Telescopeinführungen. (nein für BM-114E) • **FR** Tiroirs pour meuble de cm.40 - N. 2 tiroirs avec 2 bacs GN-2/3 cm.15h inox, guides télescopiques. (no pour BM-114E) • **ES CAJONERA CM.40 - N. 2 CAJONES CON 2 CONTENEDORES GN-2/3 CM.15H DE ACERO INOX, GUÍAS TELESCÓPICAS. (NO PARA BM-114E)**
 cm. 39,5x 50x 47,5h



781,00
 11 / 0,19

C-558 CASSETTIERA cm.80 - N. 2 cassetti con 2 bacinelle GN-1/1 e 2 bacinelle GN-1/3 cm.15h, guide telescopiche. (no per PC-118G)
 03440820 **EN** Drawer set cm.80 - N. 2 drawers with 2 GN-1/1 and 2 GN-1/3 cm.15h inox containers, telescopic guides. (no for PC-118G) • **DE** Schubladen cm.80 - N. 2 Schubladen mit 2 GN-1/1 und 2 GN-1/3 cm.15h Behälter aus Edelstahl, Telescopeinführungen. (nein für PC-118G) • **FR** Tiroirs pour meuble de cm.80 - N. 2 tiroirs avec 2 bacs GN-1/1 et 2 GN-1/3 cm.15h inox, guides télescopiques. (no pour PC-118G) • **ES CAJONERA CM.80 - N. 2 CAJONES CON 2 CONTENEDORES GN-1/1 Y 2 GN-1/3 CM.15H DE ACERO INOX, GUÍAS TELESCÓPICAS. (NO PARA PC-118G)**
 cm. 79,5x 50x 47,5h



1.075,00
 19 / 0,37

D-11 DIVISORIO DOPPIO
 034H0000 **EN** Double Spacer • **DE** Doppelt Trennwand • **FR** Separation Double • **ES DIVISORIO DOBLE**
 cm. 5x 101x 42h



325,00
 4 / 0,03

ACCESSORI

MOD. COD.	DESCRIZIONE/DESCRIPTION/BEZEICHNUNG/DESCRIPTION/DESCRIPCIÓN DIMENSIONI/DIMENSIONS/ABMESSUNGEN/DIMENSIONS/DIMENSIONES	POTENZA/POWER/LEISTUNG/PUISSANCE/POTENCIA VOLTAGGIO/VOLTAGE/SPANNUNG/VOLTAGE/VOLTAJE	⚡ kcal/h	⚡ V~ Hz	PREZZO/PRICE € KG / M³
D-55 03470000	DIVISORIO EN Spacer • DE Trennwand • FR Separation • ES DIVISORIO cm. 5x 47x 42h				165,00 2 / 0,02
R-114 034F0400	RIPIANO (no per BM-114E) EN Shelf (no for BM-114E) • DE Zwischenboden (nein für BM-114E) • FR Étagère (no pour BM-114E) • ES ESTANTE (NO PARA BM-114E) cm. 35x100,5x 3,8h				233,00 5 / 0,03
R-118 034F0800	RIPIANO (no per PC-118G) EN Shelf (no for PC-118G) • DE Zwischenboden (nein für PC-118G) • FR Étagère (no pour PC-118G) • ES ESTANTE (NO PARA PC-118G) cm. 75x100,5x 3,8h				321,00 10 / 0,06
R-1110 034F1000	RIPIANO EN Shelf • DE Abstellbrett • FR Étagère • ES ESTANTE cm. 95x100,5x 3,8h				395,00 12 / 0,07
R-554 03450400	cm. 35x 47x 3,8h				136,00 2,5 / 0,01
R-558 03450800	cm. 75x 47x 3,8h				177,00 5 / 0,03
PT-114 034G0002	Portateglie 5 livelli interasse 7cm. per mobili profondità cm.110. Capacità GN1/1+GN2/3 su cm.40 o 3xGN1/1 su cm.60 EN Frame for plates 5 shelves, wheel-base cm.7. For appliance with cm.110 deep, capacity GN1/1+GN2/3 on cm.40 or 3xGN1/1 on cm.60 • DE Auflangeschienen für bleche 5 Etagen, Abstand 7 cm. für Möbeltiefe cm.110. Kapazität GN1/1+GN2/3 auf cm.40 oder 3xGN1/1 auf cm.60 • FR Kit porte-plaques 5 étagères et empattement cm.7. Pour meuble profondeur cm.110, capacité GN1/1+GN2/3 sur cm.40 ou 3xGN1/1 sur cm.60 • ES PORTACAZUELAS 5 ESTANTES CON ESPACIO DE CM.7. PARA EQUIPO DE CM.110 DE PROFUNDIDAD, CAPACIDAD GN1/1+GN2/3 EN CM.40 O 3XGN1/1 EN CM.60				770,00 5 / 0,02
PT-554 03460002	Portateglie 5 livelli interasse 7cm. per mobili profondità cm.55. Capacità GN-2/3 su cm.40 o GN-1/1 su cm.60. EN Frame for plates 5 shelves, wheel-base cm.7. For appliance with cm.55 deep, capacity GN2/3 on cm.40 or GN1/1 on cm.60 • DE Auflangeschienen für bleche 5 Etagen, Abstand 7 cm. für Möbeltiefe cm.55. Kapazität GN2/3 auf cm.40 oder GN1/1 auf cm.60 • FR Kit porte-plaques 5 étagères et empattement cm.7. Pour meuble profondeur cm.55, capacité GN2/3 sur cm.40 ou GN1/1 sur cm.60 • ES PORTACAZUELAS 5 ESTANTES CON ESPACIO DE CM.7. PARA EQUIPO DE CM.55 DE PROFUNDIDAD, CAPACIDAD GN2/3 EN CM.40 O GN1/1 EN CM.60				455,00 2.5 / 0,02

ACCESSORI CUOCIPASTA

MOD. _____
COD. _____

DESCRIZIONE/DESCRIPTION/BEZEICHNUNG/DESCRIPTION/DESCRIPCIÓN
DIMENSIONI/DIMENSIONS/ABMESSUNGEN/DIMENSIONS/DIMENSIONES

POTENZA/POWER/LEISTUNG/PUISSANCE/POTENCIA
VOLTAGGIO/VOLTAGE/SPANNUNG/VOLTAGE/VOLTAJE

⚡ kW kcal/h ⚡ kw V- Hz

PREZZO/PRICE €
PREIS/PRIX/PRECIO €
KG / M³

531053900 CESTO 1/1 PER CP
EN Basket 1/1 for CP • **DE** Korb 1/1 für CP • **FR** Panier 1/1 pour CP
• **ES CESTA 1/1 PARA CP**
cm. 49x 29x 20h

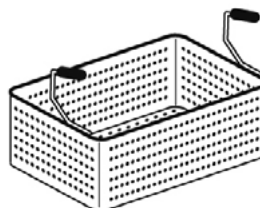

..539..

198,00
3,5 / 0,08

531017900 CESTO 1/3 PER CP
EN Basket 1/3 for CP • **DE** Korb 1/3 für CP • **FR** Panier 1/3 pour CP
• **ES CESTA 1/3 PARA CP**
cm. 16x 29x 20h

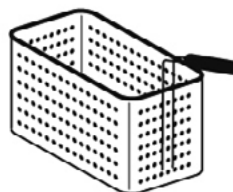

..179..

145,00
1,5 / 0,05

531064300 CESTO 1/4 PER CP
EN Basket 1/4 for CP • **DE** Korb 1/4 für CP • **FR** Panier 1/4 pour CP
• **ES CESTA 1/4 PARA CP**
cm. 11,5x 29x 20h

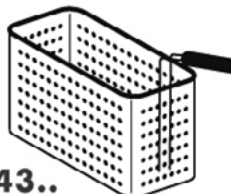

.643..

130,00
1,2 / 0,04

531084100 GRIGLIA IN TONDINO 1 FUOCO S110
EN grid rod 1 burner S110 line • **DE** Gitterstab 1 Brenner S110 • **FR** tige grille 1 feu S110 • **ES RED DE VARILLA 1 QUEMADOR S110**
cm. 38x 35x 5h



184,00
6 / 0,02

08570401 GRIGLIA TONDINO per CW-114G
EN Grid for CW-114G • **DE** Gitter für CW-114G • **FR** Grille ronde pour CW-114G • **ES REJILLA PARA CW-114G**
cm. 36x 51



455,00
11 / 0,03
18,28
28

08570402 GRIGLIA TEGOLO V per CW-114G
EN Grid V for CW-114G • **DE** Gitter V für CW-114G • **FR** Grille V pour CW-114G • **ES REJILLA V PARA CW-114G**
cm. 36x 51



455,00
11 / 0,03
5
23,5

544023800 RASCHIETTO PER PIASTRA RIGATA
EN Scraper for grooved plate • **DE** Schaber für gerillte Kochplatte
• **FR** Racloir pour plaque nervurée • **ES RASQUETA PARA PLACA RANURADA**



69,00
/ 1,00

ACCESSORI FRY-TOP

MOD. COD.	DESCRIZIONE/DESCRIPTION/BEZEICHNUNG/DESCRIPTION/DESCRIPCIÓN DIMENSIONI/DIMENSIONS/ABMESSUNGEN/DIMENSIONS/DIMENSIONES	POTENZA/POWER/LEISTUNG/PUISSANCE/POTENCIA VOLTAGGIO/VOLTAGE/SPANNUNG/VOLTAGE/VOLTAJE	$\frac{kW}{kcal/h}$ $\frac{kW}{V-}$ Hz	PREZZO/PRICE € PREIS/PRIX/PRECIO € KG / M ³
T-FT 09580060	TAPPO PER FRY-TOP EN stopper for Fry-top • DE Stopfen griddleplatte • FR bouchon pour Plaque • ES TAPÓN FRY-TOP cm. 10x 2x 5h			268,00 / 0,00
531013200	CESTO 1/2 PER F13-554E EN Basket 1/2 for F13-554E • DE Korb 1/2 für F13-554E • FR Panier 1/2 pour F13-554E • ES CESTA 1/2 PARA F13-554E cm. 10x 30x 12h			63,00 0.7 / 0,03
531053300	CESTO 1/2 PER F13-554G EN Basket 1/2 for F13-554G • DE Korb 1/2 für F13-554G • FR Panier 1/2 pour F13-554G • ES CESTA 1/2 PARA F13-554G cm. 15x 27x 12h			85,00 0.7 / 0,04
09550400	COPERCHIO per BRF-114 EN Lid for BRF-114 • DE Deckel für BRF-114 • FR Couvercle pour BRF-114 • ES TAPA PARA BRF-114 cm. 32x 70x 5h			154,00 2.5 / 0,01
PLF/9 09590401	PIASTRA LISCIA per GRIGLIA IN GHISA EN Smooth griddle plate for cast iron grid • DE Fortkochplatte glatt für Gusseisen Rost • FR Plaque lisse pour la grille en fonte • ES PLANCHA LISA PARA REJILLA DE HIERRO FUNDIDO cm. 36x 39			216,00 11 / 0,01
PRF/9 09590403	PIASTRA RIGATA per GRIGLIA IN GHISA EN Grooved griddle plate for cast iron grid • DE Fortkochplatte gerillt für Gusseisen Rost • FR Plaque nervurée pour la grille en fonte • ES PLANCHA ESTRIADA PARA REJILLA DE HIERRO FUNDIDO cm. 36x 39			291,00 11 / 0,01
PLFT/9 09590451	PIASTRA LISCIA per GRIGLIA IN TONDINO EN Smooth griddle plate for grid rod • DE Fortkochplatte glatt für Gitterstab • FR Plaque lisse pour tige grille • ES PLANCHA LISA POR RED DE VARILLA cm. 36x 39			210,00 11 / 0,01
PRFT/9 09590453	PIASTRA RIGATA per GRIGLIA IN TONDINO EN Grooved griddle plate for grid rod • DE Fortkochplatte gerillt für Gitterstab • FR Plaque nervurée pour tige grille • ES PLANCHA ESTRIADA POR RED DE VARILLA cm. 36x 39			280,00 11 / 0,01

ACCESSORI

MOD. COD. DESCRIZIONE/DESCRIPTION/BEZEICHNUNG/DESCRIPTION/DESCRIPCIÓN DIMENSIONI/DIMENSIONS/ABMESSUNGEN/DIMENSIONS/DIMENSIONES POTENZA/POWER/LEISTUNG/PUISSANCE/POTENCIA VOLTAGGIO/VOLTAGE/SPANNUNG/VOLTAGE/VOLTAJE 0,25 kW kcal/h 230V~ 50/60 Hz PREZZO/PRICE € PREIS/PRIX/PRECIO € KG / M³

533009200 GRIGLIA DI RIDUZIONE
EN Reduction • **DE** Reduzierstern • **FR** Grille de réduction • **ES** REJILLA DE REDUCCIÓN
 cm. 25x 25 **43,00**
 0.2 / 0,00

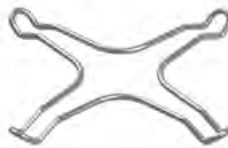

KIT-WOK
 09580040 KIT WOK - fiamma verticale - solo su bruciatore da 10 kW e griglie in ghisa
EN KIT WOK - vertical flame - only for 10 kW burner and cast iron grills
 • **DE** KIT WOK - vertikaler Flamme - nur 10 kW-Brenner und Roste aus Gusseisen • **FR** KIT WOK - verticale de la flamme - seulement 10 kW brûleur et grilles en fonte • **ES** KIT WOK - LLAMA VERTICAL - SÓLO 10 KW QUEMADOR Y PARRILAS DE HIERRO COLADO
 cm. Ø 26x 16h **456,00**
 5 / 0,02



RV
 08660410 RISCALDANTE VANO
EN Heater for cabinet • **DE** Heizer für Schrankelement • **FR** Réchauffeur pour armoire • **ES** ELEMENTO DE CALEFACCIÓN PARA ARMARIO NEUTRO
 cm. 32x 48,5x 8h **975,00**
 8 / 0,08

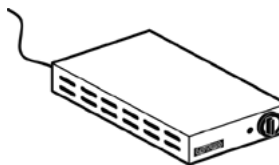

RRV-114
 034F0401 RIPIANO (no per BM-114E)
EN Shelf (no for BM-114E) • **DE** Zwischenboden (nein für BM-114E) • **FR** Etagère (no pour BM-114E) • **ES** ESTANTE (NO PARA BM-114E)
 cm. 34x 95x 10h **521,00**
 7 / 0,05



RRV-118
 034F0801 RIPIANO (no per PC-118G)
EN Shelf (no for PC-118G) • **DE** Zwischenboden (nein für PC-118G) • **FR** Etagère (no pour PC-118G) • **ES** ESTANTE (NO PARA PC-118G)
 cm. 74x 95x 10h **995,00**
 13 / 0,10



RRV-1110
 034F1001 RIPIANO
EN Shelf • **DE** Abstellbrett • **FR** Etagère • **ES** ESTANTE
 cm. 94x 95x 10h **1.409,00**
 16 / 0,12

RRV-558
 03450801 cm. 74x 46x 10h **649,00**
 7 / 0,05



TPA-11
 035G0001 TESTATA CHIUSURA PIANO 2 LATI NON PER FUOCHI GAS (in dotazione 1 pezzo per apparecchio)
EN Head end filler strip 2 sides, no for gas burner (1 piece included in each machine) • **DE** Abschluss-Element 2 seiten, nein für Gasbrenner (1 Stück in jeder Maschine enthalten) • **FR** Élément de jonction 2 cotés, non pour brûleur à gaz (1 pièce incluse dans chaque machine) • **ES** CHAPA DE CIERRE 2 LADOS, NO PARA QUEMADOR GAS (1 PIEZA INCLUIDA EN CADA EQUIPO)
 cm. 0,2x 110x 5h **103,00**
 2 / 0,00

TPC-11
 035G0002 TESTATA CHIUSURA PIANO 2 LATI PER FUOCHI GAS (in dotazione 1 pezzo per apparecchio)
EN Head end filler strip 2 sides, for gas burner (1 piece included in each machine) • **DE** Abschluss-Element 2 seiten, für Gasbrenner (1 Stück in jeder Maschine enthalten) • **FR** Élément de jonction 2 cotés, pour brûleur à gaz (1 pièce incluse dans chaque machine) • **ES** CHAPA DE CIERRE 2 LADOS, PARA QUEMADOR GAS (1 PIEZA INCLUIDA EN CADA EQUIPO)
 cm. 0,2x 110x 5h **103,00**
 2 / 0,00



ACCESSORI

MOD. _____ DESCRIZIONE/DESCRIPTION/BEZEICHNUNG/DESCRIPTION/DESCRIPCIÓN POTENZA/POWER/LEISTUNG/PUISSANCE/POTENCIA $\frac{kW}{kcal/h}$ $\frac{kW}{V\sim}$ PREZZO/PRICE €
 COD. _____ DIMENSIONI/DIMENSIONS/ABMESSUNGEN/DIMENSIONS/DIMENSIONES VOLTAGGIO/VOLTAGE/SPANNUNG/VOLTAGE/VOLTAJE Hz PREIS/PRIX/PRECIO €
 KG / M³

TPAC-11
035G0003
TESTATA CHIUSURA PIANO 2 LATI PER FUOCHI GAS DA 1 LATO
EN Head end filler strip 2 sides, with gas burner in 1 side • **DE** Abschluss-Element 2 seiten, mit Gasbrenner in 1 Seite • **FR** Elément de jonction 2 cotés, avec brûleur à gaz sur 1 côté • **ES CHAPA DE CIERRE 2 LADOS, CON QUEMADOR GAS EN 1 LADO**
cm. 0,2x 110x 5h



103,00
2 / 0,00

TPA-55
03560001
TESTATA CHIUSURA PIANO 1 LATO NON PER FUOCHI GAS (in dotazione 1 pezzo per apparecchio)
EN Head end filler strip 1 side, no for gas burner (1 piece included in each machine) • **DE** Abschluss-Element 1 seite, Nein für Gasbrenner (1 Stück in jeder Maschine enthalten) • **FR** Elément de jonction 1 cote, non pour brûleur à gaz (1 pièce incluse dans chaque machine) • **ES CHAPA DE CIERRE 1 LADO, NO PARA QUEMADOR GAS (1 PIEZA INCLUIDA EN CADA EQUIPO)**
cm. 0,2x 55x 5h



75,00
1 / 0,00

TMA-11
035E1100
TESTATA 2 LATI SERIE 110
EN Head 2 sides S110 • **DE** Abschluss element seiten S110 • **FR** Element de jonction 2 cotés S110 • **ES EMBELLECEDOR 2 LADOS S110**
cm. 0,2x 110x 74h



519,00
13 / 0,04

TMTA-11
035E1120
TESTATA TAMBURATA 2 LATI SERIE 110, con stesso profilo linea frontale
EN Head 2 sides S110, with the same front line profile • **DE** Abschluss element seiten S110, mit dem gleichen Frontlinienprofil • **FR** Element de jonction 2 cotés S110, avec le même profil de ligne • **ES EMBELLECEDOR 2 LADOS S110, CON EL MISMO PERFIL DE LÍNEA FRONTAL**
cm. 7,5x 110x 74h



1.528,00
24 / 0,24

ZB
01410000
ZOCOLATURA BASE
EN FRONT PLINTH • **DE** GRUNDSOCKEL • **FR** PLINTHE FRONTAL • **ES ZOCCOLOS BASE**
€/m x cm. 15h



154,00
/

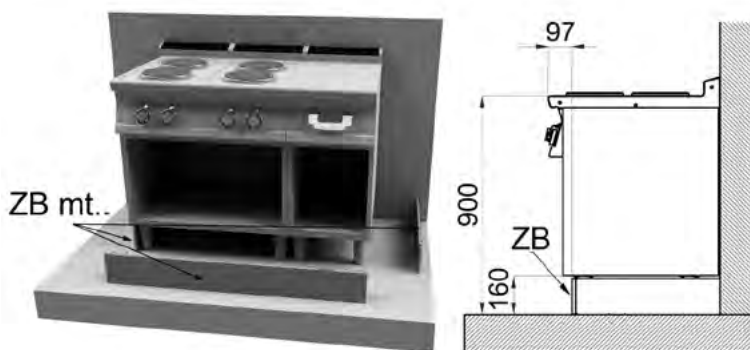



MONOBLOCK & ENCASTRABLES

لوتس®

FREEBLOCK / FREELOTUS



FREEBLOCK



FREEBLOCK 5.0

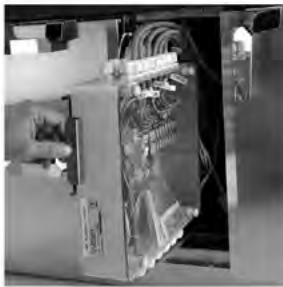

LED optional



FREEBLOCK / FREELOTUS

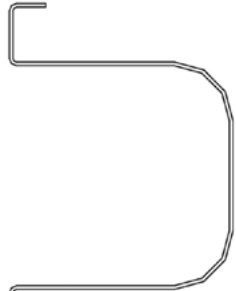
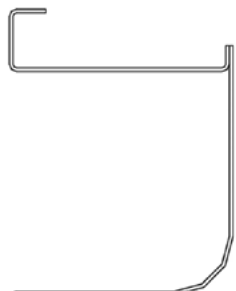
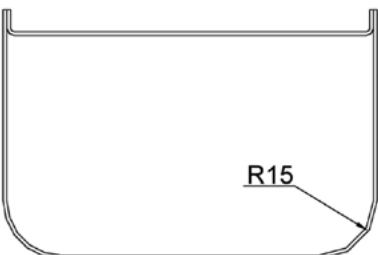
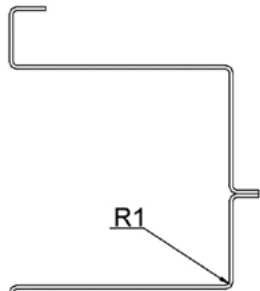
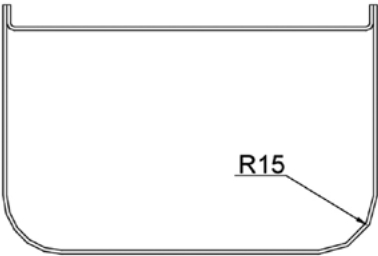
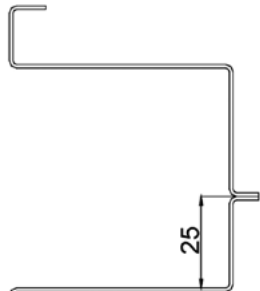
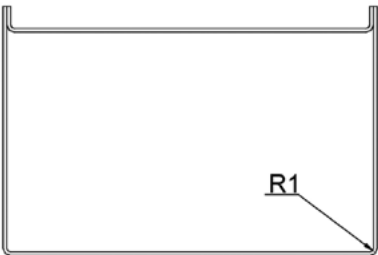
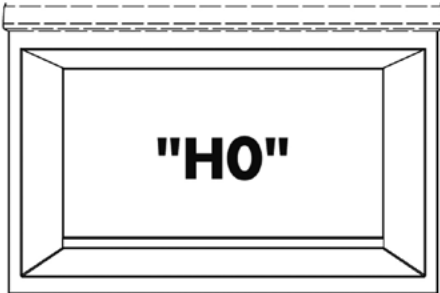

FREEBLOCK

MOD. _____
COD. _____

DESCRIZIONE/DESCRIPTION/BEZEICHNUNG/DESCRIPTION/DESCRIPCIÓN
DIMENSIONI/DIMENSIONS/ABMESSUNGEN/DIMENSIONS/DIMENSIONES

POTENZA/POWER/LEISTUNG/PUISSANCE/POTENCIA
VOLTAGGIO/VOLTAGE/SPANNUNG/VOLTAGE/VOLTAJE

⊕kW kcal/h
⊖kW V- Hz

PREZZO/PRICE €
PREIS/PRIX/PRECIO €
KG / M³

FREEBLOCK Il monoblocco FREEBLOCK è composto da struttura interna, vani igienici e non, pannello comandi, piano ecc... tutto è interamente realizzato in acciaio inox 18/10 finemente satinato, con particolari cromati, il piano viene infine spazzolato fino ad ottenere un effetto finale antigraffio.

EN The monoblock FREEBLOCK is made up internal frame, hygienic and not hygienic compartments, control panel, top etc. ... everything is made entirely of stainless steel 18/10 with fine satin finish, with chromed details, the top is brushed to obtain a scratchproof effect.

DE Das Monoblock FREEBLOCK besteht aus einer internen Struktur, Hygiene oder normale Unterschränke, Bedienungsblende, Oberfläche kratzfest... komplett aus CNS 18/10 mit feinem Schliff, ergänzt mit verchromten Teilen.

FR Le monobloc FREEBLOCK se compose de structure interne, avec vanes hygiéniques ou pas, panneau de commandes, plan, etc... tout est fait entièrement en acier inoxydable 18/10 satiné avec des touches de chrome. Le plan est ensuite brossé pour obtenir un effet anti-rayures.

ES EL MONOBLOC FREEBLOCK SE COMPONE POR UNA ESTRUCTURA INTERNA, ARMARIOS NORMALES Ó HIGIÉNICOS, PANEL DE CONTROL, SOBRE DE TRABAJO, ETC... TODO REALIZADO COMPLETAMENTE EN ACERO INOXIDABLE 18/10 CON ACABADO SATINADO FINO CON DETALLES CROMADOS, EL PLANO DE TRABAJO SUFICIENTEMENTE SATINADO HASTA OBTENER UN EFECTO A PRUEBA DE ARAÑAZOS.



FREEBLOCK

MOD. _____
COD. _____

DESCRIZIONE/DESCRIPTION/BEZEICHNUNG/DESCRIPTION/DESCRIPCIÓN
DIMENSIONI/DIMENSIONS/ABMESSUNGEN/DIMENSIONS/DIMENSIONES

POTENZA/POWER/LEISTUNG/PUISSANCE/POTENCIA
VOLTAGGIO/VOLTAGE/SPANNUNG/VOLTAGE/VOLTAJE

⚡ kW
kcal/h

⚡ kW
V~
Hz

PREZZO/PRICE €
PREIS/PRIX/PRECIO €
KG / M³

FREEBLOCK 5_0 FREEBLOCK 5.0. Il piano è un pezzo unico con fianchi che arrivano a terra e sono portanti, tutto in acciaio inox AISI 304 CrNi 18/10 con satinatura antigraffio e spessore da 3 mm, rinforzato con traverse avvitata. Struttura e telaio interamente portanti. Gli elementi drop-in possono essere installati incassati e siliconati o essere saldati interamente al piano. Installazione dei modelli a induzione con vetro siliconato a livello del piano senza telaio d'ingombro. Previsto vano con griglia e filtro smontabile per l'aerazione del generatore induzione. Porte tamburate e saldate, rinforzate all'interno con polistirolo ad alta densità. È presente un vano tecnico specifico, di facile ispezione, per la scatola elettrica che contiene tutti i collegamenti. Cassetti e porte dotate di rallentatore in chiusura. Possibilità di vani illuminati da strip led che si attiva all'apertura della porta relativa tramite "microswitch".



EN FREEBLOCK 5.0. The top is a single piece, the sides go down to the ground and are load-bearing. It's entirely in stainless steel AISI 304 CrNi 18/10, 3 mm thick with scratch-proof satin finish, reinforced with bolted crossbars. Structure and frame are entirely load-bearing. The drop-in elements can be installed as recessed and silicone fastened or they can be welded entirely to the top. Installation of the induction models with silicon-coated glass at the level of the top without a cumbersome frame. Includes compartment with grill and removable filter for the aeration of the induction generator. All the doors are hollow core and entirely welded, reinforced internally with high-density polystyrene. A specific technical compartment is present, allowing easy inspection of the electrical box that contains all the connections. Drawers and doors equipped with soft closure. Possibility of compartments illuminated by strip LEDs that turn on at the opening of the relative door by "microswitch".

• **DE** FREEBLOCK 5.0. Die Platte ist aus einem einzigen Stück mit bis zum Boden tragenden Seiten, alle aus Edelstahl AISI 304 CrNi 18/10 mit kratzfester, satinierter Oberfläche und einer Dicke von 3 mm, verstärkt mit verschraubten Querstreben. Struktur und Rahmen vollständig tragend. Die Drop-in-Elemente können versenkt und silikonisiert oder vollständig mit dem Boden verschweißt werden. Installation der Induktionsmodelle mit silikonisiertem Glas auf der Höhe der Oberseite ohne Rahmen. Ausgestattetes Fach mit Gitter und abnehmbarem Filter zur Belüftung des Induktionsgenerators. Türen wabenförmig gekernt und geschweißt, innen mit hochdichtem Polystyrol verstärkt. Es gibt einen speziellen, leicht zu inspizierenden Technikraum für den Elektrokasten, der alle Anschlüsse enthält. Schubladen und Türen, die mit einer Schließverzögerung ausgestattet sind. Möglichkeit von Fächern, die von Streifen-LEDs beleuchtet werden, die beim Öffnen der entsprechenden Tür mit Hilfe eines "microswitch" aktiviert werden.

• **FR** FREEBLOCK 5.0. Le plan est une pièce unique avec les côtés qui arrivent jusqu'à terre et portants, le tout en acier inox AISI 304 CrNi 18/10 satiné anti-rayures et épaisseur de 3 mm, renforcé par des traverses vissées. Structure et châssis entièrement portants. Les éléments drop-in peuvent être installés encastrés et siliconés ou être soudés entièrement au plan. Installation des modèles à induction avec verre siliconé au niveau du plan sans structure encombrante. Un compartiment avec grille est prévu, ainsi qu'un filtre démontable pour l'aération du générateur à induction. Portes alvéolaires et soudées, renforcées à l'intérieur par du polystyrène à haute densité. Il y a un compartiment technique spécifique, d'inspection facile, pour le boîtier électrique qui contient tous les raccordements. Tiroirs et portes équipés de fermeture amortie. Possibilité de compartiments éclairés par bande led qui s'active à l'ouverture de la porte relative à travers un "microswitch".

• **ES** FREEBLOCK 5.0. LA PARTE SUPERIOR ES UNA SOLA PIEZA CON LATERALES HASTA EL SUELO QUE SOPORTAN LA CARGA, TODO EN ACERO INOXIDABLE AISI 304 CRNI 18/10 CON ACABADO SATINADO RESISTENTE A LOS ARAÑAZOS Y 3 MM DE ESPESOR, REFORZADO CON TRAVESAÑOS ATORNILLADOS. ESTRUCTURA Y ARMAZÓN QUE SOPORTAN COMPLETAMENTE LA CARGA. LOS ELEMENTOS DROP-IN PUEDEN INSTALARSE EMPOTRADOS Y SILICONADOS O PUEDEN SOLDARSE COMPLETAMENTE AL SUELO. INSTALACIÓN DE LOS MODELOS DE INDUCCIÓN CON VIDRIO SILICONADO A NIVEL DE LA PARTE SUPERIOR SIN MARCO. COMPARTIMENTO PROVISTO DE REJILLA Y FILTRO EXTRAÍBLE PARA LA VENTILACIÓN DEL GENERADOR DE INDUCCIÓN. PUERTAS HUECAS Y SOLDADAS, REFORZADAS POR DENTRO CON POLIESTIRENO DE ALTA DENSIDAD. HAY UN COMPARTIMENTO TÉCNICO ESPECÍFICO, FÁCIL DE INSPECCIONAR, PARA LA CAJA ELÉCTRICA QUE CONTIENE TODAS LAS CONEXIONES. CAJONES Y PUERTAS EQUIPADAS CON RETARDADOR DE CIERRE. POSIBILIDAD DE COMPARTIMENTOS ILUMINADOS POR UNA TIRA DE LEDS QUE SE ACTIVA AL ABRIR LA PUERTA CORRESPONDIENTE MEDIANTE "MICROSWITCH".

• **ES** FREEBLOCK 5.0. LA PARTE SUPERIOR ES UNA SOLA PIEZA CON LATERALES HASTA EL SUELO QUE SOPORTAN LA CARGA, TODO EN ACERO INOXIDABLE AISI 304 CRNI 18/10 CON ACABADO SATINADO RESISTENTE A LOS ARAÑAZOS Y 3 MM DE ESPESOR, REFORZADO CON TRAVESAÑOS ATORNILLADOS. ESTRUCTURA Y ARMAZÓN QUE SOPORTAN COMPLETAMENTE LA CARGA. LOS ELEMENTOS DROP-IN PUEDEN INSTALARSE EMPOTRADOS Y SILICONADOS O PUEDEN SOLDARSE COMPLETAMENTE AL SUELO. INSTALACIÓN DE LOS MODELOS DE INDUCCIÓN CON VIDRIO SILICONADO A NIVEL DE LA PARTE SUPERIOR SIN MARCO. COMPARTIMENTO PROVISTO DE REJILLA Y FILTRO EXTRAÍBLE PARA LA VENTILACIÓN DEL GENERADOR DE INDUCCIÓN. PUERTAS HUECAS Y SOLDADAS, REFORZADAS POR DENTRO CON POLIESTIRENO DE ALTA DENSIDAD. HAY UN COMPARTIMENTO TÉCNICO ESPECÍFICO, FÁCIL DE INSPECCIONAR, PARA LA CAJA ELÉCTRICA QUE CONTIENE TODAS LAS CONEXIONES. CAJONES Y PUERTAS EQUIPADAS CON RETARDADOR DE CIERRE. POSIBILIDAD DE COMPARTIMENTOS ILUMINADOS POR UNA TIRA DE LEDS QUE SE ACTIVA AL ABRIR LA PUERTA CORRESPONDIENTE MEDIANTE "MICROSWITCH".



FREEBLOCK

MOD. _____
COD. _____

DESCRIZIONE/DESCRIPTION/BEZEICHNUNG/DESCRIPTION/DESCRIPCIÓN
DIMENSIONI/DIMENSIONS/ABMESSUNGEN/DIMENSIONS/DIMENSIONES

POTENZA/POWER/LEISTUNG/PUISSANCE/POTENCIA
VOLTAGGIO/VOLTAGE/SPANNUNG/VOLTAGE/VOLTAJE

⚡kw kcal/h ⚡kw V~ Hz

PREZZO/PRICE €
PREIS/PRIX/PRECIO €
KG / M³

FREEBLOCK 5_0 B Versione FREEBLOCK 5.0 B, con piano in pezzo unico fino alla copertura del pannello comandi e fianchi terminali che arrivano a terra separati. Per facilitarne il trasporto e la movimentazione pur mantenendo l'estetica del FREEBLOCK 5.0

EN FREEBLOCK 5.0 B version, that is, with a single piece top up to the level of the control panel and separate sides that come to the ground . To facilitate transport and handling while maintaining the aesthetics of FREEBLOCK 5.0 • **DE** FREEBLOCK Version 5.0 B, mit fugenfreiem Oberteil bis zur Höhe des Bedienfelds hinuntergezogen und separaten Seitenteilen die bis zum Boden reichen. Dies erleichtert den Transport und die Handhabung unter Beibehaltung der Ästhetik von FREEBLOCK 5.0 • **FR** Version FREEBLOCK 5.0 B, c'est-à-dire avec un haut monobloc jusqu'au niveau du panneau de commande et des côtés latéraux séparés qui atteignent le sol. Pour faciliter le transport et la manutention tout en conservant l'esthétique de FREEBLOCK 5.0 • **ES VERSIÓN FREEBLOCK 5.0 B, ES DECIR, CON UNA SOLA PIEZA QUE SE COMPLETA HASTA EL NIVEL DEL PANEL DE CONTROL Y LATERALES SEPARADOS QUE LLEGAN AL SUELO. PARA FACILITAR EL TRANSPORTE Y LA MANIPULACIÓN MANTENIENDO LA ESTÉTICA DE FREEBLOCK 5.0**



- /

FREEBLOCK 5_0 C Versione FREEBLOCK 5.0 c, con piano in pezzo unico solo superiore con sbordo laterale di cm.7,5, pannello comandi e fiancata tamburata in estetica con il lato frontale.

EN FREEBLOCK 5.0 C version, that is, with a single piece top only with a lateral edge of 7.5 cm, a control panel and a side panel in aesthetics with the front side. • **DE** FREEBLOCK Version 5.0 C, mit fugenfreiem Oberteil und seitlichem Überstand von 7,5 cm. Bedienfeld und doppelwandige Seitenteile in selber Ästhetik wie die Gerätefront. • **FR** Version FREEBLOCK 5.0 C, c'est-à-dire avec un dessus monobloc uniquement avec un bord latéral de 7,5 cm, un panneau de commande et un panneau latéral en esthétique avec la face avant. • **ES VERSIÓN FREEBLOCK 5.0 C, ES DECIR, CON UNA PARTE SUPERIOR DE UNA SOLA PIEZA CON UN BORDE LATERAL DE 7,5 CM, UN PANEL DE CONTROL Y LATERAL EN ESTÉTICA CON EL LADO FRONTAL**



- /

PTM-POTS struttura portategami per monoblocco (realizzazioni a progetto)
EN pot rack structure for monoblock (realizations for project) • **DE** Ablagerost für Kochwerkzeuge, für monoblock (Realisierunge im Projekt) • **FR** structures porte casseroles pour monobloc (réalisations en projet) • **ES ESTRUCTURAS SUPERIORES PORTA CAZUELAS PARA MONOBLOC (LOGROS EN EL PROYECTO)**
cm. ...x 70x 76,5h



- /

PTM-POTS-SL struttura portategami per monoblocco con abbassamento portasalamandra (realizzazioni a progetto)
EN pot rack structure for monoblock with salamander support (realizations for project) • **DE** Ablagerost für Kochwerkzeuge, für monoblock mit Salamander Konsolen (Realisierunge im Projekt) • **FR** structures porte casseroles pour monobloc avec porte salamandres (réalisations en projet) • **ES ESTRUCTURAS SUPERIORES PORTA CAZUELAS PARA MONOBLOC CON PORTA SALAMANDRA (LOGROS EN EL PROYECTO)**
cm. ...x 70x 76,5h



- /

PSM-SL Supporto salamandra per monoblocco
EN salamander support, for monoblock • **DE** Salamander Konsolen, für monoblock • **FR** porte salamandres pour monobloc • **ES PORTA SALAMANDRA PARA MONOBLOC**
cm. 60x 50x 40h



983,00
10 / 0,20

FREEBLOCK

MOD. _____ DESCRIZIONE/DESCRIPTION/BEZEICHNUNG/DESCRIPTION/DESCRIPCIÓN POTENZA/POWER/LEISTUNG/PUISSANCE/POTENCIA $\frac{kW}{kcal/h}$ $\frac{kW}{V\sim}$ PREZZO/PRICE €
 COD. _____ DIMENSIONI/DIMENSIONS/ABMESSUNGEN/DIMENSIONS/DIMENSIONES VOLTAGGIO/VOLTAGE/SPANNUNG/VOLTAGE/VOLTAJE Hz PREIS/PRIX/PRECIO €
 KG / M³

SCHUKO
 537060400 presa elettrica schuko 230V~ / 16A in plastica grigia IP44
EN Schuko electrical outlet, 230V~ / 16A gray plastic IP44 • **DE** Schuko Steckdose, 230V~ / 16A grauer Kunststoff IP44 • **FR** prise de courant Schuko, 230V~ / 16A plastique gris IP44 • **ES TOMA DE CORRIENTE ELÉCTRICA SCHUKO, 230V~ / 16A DE PLÁSTICO GRIS IP44**
cm. 9x 9x 3



228,00
 0.3 / 0,00

SCHUKOS
 537061600 presa elettrica schuko 230V~ / 16A in metallo cromato IP54
EN Schuko electrical outlet, 230V~ / 16A chromed metal IP54 • **DE** Schuko Steckdose, 230V~ / 16A métal chromé IP54 • **FR** prise de courant Schuko, 230V~ / 16A verchromtes Metall IP54 • **ES TOMA DE CORRIENTE ELÉCTRICA SCHUKO, 230V~ / 16A DE METAL CROMADO IP54**
cm. 8x 8x 4,5



481,00
 0.3 / 0,00

CEAMS
 19580012 colonna erogazione acqua calda e fredda con canna snodabile, per monoblocco
EN Pillar tap, hot and cold water • **DE** Mischbatterie, Warm- und Kaltwasser • **FR** Colonne de distribution eau froide et chaude • **ES RUBINETO DISPENSADOR DE AGUA CALIENTE Y FRÍA**
cm. 12x 12x 68h



769,00
 6 / 0,03

TOWER
 1958001A colonna di servizio: corpo inox cm.12x12x25h con 2 prese elettriche mod: SCHUKOS, profilo ferma utensili/mixer con bacinella GN1/6 inferiore, rubinetto acqua calda e fredda con canna snodabile con antigoccia.
EN Service Tower: inox body cm.12x12x25h with 2 electrical outlet mod: SCHUKOS, bracket for tools/mixer block with GN1/6 container inferior, Pillar tap with hot and cold water with dripless.
 • **DE** : Servicemöbel: Körper aus rostfreiem Stahl cm.12x12x25h mit 2 Steckdosen Mod: SCHUKOS, Werkzeug-/Mischhalterprofil mit GN1/6 Bodenbecken, Warm- und Kaltwasserhahn mit Gelenkrohr mit Tropfschutz. • **FR** colonne de service : corps inox cm.12x12x25h avec 2 prises électriques mod : SCHUKOS, profil bloque ustensiles/ mixer avec bac GN1/6 inférieur, robinet eau chaude et froide avec douchette et système anti-gouttes. • **ES COLUMNA DE SERVICIO: CUERPO DE ACERO INOXIDABLE CM.12X12X25H CON 2 TOMAS ELÉCTRICAS MOD: SCHUKOS, PERFIL PORTAHERRAMIENTAS/MEZCLADOR CON BANDEJA INFERIOR GN1/6, GRIFO DE AGUA CALIENTE Y FRÍA CON TUBO ARTICULADO CON ANTIGOTEÓ.**
cm. 21x 27x 67h



2.391,00
 13 /

MP240VV
 _1534760 MIXER AD IMMERSIONE mini. Velocità variabile da 2000 a 12500 giri/ min. Coltello, campana e fusto in inox lungo 240 mm.
EN MIXER mini. Speed variator 2000/12500 rpm, inox The foot, blade and tube 240mm. • **DE** Stabmixer mini. Geschwindigkeitsvariator 2000/12500 rpm, Messer und Stab 240mm aus Edelstahl. • **FR** Mixer Plongeant mini. variateur de vitesse 2000/12500 rpm, Couteau et tube en inox 240mm. • **ES TRITURADORES MINI. VELOCIDAD VARIABLE DE 2000 A 12.500 RPM. CUCHILLA, CAMPANA Y TUBO DE ACERO INOXIDABLE DE UNA LONGITUD DE 240 MM.**
cm. 15x 15x 54h



$\frac{kW}{kcal/h}$ 0,29 KW _____ **649,00**
 $\frac{kW}{V\sim}$ 230V~ _____ 2.5 / 1,00
 Hz 50 Hz

FREEBLOCK

MOD. _____
COD. _____

DESCRIZIONE/DESCRIPTION/BEZEICHNUNG/DESCRIPTION/DESCRIPCIÓN
DIMENSIONI/DIMENSIONS/ABMESSUNGEN/DIMENSIONS/DIMENSIONES

POTENZA/POWER/LEISTUNG/PUISSANCE/POTENCIA
VOLTAGGIO/VOLTAGE/SPANNUNG/VOLTAGE/VOLTAJE

⚡ kW _____
kcal/h _____
V~ _____
Hz _____

PREZZO/PRICE €
PREIS/PRIX/PRECIO €
KG / M³

MPFRUSTA Frusta per mixer MP240
_6027333 **EN** Whip for MP240 • **DE** Peitsche für MP240 • **FR** fouet pour MP240
• **ES BATIDOR PARA MP240**



270,00
0.5 / 0,00

BMD-64EM BAGNOMARIA MONOFASE Vasca per GN 1/1 h.15
26050410 **EN** Bain marie singlephase - Bowl for GN 1/1 h.15 • **DE** Wasserbäder einphasig - Becken GN 1/1 h.15 • **FR** Bain marie monophasé - Cuve GN 1/1 h.15 • **ES BAÑO DE MARÍA MONOFÁSICO - CUBA PARA GN 1/1 15H**
cm. 40x 60x 30h



⚡ 2,1 kW _____ **1.201,00**
230V~ _____ 18 / 0,13
50/60 Hz _____

BMD-68ET BAGNOMARIA TRIFASE Vasca per GN 2/1 h.15
26050830 **EN** Bain marie threephase - Bowl for GN 2/1 h.15 • **DE** Wasserbäder Dreiphasig - Becken GN 2/1 h.15 • **FR** Bain marie triphasé - Cuve GN 2/1 h.15 • **ES BAÑO DE MARÍA TRIFÁSICO. - CUBA PARA GN 2/1 15H**
cm. 80x 60x 30h



⚡ 4,2 kW _____ **1.987,00**
400V~2N _____ 40 / 0,22
230V~3 _____
50/60 Hz _____

BMD-82EM BAGNOMARIA MONOFASE Vasca per 7xGN 1/9 h15
28050210 **EN** Bain marie singlephase - Bowl for 7xGN 1/9 h.15 • **DE** Wasserbäder einphasig - Becken für 7xGN 1/9 h.15 • **FR** Bain marie monophasé - Cuve pour 7xGN 1/9 h.15 • **ES BAÑO DE MARÍA MONOFÁSICO - CUBA PARA 7XGN 1/9 H.15**
cm. 20x 80x 30h



⚡ 1,65 kW _____ **1.584,00**
230V~ _____ 16 / 0,17
50/60 Hz _____

BMD-84EM BAGNOMARIA MONOFASE Vasca per GN 1/1 + GN 1/3 h15
28050410 **EN** Bain marie singlephase - Bowl for GN 1/1 + GN 1/3 h.15 • **DE** Wasserbäder einphasig - Becken GN 1/1 + GN 1/3 h.15 • **FR** Bain marie monophasé - Cuve GN 1/1 + GN 1/3 h.15 • **ES BAÑO DE MARÍA MONOFÁSICO - CUBA PARA GN 1/1 + GN 1/3 15H**
cm. 40x 80x 30h



⚡ 2,85 kW _____ **1.921,00**
230V~ _____ 21 / 0,23
50/60 Hz _____

BSD-64EM CONTENITORE CALDO CON INFRAROSSO MONOFASE Vasca cm.
26040410 30,5x51x16,5h con falsofondo forato
EN Fry dump singlephase with infra-red heater. Bowl cm. 30,5x51x16,5h with perforated double bottom • **DE** Frittenwanne Einphasig mit Infrarotstrahler. Becke cm. 30,5x51x16,5h mit gelochtem Bodenrost • **FR** Silo a frites monophasé avec infrarouge. Cuve cm 30,5x51x16,5h avec doublefond perforé. • **ES CONTENEDOR CALIENTE POR INFRARROJO MONOFÁSICO. CUBA CM. 30,5X51X16,5H CON FALSO FONDO AGUJEREADO**
cm. 40x 60x 25h



⚡ 1,47 kW _____ **1.232,00**
230V~ _____ 20 / 0,13
50/60 Hz _____

BRASIERE FISSE MULTIFUNZIONE ELETTRICHE 60

MOD. _____
COD. _____

DESCRIZIONE/DESCRIPTION/BEZEICHNUNG/DESCRIPTION/DESCRIPCIÓN
DIMENSIONI/DIMENSIONS/ABMESSUNGEN/DIMENSIONS/DIMENSIONES

POTENZA/POWER/LEISTUNG/PUISSANCE/POTENCIA
VOLTAGGIO/VOLTAGE/SPANNUNG/VOLTAGE/VOLTAJE

⚡ kW kcal/h ⚡ kw V~ Hz

PREZZO/PRICE € PREIS/PRIX/PRECIO € KG / M³

BRFD-64ET 26070433
BRASIERA FISSA MULTIFUNZIONALE ELETTRICA Vasca cm. 30x51x10h
EN Electric multi-function fixed braising pan - Bowl cm. 30x51x10h
• **DE** Elektrische Multifunktionsbratpfanne Fest Becken cm. 30x51x10h
• **FR** Sauteuse fixe multifonction électrique - Cuve cm. 30x51x10h
• **ES SARTEN FIJA MULTIFUNCIÓN ELÉCTRICA - CUBA CM. 30X51X10H**
cm. 40x 60x 28h



⚡ 4 kW 2.716,00
400V~2N 45 / 0,13
230V~3
50/60 Hz

BRFD-68ET 26070833
BRASIERA FISSA MULTIFUNZIONALE ELETTRICA Vasca cm. 70x51x10h
EN Electric multi-function fixed braising pan - Bowl cm. 70x51x10h
• **DE** Elektrische Multifunktionsbratpfanne Fest Becken cm. 70x51x10h
• **FR** Sauteuse fixe multifonction électrique - Cuve cm. 70x51x10h
• **ES SARTEN FIJA MULTIFUNCIÓN ELÉCTRICA - CUBA CM. 70X51X10H**
cm. 80x 60x 28h



⚡ 8 kW 4.796,00
400V~3N 65 / 0,32
50/60 Hz

BRFD-84ET 28070433
BRASIERA FISSA MULTIFUNZIONALE ELETTRICA Vasca cm. 30x68x10h
EN Electric multi-function fixed braising pan - Bowl cm. 30x68x10h
• **DE** Elektrische Multifunktionsbratpfanne Fest Becken cm. 30x68x10h
• **FR** Sauteuse fixe multifonction électrique - Cuve cm. 30x68x10h
• **ES SARTEN FIJA MULTIFUNCIÓN ELÉCTRICA - CUBA CM. 30X68X10G**
cm. 40x 80x 28h



⚡ 5,2 kW 2.991,00
400V~2N 60 / 0,23
50/60 Hz

CPD-64ET 26100430
CUOCPASTA TRIFASE LT. 25 Vasca cm. 30,5x33,5x32,7h. Rubinetto carico acqua, sfioratore + scarico a pavimento. (CESTI ESCLUSI)
EN Pasta cooker threephase 25 lts. Tank cm. 30,5x33,5x32,7h. Water loading cock + overflow device and floor draining (BASKETS EXCLUDED)
• **DE** Nudelkocher Dreiphasig lt. 25. Becken cm. 30,5x33,5x32,7h. Wasserlauf-Hahn, + Überlauf-Vorrichtung und Ablauf am Boden (KORB AUSGESCHLOSSEN) • **FR** Cuiseur à pates triphase lt. 25. Cuve cm.30,5x33,5x32,7h. Robinet d'arrivée d'eau trop plein + système de vidange au sol (PANIERS EXCLUS) • **ES CUECE PASTA TRIFÁSICO LT. 25 - CUBA CM. 30,5X33,5X32,7H. GRIFO CARGA AGUA + VERTEDERO + DESCARGA A PAVIMENTO (CESTAS EXCLUIDAS)**
cm. 40x 60x 51h



⚡ 7,8 kW 2.375,00
400V~3N 22 / 0,24
50/60 Hz

COMBINAZIONI

- Combinations / • Zusammenstellungen
- Combinaisons / • Combinación múltiple



CUOCIPASTA ELETTRICI 60

MOD. _____
COD. _____

DESCRIZIONE/DESCRIPTION/BEZEICHNUNG/DESCRIPTION/DESCRIPCIÓN
DIMENSIONI/DIMENSIONS/ABMESSUNGEN/DIMENSIONS/DIMENSIONES

POTENZA/POWER/LEISTUNG/PUISSANCE/POTENCIA
VOLTAGGIO/VOLTAGE/SPANNUNG/VOLTAGE/VOLTAJE

⚡ kW _____
kcal/h _____
V~ _____
Hz _____

PREZZO/PRICE € _____
PREIS/PRIX/PRECIO € _____
KG / M³ _____

CPAD-64ET CUOCIPASTA TRIFASE LT. 25 Vasca cm. 30,5x33,5x32,7h. Carico acqua automatico con sensore di livello - sfioratore + scarico a pavimento (CESTI ESCLUSI)
26100435

EN Pasta cooker threephase 25 lts. Tank cm. 30,5x33,5x32,7h. Automatic Water loading with level sensor - overflow device and floor draining (BASKETS EXCLUDED) • **DE** Nudelkocher Dreiphasig Lt. 25. Becken cm. 30,5x33,5x32,7h. Automatische Wasser Beladung mit Niveauregulierung + Überlauf-Vorrichtung und Ablauf am Boden (KORB AUSGESCHLOSSEN) • **FR** Cuiseur à pates triphase Lt. 25. Cuve cm.30,5x33,5x32,7h. Chargement automatique de l'eau avec sensor de niveau, trop plein Système de vidange au sol (PANIERS EXCLUS) • **ES CUECE PASTA TRIFÁSICO LT. 25 - CUBA CM. 30,5X33,5X32,7H. CARGA AUTOMÁTICA DE AGUA CON SENSOR DE NIVEL + VERTEDERO + DESCARGA A PAVIMENTO. (CESTAS EXCLUIDAS)**
cm. 40x 60x 51h



⚡ 7,8 kW _____ **2.872,00**
400V~3N _____ 22 / 0,24
50/60 Hz _____

COMBINAZIONI

- Combinations / • Zusammenstellungen
- Combinaisons / • Combinación múltiple



CPD-84ET CUOCIPASTA TRIFASE LT. 40 Vasca cm. 30,7x50,9x32,7h. Rubinetto carico acqua, sfioratore + scarico a pavimento (CESTI ESCLUSI)
28100430

EN Pasta cooker threephase 40 lts. Tank cm. 30,7x50,9x32,7h. Water loading tap + overflow device and floor draining (BASKETS EXCLUDED) • **DE** Nudelkocher dreiphasig Lt. 40 - Becken cm. 30,7x50,9x32,7h. Wasserlauf-Hahn + Überlauf-Vorrichtung und Ablauf am Boden (KORB AUSGESCHLOSSEN) • **FR** Cuiseur a pates triphase Lt. 40 Cuve cm.30,7x50,9x32,7h. Robinet d'arrivée d'eau trop plein + système de vidange au sol (PANIERS EXCLUS) • **ES CUECE PASTA TRIFÁSICO LT. 40 - CUBA CM. 30,7X50,9X32,7H. GRIFO CARGA AGUA + VERTEDERO + DESCARGA A PAVIMENTO (CESTAS EXCLUIDAS)**
cm. 40x 80x 51h



⚡ 13,5 kW _____ **2.910,00**
400V~3N _____ 30 / 0,26
50/60 Hz _____

COMBINAZIONI

- Combinations / • Zusammenstellungen
- Combinaisons / • Combinación múltiple

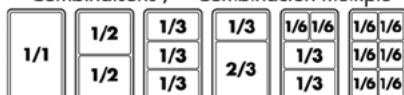

CPAD-84ET CUOCIPASTA TRIFASE LT. 40 Vasca cm. 30,7x50,9x32,7h. Carico acqua automatico con sensore di livello - sfioratore + scarico a pavimento (CESTI ESCLUSI)
28100435

EN Pasta cooker threephase 40 lts. Tank cm. 30,7x50,9x32,7h. Automatic Water loading with level sensor - overflow device and floor draining (BASKETS EXCLUDED) • **DE** Nudelkocher dreiphasig Lt. 40 - Becken cm. 30,7x50,9x32,7h. Automatische Wasser Beladung mit Niveauregulierung + Überlauf-Vorrichtung und Ablauf am Boden (KORB AUSGESCHLOSSEN) • **FR** Cuiseur a pates triphase Lt. 40 Cuve cm.30,7x50,9x32,7h. Chargement automatique de l'eau avec sensor de niveau, trop plein Système de vidange au sol (PANIERS EXCLUS) • **ES CUECE PASTA TRIFÁSICO LT. 40 - CUBA CM. 30,7X50,9X32,7H.CARGA AUTOMÁTICA DE AGUA CON SENSOR DE NIVEL + VERTEDERO + DESCARGA A PAVIMENTO. (CESTAS EXCLUIDAS)**
cm. 40x 80x 51h



⚡ 13,5 kW _____ **3.405,00**
400V~3N _____ 30 / 0,26
50/60 Hz _____

COMBINAZIONI

- Combinations / • Zusammenstellungen
- Combinaisons / • Combinación múltiple



SOLLEVATORE CESTI

MOD. _____
COD. _____

DESCRIZIONE/DESCRIPTION/BEZEICHNUNG/DESCRIPTION/DESCRIPCIÓN
DIMENSIONI/DIMENSIONS/ABMESSUNGEN/DIMENSIONS/DIMENSIONES

POTENZA/POWER/LEISTUNG/PUISSANCE/POTENCIA
VOLTAGGIO/VOLTAGE/SPANNUNG/VOLTAGE/VOLTAJE

⚡ kW
kcal/h

⚡ kw
V~
Hz

PREZZO/PRICE €
PREIS/PRIX/PRECIO
KG / M³

SCCPD-2EM SOLLEVATORE CESTI DA AFFIANCARE AI CUOCIPASTA CPD-64,
26140210 sollevamento automatico temporizzato o manuale, 2 aste
EN basket elevator for pasta cooker CPD-64, automatic timed or manual
lifting, 2 rods • **DE** heben Korbe für Nudelkocher CPD-64, Timed oder
manuelle Heben, 2 Stangen • **FR** soulever des paniers pour cuiseur
a pates CPD-64, soulèvement temporisé ou manuel, 2 tiges • **ES**
LEVANTE CESTAS PARA CUECE PASTA CPD-64, ELEVACIÓN
TEMPORIZADO O MANUAL, 2 BARRAS
cm. 16x 34x 71h



⚡ 0,35 kW **3.498,00**
230V~ 16 / 0,25
50/60 Hz

COMBINAZIONI

- Combinations / • Zusammenstellungen
- Combinaisons / • Combinación múltiple

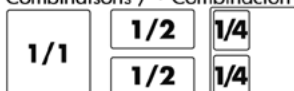

SCCPD-3EM SOLLEVATORE CESTI DA AFFIANCARE AI CUOCIPASTA CPD-84,
28140210 sollevamento automatico temporizzato o manuale, 3 aste
EN basket elevator for pasta cooker CPD-84, automatic timed or manual
lifting, 2 rods • **DE** heben Korbe für Nudelkocher CPD-84, Timed oder
manuelle Heben, 2 Stangen • **FR** soulever des paniers pour cuiseur
a pates CPD-84, soulèvement temporisé ou manuel, 2 tiges • **ES**
LEVANTE CESTAS PARA CUECE PASTA CPD-84, ELEVACIÓN
TEMPORIZADO O MANUAL, 2 BARRAS
cm. 16x 50x 71h



⚡ 0,525 kW **4.716,00**
230V~ 21 / 0,37
50/60 Hz

COMBINAZIONI

- Combinations / • Zusammenstellungen
- Combinaisons / • Combinación múltiple

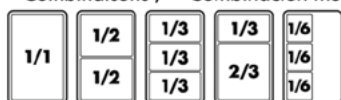

CWKD-64ET GRIGLIA CONTACT - cottura diretta su resistenza in acciaio inox cm.
26080431 27x43 ribaltabile
EN CONTACT Grill threephase - rotatable stainless steel grill cm. 27x43
• **DE** Wurstbrater dreiphasig KONTAKT - Drehbaren Heizelement
aus Edelstahl cm. 27x43 • **FR** Grillade triphase CONTACT - Grille
inox rotatif cm 27x43 • **ES PARRILLA TRIFÁSICO CONTACT -**
PARRILLA GIRATORIA DE ACERO INOX CM 27X43
cm. 40x 60x 30h



⚡ 4,08 KW **3.022,00**
400V~3N 30 / 0,16
50/60 Hz

CWKD-68ET GRIGLIA CONTACT - cottura diretta su resistenza in acciaio inox cm.
26080831 55x43 ribaltabile - 2 zone cottura
EN CONTACT Grill threephase - rotatable stainless steel grill cm. 55x43
- 2 cooking areas • **DE** Wurstbrater dreiphasig KONTAKT - Drehbaren
Heizelement aus Edelstahl cm.. 55x43 - 2 Heizzonen • **FR** Grillade
triphase CONTACT - Grille inox rotatif cm 55x43 - 2 zones de cuisson
• **ES PARRILLA TRIFÁSICO CONTACT - PARRILLA GIRATORIA**
DE ACERO INOX CM 55X43 - 2 ZONAS DE COCCIÓN
cm. 80x 60x 30h



⚡ 8,16 KW **4.103,00**
400V~3N 60 / 0,31
50/60 Hz

CWKD-84ET GRIGLIA CONTACT - cottura diretta su resistenza in acciaio inox cm.
28080431 27x63 ribaltabile
EN CONTACT Grill threephase - rotatable stainless steel grill cm. 27x63
• **DE** Wurstbrater dreiphasig Heizelement
aus Edelstahl cm. 27x63 • **FR** Grillade triphase CONTACT - Grille
inox rotatif cm 27x63 • **ES PARRILLA TRIFÁSICO CONTACT -**
PARRILLA GIRATORIA DE ACERO INOX CM 27X63
cm. 40x 80x 30h



⚡ 5,415 kW **3.534,00**
400V~3N 35 / 0,23
50/60 Hz

FRIGGITRICI ELETTRICHE 60

MOD. _____
COD.

DESCRIZIONE/DESCRIPTION/BEZEICHNUNG/DESCRIPTION/DESCRIPCIÓN
DIMENSIONI/DIMENSIONS/ABMESSUNGEN/DIMENSIONS/DIMENSIONES

POTENZA/POWER/LEISTUNG/PUISSANCE/POTENCIA
VOLTAGGIO/VOLTAGE/SPANNUNG/VOLTAGE/VOLTAJE

⚡ kW kcal/h
⚡ kW V~ Hz

PREZZO/PRICE €
PREIS/PRIX/PRECIO €
KG / M³

F2/8D-64ET FRIGGITRICE TRIFASE LT. 8+8 2 Vasche cm. 14,8x35x32,7h - 2 cesti cm. 12x30x15h - Filtro e coperchio vasca. Produzione patate: 12 kg/h
26090432 **EN** Fryer threephase 8+8 lts - 2 Bowls cm. 14,8x35x32,7h - 2 baskets cm. 12x30x15h. Sieve and lid for pan. Production: 12 kg/h • **DE** Friteuse dreiphasig lt. 8+8 - 2 Becken cm. 14,8x35x32,7h - 2 Korb cm. 12x30x15h. Einlegesieb und Deckel für Becken. Pommes frites: 12 kg/h • **FR** Friteuse triphase lt. 8+8 - 2 Cuve cm. 14,8x35x32,7h - 2 Panier cm. 12x30x15h. Filtre, couvercle pour cuve. Production de pommes frites: 12 kg/h • **ES FREIDORAS TRIFÁSICO 8+8 LT. - 2CUBA CM. 14,8X35X32,7H- 2 CESTA CM. 12X30X15H. FILTRO Y TAPA PARA CUBA. PROD. PATATAS: 12 KG/H cm. 40x 60x 46h**



⚡ 12 kW 3.028,00
400V~3N 30 / 0,23
230V~3
50/60 Hz

F10D-64ET FRIGGITRICE TRIFASE LT. 10 Vasca cm. 22x35x23h - 1 cesto cm. 20x30x10h - Filtro e coperchio vasca. Produzione patate: 10 kg/h
26090430 **EN** Fryer threephase 10 lts - Bowl cm. 22x35x23h - 1 basket cm. 20x30x10h. Sieve and lid for pan. Production: 10 kg/h • **DE** Friteuse dreiphasig lt. 10 - Becken cm. 22x35x23h - 1 Korb cm. 20x30x10h. Einlegesieb und Deckel für Becken. Pommes frites: 10 kg/h • **FR** Friteuse triphase lt. 10 - Cuve cm. 22x35x23h - 1 Panier cm. 20x30x10h. Filtre, couvercle pour cuve. Production de pommes frites: 10 kg/h • **ES FREIDORAS TRIFÁSICO 10 LT. - CUBA CM. 22X35X23H - 1 CESTA CM. 20X30X10H. FILTRO Y TAPA PARA CUBA. PROD. PATATAS: 10 KG/H cm. 40x 60x 39h**



⚡ 7,15 kW 1.678,00
400V~3N 20 / 0,24
230V~3
50/60 Hz

F2/10D-66ET FRIGGITRICE TRIFASE LT. 10+10 2 Vasche cm. 22x35x23h - 2 cesti cm. 20x30x10h - Filtro e coperchio vasca. Produzione patate: 20 kg/h
26090630 **EN** Fryer threephase 10+10 lts - 2 Bowls cm. 22x35x23h - 2 baskets cm. 20x30x10h. Sieve and lid for pan. Production: 20 kg/h • **DE** Friteuse dreiphasig lt. 10+10 - 2 Becken cm. 22x35x23h - 2 Korb cm. 20x30x10h. Einlegesieb und Deckel für Becken. Pommes frites: 20 kg/h • **FR** Friteuse triphase lt. 10+10 - 2 Cuve cm. 22x35x23h - 2 Panier cm. 20x30x10h. Filtre, couvercle pour cuve. Production de pommes frites: 20 kg/h • **ES FREIDORAS TRIFÁSICO 10+10 LT. - 2CUBA CM. 22X35X23H- 2 CESTA CM. 20X30X10H. FILTRO Y TAPA PARA CUBA. PROD. PATATAS: 20 KG/H cm. 60x 60x 39h**



⚡ 14,3 kW 3.072,00
400V~3N 32 / 0,27
230V~3
50/60 Hz

F18D-64ET FRIGGITRICE TRIFASE LT. 18 Vasca cm. 31x34x33h - 1 cesto cm. 28x29x15h - Filtro e coperchio vasca. Produzione patate: 15 kg/h
26090431 **EN** Fryer threephase 18 lts - Bowl cm. 31x34x33h - 1 basket cm. 28x29x15h. Sieve and lid for pan. Production: 15 kg/h • **DE** Friteuse dreiphasig lt. 18 - Becken cm. 31x34x33h - 1 Korb cm. 28x29x15h. Einlegesieb und Deckel für Becken. Pommes frites: 15 kg/h • **FR** Friteuse triphase lt. 18 - Cuve cm. 31x34x33h - 1 Panier cm. 28x29x15h. Filtre, couvercle pour cuve. Production de pommes frites: 15 kg/h • **ES FREIDORAS TRIFÁSICO 18 LT. - CUBA CM. 31X34X33H - 1 CESTA CM. 28X29X15H. FILTRO Y TAPA PARA CUBA. PROD. PATATAS: 15 KG/H cm. 40x 60x 46h**



⚡ 15,9 kW 2.444,00
400V~3N 30 / 0,23
50/60 Hz

F23D-66ET FRIGGITRICE TRIFASE Lt. 23 Vasca cm. 50x35x22h - Cesto cm. 46x30x10h - Filtro e coperchio vasca.
26090631 **EN** Fryer threephase 23 lts - Bowls cm. 50x35x24h - Basket cm. 46x30x10h - Sieve and lid for pan. • **DE** Friteuse dreiphasig lt. 23 - Becken cm. 50x35x22h - Körb cm. 46x30x10h - Einlegesieb und Deckel für Becken. • **FR** Friteuse triphase lt. 23 - Cuve cm. 50x35x22h - Panier cm 46x30x10h - Filtre, couvercle pour cuve. • **ES FREIDORAS TRIFÁSICO 23 LT. CUBA CM. 50X35X22H - CESTA CM. 46X30X10H - FILTRO Y TAPA PARA CUBA. cm. 60x 60x 39h**



⚡ 14,3 kW 2.476,00
400V~3N 31 / 0,27
50/60 Hz













FTLD-64ET Fry-top elettrico liscio, piastra cm.35,5x55
26060431 **EN** Electric Fry-top smooth griddle, plate cm.35,5x55 • **DE** Griddleplatte elektrische glatt, platte cm.35,5x55 • **FR** Plaque électriques lisse, plaque cm.35,5x55 • **ES FRY-TOP ELÉCTRICO LISO, PLANCHA CM.35,5X55 cm. 40x 60x 22h**



⚡ 4,5 kW 1.466,00
400V~3N 30 / 0,13
230V~3
50/60 Hz



FRY-TOP ELETTRICI 60

MOD. COD.	DESCRIZIONE/DESCRIPTION/BEZEICHNUNG/DESCRIPTION/DESCRIPCIÓN DIMENSIONI/DIMENSIONS/ABMESSUNGEN/DIMENSIONS/DIMENSIONES	POTENZA/POWER/LEISTUNG/PUISSANCE/POTENCIA VOLTAGGIO/VOLTAGE/SPANNUNG/VOLTAGE/VOLTAJE	⚡ kW kcal/h	⚡ kw V~ Hz	PREZZO/PRICE € PREIS/PRIX/PRECIO KG / M ³
FTLD-64ETS 26060434	Fry-top elettrico liscio cromato SUPERCHROME (Moca Approved), piastra cm.35,5x55 EN Electric Fry-top smooth chromed griddle SUPERCHROME (Moca Approved), plate cm.35,5x55 • DE Griddleplatte elektrische glatt hartverchromt SUPERCHROME (Moca Approved), platte cm.35,5x55 • FR Plaque électriques lisse chromée SUPERCHROME (Moca Approved), plaque cm.35,5x55 • ES FRY-TOP ELÉCTRICO LISO CROMADO SUPERCHROME (MOCA APPROVED), PLANCHA CM.35,5X55 cm. 40x 60x 22h		⚡ 4,5 kW 400V~3N 230V~3 50/60 Hz		1.832,00 30 / 0,13
					
FTRD-64ET 26060433	Fry-top elettrico rigato, piastra cm.35,5x55 EN Electric Fry-top grooved griddle, plate cm.35,5x55 • DE Griddleplatte elektrische gerillt, platte cm.35,5x55 • FR Plaque électriques nervurée, plaque cm.35,5x55 • ES FRY-TOP ELÉCTRICO ESTRIADO, PLANCHA CM.35,5X55 cm. 40x 60x 22h		⚡ 4,5 kW 400V~3N 230V~3 50/60 Hz		1.470,00 30 / 0,13
					
FTRD-64ETS 26060436	Fry-top elettrico rigato cromato SUPERCHROME (Moca Approved), piastra cm.35,5x55 EN Electric Fry-top grooved chromed griddle SUPERCHROME (Moca Approved), plate cm.35,5x55 • DE Griddleplatte elektrische gerillt hartverchromt SUPERCHROME (Moca Approved), platte cm.35,5x55 • FR Plaque électriques nervurée chromée SUPERCHROME (Moca Approved), plaque cm.35,5x55 • ES FRY-TOP ELÉCTRICO ESTRIADO CROMADO SUPERCHROME (MOCA APPROVED), PLANCHA CM.35,5X55 cm. 40x 60x 22h		⚡ 4,5 kW 400V~3N 230V~3 50/60 Hz		1.911,00 30 / 0,13
					
FTLD-66ET 26060631	Fry-top elettrico liscio, piastra cm.55,5x55 - 2 zone di cottura EN Electric Fry-top smooth griddle, plate cm.55,5x55 - 2 cooking areas • DE Griddleplatte elektrische glatt, platte cm.55,5x55 - 2 Heizzonen • FR Plaque électriques lisse, plaque cm.55,5x55 - 2 zones de cuisson • ES FRY-TOP ELÉCTRICO LISO, PLANCHA CM.55,5X55 - 2 ZONAS DE COCCIÓN cm. 60x 60x 22h		⚡ 6 kW 400V~3N 230V~3 230V~ 50/60 Hz		1.871,00 45 / 0,22
					
FTLD-66ETS 26060634	Fry-top elettrico liscio cromato SUPERCHROME (Moca Approved), piastra cm.55,5x55 - 2 zone di cottura EN Electric Fry-top smooth chromed griddle SUPERCHROME (Moca Approved), plate cm.55,5x55 - 2 cooking areas • DE Griddleplatte elektrische glatt hartverchromt SUPERCHROME (Moca Approved), platte cm.55,5x55 - 2 Heizzonen • FR Plaque électriques lisse chromée SUPERCHROME (Moca Approved), plaque cm.55,5x55 - 2 zones de cuisson • ES FRY-TOP ELÉCTRICO LISO CROMADO SUPERCHROME (MOCA APPROVED), PLANCHA CM.55,5X55 - 2 ZONAS DE COCCIÓN cm. 60x 60x 22h		⚡ 6 kW 400V~3N 230V~3 230V~ 50/60 Hz		2.451,00 45 / 0,22
					
FTLRD-66ET 26060632	Fry-top elettrico 1/2 rigato + 1/2 liscio, piastra cm.55,5x55 - 2 zone di cottura EN Electric Fry-top 1/2 grooved + 1/2 smooth, plate cm.55,5x55 - 2 cooking areas • DE Griddleplatte elektrische 1/2 gerillt + 1/2 glatt, platte cm.55,5x55 - 2 Heizzonen • FR Plaque électriques 1/2 nervurée + 1/2 lisse, plaque cm.55,5x55 - 2 zones de cuisson • ES FRY-TOP ELÉCTRICO 1/2 ESTRIADO + 1/2 LISO, PLANCHA CM.55,5X55 - 2 ZONAS DE COCCIÓN cm. 60x 60x 22h		⚡ 6 kW 400V~3N 230V~3 230V~ 50/60 Hz		1.956,00 45 / 0,22
					

FRY-TOP ELETTRICI 60

MOD. _____
COD. _____

DESCRIZIONE/DESCRIPTION/BEZEICHNUNG/DESCRIPTION/DESCRIPCIÓN
DIMENSIONI/DIMENSIONS/ABMESSUNGEN/DIMENSIONS/DIMENSIONES

POTENZA/POWER/LEISTUNG/PUISSANCE/POTENCIA
VOLTAGGIO/VOLTAGE/SPANNUNG/VOLTAGE/VOLTAJE

⚡ kW _____
kcal/h _____
V~ _____
Hz _____

PREZZO/PRICE € _____
PREIS/PRIX/PRECIO _____
KG / M³ _____

FTLRD-66ETS Fry-top elettrico 1/2 rigato + 1/2 liscio cromato SUPERCHROME (Moca Approved), piastra cm.55,5x55 - 2 zone di cottura
EN Electric Fry-top 1/2 grooved + 1/2 smooth chromed griddle SUPERCHROME (Moca Approved), plate cm.55,5x55 - 2 cooking areas
• **DE** Griddleplatte elektrische 1/2 gerillt + 1/2 glatt hartverchromt SUPERCHROME (Moca Approved), platte cm.55,5x55 - 2 Heizzonen
• **FR** Plaque électriques 1/2 nervurée + 1/2 lisse chromée SUPERCHROME (Moca Approved), plaque cm.55,5x55 - 2 zones de cuisson • **ES FRY-TOP ELÉCTRICO 1/2 ESTRIADO + 1/2 LISO CROMADO SUPERCHROME (MOCA APPROVED), PLANCHA CM.55,5X55 - 2 ZONAS DE COCCIÓN**
cm. 60x 60x 22h



⚡ 6 kW _____ **2.537,00**
400V~3N _____ 45 / 0,22
230V~3 _____
230V~ _____
50/60 Hz _____



FTRD-66ET Fry-top elettrico rigato, piastra cm.55,5x55 - 2 zone di cottura
EN Electric Fry-top grooved griddle, plate cm.55,5x55 - 2 cooking areas
• **DE** Griddleplatte elektrische gerillt, platte cm.55,5x55 - 2 Heizzonen
• **FR** Plaque électriques nervurée, plaque cm.55,5x55 - 2 zones de cuisson • **ES FRY-TOP ELÉCTRICO ESTRIADO, PLANCHA CM.55,5X55 - 2 ZONAS DE COCCIÓN**
cm. 60x 60x 22h



⚡ 6 kW _____ **2.007,00**
400V~3N _____ 45 / 0,22
230V~3 _____
230V~ _____
50/60 Hz _____

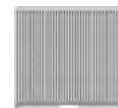

FTRD-66ETS Fry-top elettrico rigato cromato SUPERCHROME (Moca Approved), piastra cm.55,5x55 - 2 zone di cottura
EN Electric Fry-top grooved chromed griddle SUPERCHROME (Moca Approved), plate cm.55,5x55 - 2 cooking areas • **DE** Griddleplatte elektrische gerillt hartverchromt SUPERCHROME (Moca Approved), platte cm.55,5x55 - 2 Heizzonen • **FR** Plaque électriques nervurée chromée SUPERCHROME (Moca Approved), plaque cm.55,5x55 - 2 zones de cuisson • **ES FRY-TOP ELÉCTRICO ESTRIADO CROMADO SUPERCHROME (MOCA APPROVED), PLANCHA CM.55,5X55 - 2 ZONAS DE COCCIÓN**
cm. 60x 60x 22h



⚡ 6 kW _____ **2.586,00**
400V~3N _____ 45 / 0,22
230V~3 _____
230V~ _____
50/60 Hz _____



FTLD-68ET Fry-top elettrico liscio, piastra cm.75,5x55 - 2 zone di cottura
EN Electric Fry-top smooth griddle, plate cm.75,5x55 - 2 cooking areas
• **DE** Griddleplatte elektrische glatt, platte cm.75,5x55 - 2 Heizzonen
• **FR** Plaque électriques lisse, plaque cm.75,5x55 - 2 zones de cuisson • **ES FRY-TOP ELÉCTRICO LISO, PLANCHA CM.75,5X55 - 2 ZONAS DE COCCIÓN**
cm. 80x 60x 22h



⚡ 9 kW _____ **2.296,00**
400V~3N _____ 60 / 0,32
230V~3 _____
50/60 Hz _____



FTLD-68ETS Fry-top elettrico liscio cromato SUPERCHROME (Moca Approved), piastra cm.75,5x55 - 2 zone di cottura
EN Electric Fry-top smooth chromed griddle SUPERCHROME (Moca Approved), plate cm.75,5x55 - 2 cooking areas • **DE** Griddleplatte elektrische glatt hartverchromt SUPERCHROME (Moca Approved), platte cm.75,5x55 - 2 Heizzonen • **FR** Plaque électriques lisse chromée SUPERCHROME (Moca Approved), plaque cm.75,5x55 - 2 zones de cuisson • **ES FRY-TOP ELÉCTRICO LISO CROMADO SUPERCHROME (MOCA APPROVED), PLANCHA CM.75,5X55 - 2 ZONAS DE COCCIÓN**
cm. 80x 60x 22h



⚡ 9 kW _____ **3.109,00**
400V~3N _____ 60 / 0,32
230V~3 _____
50/60 Hz _____



FTLRD-68ET Fry-top elettrico 1/2 rigato + 1/2 liscio, piastra cm.75,5x55 - 2 zone di cottura
EN Electric Fry-top 1/2 grooved + 1/2 smooth, plate cm.75,5x55 - 2 cooking areas • **DE** Griddleplatte elektrische 1/2 gerillt + 1/2 glatt, platte cm.75,5x55 - 2 Heizzonen • **FR** Plaque électriques 1/2 nervurée + 1/2 lisse, plaque cm.75,5x55 - 2 zones de cuisson • **ES FRY-TOP ELÉCTRICO 1/2 ESTRIADO + 1/2 LISO, PLANCHA CM.75,5X55 - 2 ZONAS DE COCCIÓN**
cm. 80x 60x 22h



⚡ 9 kW _____ **2.378,00**
400V~3N _____ 60 / 0,32
230V~3 _____
50/60 Hz _____



FRY-TOP ELETTRICI 60

MOD. _____
COD. _____

DESCRIZIONE/DESCRIPTION/BEZEICHNUNG/DESCRIPTION/DESCRIPCIÓN
DIMENSIONI/DIMENSIONS/ABMESSUNGEN/DIMENSIONS/DIMENSIONES

POTENZA/POWER/LEISTUNG/PUISSANCE/POTENCIA
VOLTAGGIO/VOLTAGE/SPANUNNG/VOLTAGE/VOLTAJE

9 kW
kcal/h

400V~3N
V~
Hz

PREZZO/PRICE €
PREIS/PRIX/PRECIO
KG / M³

FTRD-68ETS Fry-top elettrico 1/2 rigato + 1/2 liscio cromato SUPERCHROME (Moca Approved), piastra cm.75,5x55 - 2 zone di cottura
EN Electric Fry-top 1/2 grooved + 1/2 smooth chromed griddle SUPERCHROME (Moca Approved), plate cm.75,5x55 - 2 cooking areas
• **DE** Griddleplatte elektrische 1/2 gerillt + 1/2 glatt hartverchromt SUPERCHROME (Moca Approved), platte cm.75,5x55 - 2 Heizzonen
• **FR** Plaque électriques 1/2 nervurée + 1/2 lisse chromée SUPERCHROME (Moca Approved), plaque cm.75,5x55 - 2 zones de cuisson • **ES FRY-TOP ELÉCTRICO 1/2 ESTRIADO + 1/2 LISO CROMADO SUPERCHROME (MOCA APPROVED), PLANCHA CM.75,5X55 - 2 ZONAS DE COCCIÓN**
cm. 80x 60x 22h



9 kW **3.279,00**
400V~3N 60 / 0,32
230V~3
50/60 Hz



FTRD-68ET Fry-top elettrico rigato, piastra cm.75,5x55 - 2 zone di cottura
EN Electric Fry-top grooved griddle, plate cm.55,5x55 - 2 cooking areas
• **DE** Griddleplatte elektrische gerillt, platte cm.55,5x55 - 2 Heizzonen
• **FR** Plaque électriques nervurée, plaque cm.55,5x55 - 2 zones de cuisson • **ES FRY-TOP ELÉCTRICO ESTRIADO, PLANCHA CM.55,5X55 - 2 ZONAS DE COCCIÓN**
cm. 80x 60x 22h



9 kW **2.432,00**
400V~3N 60 / 0,32
230V~3
50/60 Hz



FTRD-68ETS Fry-top elettrico rigato cromato SUPERCHROME (Moca Approved), piastra cm.75,5x55 - 2 zone di cottura
EN Electric Fry-top grooved chromed griddle SUPERCHROME (Moca Approved), plate cm.55,5x55 - 2 cooking areas • **DE** Griddleplatte elektrische gerillt hartverchromt SUPERCHROME (Moca Approved), platte cm.55,5x55 - 2 Heizzonen • **FR** Plaque électriques nervurée chromée SUPERCHROME (Moca Approved), plaque cm.55,5x55 - 2 zones de cuisson • **ES FRY-TOP ELÉCTRICO ESTRIADO CROMADO SUPERCHROME (MOCA APPROVED), PLANCHA CM.55,5X55 - 2 ZONAS DE COCCIÓN**
cm. 80x 60x 22h

9 kW **3.244,00**
400V~3N 60 / 0,32
230V~3
50/60 Hz



FTLD-84ET Fry-top elettrico liscio, piastra cm.36x68
EN Electric Fry-top smooth griddle, plate cm.36x68 • **DE** Griddleplatte elektrische glatt, platte cm.36x68 • **FR** Plaque électriques lisse, plaque cm.36x68 • **ES FRY-TOP ELÉCTRICO LISO, PLANCHA CM.36X68**
cm. 40x 80x 22h



7,5 kW **2.459,00**
400V~3N 45 / 0,23
50/60 Hz



FTLD-84ETS Fry-top elettrico liscio cromato SUPERCHROME (Moca Approved), piastra cm.36x68
EN Electric Fry-top smooth chromed griddle SUPERCHROME (Moca Approved), plate cm.36x68 • **DE** Griddleplatte elektrische glatt hartverchromt SUPERCHROME (Moca Approved), platte cm.36x68 • **FR** Plaque électriques lisse chromée SUPERCHROME (Moca Approved), plaque cm.36x68 • **ES FRY-TOP ELÉCTRICO LISO CROMADO SUPERCHROME (MOCA APPROVED), PLANCHA CM.36X68**
cm. 40x 80x 22h

7,5 kW **3.081,00**
400V~3N 45 / 0,23
50/60 Hz



FTLD-88ET Fry-top elettrico liscio, piastra cm.76x68 - 2 zone di cottura
EN Electric Fry-top smooth griddle, plate cm.76x68 - 2 cooking areas
• **DE** Griddleplatte elektrische glatt, platte cm.76x68 - 2 Heizzonen
• **FR** Plaque électriques lisse, plaque cm.76x68 - 2 zones de cuisson
• **ES FRY-TOP ELÉCTRICO LISO, PLANCHA CM.76X68 - 2 ZONAS DE COCCIÓN**
cm. 80x 80x 22h



15 kW **3.642,00**
400V~3N 90 / 0,44
50/60 Hz



FRY-TOP ELETTRICI 80

MOD. _____
COD. _____

DESCRIZIONE/DESCRIPTION/BEZEICHNUNG/DESCRIPTION/DESCRIPCIÓN
DIMENSIONI/DIMENSIONS/ABMESSUNGEN/DIMENSIONS/DIMENSIONES

POTENZA/POWER/LEISTUNG/PUISSANCE/POTENCIA
VOLTAGGIO/VOLTAGE/SPANNUNG/VOLTAGE/VOLTAJE

⚡ kW kcal/h
⚡ kw V~ Hz

PREZZO/PRICE €
PREIS/PRIX/PRECIO €
KG / M³

FTLD-88ETS Fry-top elettrico liscio cromato SUPERCHROME (Moca Approved), piastra cm.76x68 - 2 zone di cottura
28060834
EN Electric Fry-top smooth chromed griddle SUPERCHROME (Moca Approved), plate cm.76x68 - 2 cooking areas • **DE** Griddleplatte elektrische glatt hartverchromt SUPERCHROME (Moca Approved), platte cm.76x68 - 2 Heizzonen • **FR** Plaque électriques lisse chromée SUPERCHROME (Moca Approved), plaque cm.76x68 - 2 zones de cuisson • **ES FRY-TOP ELÉCTRICO LISO CROMADO SUPERCHROME (MOCA APPROVED), PLANCHA CM.76X68 - 2 ZONAS DE COCCIÓN**
cm. 80x 80x 22h



⚡ 15 kW 4.471,00
400V~3N 90 / 0,44
50/60 Hz



FTRLR-88ET Fry-top elettrico 1/2 rigato + 1/2 liscio, piastra cm.76x68 - 2 zone di cottura
28060832
EN Electric Fry-top 1/2 grooved + 1/2 smooth, plate cm.76x68 - 2 cooking areas • **DE** Griddleplatte elektrische 1/2 gerillt + 1/2 glatt, platte cm.76x68 - 2 Heizzonen • **FR** Plaque électriques 1/2 nervurée + 1/2 lisse, plaque cm.76x68 - 2 zones de cuisson • **ES FRY-TOP ELÉCTRICO 1/2 ESTRIADO + 1/2 LISO, PLANCHA CM.76X68 - 2 ZONAS DE COCCIÓN**
cm. 80x 80x 22h



⚡ 15 kW 3.824,00
400V~3N 90 / 0,44
50/60 Hz



FTRLR-88ETS Fry-top elettrico 1/2 rigato + 1/2 liscio cromato SUPERCHROME (Moca Approved), piastra cm.76x68 - 2 zone di cottura
28060835
EN Electric Fry-top 1/2 grooved + 1/2 smooth chromed griddle SUPERCHROME (Moca Approved), plate cm.76x68 - 2 cooking areas • **DE** Griddleplatte elektrische 1/2 gerillt + 1/2 glatt hartverchromt SUPERCHROME (Moca Approved), platte cm.76x68 - 2 Heizzonen • **FR** Plaque électriques 1/2 nervurée + 1/2 lisse chromée SUPERCHROME (Moca Approved), plaque cm.76x68 - 2 zones de cuisson • **ES FRY-TOP ELÉCTRICO 1/2 ESTRIADO + 1/2 LISO CROMADO SUPERCHROME (MOCA APPROVED), PLANCHA CM.76X68 - 2 ZONAS DE COCCIÓN**
cm. 80x 80x 22h



⚡ 15 kW 4.652,00
400V~3N 90 / 0,44
50/60 Hz



PCD-64ET PIANO COTTURA TRIFASE N. 2 piastre
26030430
EN Boiling unit - N. 2 plates • **DE** Kochplatte - N. 2 Kochplatten • **FR** Rechaud - N. 2 plaques • **ES SOBRE DE COCCIÓN - N. 2 PLANCHAS**
cm. 40x 60x 5h



⚡ 5,2 kW 772,00
400V~2N 19 / 0,13
230V~3
230V~
50/60 Hz

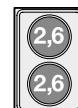

PCD-68ET PIANO COTTURA TRIFASE N. 4 piastre
26030830
EN Boiling unit - N. 4 plates • **DE** Kochplatte - N. 4 Kochplatten • **FR** Rechaud - N. 4 plaques • **ES SOBRE DE COCCIÓN - N. 4 PLANCHAS**
cm. 80x 60x 5h



⚡ 10,4 kW 1.191,00
400V~3N 38 / 0,32
230V~3
230V~
50/60 Hz



PCQD-64ET PIANO COTTURA TRIFASE - N. 2 piastre quadre
26030431
EN Boiling unit threephase - N. 2 square plates • **DE** Kochplatte dreiphasig - N. 2 quadratischen Platten • **FR** Rechaud électriques - N. 2 plaques carrés • **ES SOBRE DE COCCIÓN TRIFÁSICO - N. 2 PLANCHAS CUADRADAS**
cm. 40x 60x 5h



⚡ 5,2 kW 1.528,00
400V~2N 19 / 0,13
230V~3
230V~
50/60 Hz

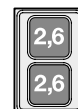

PIANI COTTURA ELETTRICI 60

MOD. _____
COD. _____

DESCRIZIONE/DESCRIPTION/BEZEICHNUNG/DESCRIPTION/DESCRIPCIÓN
DIMENSIONI/DIMENSIONS/ABMESSUNGEN/DIMENSIONES

POTENZA/POWER/LEISTUNG/PUISSANCE/POTENCIA
VOLTAGGIO/VOLTAGE/SPANNUNG/VOLTAGE/VOLTAGE

⚡ kW kcal/h
⚡ kW V~ Hz

PREZZO/PRICE €
PREIS/PRIX/PRECIO €
KG / M³

PCQD-68ET PIANO COTTURA TRIFASE - N. 4 piastre quadre
26030831 **EN** Boiling unit threephase - N. 4 square plates • **DE** Kochplatte dreiphasig - N. 4 quadratischen Platten • **FR** Rechaud électriques - N. 4 plaques carrés • **ES SOBRE DE COCCIÓN TRIFÁSICO - N. 4 PLANCHAS CUADRADAS**
cm. 80x 60x 5h



⚡ 10,4 kW **2.678,00**
400V~3N 38 / 0,32
230V~3
50/60 Hz



PCQD-84ET PIANO COTTURA TRIFASE - N. 2 piastre quadre
28030431 **EN** Boiling unit threephase - N. 2 square plates • **DE** Kochplatte dreiphasig - N. 2 quadratischen Platten • **FR** Rechaud électriques - N. 2 plaques carrés • **ES SOBRE DE COCCIÓN TRIFÁSICO - N. 2 PLANCHAS CUADRADAS**
cm. 40x 80x 5h



⚡ 8 kW **2.143,00**
400V~2N 24 / 0,23
230V~3
230V~
50/60 Hz



PCQD-88ET PIANO COTTURA TRIFASE - N. 4 piastre quadre
28030831 **EN** Boiling unit threephase - N. 4 square plates • **DE** Kochplatte dreiphasig - N. 4 quadratischen Platten • **FR** Rechaud électriques - N. 4 plaques carrés • **ES SOBRE DE COCCIÓN TRIFÁSICO - N. 4 PLANCHAS CUADRADAS**
cm. 80x 80x 5h

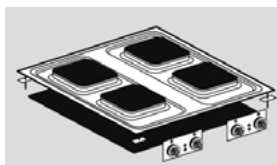

⚡ 16 kW **3.958,00**
400V~3N 48 / 0,44
50/60 Hz



PCCD-64ET PIANO COTTURA VETROCERAMICA TRIFASE - N. 2 zone - vetro
26030432 cm.35x57
EN Ceramic glass boiling unit - n. 2 zones - glass cm.35x57 • **DE** Ceran-Kochplatte dreiphasig - 2 zonen - Glas 35x57 cm • **FR** Plan de cuisson à vitroceramique triphasé N. 2 zones - Verre cm.35x57 • **ES SOBRE DE COCCIÓN TRIFÁSICO VITROCERÁMICA - 2 ZONAS - VIDRO CM.35X57**
cm. 40x 60x 5h



⚡ 5 kW **1.639,00**
400V~2N 12 / 0,13
230V~3
230V~
50/60 Hz

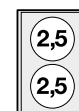

PCCD-68ET PIANO COTTURA VETROCERAMICA TRIFASE - N. 4 zone - vetro
26030832 cm.75x57
EN Ceramic glass boiling unit - n. 4 zones - glass cm.75x57 • **DE** Ceran-Kochplatte dreiphasig - 4 zonen - Glas 75x57 cm • **FR** Plan de cuisson à vitroceramique triphasé N. 4 zones - Verre cm.75x57 • **ES SOBRE DE COCCIÓN TRIFÁSICO VITROCERÁMICA - 4 ZONAS - VIDRO CM.75X57**
cm. 80x 60x 5h



⚡ 10 kW **2.446,00**
400V~3N 40 / 0,32
230V~3
50/60 Hz

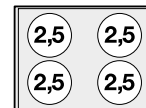

PIANI COTTURA ELETTRICI 80

MOD. _____
COD. _____

DESCRIZIONE/DESCRIPTION/BEZEICHNUNG/DESCRIPTION/DESCRIPCIÓN
DIMENSIONI/DIMENSIONS/ABMESSUNGEN/DIMENSIONS/DIMENSIONES

POTENZA/POWER/LEISTUNG/PUISSANCE/POTENCIA
VOLTAGGIO/VOLTAGE/SPANNUNG/VOLTAGE/VOLTAGE

⚡ kW _____
kcal/h _____
V~ _____
Hz _____

PREZZO/PRICE €
PREIS/PRIX/PRECIO €
KG / M³

PCCD-84ET
28030432

PIANO COTTURA VETROCERAMICA TRIFASE - N. 2 zone - vetro cm.35x77
EN Ceramic glass boiling unit - n. 2 zones - glass cm.35x77 • **DE** Ceran-Kochplatte dreiphasig - 2 zonen - Glas 35x77 cm • **FR** Plan de cuisson à vitrocéramique triphasé N. 2 zones - Verre cm.35x77
• **ES SOBRE DE COCCIÓN TRIFÁSICO VITROCERÁMICA - 2 ZONAS - VIDRO CM.35X77**
cm. 40x 80x 5h

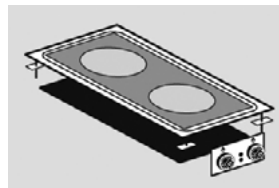

⚡ 6,8 kW _____ **2.683,00**
400V~2N _____ 24 / 0,23
230V~3 _____
230V~ _____
50/60 Hz _____



PCCD-88ET
28030832

PIANO COTTURA VETROCERAMICA TRIFASE - N. 4 zone - vetro cm.75x77
EN Ceramic glass boiling unit - n. 4 zones - glass cm.75x77 • **DE** Ceran-Kochplatte dreiphasig - 4 zonen - Glas 75x77 cm • **FR** Plan de cuisson à vitrocéramique triphasé N. 4 zones - Verre cm.75x77
• **ES SOBRE DE COCCIÓN TRIFÁSICO VITROCERÁMICA - 4 ZONAS - VIDRO CM.75X77**
cm. 80x 80x 5h



⚡ 13,6 kW _____ **4.699,00**
400V~3N _____ 48 / 0,44
230V~3 _____
50/60 Hz _____

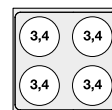

PCID-44ET
24030433

PIANO COTTURA INDUZIONE TRIFASE - N. 1 zona - Vetro cm.35x35 (non posizionare su forni o cassettiere)
EN Three-phase induction cooking - 1 zone - glass cm.35x35 (do not place on ovens or drawers) • **DE** Induktions-Kochplatte dreiphasig - 1 zone - Glas 35x35 cm (nicht Platz auf Öfen oder Schubladen) • **FR** Plan de cuisson à induction triphasé N. 1 zone - Verre cm.35x35 (ne placez pas sur des fours ou des tiroirs) • **ES ENCIMERA INDUCCIÓN TRIFÁSICA - 1 ZONA - VIDRIO CM.35X35 (NO COLOQUE EN LOS HORNOS O EN LOS CAJONES)**
cm. 40x 40x 31h



⚡ 5 kW _____ **5.372,00**
400V~3 _____ 18 / 0,17
50/60 Hz _____

PCID-64ET
26030433

PIANO COTTURA INDUZIONE TRIFASE - N. 2 zone - Vetro cm.35x57 (non posizionare su forni o cassettiere)
EN Three-phase induction cooking - 2 zones - glass cm.35x57 (do not place on ovens or drawers) • **DE** Induktions-Kochplatte dreiphasig - 2 zonen - Glas 35x57 cm (nicht Platz auf Öfen oder Schubladen) • **FR** Plan de cuisson à induction triphasé N. 2 zones - Verre cm.35x57 (ne placez pas sur des fours ou des tiroirs) • **ES ENCIMERA INDUCCIÓN TRIFÁSICA - 2 ZONAS - VIDRIO CM.35X57 (NO COLOQUE EN LOS HORNOS O EN LOS CAJONES)**
cm. 40x 60x 31h



⚡ 10 kW _____ **8.357,00**
400V~3 _____ 20 / 0,17
50/60 Hz _____

PIANI COTTURA A INDUZIONE 80

MOD. _____
COD. _____

DESCRIZIONE/DESCRIPTION/BEZEICHNUNG/DESCRIPTION/DESCRIPCIÓN
DIMENSIONI/DIMENSIONS/ABMESSUNGEN/DIMENSIONS/DIMENSIONES

POTENZA/POWER/LEISTUNG/PUISSANCE/POTENCIA
VOLTAGGIO/VOLTAGE/SPANNUNG/VOLTAGE/VOLTAJE

⚡ kW _____
kcal/h _____

⚡ kW _____
V~ _____
Hz _____

PREZZO/PRICE € _____
PREIS/PRIX/PRECIO € _____
KG / M³ _____

PCID-84ET
28030433

PIANO COTTURA INDUZIONE TRIFASE - N. 2 zone - Vetro cm.35x77
(non posizionare su forni o cassettiere)

EN Three-phase induction cooking - 2 zones - glass cm.35x77 (do not place on ovens or drawers) • **DE** Induktions-Kochplatte dreiphasig - 2 zonen - Glas 35x77 cm (nicht Platz auf Öfen oder Schubladen) • **FR** Plan de cuisson à induction triphasé N. 2 zones - Verre cm.35x77 (ne placez pas sur des fours ou des tiroirs) • **ES ENCIMERA INDUCCIÓN TRIFÁSICA - 2 ZONAS - VIDRIO CM.35X77 (NO COLOQUE EN LOS HORNOS O EN LOS CAJONES)**
cm. 40x 80x 31h



⚡ 10 kW _____ **8.619,00**
400V~3 _____ 25 / 0,23
50/60 Hz

PCID-68ET
26030833

PIANO COTTURA INDUZIONE TRIFASE - N. 4 zone - Vetro cm.75x57
(non posizionare su forni o cassettiere)

EN Three-phase induction cooking - 4 zones - glass cm.75x57 (do not place on ovens or drawers) • **DE** Induktions-Kochplatte dreiphasig - 4 zonen - Glas 75x57 cm (nicht Platz auf Öfen oder Schubladen) • **FR** Plan de cuisson à induction triphasé N. 4 zones - Verre cm.75x57 (ne placez pas sur des fours ou des tiroirs) • **ES ENCIMERA INDUCCIÓN TRIFÁSICA - 4 ZONAS - VIDRIO CM.75X57 (NO COLOQUE EN LOS HORNOS O EN LOS CAJONES)**
cm. 80x 60x 31h

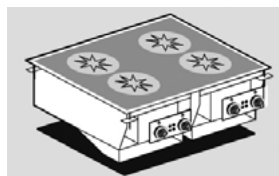

⚡ 20 kW _____ **15.651,00**
400V~3 _____ 40 / 0,32
50/60 Hz

PCID-88ET
28030833

PIANO COTTURA INDUZIONE TRIFASE - N. 4 zone - Vetro cm.75x77
(non posizionare su forni o cassettiere)

EN Three-phase induction cooking - 4 zones - glass cm.75x77 (do not place on ovens or drawers) • **DE** Induktions-Kochplatte dreiphasig - 4 zonen - Glas 75x77 cm (nicht Platz auf Öfen oder Schubladen) • **FR** Plan de cuisson à induction triphasé N. 4 zones - Verre cm.75x77 (ne placez pas sur des fours ou des tiroirs) • **ES ENCIMERA INDUCCIÓN TRIFÁSICA - 4 ZONAS - VIDRIO CM.75X77 (NO COLOQUE EN LOS HORNOS O EN LOS CAJONES)**
cm. 80x 80x 31h



⚡ 20 kW _____ **16.546,00**
400V~3 _____ 50 / 0,44
50/60 Hz

PIANI COTTURA A INDUZIONE 60

MOD. _____
COD. _____

DESCRIZIONE/DESCRIPTION/BEZEICHNUNG/DESCRIPTION/DESCRIPCIÓN
DIMENSIONI/DIMENSIONS/ABMESSUNGEN/DIMENSIONS/DIMENSIONES

POTENZA/POWER/LEISTUNG/PUISSANCE/POTENCIA
VOLTAGGIO/VOLTAGE/SPANNUNG/VOLTAGE/VOLTAGE

⚡ kW _____
kcal/h _____
V~ _____
Hz _____

PREZZO/PRICE €
PREIS/PRIX/PRECIO €
KG / M³

PCIWD-64ET PIANO COTTURA INDUZIONE TRIFASE "WOK" - N. 1 zona - Vetro Ø 30 cm. (non posizionare su forni o cassettiere)
26030434 **EN** Three-phase induction cooking "WOK" - 1 zone - glass Ø 30 cm (do not place on ovens or drawers) • **DE** Induktions-Kochplatte "WOK" dreiphasig - 1 zonen - Glas Ø 30 cm (nicht Platz auf Öfen oder Schubladen) • **FR** Plan de cuisson à induction "WOK" triphasé N. 1 zone - Verre cm Ø 30 (ne placez pas sur des fours ou des tiroirs) • **ES ENCIMERA INDUCCIÓN "WOK" TRIFÁSICA - 1 ZONA - VIDRIO Ø 30 CM (NO COLOQUE EN LOS HORNOS O EN LOS CAJONES)**
cm. 40x 60x 31h

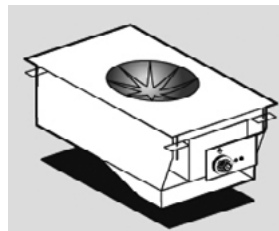

⚡ 5 kW _____ **6.285,00**
400V~3 _____ 20 / 0,17
50/60 Hz _____

TPD-68ET TUTTA PIASTRA Piastra cm. 70x50 - 4 zone
26120830 **EN** Solid top - Plate cm. 70x50- 4 zones • **DE** Kochplatten - Platte cm. 70x50 - 4 zonen • **FR** Toute plaque - Plaque cm. 70x50 - 4 zones • **ES PLACA DE COCCIÓN - PLACA CM. 70X50 - 4 ZONAS**
cm. 80x 60x 24h



⚡ 10 kW _____ **3.475,00**
400V~3N _____ 80 / 0,32
50/60 Hz _____

TPD-84ET TUTTA PIASTRA Piastra cm. 30x68 - 2 zone
28120430 **EN** Solid top - Plate cm. 30x68- 2 zones • **DE** Kochplatten - Platte cm. 30x68 - 2 zonen • **FR** Toute plaque - Plaque cm. 30x68 - 2 zones • **ES PLACA DE COCCIÓN - PLACA CM. 30X68 - 2 ZONAS**
cm. 40x 80x 24h



⚡ 5 kW _____ **2.415,00**
400V~3N _____ 50 / 0,23
50/60 Hz _____

TPD-88ET TUTTA PIASTRA Piastra cm. 70x68 - 4 zone
28120830 **EN** Solid top - Plate cm. 70x68- 4 zones • **DE** Kochplatten - Platte cm. 70x68 - 4 zonen • **FR** Toute plaque - Plaque cm. 70x68 - 4 zones • **ES PLACA DE COCCIÓN - PLACA CM. 70X68 - 4 ZONAS**
cm. 80x 80x 24h



⚡ 13,6 kW _____ **4.333,00**
400V~3N _____ 93 / 0,44
50/60 Hz _____

FSD-78ET Forno elettrico statico cm. 67x55x34h, temp: 50÷300°C, con 1 griglia cm.65x53 GN2/1
26500830 **EN** Traditional electric oven cm. 67x55x34h, temp: 50÷300°C, with 1 grid cm.65x53 GN2/1 • **DE** Statischer Elektro-Backofen cm. 67x55x34h, temp: 50÷300°C, mit 1 Rost cm.65x53 GN2/1 • **FR** Four électrique statique cm. 67x55x34h, temp: 50÷300°C, avec 1 grille cm.65x53 GN2/1 • **ES HORNO ELÉCTRICO ESTÁTICO CM. 67X55X34H, TEMP: 50÷300 °C, CON 1 PARILLA CM.65X53 GN2/1**
cm. 80x 69x 48,6h



⚡ 5 kW _____ **1.906,00**
400V~3N _____ 40 / 0,49
50/60 Hz _____

FVD-78ET Forno elettrico ventilato cm. 55x36x34h, temp: 50÷300°C, con 1 griglia cm.53x32,5 GN1/1
26500835 **EN** Electric fan oven cm. 55x36x34h, temp: 50÷300°C, with 1 grid cm.53x32,5 GN1/1 • **DE** Elektro-Heißluftofen cm. 55x36x34h, temp: 50÷300°C, mit 1 Rost cm.53x32,5 GN1/1 • **FR** Four à chaleur tournante électrique cm. 55x36x34h, temp: 50÷300°C, avec 1 grille cm.53x32,5 GN1/1 • **ES HORNO ELÉCTRICO VENTILADO CM. 55X36X34H, TEMP: 50÷300 °C, CON 1 PARILLA CM.53X32,5 GN1/1**
cm. 80x 61,5x 48,6h

⚡ 5,32 kW _____ **2.348,00**
400V~3N _____ 40 / 0,49
230V~3 _____
50/60 Hz _____

FORNI ELETTRICI 90

MOD. COD.	DESCRIZIONE/DESCRIPTION/BEZEICHNUNG/DESCRIPTION/DESCRIPCIÓN DIMENSIONI/DIMENSIONS/ABMESSUNGEN/DIMENSIONS/DIMENSIONES	POTENZA/POWER/LEISTUNG/PUISSANCE/POTENCIA VOLTAGGIO/VOLTAGE/SPANNUNG/VOLTAGE/VOLTAJE	$\frac{\text{kW}}{\text{kcal/h}}$ $\frac{\text{kW}}{\text{V~}} \frac{\text{Hz}}$	PREZZO/PRICE € PREIS/PRIX/PRECIO KG / M ³
---------------------	---	---	--	---

FSD-98ET
28500830

Forno elettrico statico cm. 67x73x34h, temp: 50÷300°C, con 1 griglia cm.65x71 GN2/1
EN Traditional electric oven cm. 67x73x34h, temp: 50÷300°C, with 1 grid cm.65x71 GN2/1 • **DE** Statischer Elektro-Backofen cm. 67x73x34h, temp: 50÷300°C, mit 1 Rost cm.65x71 GN2/1 • **FR** Four électrique statique cm. 67x73x34h, temp: 50÷300°C, avec 1 grille cm.65x71 GN2/1 • **ES HORNO ELÉCTRICO ESTÁTICO CM. 67X73X34H, TEMP: 50÷300 °C, CON 1 PARILLA CM.65X71 GN2/1**
cm. 80x 85,5x 48,6h



$\frac{6,7 \text{ kW}}{400\text{V}\sim 3\text{N}} \frac{2.007,00}{50/60 \text{ Hz}} \frac{45}{0,62}$

CSD012E
_CSD012E

Forno per cottura a basse temperature a 2 cassetti GN1/1 max cm.15h. Temp: 30÷120°C. Pannello di controllo con regolazione elettronica del tempo, della temperatura e della sonda al cuore, funzione mantenimento. VERSIONE INCASSO PER FREEBLOCK 5_0
EN Low temperature oven with 2 drawers GN1/1 max. cm.15h, temp: 30÷120°C. Electronic control of the time, temperature and core probe, HOLD function. DROPIN VERSION FOR FREEBLOCK 5_0. • **DE** Niedertemperaturofen mit 2 SchubladenGN1/1 max. cm.15h, temp: 30÷120°C. Bedienfeld mit elektronischer Einstellung für Zeit, Temperatur, heißer Wartungsfunktion. DROPIN VERSION FÜR FREEBLOCK 5_0. • **FR** Four basse température avec 2 tiroirs GN1/1 max. cm.15h, temp: 30÷120°C. Contrôle électronique du temps, température et sonde à cœur, fonction de maintenance à chaud. DROPIN VERSION POUR FREEBLOCK 5_0. • **ES HORNO DE BAJA TEMPERATURA CON 2 CAJONES GN1/1 MAX. CM.15H, TEMP: 30÷120 °C. PANEL DE CONTROL CON REGULACIÓN ELECTRÓNICA DE TIEMPO, TEMPERATURA Y SONDA AL CORAZÓN, FUNCIÓN DE MANTENIMIENTO CALIENTE. VERSION DE ENCASTRE PARA FREEBLOCK 5_0.**
cm. 80x 61x 51h



$\frac{1 \text{ kW}}{230\text{V}\sim} \frac{4.396,00}{50 \text{ Hz}} \frac{55}{0,44}$

PCD-44G
24210450

PIANO COTTURA 1 fuoco
EN Boiling unit - 1 burner • **DE** kochplatte - 1 Kochstellen • **FR** Rechaud - 1 feux vifs • **ES SOBRE DE COCCIÓN - 1 QUEMADOR**
cm. 40x 40x 14h



$\frac{10 \text{ kW}}{8.600 \text{ kcal/h}} \frac{1.231,00}{23 / 0,17}$

PCD-55G
25210550

PIANO COTTURA 1 fuoco, con griglia ribassata per allineamento ai modelli gas TPD/FTD
EN Boiling unit - 1 burner, with lowered grid for alignment to gas models TPD/FTD • **DE** kochplatte - 1 Kochstellen, mit abgesenktem Gitter zur Ausrichtung mit den Gasmodellen TPD/FTD • **FR** Rechaud - 1 feux vifs, avec grille abaissée pour l'alignement sur les modèles à gaz TPD/FTD • **ES SOBRE DE COCCIÓN - 1 QUEMADOR, CON REJILLA REBAJADA PARA SU ALINEACIÓN CON LOS MODELOS DE GAS TPD/FTD**
cm. 50x 50x 22h



$\frac{10 \text{ kW}}{8.600 \text{ kcal/h}} \frac{1.301,00}{24 / 0,27}$

PCD-64G
26210450

PIANO COTTURA 2 fuochi
EN Gas heated boiling - 2 burners • **DE** Gas-Kochplatte - 2 Kochstellen • **FR** Rechaud gaz - 2 feux vifs • **ES SOBRES DE COCCIÓN GAS - 2 QUEMADORES**
cm. 40x 60x 11h



$\frac{13 \text{ kW}}{11.180 \text{ kcal/h}} \frac{1.409,00}{20 / 0,17}$

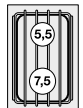

PCD-68G
26210850

PIANO COTTURA 4 fuochi
EN Gas heated boiling unit - 4 burners • **DE** Gas-Kochplatte - 4 Kochstellen • **FR** Rechaud gaz - 4 feux vifs • **ES SOBRES DE COCCIÓN GAS - 4 QUEMADORES**
cm. 80x 60x 11h



$\frac{22 \text{ kW}}{18.920 \text{ kcal/h}} \frac{2.652,00}{40 / 0,35}$

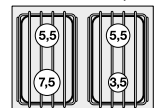

PIANI COTTURA A GAS 80

MOD. _____
COD. _____

DESCRIZIONE/DESCRIPTION/BEZEICHNUNG/DESCRIPTION/DESCRIPCIÓN
DIMENSIONI/DIMENSIONS/ABMESSUNGEN/DIMENSIONS/DIMENSIONES

POTENZA/POWER/LEISTUNG/PUISSANCE/POTENCIA
VOLTAGGIO/VOLTAGE/SPANNUNG/VOLTAGE/VOLTAJE

⚡ kW kcal/h
⚡ kw kcal/h
V~ Hz

PREZZO/PRICE €
PREIS/PRIX/PRECIO €
KG / M³

PCD-84G
28210450
PIANO COTTURA 2 fuochi
EN Gas heated boiling unit - 2 burners • **DE** Gas-Kochplatte - 2 Kochstellen
• **FR** Rechaud gaz - 2 feux vifs • **ES SOBRES DE COCCIÓN GAS - 2 QUEMADORES**
cm. 40x 80x 11h



⚡ 11 kW
9.460 kcal/h
1.854,00
55 / 0,23



PCD-88G
28210850
PIANO COTTURA 4 fuochi
EN Gas heated boiling unit - 4 burners • **DE** Gas-Kochplatte - 4 Kochstellen • **FR** Rechaud gaz - 4 feux vifs • **ES SOBRES DE COCCIÓN GAS - 4 QUEMADORES**
cm. 80x 80x 11h



⚡ 28 kW
24.080 kcal/h
3.248,00
75 / 0,44

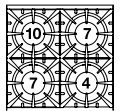

PCAD-84G
28310450
PIANO COTTURA ACQUA 2 fuochi - Rubinetto carico acqua, sfioratore
EN water heated boiling unit 2 burners - Water loading tap + overflow device • **DE** wasser-Kochplatte - 2 Kochstellen - Wasserlauf-Hahn + Überlauf-Vorrichtung • **FR** Rechaud l'eau 2 feux vifs - Robinet d'arrivée d'eau trop plein • **ES SOBRES DE COCCIÓN AGUA 2 QUEMADORES - GRIFO CARGA AGUA + VERTEDERO**
cm. 40x 80x 12h



⚡ 14 kW
12.040 kcal/h
2.366,00
55 / 0,23

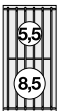

PCAD-88G
28310850
PIANO COTTURA ACQUA 4 fuochi - Rubinetto carico acqua, sfioratore
EN water heated boiling unit 4 burners - Water loading tap + overflow device • **DE** wasser-kochplatte - 4 Kochstellen - Wasserlauf-Hahn + Überlauf-Vorrichtung • **FR** Rechaud l'eau 4 feux vifs - Robinet d'arrivée d'eau trop plein • **ES SOBRES DE COCCIÓN AGUA 4 QUEMADORES - GRIFO CARGA AGUA + VERTEDERO**
cm. 80x 80x 12h



⚡ 28 kW
24.080 kcal/h
3.911,00
75 / 0,44



CPD-74G
27270450
CUOCIPASTA GAS LT 25 Vasca cm. 30,5x33,5x32,7h. Rubinetto carico acqua, sfioratore + scarico a pavimento. Accensione elettrica, indicatore presenza fiamma pilota. (CESTI ESCLUSI)
EN Gas pasta cooker 25 lts. Tank cm. 30,5x33,5x32,7h. Water loading cock + overflow device and floor draining. Electric ignition, flame presence indicator. (BASKETS EXCLUDED) • **DE** Gas-Nudelkocher lt. 25. Becken cm. 30,5x33,5x32,7h. Wasserlauf-Hahn, + Überlauf-Vorrichtung und Ablauf am Boden. Elektrische Zündung, Flammenpräsenzanzeige. (KORB AUSGESCHLOSSEN) • **FR** Cuiseur à pâtes gaz lt. 25. Cuve cm.30,5x33,5x32,7h. Robinet d'arrivée d'eau trop plein + système de vidange au sol. Allumage électrique, indicateur de présence de flamme. (PANIERS EXCLUS) • **ES CUECE PASTA GAS 25 LT. CUBA CM. 30,5X33,5X32,7H. GRIFO CARGA AGUA + VERTEDERO + DESCARGA A PAVIMENTO. IGNICIÓN ELÉCTRICA, INDICADOR EXTERNO DE LLAMA PILOTO. (CESTAS EXCLUIDAS)**
cm. 40x 70x 65h



⚡ 9,5 kW
8.160 kcal/h
3.091,00
51 / 0,37

⚡ 0,02 KW
230V~
50/60 Hz

COMBINAZIONI

- Combinations / • Zusammenstellungen
- Combinaisons / • Combinación múltiple



CUOCIPASTA GAS 70

MOD. _____
COD. _____

DESCRIZIONE/DESCRIPTION/BEZEICHNUNG/DESCRIPTION/DESCRIPCIÓN
DIMENSIONI/DIMENSIONS/ABMESSUNGEN/DIMENSIONS/DIMENSIONES

POTENZA/POWER/LEISTUNG/PUISSANCE/POTENCIA
VOLTAGGIO/VOLTAGE/SPANNUNG/VOLTAGE/VOLTAJE

⚡ kW kcal/h
⚡ kW V~ Hz

PREZZO/PRICE €
PREIS/PRIX/PRECIO €
KG / M³

CPAD-74G
27270455

CUOCIPASTA GAS LT 25 Vasca cm. 30,5x33,5x32,7h. Carico acqua automatico con sensore di livello - sfiatore + scarico a pavimento. Accensione elettrica, indicatore presenza fiamma pilota. (CESTI ESCLUSI)
EN Gas pasta cooker 25 lts. Tank cm. 30,5x33,5x32,7h. Automatic Water loading with level sensor - overflow device and floor draining. Electric ignition, flame presence indicator. (BASKETS EXCLUDED) • **DE** Gas-Nudelkocher lt. 25. Becken cm. 30,5x33,5x32,7h. Automatische Wasser Beladung mit Niveauregulierung + Überlauf-Vorrichtung und Ablauf am Boden. Elektrische Zündung, Flammenpräsenzanzeige. (KORB AUSGESCHLOSSEN) • **FR** Cuiseur à pâtes gaz lt. 25. Cuve cm.30,5x33,5x32,7h. Chargement automatique de l'eau avec sensor de niveau, trop plein Système de vidange au sol. Allumage électrique, indicateur de présence de flamme. (PANIERS EXCLUS) • **ES CUECE PASTA GAS 25 LT. CUBA CM. 30,5X33,5X32,7H. CARGA AUTOMÁTICA DE AGUA CON SENSOR DE NIVEL + VERTEDERO + DESCARGA A PAVIMENTO. IGNICIÓN ELÉCTRICA, INDICADOR EXTERNO DE LLAMA PILOTO. (CESTAS EXCLUIDAS)**
cm. 40x 70x 65h



⚡ 9,5 kW 3.371,00
8.160 kcal/h 51 / 0,37
⚡ 0,035 KW
230V~
50/60 Hz

COMBINAZIONI

- Combinations / • Zusammenstellungen
- Combinaisons / • Combinación múltiple



CPD-94G
29270450

CUOCIPASTA GAS LT. 40 Vasca cm. 30,7x50,9x32,7h. Rubinetto carico acqua, sfiatore + scarico a pavimento. Accensione elettrica, indicatore presenza fiamma pilota. (CESTI ESCLUSI)
EN Gas pasta cooker 40 lts. - Tank cm. 30,7x50,9x32,7h. Water loading tap + overflow device and floor draining. Electric ignition, flame presence indicator. (BASKETS EXCLUDED) • **DE** Gas-Nudelkocher lt. 40 - Becken cm. 30,7x50,9x32,7h. Wasserlauf-Hahn + Überlauf-Vorrichtung und Ablauf am Boden. Elektrische Zündung, Flammenpräsenzanzeige. (KORB AUSGESCHLOSSEN) • **FR** Cuiseur a pâtes gaz lt. 40 - Cuve cm.30,7x50,9x32,7h. Robinet d'arrivée d'eau trop plein Système de vidange au sol. Allumage électrique, indicateur de présence de flamme. (PANIERS EXCLUS) • **ES CUECE PASTA GAS 40 LT. - CUBA CM. 30,7X50,9X32,7H. GRIFO CARGA AGUA + VERTEDERO + DESCARGA A PAVIMENTO. IGNICIÓN ELÉCTRICA, INDICADOR EXTERNO DE LLAMA PILOTO. (CESTAS EXCLUIDAS)**
cm. 40x 90x 65h



⚡ 13,95 kW 3.305,00
11.997 kcal/h 58 / 0,46
⚡ 0,02 KW
230V~
50/60 Hz

COMBINAZIONI

- Combinations / • Zusammenstellungen
- Combinaisons / • Combinación múltiple



CUOCIPASTA GAS 90

MOD. _____
COD. _____

DESCRIZIONE/DESCRIPTION/BEZEICHNUNG/DESCRIPTION/DESCRIPCIÓN
DIMENSIONI/DIMENSIONS/ABMESSUNGEN/DIMENSIONS/DIMENSIONES

POTENZA/POWER/LEISTUNG/PUISSANCE/POTENCIA
VOLTAGGIO/VOLTAGE/SPANNUNG/VOLTAGE/VOLTAJE

⚡ kW
kcal/h

⚡ kw
V~
Hz

PREZZO/PRICE
PREIS/PRIX/PRECIO €
KG / M³

CPAD-94G
29270455

CUOCIPASTA GAS LT. 40 Vasca cm. 30,7x50,9x32,7h. Carico acqua automatico con sensore di livello - sfioratore + scarico a pavimento. Accensione elettrica, indicatore presenza fiamma pilota. (CESTI ESCLUSI)
EN Gas pasta cooker 40 lts. - Tank cm. 30,7x50,9x32,7h. Automatic Water loading with level sensor - overflow device and floor draining. Electric ignition, flame presence indicator. (BASKETS EXCLUDED) • **DE** Gas-Nudelkocher lt. 40 - Becken cm. 30,7x50,9x32,7h. Automatische Wasser Beladung mit Niveauregulierung + Überlauf-Vorrichtung und Ablauf am Boden. Elektrische Zündung, Flammenpräsenzanzeige. (KORB AUSGESCHLOSSEN) • **FR** Cuiseur a pates gaz lt. 40 - Cuve cm.30,7x50,9x32,7h. Chargement automatique de l'eau avec sensor de niveau, trop plein Système de vidange au sol. Allumage électrique, indicateur de présence de flamme. (PANIERES EXCLUS) • **ES CUECE PASTA GAS 40 LT. - CUBA CM. 30,7X50,9X32,7H. CARGA AUTOMÁTICA DE AGUA CON SENSOR DE NIVEL + VERTEDERO + DESCARGA A PAVIMENTO. IGNICIÓN ELÉCTRICA, INDICADOR EXTERNO DE LLAMA PILOTO. (CESTAS EXCLUIDAS)**
cm. 40x 90x 65h



⚡ 13,95 kW
11.997 kcal/h

3.586,00
58 / 0,46

⚡ 0,035 KW
230V~
50/60 Hz

COMBINAZIONI

- Combinations / • Zusammenstellungen
- Combinaisons / • Combinación múltiple

1/1	1/2	1/3	1/3	1/6/1/6	1/6/1/6
	1/2	1/3	2/3	1/3	1/6/1/6
		1/3		1/3	1/6/1/6

CWD-75G
27250550

GRIGLIA GAS-PIETRALAVICA, Griglia in acciaio inox cm. 38x52 regolabile. Accensione elettrica, indicatore presenza fiamma pilota, canale perimetrale allagabile, scarico con filtro removibile.
EN Charcoal grill gas, Stainless steel grill cm. 38x52. Electric ignition, flame presence indicator, floodable perimeter channel, drain with removable filter. • **DE** Gas-Lavasteingrill, Einstellbarer Rost aus Nirosta cm. 38x52. Elektrische Zündung, Flammenpräsenzanzeige, flutbaren Umfangskanal, Auspuff mit abnehmbarem Filter. • **FR** Grille à gaz en pierre de lave, Grille inox cm 38x52. Allumage électrique, indicateur de présence de flamme, un conduit extérieur inondable, échappement avec filtre amovible. • **ES PARRILLA A GAS PIEDRA LÁVICA, PARRILLA DE ACERO INOX REGULABLE CM 38X52. IGNICIÓN ELÉCTRICA, INDICADOR EXTERNO DE LLAMA PILOTO, CANAL PERIMETRAL INUNDABLE, DRENAJE CON FILTRO EXTRAÍBLE.**
cm. 50x 70x 33h



⚡ 9 kW
7.740 kcal/h

2.397,00
51 / 0,26

⚡ 0,01 KW
230V~
50/60 Hz

CWD-79G
27250950

GRIGLIA GAS-PIETRALAVICA, N. 2 griglie in acciaio inox cm. 38x52 regolabili, 2 zone di cottura. Accensione elettrica, indicatore presenza fiamma pilota, canale perimetrale allagabile, scarico con filtro removibile.
EN Charcoal grill gas, N. 2 Stainless steel grill cm. 38x52. 2 cooking areas. Electric ignition, flame presence indicator, floodable perimeter channel, drain with removable filter. • **DE** Gas-Lavasteingrill, N. 2 einstellbare Roste aus Nirosta cm. 38x52 - 2 Heizzonen. Elektrische Zündung, Flammenpräsenzanzeige, flutbaren Umfangskanal, Auspuff mit abnehmbarem Filter. • **FR** Grille a gaz en pierre de lave, N. 2 grilles réglables en acier inox cm. 38x52. 2 zones de cuisson. Allumage électrique, indicateur de présence de flamme, un conduit extérieur inondable, échappement avec filtre amovible. • **ES PARRILLA A GAS PIEDRA LÁVICA, N. 2 PARRILLAS DE ACERO INOX REGULABLE CM 38X52 2 ZONAS DE COCCIÓN. IGNICIÓN ELÉCTRICA, INDICADOR EXTERNO DE LLAMA PILOTO, CANAL PERIMETRAL INUNDABLE, DRENAJE CON FILTRO EXTRAÍBLE.**
cm. 90x 70x 33h



⚡ 18 kW
15.480 kcal/h

3.538,00
94 / 0,44

⚡ 0,01 KW
230V~
50/60 Hz

TUTTAPIASTRA GAS 70

MOD. COD.	DESCRIZIONE/DESCRIPTION/BEZEICHNUNG/DESCRIPTION/DESCRIPCIÓN DIMENSIONI/DIMENSIONS/ABMESSUNGEN/DIMENSIONS/DIMENSIONES	POTENZA/POWER/LEISTUNG/PUISSANCE/POTENCIA VOLTAGGIO/VOLTAGE/SPANNUNG/VOLTAGE/VOLTAJE	⚡ kW kcal/h	⚡ kW V~ Hz	PREZZO/PRICE € PREIS/PRIX/PRECIO € KG / M³
TPD-85G 28290550	<p>TUTTA PIASTRA GAS Piastra cm 37x57. Accensione elettrica, indicatore presenza fiamma pilota, canale perimetrale allagabile, scarico con filtro removibile.</p> <p>EN Solid top gas - Plate.37x57cm. Electric ignition, flame presence indicator, floodable perimeter channel, drain with removable filter.</p> <p>• DE Gas-Kochplatte - Platte.37x57 cm. Elektrische Zündung, Flammenpräsenzanzeige, flutbaren Umfangskanal, Auspuff mit abnehmbarem Filter. • FR Toute plaque à gaz - Plaque cm.37x57. Allumage électrique, indicateur de présence de flamme, un conduit extérieur inondable, échappement avec filtre amovible. • ES PLACA DE COCCIÓN A GAS - PLACA CM.37X57. IGNICIÓN ELÉCTRICA, INDICADOR EXTERNO DE LLAMA PILOTO, CANAL PERIMETRAL INUNDABLE, DRENAJE CON FILTRO EXTRAÍBLE.</p> <p>cm. 50x 80x 31h</p>		7 kW 6.020 kcal/h	0,01 KW 230V~ 50/60 Hz	3.450,00 58 / 0,33
TPD-89G 28290950	<p>TUTTA PIASTRA GAS Piastra cm 77x57. Accensione elettrica, indicatore presenza fiamma pilota, canale perimetrale allagabile, scarico con filtro removibile.</p> <p>EN Solid top gas - Plate.77x57cm. Electric ignition, flame presence indicator, floodable perimeter channel, drain with removable filter.</p> <p>• DE Gas-Kochplatte - Platte.77x57 cm. Elektrische Zündung, Flammenpräsenzanzeige, flutbaren Umfangskanal, Auspuff mit abnehmbarem Filter. • FR Toute plaque à gaz - Plaque cm.77x57. Allumage électrique, indicateur de présence de flamme, un conduit extérieur inondable, échappement avec filtre amovible. • ES PLACA DE COCCIÓN A GAS - PLACA CM.77X57. IGNICIÓN ELÉCTRICA, INDICADOR EXTERNO DE LLAMA PILOTO, CANAL PERIMETRAL INUNDABLE, DRENAJE CON FILTRO EXTRAÍBLE.</p> <p>cm. 90x 80x 31h</p>		12 kW 10.320 kcal/h	0,01 KW 230V~ 50/60 Hz	3.884,00 129 / 0,44
TPD-95G 29290550	<p>TUTTA PIASTRA GAS Piastra cm 39x73. Accensione elettrica, indicatore presenza fiamma pilota, canale perimetrale allagabile, scarico con filtro removibile.</p> <p>EN Solid top gas - Plate.39x73 cm. Electric ignition, flame presence indicator, floodable perimeter channel, drain with removable filter.</p> <p>• DE Gas-Kochplatte - Platte.39x73 cm. Elektrische Zündung, Flammenpräsenzanzeige, flutbaren Umfangskanal, Auspuff mit abnehmbarem Filter. • FR Toute plaque à gaz - Plaque cm.39x73. Allumage électrique, indicateur de présence de flamme, un conduit extérieur inondable, échappement avec filtre amovible. • ES PLACA DE COCCIÓN A GAS - PLACA CM.39X73. IGNICIÓN ELÉCTRICA, INDICADOR EXTERNO DE LLAMA PILOTO, CANAL PERIMETRAL INUNDABLE, DRENAJE CON FILTRO EXTRAÍBLE.</p> <p>cm. 50x 95x 31h</p>		7 kW 6.020 kcal/h	0,01 KW 230V~ 50/60 Hz	3.554,00 62 / 0,33
TPD-99G 29290950	<p>TUTTA PIASTRA GAS Piastra cm 79x73. Accensione elettrica, indicatore presenza fiamma pilota, canale perimetrale allagabile, scarico con filtro removibile.</p> <p>EN Solid top gas - Plate.79x73 cm. Electric ignition, flame presence indicator, floodable perimeter channel, drain with removable filter.</p> <p>• DE Gas-Kochplatte - Platte.79x73 cm. Elektrische Zündung, Flammenpräsenzanzeige, flutbaren Umfangskanal, Auspuff mit abnehmbarem Filter. • FR Toute plaque à gaz - Plaque cm.79x73. Allumage électrique, indicateur de présence de flamme, un conduit extérieur inondable, échappement avec filtre amovible. • ES PLACA DE COCCIÓN A GAS - PLACA CM.79X73. IGNICIÓN ELÉCTRICA, INDICADOR EXTERNO DE LLAMA PILOTO, CANAL PERIMETRAL INUNDABLE, DRENAJE CON FILTRO EXTRAÍBLE.</p> <p>cm. 90x 95x 31h</p>		12 kW 10.320 kcal/h	0,01 KW 230V~ 50/60 Hz	4.241,00 135 / 0,64

FRY-TOP A GAS 80

MOD. _____
COD. _____

DESCRIZIONE/DESCRIPTION/BEZEICHNUNG/DESCRIPTION/DESCRIPCIÓN
DIMENSIONI/DIMENSIONS/ABMESSUNGEN/DIMENSIONS/DIMENSIONES

POTENZA/POWER/LEISTUNG/PUISSANCE/POTENCIA
VOLTAGGIO/VOLTAGE/SPANNUNG/VOLTAGE/VOLTAJE

⚡ kW _____
kcal/h _____
⚡ kW _____
V~ _____
Hz _____

PREZZO/PRICE €
PREIS/PRIX/PRECIO €
KG / M³

FTLD-85GS
28230554

Fry-top gas liscio cromato SUPERCHROME (Moca Approved), piastra cm.39x53,5. Accensione elettrica, indicatore presenza fiamma pilota, canale perimetrale allagabile, scarico con filtro removibile.
EN Gas Fry-top smooth chromed griddle SUPERCHROME (Moca Approved), plate cm.39x53,5. Electric ignition, flame presence indicator, floodable perimeter channel, drain with removable filter. • **DE** Gas-griddleplatte glatt hartverchromt SUPERCHROME (Moca Approved), platte cm.39x53,5. Elektrische Zündung, Flammenpräsenzanzeige, flutbaren Umfangskanal, Auspuff mit abnehmbarem Filter. • **FR** Plaque gaz lisse chromée SUPERCHROME (Moca Approved), plaque cm.39x53,5. Allumage électrique, indicateur de présence de flamme, un conduit extérieur inondable, échappement avec filtre amovible. • **ES FRY-TOP GAS LISO CROMADO SUPERCHROME (MOCA APPROVED), PLANCHA CM.39X53,5. IGNICIÓN ELÉCTRICA, INDICADOR EXTERNO DE LLAMA PILOTO, CANAL PERIMETRAL INUNDABLE, DRENAJE CON FILTRO EXTRAÍBLE.**
cm. 50x 80x 33h



⚡ 7 kW _____ **3.147,00**
6.020 kcal/h _____ 53 / 0,33
⚡ 0,01 KW _____
230V~ _____
50/60 Hz _____



FTRD-85GS
28230556

Fry-top gas rigato cromato SUPERCHROME (Moca Approved), piastra cm.39x53,5. Accensione elettrica, indicatore presenza fiamma pilota, canale perimetrale allagabile, scarico con filtro removibile.
EN Gas Fry-top grooved chromed griddle SUPERCHROME (Moca Approved), plate cm.39x53,5. Electric ignition, flame presence indicator, floodable perimeter channel, drain with removable filter. • **DE** Gas-griddleplatte gerillt hartverchromt SUPERCHROME (Moca Approved), platte cm.39x53,5. Elektrische Zündung, Flammenpräsenzanzeige, flutbaren Umfangskanal, Auspuff mit abnehmbarem Filter. • **FR** Plaque gaz nervurée chromée SUPERCHROME (Moca Approved), plaque cm.39x53,5. Allumage électrique, indicateur de présence de flamme, un conduit extérieur inondable, échappement avec filtre amovible. • **ES FRY-TOP GAS ESTRIADO CROMADO SUPERCHROME (MOCA APPROVED), PLANCHA CM.39X53,5. IGNICIÓN ELÉCTRICA, INDICADOR EXTERNO DE LLAMA PILOTO, CANAL PERIMETRAL INUNDABLE, DRENAJE CON FILTRO EXTRAÍBLE.**
cm. 50x 80x 33h



⚡ 7 kW _____ **3.317,00**
6.020 kcal/h _____ 53 / 0,33
⚡ 0,01 KW _____
230V~ _____
50/60 Hz _____



FTLD-87GS
28230754

Fry-top gas liscio cromato SUPERCHROME (Moca Approved), piastra cm.59x53,5. Accensione elettrica, indicatore presenza fiamma pilota, canale perimetrale allagabile, scarico con filtro removibile.
EN Gas Fry-top smooth chromed griddle SUPERCHROME (Moca Approved), plate cm.59x53,5. Electric ignition, flame presence indicator, floodable perimeter channel, drain with removable filter. • **DE** Gas-griddleplatte glatt hartverchromt SUPERCHROME (Moca Approved), platte cm.59x53,5. Elektrische Zündung, Flammenpräsenzanzeige, flutbaren Umfangskanal, Auspuff mit abnehmbarem Filter. • **FR** Plaque gaz lisse chromée SUPERCHROME (Moca Approved), plaque cm.59x53,5. Allumage électrique, indicateur de présence de flamme, un conduit extérieur inondable, échappement avec filtre amovible. • **ES FRY-TOP GAS LISO CROMADO SUPERCHROME (MOCA APPROVED), PLANCHA CM.59X53,5. IGNICIÓN ELÉCTRICA, INDICADOR EXTERNO DE LLAMA PILOTO, CANAL PERIMETRAL INUNDABLE, DRENAJE CON FILTRO EXTRAÍBLE.**
cm. 70x 80x 33h



⚡ 10,5 kW _____ **3.308,00**
9.030 kcal/h _____ 62 / 0,35
⚡ 0,01 KW _____
230V~ _____
50/60 Hz _____

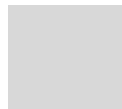

FRY-TOP A GAS 80

MOD. _____ DESCRIZIONE/DESCRIPTION/BEZEICHNUNG/DESCRIPTION/DESCRIPCIÓN POTENZA/POWER/LEISTUNG/PUISSANCE/POTENCIA ⚡ kW ⚡ kw PREZZO/PRICE €
 COD. _____ DIMENSIONI/DIMENSIONS/ABMESSUNGEN/DIMENSIONS/DIMENSIONES VOLTAGGIO/VOLTAGE/SPANNUNG/VOLTAGE/VOLTAJE kcal/h kcal/h V~ V~ PREIS/PRIX/PRECIO €
 KG / M³

FTLRD-87GS Fry-top gas 1/2 rigato + 1/2 liscio cromato SUPERCHROME (Moca Approved), piastra cm.59x53,5. Accensione elettrica, indicatore presenza fiamma pilota, canala perimetrale allagabile, scarico con filtro removibile.
EN Gas Fry-top 1/2 grooved + 1/2 smooth chromed griddle SUPERCHROME (Moca Approved), plate cm.59x53,5. Electric ignition, flame presence indicator, floodable perimeter channel, drain with removable filter. • **DE** Gas-griddleplatte 1/2 gerillt + 1/2 glatt hartverchromt SUPERCHROME (Moca Approved), platte cm.59x53,5. Elektrische Zündung, Flammenpräsenzanzeige, flutbaren Umfangskanal, Auspuff mit abnehmbarem Filter. • **FR** Plaque gaz 1/2 nervurée + 1/2 lisse chromée SUPERCHROME (Moca Approved), plaque cm.59x53,5. Allumage électrique, indicateur de présence de flamme, un conduit extérieur inondable, échappement avec filtre amovible. • **ES FRY-TOP GAS 1/2 ESTRIADO + 1/2 LISO CROMADO SUPERCHROME (MOCA APPROVED), PLANCHA CM.59X53,5. IGNICIÓN ELÉCTRICA, INDICADOR EXTERNO DE LLAMA PILOTO, CANAL PERIMETRAL INUNDABLE, DRENAJE CON FILTRO EXTRAÍBLE.**
cm. 70x 80x 33h



⚡ 10,5 kW **3.452,00**
 9.030 kcal/h 62 / 0,35
 ⚡ 0,01 KW
 230V~
 50/60 Hz



FTRD-87GS Fry-top gas rigato cromato SUPERCHROME (Moca Approved), piastra cm.59x53,5. Accensione elettrica, indicatore presenza fiamma pilota, canala perimetrale allagabile, scarico con filtro removibile.
EN Gas Fry-top grooved chromed griddle SUPERCHROME (Moca Approved), plate cm.59x53,5. Electric ignition, flame presence indicator, floodable perimeter channel, drain with removable filter. • **DE** Gas-griddleplatte gerillt hartverchromt SUPERCHROME (Moca Approved), platte cm.59x53,5. Elektrische Zündung, Flammenpräsenzanzeige, flutbaren Umfangskanal, Auspuff mit abnehmbarem Filter. • **FR** Plaque gaz nervurée chromée SUPERCHROME (Moca Approved), plaque cm.59x53,5. Allumage électrique, indicateur de présence de flamme, un conduit extérieur inondable, échappement avec filtre amovible. • **ES FRY-TOP GAS ESTRIADO CROMADO SUPERCHROME (MOCA APPROVED), PLANCHA CM.59X53,5. IGNICIÓN ELÉCTRICA, INDICADOR EXTERNO DE LLAMA PILOTO, CANAL PERIMETRAL INUNDABLE, DRENAJE CON FILTRO EXTRAÍBLE.**
cm. 70x 80x 33h



⚡ 10,5 kW **3.562,00**
 9.030 kcal/h 62 / 0,35
 ⚡ 0,01 KW
 230V~
 50/60 Hz

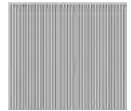

FTLD-89GS Fry-top gas liscio cromato SUPERCHROME (Moca Approved), piastra cm.79x53,5 - 2 zone di cottura. Accensione elettrica, indicatore presenza fiamma pilota, canala perimetrale allagabile, scarico con filtro removibile.
EN Gas Fry-top smooth chromed griddle SUPERCHROME (Moca Approved), plate cm.79x53,5 - 2 cooking areas. Electric ignition, flame presence indicator, floodable perimeter channel, drain with removable filter. • **DE** Gas-griddleplatte glatt hartverchromt SUPERCHROME (Moca Approved), platte cm.79x53,5 - 2 Heizzonen. Elektrische Zündung, Flammenpräsenzanzeige, flutbaren Umfangskanal, Auspuff mit abnehmbarem Filter. • **FR** Plaque gaz lisse chromée SUPERCHROME (Moca Approved), plaque cm.79x53,5 - 2 zones de cuisson. Allumage électrique, indicateur de présence de flamme, un conduit extérieur inondable, échappement avec filtre amovible. • **ES FRY-TOP GAS LISO CROMADO SUPERCHROME (MOCA APPROVED), PLANCHA CM.79X53,5 - 2 ZONAS DE COCCIÓN. IGNICIÓN ELÉCTRICA, INDICADOR EXTERNO DE LLAMA PILOTO, CANAL PERIMETRAL INUNDABLE, DRENAJE CON FILTRO EXTRAÍBLE.**
cm. 90x 80x 33h



⚡ 14 kW **4.218,00**
 12.040 kcal/h 98 / 0,44
 ⚡ 0,01 KW
 230V~
 50/60 Hz



FRY-TOP A GAS 80

MOD. _____
COD. _____

DESCRIZIONE/DESCRIPTION/BEZEICHNUNG/DESCRIPTION/DESCRIPCIÓN
DIMENSIONI/DIMENSIONS/ABMESSUNGEN/DIMENSIONS/DIMENSIONES

POTENZA/POWER/LEISTUNG/PUISSANCE/POTENCIA
VOLTAGGIO/VOLTAGE/SPANNUNG/VOLTAGE/VOLTAJE

⚡ kW _____
kcal/h _____
⚡ kW _____
230V~ _____
50/60 Hz _____

PREZZO/PRICE €
PREIS/PRIX/PRECIO €
KG / M³

FTLRD-89GS Fry-top gas 1/2 rigato + 1/2 liscio cromato SUPERCHROME (Moca Approved), piastra cm.79x53,5 - 2 zone di cottura. Accensione elettrica, indicatore presenza fiamma pilota, canale perimetrale allagabile, scarico con filtro removibile.
EN Gas Fry-top 1/2 grooved + 1/2 smooth chromed griddle SUPERCHROME (Moca Approved), plate cm.79x53,5 - 2 cooking areas. Electric ignition, flame presence indicator, floodable perimeter channel, drain with removable filter. • **DE** Gas-griddleplatte 1/2 gerillt + 1/2 glatt hartverchromt SUPERCHROME (Moca Approved), platte cm.79x53,5 - 2 Heizzonen. Elektrische Zündung, Flammenpräsenzanzeige, flutbaren Umfangskanal, Auspuff mit abnehmbarem Filter. • **FR** Plaque gaz 1/2 nervurée + 1/2 lisse chromée SUPERCHROME (Moca Approved), plaque cm.79x53,5 - 2 zones de cuisson. Allumage électrique, indicateur de présence de flamme, un conduit extérieur inondable, échappement avec filtre amovible. • **ES FRY-TOP GAS 1/2 ESTRIADO + 1/2 LISO CROMADO SUPERCHROME (MOCA APPROVED), PLANCHA CM.79X53,5 - 2 ZONAS DE COCCIÓN. IGNICIÓN ELÉCTRICA, INDICADOR EXTERNO DE LLAMA PILOTO, CANAL PERIMETRAL INUNDABLE, DRENAJE CON FILTRO EXTRAÍBLE.**
cm. 90x 80x 33h



⚡ 14 kW _____ **4.411,00**
12.040 kcal/h _____ 98 / 0,44
⚡ 0,01 KW _____
230V~ _____
50/60 Hz _____



FTRD-89GS Fry-top gas rigato cromato SUPERCHROME (Moca Approved), piastra cm.79x53,5 - 2 zone di cottura. Accensione elettrica, indicatore presenza fiamma pilota, canale perimetrale allagabile, scarico con filtro removibile.
EN Gas Fry-top grooved chromed griddle SUPERCHROME (Moca Approved), plate cm.79x53,5 - 2 cooking areas. Electric ignition, flame presence indicator, floodable perimeter channel, drain with removable filter. • **DE** Gas-griddleplatte gerillt hartverchromt SUPERCHROME (Moca Approved), platte cm.79x53,5 - 2 Heizzonen. Elektrische Zündung, Flammenpräsenzanzeige, flutbaren Umfangskanal, Auspuff mit abnehmbarem Filter. • **FR** Plaque gaz nervurée chromée SUPERCHROME (Moca Approved), plaque cm.79x53,5 - 2 zones de cuisson. Allumage électrique, indicateur de présence de flamme, un conduit extérieur inondable, échappement avec filtre amovible. • **ES FRY-TOP GAS ESTRIADO CROMADO SUPERCHROME (MOCA APPROVED), PLANCHA CM.79X53,5 - 2 ZONAS DE COCCIÓN. IGNICIÓN ELÉCTRICA, INDICADOR EXTERNO DE LLAMA PILOTO, CANAL PERIMETRAL INUNDABLE, DRENAJE CON FILTRO EXTRAÍBLE.C**
cm. 90x 80x 33h



⚡ 14 kW _____ **4.614,00**
12.040 kcal/h _____ 98 / 0,44
⚡ 0,01 KW _____
230V~ _____
50/60 Hz _____



FTLD-95GS Fry-top gas liscio cromato SUPERCHROME (Moca Approved), piastra cm.39x68,5. Accensione elettrica, indicatore presenza fiamma pilota, canale perimetrale allagabile, scarico con filtro removibile.
EN Gas Fry-top smooth chromed griddle SUPERCHROME (Moca Approved), plate cm.39x68,5. Electric ignition, flame presence indicator, floodable perimeter channel, drain with removable filter. • **DE** Gas-griddleplatte glatt hartverchromt SUPERCHROME (Moca Approved), platte cm.39x68,5. Elektrische Zündung, Flammenpräsenzanzeige, flutbaren Umfangskanal, Auspuff mit abnehmbarem Filter. • **FR** Plaque gaz lisse chromée SUPERCHROME (Moca Approved), plaque cm.39x68,5. Allumage électrique, indicateur de présence de flamme, un conduit extérieur inondable, échappement avec filtre amovible. • **ES FRY-TOP GAS LISO CROMADO SUPERCHROME (MOCA APPROVED), PLANCHA CM.39X68,5. IGNICIÓN ELÉCTRICA, INDICADOR EXTERNO DE LLAMA PILOTO, CANAL PERIMETRAL INUNDABLE, DRENAJE CON FILTRO EXTRAÍBLE.**
cm. 50x 95x 33h



⚡ 9 kW _____ **3.623,00**
7.744 kcal/h _____ 61 / 0,33
⚡ 0,01 KW _____
230V~ _____
50/60 Hz _____



FRY-TOP A GAS 90

MOD. _____
COD. _____

DESCRIZIONE/DESCRIPTION/BEZEICHNUNG/DESCRIPTION/DESCRIPCIÓN
DIMENSIONI/DIMENSIONS/ABMESSUNGEN/DIMENSIONS/DIMENSIONES

POTENZA/POWER/LEISTUNG/PUISSANCE/POTENCIA
VOLTAGGIO/VOLTAGE/SPANNUNG/VOLTAGE/VOLTAJE

⚡ kW kcal/h ⚡ kW V~ Hz

PREZZO/PRICE € PREIS/PRIX/PRECIO € KG / M³

FTRD-95GS
29230556

Fry-top gas rigato cromato SUPERCHROME (Moca Approved), piastra cm.39x68,5. Accensione elettrica, indicatore presenza fiamma pilota, canale perimetrale allagabile, scarico con filtro removibile.
EN Gas Fry-top grooved chromed griddle SUPERCHROME (Moca Approved), plate cm.39x68,5. Electric ignition, flame presence indicator, floodable perimeter channel, drain with removable filter. • **DE** Gas-griddleplatte gerillt hartverchromt SUPERCHROME (Moca Approved), platte cm.39x68,5. Elektrische Zündung, Flammenpräsenzanzeige, flutbaren Umfangskanal, Auspuff mit abnehmbarem Filter. • **FR** Plaque gaz nervurée chromée SUPERCHROME (Moca Approved), plaque cm.39x68,5. Allumage électrique, indicateur de présence de flamme, un conduit extérieur inondable, échappement avec filtre amovible.
• **ES FRY-TOP GAS ESTRIADO CROMADO SUPERCHROME (MOCA APPROVED), PLANCHA CM.39X68,5. IGNICIÓN ELÉCTRICA, INDICADOR EXTERNO DE LLAMA PILOTO, CANAL PERIMETRAL INUNDABLE, DRENAJE CON FILTRO EXTRAÍBLE.**
cm. 50x 95x 33h



⚡ 9 kW 3.815,00
7.7440 kcal/h 61 / 0,33
⚡ 0,01 KW
230V~
50/60 Hz



FTLD-99GS
29230954

Fry-top gas liscio cromato SUPERCHROME (Moca Approved), piastra cm.79x68,5 - 2 zone di cottura. Accensione elettrica, indicatore presenza fiamma pilota, canale perimetrale allagabile, scarico con filtro removibile.
EN Gas Fry-top smooth chromed griddle SUPERCHROME (Moca Approved), plate cm.79x68,5 - 2 cooking areas. Electric ignition, flame presence indicator, floodable perimeter channel, drain with removable filter. • **DE** Gas-griddleplatte glatt hartverchromt SUPERCHROME (Moca Approved), platte cm.79x68,5 - 2 Heizzonen. Elektrische Zündung, Flammenpräsenzanzeige, flutbaren Umfangskanal, Auspuff mit abnehmbarem Filter. • **FR** Plaque gaz lisse chromée SUPERCHROME (Moca Approved), plaque cm.79x68,5 - 2 zones de cuisson. Allumage électrique, indicateur de présence de flamme, un conduit extérieur inondable, échappement avec filtre amovible. • **ES FRY-TOP GAS LISO CROMADO SUPERCHROME (MOCA APPROVED), PLANCHA CM.79X68,5 - 2 ZONAS DE COCCIÓN. IGNICIÓN ELÉCTRICA, INDICADOR EXTERNO DE LLAMA PILOTO, CANAL PERIMETRAL INUNDABLE, DRENAJE CON FILTRO EXTRAÍBLE.**
cm. 90x 95x 33h



⚡ 18 kW 5.148,00
15.480 kcal/h 102 / 0,64
⚡ 0,01 KW
230V~
50/60 Hz



FTLRD-99GS
29230955

Fry-top gas 1/2 rigato + 1/2 liscio cromato SUPERCHROME (Moca Approved), piastra cm.79x68,5 - 2 zone di cottura. Accensione elettrica, indicatore presenza fiamma pilota, canale perimetrale allagabile, scarico con filtro removibile.
EN Gas Fry-top 1/2 grooved + 1/2 smooth chromed griddle SUPERCHROME (Moca Approved), plate cm.79x68,5 - 2 cooking areas. Electric ignition, flame presence indicator, floodable perimeter channel, drain with removable filter. • **DE** Gas-griddleplatte 1/2 gerillt + 1/2 glatt hartverchromt SUPERCHROME (Moca Approved), platte cm.79x68,5 - 2 Heizzonen. Elektrische Zündung, Flammenpräsenzanzeige, flutbaren Umfangskanal, Auspuff mit abnehmbarem Filter. • **FR** Plaque gaz 1/2 nervurée + 1/2 lisse chromée SUPERCHROME (Moca Approved), plaque cm.79x68,5 - 2 zones de cuisson. Allumage électrique, indicateur de présence de flamme, un conduit extérieur inondable, échappement avec filtre amovible. • **ES FRY-TOP GAS 1/2 ESTRIADO + 1/2 LISO CROMADO SUPERCHROME (MOCA APPROVED), PLANCHA CM.79X68,5 - 2 ZONAS DE COCCIÓN. IGNICIÓN ELÉCTRICA, INDICADOR EXTERNO DE LLAMA PILOTO, CANAL PERIMETRAL INUNDABLE, DRENAJE CON FILTRO EXTRAÍBLE.**
cm. 90x 95x 33h



⚡ 18 kW 5.386,00
15.480 kcal/h 102 / 0,64
⚡ 0,01 KW
230V~
50/60 Hz



FRY-TOP A GAS 90

MOD. _____
COD. _____

DESCRIZIONE/DESCRIPTION/BEZEICHNUNG/DESCRIPTION/DESCRIPCIÓN
DIMENSIONI/DIMENSIONS/ABMESSUNGEN/DIMENSIONS/DIMENSIONES

POTENZA/POWER/LEISTUNG/PUISSANCE/POTENCIA
VOLTAGGIO/VOLTAGE/SPANNUNG/VOLTAGE/VOLTAJE

⚡ kW _____
kcal/h _____
⚡ kW _____
V~ _____
Hz _____

PREZZO/PRICE €
PREIS/PRIX/PRECIO €
KG / M³

FTRD-99GS
29230956

Fry-top gas rigato cromato SUPERCHROME (Moca Approved), piastra cm.79x68,5 - 2 zone di cottura. Accensione elettrica, indicatore presenza fiamma pilota, canale perimetrale allagabile, scarico con filtro removibile.
EN Gas Fry-top grooved chromed griddle SUPERCHROME (Moca Approved), plate cm.79x68,5 - 2 cooking areas. Electric ignition, flame presence indicator, floodable perimeter channel, drain with removable filter. • **DE** Gas-griddleplatte gerillt hartverchromt SUPERCHROME (Moca Approved), platte cm.79x68,5 - 2 Heizzonen. Elektrische Zündung, Flammenpräsenzanzeige, flutbaren Umfangskanal, Auspuff mit abnehmbarem Filter. • **FR** Plaque gaz nervurée chromée SUPERCHROME (Moca Approved), plaque cm.79x68,5 - 2 zones de cuisson. Allumage électrique, indicateur de présence de flamme, un conduit extérieur inondable, échappement avec filtre amovible. • **ES FRY-TOP GAS ESTRIADO CROMADO SUPERCHROME (MOCA APPROVED), PLANCHA CM.79X68,5 - 2 ZONAS DE COCCIÓN. IGNICIÓN ELÉCTRICA, INDICADOR EXTERNO DE LLAMA PILOTO, CANAL PERIMETRAL INUNDABLE, DRENAJE CON FILTRO EXTRAÍBLE.**
cm. 90x 95x 33h



⚡ 18 kW _____ **5.622,00**
15.480 kcal/h _____ 102 / 0,64

⚡ 0,01 kW _____
230V~ _____
50/60 Hz _____



LAD-64
26020400

LAVELLO Rubinetto a leva - Vasca cm.29x35x20h
EN Sink unit - Lever type tap. Bowl cm.29x35x20h • **DE** Spülbecken Einhebel-Mischbatterie - Becken cm.29x35x20h • **FR** Bac-évier avec robinetterie - Bac cm.29x35x20h • **ES FREGADERO - GRIFO A PALANCA - PILETA CM.29X35X20H**
cm. 40x 60x 35h



996,00
15 / 0,13

OPT-GA

ACCENSIONE ELETTRICA per apparecchi gas: PCD-64GA, PCD-68GA (prezzo a bruciatore)
EN electric ignition for gas model: PCD-64GA, PCD-68GA (PRICE FOR 1 BURNER) • **DE** elektrische Zündung für gas modell: PCD-64GA, PCD-68GA (PREIS FÜR 1 BRENNER) • **FR** allumage électrique pour modèle a gaz: PCD-64GA, PCD-68GA (PRIX POUR 1 BRÛLEUR) • **ES IGNICIÓN ELÉCTRICA PARA MODELO GAS: PCD-64GA, PCD-68GA (PRECIO POR 1 QUEMADOR)**



⚡ 0,01 kW _____ **270,00**
230V~ _____ /
50/60 Hz _____

532005901

GRIGLIA 1 FUOCO
EN 1 flame grill • **DE** Rost 1 flamme • **FR** Frille 1 feu • **ES PARILLA 1 QUEMADOR**

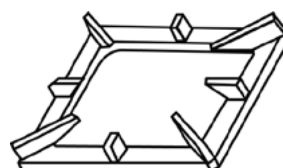

116,00
3 / 0,01

PLF
07590401

PIASTRA LISCIA per GRIGLIA IN GHISA
EN Smooth griddle plate for cast iron grid • **DE** Fortkochplatte glatt für Gusseisen Rost • **FR** Plaque lisse pour la grille en fonte • **ES PLANCHA LISA PARA REJILLA DE HIERRO FUNDIDO**
cm. 35x 27



205,00
9 / 0,01

PLF/2
07590421

PIASTRA LISCIA 2 FUOCHI per GRIGLIA IN GHISA
EN Smooth griddle plate 2 burners for cast iron grid • **DE** Fortkochplatte glatt 2 Kochstellen für Gusseisen Rost • **FR** Plaque lisse 2 feux pour la grille en fonte • **ES PLANCHA LISA 2 QUEMADORES PARA REJILLA DE HIERRO FUNDIDO**
cm. 35x 57

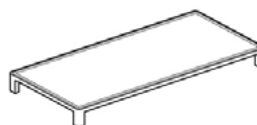

405,00
18 / 0,01





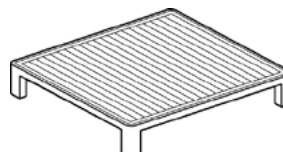

PRF
07590403

PIASTRA RIGATA per GRIGLIA IN GHISA
EN Grooved griddle plate for cast iron grid • **DE** Fortkochplatte gerillt für Gusseisen Rost • **FR** Plaque nervurée pour la grille en fonte • **ES PLANCHA ESTRIADA PARA REJILLA DE HIERRO FUNDIDO**
cm. 35x 27

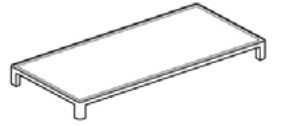
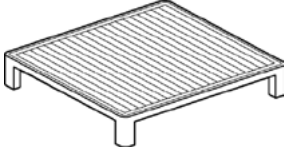

274,00
9 / 0,01

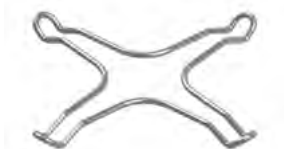
ACCESSORI

MOD. COD.	DESCRIZIONE/DESCRIPTION/BEZEICHNUNG/DESCRIPTION/DESCRIPCIÓN DIMENSIONI/DIMENSIONS/ABMESSUNGEN/DIMENSIONS/DIMENSIONES	POTENZA/POWER/LEISTUNG/PUISSANCE/POTENCIA VOLTAGGIO/VOLTAGE/SPANNUNG/VOLTAGE/VOLTAJE kW kcal/h V~ Hz	PREZZO/PRICE € PREIS/PRIX/PRECIO KG / M³
PRF/2 07590423	PIASTRA RIGATA 2 FUOCHI per GRIGLIA IN GHISA EN Grooved griddle plate 2 burners for cast iron grid • DE Fortkochplatte gerillt 2 Kochstellen für Gusseisen Rost • FR Plaque nervurée 2 feux pour la grille en fonte • ES PLANCHA ESTRIADA 2 QUEMADORES PARA REJILLA DE HIERRO FUNDIDO cm. 35x 57		450,00 18 / 0,01
PLFT/7 08590451	PIASTRA LISCIA per GRIGLIA IN TONDINO EN Smooth griddle plate for grid rod • DE Fortkochplatte glatt für Gitterstab • FR Plaque lisse pour tige grille • ES PLANCHA LISA POR RED DE VARILLA cm. 35x 27		205,00 9 / 0,01
PLFT/72 08590471	PIASTRA LISCIA 2 FUOCHI per GRIGLIA IN TONDINO EN Smooth griddle plate 2 burners for grid rod • DE Fortkochplatte glatt 2 Kochstellen für Gitterstab • FR Plaque lisse 2 feux pour tige grille • ES PLANCHA LISA 2 QUEMADORES POR RED DE VARILLA cm. 35x 57		405,00 18 / 0,01
PRFT/7 08590453	PIASTRA RIGATA per GRIGLIA IN TONDINO EN Grooved griddle plate for grid rod • DE Fortkochplatte gerillt für Gitterstab • FR Plaque nervurée pour tige grille • ES PLANCHA ESTRIADA POR RED DE VARILLA cm. 35x 27		274,00 9 / 0,01
PRFT/72 08590473	PIASTRA RIGATA 2 FUOCHI per GRIGLIA IN TONDINO EN Grooved griddle plate 2 burners for grid rod • DE Fortkochplatte gerillt 2 Kochstellen für Gitterstab • FR Plaque nervurée 2 feux pour tige grille • ES PLANCHA ESTRIADA 2 QUEMADORES POR RED DE VARILLA cm. 35x 57		450,00 18 / 0,01
KIT-WOK 09580040	KIT WOK - fiamma verticale - solo su bruciatore da 10 KW e griglie in ghisa EN KIT WOK - vertical flame - only for 10 kW burner and cast iron grills • DE KIT WOK - vertikaler Flamme - nur 10 kW-Brenner und Roste aus Gusseisen • FR KIT WOK - verticale de la flamme - seulement 10 kW brûleur et grilles en fonte • ES KIT WOK - LLAMA VERTICAL - SÓLO 10 KW QUEMADOR Y PARRILAS DE HIERRO COLADO cm. Ø 26x 16h		456,00 5 / 0,02
533009200	GRIGLIA DI RIDUZIONE EN Reduction • DE Reduzierstern • FR Grille de réduction • ES REJILLA DE REDUCCIÓN cm. 25x 25		43,00 0.2 / 0,00
531070200	CESTO 1/1 PER CPD-64 - 2/3 PER CPD-84 EN Basket 1/1 for CPD-64 - 2/3 for CPD-84 • DE Korb 1/1 für CPD-64 - 2/3 für CPD-84 • FR Panier 1/1 pour CPD-64 - 2/3 pour CPD-84 • ES CESTA 1/1 PARA CPD-64 - 2/3 PARA CPD-84 cm. 28x 32x 21,5h		185,00 2 / 0,06

ACCESSORI CUOCIPASTA

MOD. _____
COD. _____

DESCRIZIONE/DESCRIPTION/BEZEICHNUNG/DESCRIPTION/DESCRIPCIÓN
DIMENSIONI/DIMENSIONS/ABMESSUNGEN/DIMENSIONS/DIMENSIONES

POTENZA/POWER/LEISTUNG/PUISSANCE/POTENCIA
VOLTAGGIO/VOLTAGE/SPANNUNG/VOLTAGE/VOLTAJE

⚡ kW kcal/h ⚡ kw V~ Hz

PREZZO/PRICE €
PREIS/PRIX/PRECIO €
KG / M³

531032400 CESTO 1/2 PER CPD-64
EN Basket 1/2 for CPD-64 • **DE** Korb 1/2 für CPD-64 • **FR** Panier 1/2 pour CPD-64 • **ES CESTA 1/2 PARA CPD-64**
cm. **14x 32x 20h**

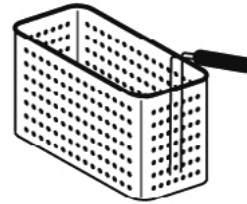

..324..

127,00
1.5 / 0,05

531047900 CESTO 1/2 PER CPD-64 - 1/3 PER CPD-84
EN Basket 1/2 for CPD-64 - 1/3 for CPD-84 • **DE** Korb 1/2 für CPD-64 - 1/3 für CPD-84 • **FR** Panier 1/2 pour CPD-64 - 1/3 pour CPD-84 • **ES CESTA 1/2 PARA CPD-64 - 1/3 PARA CPD-84**
cm. **28x 16x 21,5h**



133,00
1.5 / 0,04

531048000 CESTO 1/4 PER CPD-64 - 1/6 PER CPD-84
EN Basket 1/4 for CPD-64 - 1/6 for CPD-84 • **DE** Korb 1/4 für CPD-64 - 1/6 für CPD-84 • **FR** Panier 1/4 pour CPD-64 - 1/6 pour CPD-84 • **ES CESTA 1/4 PARA CPD-64 - 1/6 PARA CPD-84**
cm. **13,5x 16x 21,5h**



102,00
1 / 0,02

531032600 CESTO 1/6 PER CPD-64
EN Basket 1/6 for CPD-64 • **DE** Korb 1/6 für CPD-64 • **FR** Panier 1/6 pour CPD-64 • **ES CESTA 1/6 PARA CPD-64**
cm. **14x 10x 20h**



..326..

90,00
0.7 / 0,02

531070300 CESTO 1/1 PER CPD-84
EN Basket 1/1 for CPD-84 • **DE** Korb 1/1 für CPD-84 • **FR** Panier 1/1 pour CPD-84 • **ES CESTA 1/1 PARA CPD-84**
cm. **28x 49x 21,5h**



268,00
3,5 / 0,08

531070100 CESTO 1/2 PER CPD-84
EN Basket 1/2 for CPD-84 • **DE** Korb 1/2 für CPD-84 • **FR** Panier 1/2 pour CPD-84 • **ES CESTA 1/2 PARA CPD-84**
cm. **28x 24x 21,5h**



167,00
1 / 0,05

ACCESSORI CUOCIPASTA

MOD. COD.	DESCRIZIONE/DESCRIPTION/BEZEICHNUNG/DESCRIPTION/DESCRIPCIÓN DIMENSIONI/DIMENSIONS/ABMESSUNGEN/DIMENSIONS/DIMENSIONES	POTENZA/POWER/LEISTUNG/PUISSANCE/POTENCIA VOLTAGGIO/VOLTAGE/SPANNUNG/VOLTAGE/VOLTAJE	$\frac{kW}{kcal/h}$ $\frac{kW}{V\sim}$ Hz	PREZZO/PRICE € KG / M ³
---------------------	---	---	--	--

531071100 CESTO CON GANCIO 1/2 PER CPD-64
EN Basket with hook 1/2 for CPD-64 • **DE** Korb mit Haken 1/2 für CPD-64 • **FR** Panier avec crochet 1/2 pour CPD-64 • **ES CESTA CON GANCHO 1/2 PARA CPD-64**
cm. 14,5x 29x 20h



179,00
1.5 / 0,05

531069300 GRIGLIA SUPPORTO CESTI CON GANCIO PER CPD-64
EN support for baskets with hook for CPD-64 • **DE** Unterstützung für Körbe mit Haken für CPD-64 • **FR** soutien pour les paniers avec crochet pour CPD-64 • **ES SOPORTE PARA CESTAS CON GANCHO PARA CPD-64**
cm. 30x 33x 41h



152,00
3.5 / 0,06

08550400 COPERCHIO BRFD-64
EN Lid BRFD-64 • **DE** Deckel BRFD-64 • **FR** Couvercle BRFD-64 • **ES TAPA BRFD-64**
cm. 32x 53x 5h

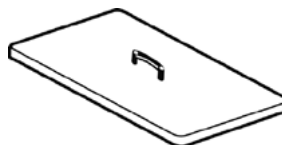

154,00
2 / 0,02

531013200 CESTO 1/2 PER F10D-E
EN Basket 1/2 for F10D-E • **DE** Korb 1/2 for F10D-E • **FR** Panier 1/2 for F10D-E • **ES CESTA 1/2 FOR F10D-E**
cm. 10x 30x 12h



63,00
0.7 / 0,03

531041600 CESTINO 1/2 per F18D-64E
EN Basket 1/2 for F18D-64E • **DE** Korb 1/2 zur Friteuse F18D-64E • **FR** Panier 1/2 pour F18D-64E • **ES CESTA 1/2 PARA F18D-64E**
cm. 13,5x 29x 15h



84,00
0.8 / 0,04



○ PUERTAS Y ZÓCALOS OPCIONALES ○

ESTRUCTURAS SUSPENDIDAS

LOTUS®





STRUTTURE SBALZO 1 LATO S90



MOD. COD.	DESCRIZIONE/DESCRIPTION/BEZEICHNUNG/DESCRIPTION/DESCRIPCIÓN DIMENSIONI/DIMENSIONS/ABMESSUNGEN/DIMENSIONS/DIMENSIONES	POTENZA/POWER/LEISTUNG/PUISSANCE/POTENCIA VOLTAGGIO/VOLTAGE/SPANNUNG/VOLTAGE/VOLTAJE	⚡ kcal/h	⚡ V~ Hz	PREZZO/PRICE € PREIS/PRIX/PRECIO € KG / M³
SB90T-2,0 01509200	STRUTTURA SBALZO 1 LATO SERIE 90T, 1 piede per fissaggio a terra EN CANTILEVER STRUCTURE 1 side S90T, 1 foot for ground fixing • DE BRÜCKENSTRUKTURE 1 seite S90T, 1 steher für bodenverankerung • FR STRUCTURE SUSPENDUES 1 coté S90T, 1 pied pour le fixage au sol • ES ESTRUCTURA Suspendida 1 LADO S90T, 1 PATA PARA FIJACION AL SUELO cm. 200x113,1x 90h				4.588,00 113 / 1,62
SB90T-2,4 01509240	cm. 240x113,1x 90h				4.925,00 123 / 1,93
SB90T-2,8 01509280	STRUTTURA SBALZO 1 LATO SERIE 90T, 2 piedi per fissaggio a terra EN CANTILEVER STRUCTURE 1 side S90T, 2 feet for ground fixing • DE BRÜCKENSTRUKTURE 1 seite S90T, 2 stehern für bodenverankerung • FR STRUCTURE SUSPENDUES 1 coté S90T, 2 pieds pour le fixage au sol • ES ESTRUCTURA Suspendida 1 LADO S90T, 2 PATAS PARA FIJACION AL SUELO cm. 280x113,1x 90h				6.972,00 194 / 2,23
SB90T-3,2 01509320	cm. 320x113,1x 90h				7.309,00 221 / 2,54
SB90T-3,6 01509360	cm. 360x113,1x 90h				7.646,00 242 / 2,85
SB90T-4,0 01509400	cm. 400x113,1x 90h				7.984,00 263 / 3,16
SB90T-4,4 01509440	cm. 440x113,1x 90h				8.321,00 290 / 3,47
SB90T-4,8 01509480	cm. 480x113,1x 90h				8.658,00 311 / 3,77
SB90T-5,2 01509520	cm. 520x113,1x 90h				8.997,00 338 / 4,08
SB90T-5,6 01509560	cm. 560x113,1x 90h				9.334,00 359 / 4,39
SB90T-6,0 01509600	cm. 600x113,1x 90h				9.672,00 380 / 4,70
SB99T-2,0 01599200	STRUTTURA SBALZO 2 LATI SERIE 90T, 1 piede per fissaggio a terra EN CANTILEVER STRUCTURE 2 sides S90T, 1 foot for ground fixing • DE BRÜCKENSTRUKTURE 2 seiten S90T, 1 steher für bodenverankerung • FR STRUCTURE SUSPENDUES 2 cotés S90T, 1 pied pour le fixage au sol • ES ESTRUCTURA Suspendida 2 LADOS S90T, 1 PATA PARA FIJACION AL SUELO cm. 200x 200x 90h				5.071,00 136 / 2,79
SB99T-2,4 01599240	cm. 240x 200x 90h				5.521,00 149 / 3,33
SB99T-2,8 01599280	STRUTTURA SBALZO 2 LATI SERIE 90T, 2 piedi per fissaggio a terra EN CANTILEVER STRUCTURE 2 sides S90T, 2 feet for ground fixing • DE BRÜCKENSTRUKTURE 2 seiten S90T, 2 stehern für bodenverankerung • FR STRUCTURE SUSPENDUES 2 cotés S90T, 2 pieds pour le fixage au sol • ES ESTRUCTURA Suspendida 2 LADOS S90T, 2 PATAS PARA FIJACION AL SUELO cm. 280x 200x 90h				7.616,00 226 / 3,86



STRUTTURE SBALZO 2 LATI S90

MOD. COD.	DESCRIZIONE/DESCRIPTION/BEZEICHNUNG/DESCRIPTION/DESCRIPCIÓN DIMENSIONI/DIMENSIONS/ABMESSUNGEN/DIMENSIONS/DIMENSIONES	POTENZA/POWER/LEISTUNG/PUISSANCE/POTENCIA VOLTAGGIO/VOLTAGE/SPANNUNG/VOLTAGE/VOLTAJE	⚡ kW kcal/h	⚡ kw V~ Hz	PREZZO/PRICE PREIS/PRIX/PRECIO € KG / M ³
SB99T-3,2 01599320	cm. 320x 200x 90h				8.065,00 257 / 4,39
SB99T-3,6 01599360	cm. 360x 200x 90h				8.516,00 281 / 4,92
SB99T-4,0 01599400	cm. 400x 200x 90h				8.965,00 305 / 5,45
SB99T-4,4 01599440	cm. 440x 200x 90h				9.411,00 336 / 5,99
SB99T-4,8 01599480	cm. 480x 200x 90h				9.860,00 360 / 6,52
SB99T-5,2 01599520	cm. 520x 200x 90h				10.311,00 391 / 7,05
SB99T-5,6 01599560	cm. 560x 200x 90h				10.760,00 415 / 7,58
SB99T-6,0 01599600	cm. 600x 200x 90h				11.209,00 440 / 8,11
SB70T-2,0 01507200	STRUTTURA SBALZO 1 LATO SERIE 70T, 1 piede per fissaggio a terra EN CANTILEVER STRUCTURE 1 side S70T, 1 foot for ground fixing • DE BRÜCKENSTRUKTURE 1 seite S70T, 1 steher für bodenverankerung • FR STRUCTURE SUSPENDUES 1 coté S70T, 1 pied pour le fixage au sol • ES ESTRUCTURA Suspendida 1 LADO S70T, 1 PATA PARA FIJACION AL SUELO cm. 200x 93,6x 90h				4.588,00 110 / 1,32
SB70T-2,4 01507240	cm. 240x 93,6x 90h				4.925,00 120 / 1,58
SB70T-2,8 01507280	STRUTTURA SBALZO 1 LATO SERIE 70T, 2 piedi per fissaggio a terra EN CANTILEVER STRUCTURE 1 side S70T, 2 feet for ground fixing • DE BRÜCKENSTRUKTURE 1 seite S70T, 2 stehern für bodenverankerung • FR STRUCTURE SUSPENDUES 1 coté S70T, 2 pieds pour le fixage au sol • ES ESTRUCTURA Suspendida 1 LADO S70T, 2 PATAS PARA FIJACION AL SUELO cm. 280x 93,6x 90h				6.972,00 191 / 1,83
SB70T-3,2 01507320	cm. 320x 93,6x 90h				7.309,00 217 / 2,08
SB70T-3,6 01507360	cm. 360x 93,6x 90h				7.646,00 238 / 2,33
SB70T-4,0 01507400	cm. 400x 93,6x 90h				7.984,00 259 / 2,58
SB70T-4,4 01507440	cm. 440x 93,6x 90h				8.321,00 285 / 2,84
SB70T-4,8 01507480	cm. 480x 93,6x 90h				8.658,00 306 / 3,09
SB70T-5,2 01507520	cm. 520x 93,6x 90h				8.997,00 332 / 3,34

STRUTTURE SBALZO 1 LATO S70

MOD. COD.	DESCRIZIONE/DESCRIPTION/BEZEICHNUNG/DESCRIPTION/DESCRIPCIÓN DIMENSIONI/DIMENSIONS/ABMESSUNGEN/DIMENSIONS/DIMENSIONES	POTENZA/POWER/LEISTUNG/PUISSANCE/POTENCIA VOLTAGGIO/VOLTAGE/SPANNUNG/VOLTAGE/VOLTAGE	⊕kW kcal/h	⊖kW V~ Hz	PREZZO/PRICE € PREIS/PRIX/PRECIO € KG / M³
SB70T-5,6 01507560	cm. 560x 93,6x 90h				9.334,00 353 / 3,59
SB70T-6,0 01507600	cm. 600x 93,6x 90h				9.672,00 374 / 3,84
					
SB77T-2,0 01577200	STRUTTURA SBALZO 2 LATI SERIE 70T, 1 piede per fissaggio a terra EN CANTILEVER STRUCTURE 2 sides S70T, 1 foot for ground fixing • DE BRÜCKENSTRUKTURE 2 seiten S70T, 1 steher für bodenverankerung • FR STRUCTURE SUSPENDUES 2 cotés S70T, 1 pied pour le fixage au sol • ES ESTRUCTURA Suspendida 2 LADOS S70T, 1 PATA PARA FIJACION AL SUELO cm. 200x 161x 90h				5.071,00 130 / 2,21
					
SB77T-2,4 01577240	cm. 240x 161x 90h				5.521,00 143 / 2,63
SB77T-2,8 01577280	STRUTTURA SBALZO 2 LATI SERIE 70T, 2 piedi per fissaggio a terra EN CANTILEVER STRUCTURE 2 sides S70T, 2 feet for ground fixing • DE BRÜCKENSTRUKTURE 2 seiten S70T, 2 stehern für bodenverankerung • FR STRUCTURE SUSPENDUES 2 cotés S70T, 2 pieds pour le fixage au sol • ES ESTRUCTURA Suspendida 2 LADOS S70T, 2 PATAS PARA FIJACION AL SUELO cm. 280x 161x 90h				7.616,00 218 / 3,05
SB77T-3,2 01577320	cm. 320x 161x 90h				8.065,00 248 / 3,47
SB77T-3,6 01577360	cm. 360x 161x 90h				8.516,00 272 / 3,89
SB77T-4,0 01577400	cm. 400x 161x 90h				8.965,00 296 / 4,31
SB77T-4,4 01577440	cm. 440x 161x 90h				9.411,00 326 / 4,73
SB77T-4,8 01577480	cm. 480x 161x 90h				9.860,00 350 / 5,15
SB77T-5,2 01577520	cm. 520x 161x 90h				10.311,00 380 / 5,57
SB77T-5,6 01577560	cm. 560x 161x 90h				10.760,00 404 / 5,99
SB77T-6,0 01577600	cm. 600x 161x 90h				11.209,00 428 / 6,41

STRUTTURE SBALZO 2 LATI S90 E 70

MOD. COD.	DESCRIZIONE/DESCRIPTION/BEZEICHNUNG/DESCRIPTION/DESCRIPCIÓN DIMENSIONI/DIMENSIONS/ABMESSUNGEN/DIMENSIONS/DIMENSIONES	POTENZA/POWER/LEISTUNG/PUISSANCE/POTENCIA VOLTAGGIO/VOLTAGE/SPANNUNG/VOLTAGE/VOLTAJE	kw kcal/h	kw V~ Hz	PREZZO/PRICE € PREIS/PRIX/PRECIO € KG / M³
SB79T-2,0 01579200	STRUTTURA SBALZO 2 LATI SERIE 70T/90T, 1 piede per fissaggio a terra EN CANTILEVER STRUCTURE 2 sides S70T/90T, 1 foot for ground fixing • DE BRÜCKENSTRUKTURE 2 seiten S70T/90T, 1 steher für bodenverankerung • FR STRUCTURE SUSPENDUES 2 cotés S70T/90T, 1 pied pour le fixage au sol • ES ESTRUCTURA Suspendida 2 LADOS S70T/90T, 1 PATA PARA FIJACION AL SUELO cm. 200x180,5x 90h				5.071,00 133 / 2,50
SB79T-2,4 01579240	cm. 240x180,5x 90h				5.521,00 146 / 2,98
SB79T-2,8 01579280	STRUTTURA SBALZO 2 LATI SERIE 70T/90T, 2 piedi per fissaggio a terra EN CANTILEVER STRUCTURE 2 sides S70T/90T, 2 feet for ground fixing • DE BRÜCKENSTRUKTURE 2 seiten S70T/90T, 2 stehern für bodenverankerung • FR STRUCTURE SUSPENDUES 2 cotés S70T/90T, 2 pieds pour le fixage au sol • ES ESTRUCTURA Suspendida 2 LADOS S70T/90T, 2 PATAS PARA FIJACION AL SUELO cm. 280x180,5x 90h				7.616,00 222 / 3,45
SB79T-3,2 01579320	cm. 320x180,5x 90h				8.065,00 253 / 3,93
SB79T-3,6 01579360	cm. 360x180,5x 90h				8.516,00 277 / 4,40
SB79T-4,0 01579400	cm. 400x180,5x 90h				8.965,00 301 / 4,88
SB79T-4,4 01579440	cm. 440x180,5x 90h				9.411,00 331 / 5,36
SB79T-4,8 01579480	cm. 480x180,5x 90h				9.860,00 355 / 5,83
SB79T-5,2 01579520	cm. 520x180,5x 90h				10.311,00 386 / 6,31
SB79T-5,6 01579560	cm. 560x180,5x 90h				10.760,00 410 / 6,78
SB79T-6,0 01579600	cm. 600x180,5x 90h				11.209,00 434 / 7,26
SB90T-2,8A 01509281	STRUTTURA SBALZO 1 LATO SERIE 90T, 2 piedi autoportanti EN CANTILEVER STRUCTURE 1 side S90T, 2 self-supporting feet • DE BRÜCKENSTRUKTURE 1 seite S90T, 2 stehern für selbsttragende Struktur • FR STRUCTURE SUSPENDUES 1 coté S90T, 2 pieds autoportantes • ES ESTRUCTURA Suspendida 1 LADO S90T, 2 PATAS AUTOPORTANTES cm. 280x113,1x 90h				8.432,00 194 / 2,23
SB90T-3,2A 01509321	cm. 320x113,1x 90h				8.769,00 221 / 2,54
SB90T-3,6A 01509361	cm. 360x113,1x 90h				9.108,00 242 / 2,85
SB90T-4,0A 01509401	cm. 400x113,1x 90h				9.445,00 263 / 3,16
SB90T-4,4A 01509441	cm. 440x113,1x 90h				9.782,00 290 / 3,47



STRUTTURE SBALZO 1 LATO S90 AUTOPORTANTI

MOD. COD.	DESCRIZIONE/DESCRIPTION/BEZEICHNUNG/DESCRIPTION/DESCRIPCIÓN DIMENSIONI/DIMENSIONS/ABMESSUNGEN/DIMENSIONS/DIMENSIONES	POTENZA/POWER/LEISTUNG/PUISSANCE/POTENCIA VOLTAGGIO/VOLTAGE/SPANNUNG/VOLTAGE/VOLTAJE	$\frac{kW}{kcal/h}$ $\frac{V}{Hz}$	PREZZO/PRICE € PREIS/PRIX/PRECIO € KG / M ³
SB90T-4,8A 01509481	cm. 480x113,1x 90h			10.120,00 311 / 3,77
SB90T-5,2A 01509521	cm. 520x113,1x 90h			10.457,00 338 / 4,08
SB90T-5,6A 01509561	cm. 560x113,1x 90h			10.796,00 359 / 4,39
SB90T-6,0A 01509601	cm. 600x113,1x 90h			11.133,00 380 / 4,70
SB99T-2,8A 01599281	STRUTTURA SBALZO 2 LATI SERIE 90T, 2 piedi autoportanti EN CANTILEVER STRUCTURE 2 sides S90T, 2 self-supporting feet • DE BRÜCKENSTRUKTURE 2 seiten S90T, 2 stehern für selbsttragende Struktur • FR STRUCTURE SUSPENDUES 2 cotés S90T, 2 pieds autoportantes • ES ESTRUCTURA Suspendida 2 LADOS S90T, 2 PATAS AUTOPORTANTES cm. 280x 200x 90h			9.300,00 226 / 3,86
SB99T-3,2A 01599321	cm. 320x 200x 90h			9.751,00 257 / 4,39
SB99T-3,6A 01599361	cm. 360x 200x 90h			10.200,00 281 / 4,92
SB99T-4,0A 01599401	cm. 400x 200x 90h			10.648,00 305 / 5,45
SB99T-4,4A 01599441	cm. 440x 200x 90h			11.099,00 336 / 5,99
SB99T-4,8A 01599481	cm. 480x 200x 90h			11.544,00 360 / 6,52
SB99T-5,2A 01599521	cm. 520x 200x 90h			11.996,00 391 / 7,05
SB99T-5,6A 01599561	cm. 560x 200x 90h			12.446,00 415 / 7,58
SB99T-6,0A 01599601	cm. 600x 200x 90h			12.894,00 440 / 8,11
SB70T-2,8A 01507281	STRUTTURA SBALZO 1 LATO SERIE 70T, 2 piedi autoportanti EN CANTILEVER STRUCTURE 1 side S70T, 2 self-supporting feet • DE BRÜCKENSTRUKTURE 1 seite S70T, 2 stehern für selbsttragende Struktur • FR STRUCTURE SUSPENDUES 1 coté S70T, 2 pieds autoportantes • ES ESTRUCTURA Suspendida 1 LADO S70T, 2 PATAS AUTOPORTANTES cm. 280x 93,6x 90h			8.432,00 191 / 1,83
SB70T-3,2A 01507321	cm. 320x 93,6x 90h			8.769,00 217 / 2,08
SB70T-3,6A 01507361	cm. 360x 93,6x 90h			9.108,00 238 / 2,33
SB70T-4,0A 01507401	cm. 400x 93,6x 90h			9.445,00 259 / 2,58

STRUTTURE SBALZO 1 LATO S70 AUTOPORTANTI

MOD. COD.	DESCRIZIONE/DESCRIPTION/BEZEICHNUNG/DESCRIPTION/DESCRIPCIÓN DIMENSIONI/DIMENSIONS/ABMESSUNGEN/DIMENSIONS/DIMENSIONES	POTENZA/POWER/LEISTUNG/PUISSANCE/POTENCIA VOLTAGGIO/VOLTAGE/SPANNUNG/VOLTAGE/VOLTAJE	kw kcal/h	kw V- Hz	PREZZO/PRICE PREIS/PRIX/PRECIO €/KG / M ³
SB70T-4,4A 01507441	cm. 440x 93,6x 90h				9.782,00 285 / 2,84
SB70T-4,8A 01507481	cm. 480x 93,6x 90h				10.120,00 306 / 3,09
SB70T-5,2A 01507521	cm. 520x 93,6x 90h				10.457,00 332 / 3,34
SB70T-5,6A 01507561	cm. 560x 93,6x 90h				10.796,00 353 / 3,59
SB70T-6,0A 01507601	cm. 600x 93,6x 90h				11.133,00 374 / 3,84
SB77T-2,8A 01577281	STRUTTURA SBALZO 2 LATI SERIE 70T, 2 piedi autoportanti EN CANTILEVER STRUCTURE 2 sides S70T, 2 self-supporting feet • DE BRÜCKENSTRUKTURE 2 seiten S70T, 2 stehern für selbsttragende Struktur • FR STRUCTURE SUSPENDUES 2 cotés S70T, 2 pieds autoportantes • ES ESTRUCTURA SUSPENDIDA 2 LADOS S70T, 2 PATAS AUTOPORTANTES cm. 280x 161x 90h				9.300,00 218 / 3,05
SB77T-3,2A 01577321	cm. 320x 161x 90h				9.751,00 248 / 3,47
SB77T-3,6A 01577361	cm. 360x 161x 90h				10.200,00 272 / 3,89
SB77T-4,0A 01577401	cm. 400x 161x 90h				10.648,00 296 / 4,31
SB77T-4,4A 01577441	cm. 440x 161x 90h				11.099,00 326 / 4,73
SB77T-4,8A 01577481	cm. 480x 161x 90h				11.544,00 350 / 5,15
SB77T-5,2A 01577521	cm. 520x 161x 90h				11.996,00 380 / 5,57
SB77T-5,6A 01577561	cm. 560x 161x 90h				12.446,00 404 / 5,99
SB77T-6,0A 01577601	cm. 600x 161x 90h				12.894,00 428 / 6,41
SB79T-2,8A 01579281	STRUTTURA SBALZO 2 LATI SERIE 70T/90T, 2 piedi autoportanti EN CANTILEVER STRUCTURE 2 sides S70T/90T, 2 self-supporting feet • DE BRÜCKENSTRUKTURE 2 seiten S70T/90T, 2 stehern für selbsttragende Struktur • FR STRUCTURE SUSPENDUES 2 cotés S70T/90T, 2 pieds autoportantes • ES ESTRUCTURA SUSPENDIDA 2 LADOS S70T/90T, 2 PATAS AUTOPORTANTES cm. 280x180,5x 90h				9.300,00 222 / 3,45
SB79T-3,2A 01579321	cm. 320x180,5x 90h				9.751,00 253 / 3,93
SB79T-3,6A 01579361	cm. 360x180,5x 90h				10.200,00 277 / 4,40

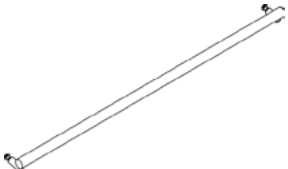
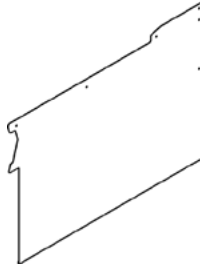
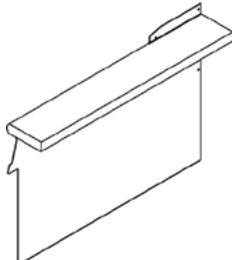

STRUTTURE SBALZO 2 LATI S90 E 70 AUTOPORTANTI

MOD. COD.	DESCRIZIONE/DESCRIPTION/BEZEICHNUNG/DESCRIPTION/DESCRIPCIÓN DIMENSIONI/DIMENSIONS/ABMESSUNGEN/DIMENSIONS/DIMENSIONES	POTENZA/POWER/LEISTUNG/PUISSANCE/POTENCIA VOLTAGGIO/VOLTAGE/SPANNUNG/VOLTAGE/VOLTAJE	kw kcal/h	kw V~ Hz	PREZZO/PRICE PREIS/PRIX/PRECIO €/KG / M ³
SB79T-4,0A 01579401	cm. 400x180,5x 90h				10.648,00 301 / 4,88
SB79T-4,4A 01579441	cm. 440x180,5x 90h				11.099,00 331 / 5,36
SB79T-4,8A 01579481	cm. 480x180,5x 90h				11.544,00 355 / 5,83
SB79T-5,2A 01579521	cm. 520x180,5x 90h				11.996,00 386 / 6,31
SB79T-5,6A 01579561	cm. 560x180,5x 90h				12.446,00 410 / 6,78
SB79T-6,0A 01579601	cm. 600x180,5x 90h				12.894,00 434 / 7,26
SOVMOB	SOVRAPPREZZO PER MONTAGGIO DI UN APPARECCHIO A MOBILE. ATTENZIONE: IN CASO DI MONTAGGIO SU STRUTTURE DA 2,0/2,4 mt., QUEST'ULTIME SARANNO PRODOTTE CON 2 PIEDI EN OVERPRICE FOR ASSEMBLY OF A STAND UNIT. ATTENTION: IN CASE OF MOUNTING OVER STRUCTURE FOR 2,0/2,4 mt, THE LATTER WILL BE PRODUCED WITH TWO FEET. • DE PREISERHÖRUNG FÜR DIE MONTAGE VON EINE STAND GERAT. ACHTUNG: FÜR DEN EINBAU AUF STRUKTUREN VON 2,0/2,4 Meter, WERDEN DIESE MIT 2 FUSSE GELIEFERT. • FR AUGMENTATION DE PRIX POUR L'ASSEMBLAGE D'UN APPAREIL SUR PLACARD. ATTENTION: EN CAS DE MONTAGE SUR STRUCTURES DE 2,0 ET 2,4 mt., CES STRUCTURES SERONT PRODUITE AVEC 2 PIEDS. • ES INCREMENTO DE PRECIOS POR LE MONTAJE DE UN APPARATO SOBRE UN MEUBLE. ATENCION: EN CASO DE MONTAJE SU ESTRUCTURAS DE MEDIDA 2,0M Y 2,4M, ESAS SERAN DE 2 PATAS				347,00 /
CORRIMANO	CORRIMANO EN HANDRAIL • DE HAND LAUF • FR MAIN COURANTE • ES PASAMANO €/m				427,00 /
SB90-FDX 01609000	TESTATA 1 LATO SERIE 90 DX EN Head 1 side S90 DX • DE Abschluss element 1 seite S90 DX • FR Element de jonction 1 coté S90 DX • ES EMBELLECEDOR 1 LADO S90 DX cm. 0,2x131,1x 90h				444,00 13.4 / 0,02
SB90-FPDX 01609010	TESTATA 1 LATO SERIE 90 DX CON PIANETTO EN Head 1 side S90 DX with shelf • DE Abschluss element 1 seite S90 DX mit ablage • FR Element de jonction 1 coté S90 DX avec etagere • ES EMBELLECEDOR 1 LADO S90 DX CON ESTANTE cm. 20x131,1x 90h				802,00 18.8 / 0,38

TESTATE 1 LATO S90

MOD. COD.	DESCRIZIONE/DESCRIPTION/BEZEICHNUNG/DESCRIPTION/DESCRIPCIÓN DIMENSIONI/DIMENSIONS/ABMESSUNGEN/DIMENSIONS/DIMENSIONES	POTENZA/POWER/LEISTUNG/PUISSANCE/POTENCIA VOLTAGGIO/VOLTAGE/SPANNUNG/VOLTAGE/VOLTAJE	⌀kW kcal/h	kw V~ Hz	PREZZO/PRICE PREIS/PRIX/PRECIO € KG / M³
SB90-FSX 01609001	TESTATA 1 LATO SERIE 90 SX EN Head 1 side S90 SX • DE Abschluss element 1 seite S90 SX • FR Element de jonction 1 coté S90 SX • ES EMBELLECEDOR 1 LADO S90 SX cm. 0,2x131,1x 90h				444,00 13.4 / 0,02
SB90-FPSX 01609011	TESTATA 1 LATO SERIE 90 SX CON PIANETTO EN Head 1 side S90 SX with shelf • DE Abschluss element 1 seite S90 SX mit ablage • FR Element de jonction 1 coté S90 SX avec etagere • ES EMBELLECEDOR 1 LADO S90 SX CON ESTANTE cm. 20x131,1x 90h				802,00 18.8 / 0,38
SB99-F 01699002	TESTATA 2 LATI SERIE 90 EN Head 2 sides S90 • DE Abschluss element seiten S90 • FR Element de jonction 2 cotés S90 • ES EMBELLECEDOR 2 LADOS S90 cm. 0,2x 200x 90h				664,00 23.7 / 0,04
SB99-FP 01699012	TESTATA 2 LATI SERIE 90 CON PIANETTO EN Head 2 sides S90 with shelf • DE Abschluss element seiten S90 mit ablage • FR Element de jonction 2 cotés S90 avec etagere • ES EMBELLECEDOR 2 LADOS S90 CON ESTANTE cm. 20x 200x 90h				1.071,00 33.3 / 0,66
SB90T-FDX 01709000	TESTATA 1 LATO SERIE 90TOP DX EN Head 1 side S90TOP DX • DE Abschluss element 1 seite S90TOP DX • FR Element de jonction 1 coté S90TOP DX • ES EMBELLECEDOR 1 LADO S90TOP DX cm. 0,2x131,1x 36h				305,00 5.1 / 0,01
SB90T-FPDX 01709010	TESTATA 1 LATO SERIE 90TOP DX CON PIANETTO EN Head 1 side S90TOP DX with shelf • DE Abschluss element 1 seite S90TOP DX mit ablage • FR Element de jonction 1 coté S90TOP DX avec etagere • ES EMBELLECEDOR 1 LADO S90TOP DX CON ESTANTE cm. 20x131,1x 36h				664,00 10.5 / 0,21

TESTATE 1 LATO S90

MOD. COD.	DESCRIZIONE/DESCRIPTION/BEZEICHNUNG/DESCRIPTION/DESCRIPCIÓN DIMENSIONI/DIMENSIONS/ABMESSUNGEN/DIMENSIONS/DIMENSIONES	POTENZA/POWER/LEISTUNG/PUISSANCE/POTENCIA VOLTAGGIO/VOLTAGE/SPANNUNG/VOLTAGE/VOLTAJE	kW kcal/h	kw V~ Hz	PREZZO/PRICE € PREIS/PRIX/PRECIO KG / M³
SB90T-FSX 01709001	TESTATA 1 LATO SERIE 90TOP SX EN Head 1 side S90TOP SX • DE Abschluss element 1 seite S90TOP SX • FR Element de jonction 1 coté S90TOP SX • ES EMBELLECEDOR 1 LADO S90TOP SX cm. 0,2x131,1x 36h				305,00 5.2 / 0,01
SB90T-FPSX 01709011	TESTATA 1 LATO SERIE 90TOP SX CON PIANETTO EN Head 1 side S90TOP SX with shelf • DE Abschluss element 1 seite S90TOP SX mit ablage • FR Element de jonction 1 coté S90TOP SX avec etagere • ES EMBELLECEDOR 1 LADO S90TOP SX CON ESTANTE cm. 20x131,1x 36h				664,00 10.7 / 0,21
SB99T-F 01799002	TESTATA 2 LATI SERIE 90TOP EN Head 2 sides S90TOP • DE Abschluss element seiten S90TOP • FR Element de jonction 2 cotés S90TOP • ES EMBELLECEDOR 2 LADOS S90TOP cm. 0,2x 200x 36h				407,00 9.3 / 0,02
SB99T-FP 01799012	TESTATA 2 LATI SERIE 90TOP CON PIANETTO EN Head 2 sides S90TOP with shelf • DE Abschluss element seiten S90TOP mit ablage • FR Element de jonction 2 cotés S90TOP avec etagere • ES EMBELLECEDOR 2 LADOS S90TOP CON ESTANTE cm. 20x 200x 36h				815,00 18.9 / 0,37
SB70-FDX 01607000	TESTATA 1 LATO SERIE 70 DX EN Head 1 side S70 DX • DE Abschluss element 1 seite S70 DX • FR Element de jonction 1 coté S70 DX • ES EMBELLECEDOR 1 LADO S70 DX cm. 0,2x 93,6x 90h				401,00 11 / 0,02
SB70-FPDX 01607010	TESTATA 1 LATO SERIE 70 DX CON PIANETTO EN Head 1 side S70 DX with shelf • DE Abschluss element 1 seite S70 DX mit ablage • FR Element de jonction 1 coté S70 DX avec etagere • ES EMBELLECEDOR 1 LADO S70 DX CON ESTANTE cm. 20x 93,6x 90h				745,00 15.5 / 0,32

TESTATE 1 LATO S70

MOD. COD.	DESCRIZIONE/DESCRIPTION/BEZEICHNUNG/DESCRIPTION/DESCRIPCIÓN DIMENSIONI/DIMENSIONS/ABMESSUNGEN/DIMENSIONS/DIMENSIONES	POTENZA/POWER/LEISTUNG/PUISSANCE/POTENCIA VOLTAGGIO/VOLTAGE/SPANNUNG/VOLTAGE/VOLTAJE	⚡kW kcal/h	⚡kw V~ Hz	PREZZO/PRICE PREIS/PRIX/PRECIO € KG / M³
SB70-FSX 01607001	TESTATA 1 LATO SERIE 70 SX EN Head 1 side S70 SX • DE Abschluss element 1 seite S70 SX • FR Element de jonction 1 coté S70 SX • ES EMBELLECEDOR 1 LADO S70 SX cm. 0,2x 93,6x 90h				401,00 11 / 0,02
SB70-FPSX 01607011	TESTATA 1 LATO SERIE 70 SX CON PIANETTO EN Head 1 side S70 SX with shelf • DE Abschluss element 1 seite S70 SX mit ablage • FR Element de jonction 1 coté S70 SX avec etagere • ES EMBELLECEDOR 1 LADO S70 SX CON ESTANTE cm. 20x 93,6x 90h				745,00 15.5 / 0,32
SB77-F 01677002	TESTATA 2 LATI SERIE 70 EN Head 2 sides S70 • DE Abschluss element seiten S70 • FR Element de jonction 2 cotés S70 • ES EMBELLECEDOR 2 LADOS S70 cm. 0,2x 161x 90h				562,00 18.9 / 0,04
SB77-FP 01677012	TESTATA 2 LATI SERIE 70 CON PIANETTO EN Head 2 sides S70 with shelf • DE Abschluss element seiten S70 mit ablage • FR Element de jonction 2 cotés S70 avec etagere • ES EMBELLECEDOR 2 LADOS S70 CON ESTANTE cm. 20x 161x 90h				945,00 26.6 / 0,54
SB70T-FDX 01707000	TESTATA 1 LATO SERIE 70TOP DX EN Head 1 side S70TOP DX • DE Abschluss element 1 seite S70TOP DX • FR Element de jonction 1 coté S70TOP DX • ES EMBELLECEDOR 1 LADO S70TOP DX cm. 0,2x 93,6x 36h				283,00 4.2 / 0,01
SB70T-FPDX 01707010	TESTATA 1 LATO SERIE 70TOP DX CON PIANETTO EN Head 1 side S70TOP DX with shelf • DE Abschluss element 1 seite S70TOP DX mit ablage • FR Element de jonction 1 coté S70TOP DX avec etagere • ES EMBELLECEDOR 1 LADO S70TOP DX CON ESTANTE cm. 20x 93,6x 36h				624,00 8.6 / 0,18

TESTATE 1 LATO S70

MOD. COD.	DESCRIZIONE/DESCRIPTION/BEZEICHNUNG/DESCRIPTION/DESCRIPCIÓN DIMENSIONI/DIMENSIONS/ABMESSUNGEN/DIMENSIONS/DIMENSIONES	POTENZA/POWER/LEISTUNG/PUISSANCE/POTENCIA VOLTAGGIO/VOLTAGE/SPANNUNG/VOLTAGE/VOLTAJE	kw kcal/h	kw V~ Hz	PREZZO/PRICE € PREIS/PRIX/PRECIO KG / M³
SB70T-FSX 01707001	TESTATA 1 LATO SERIE 70TOP SX EN Head 1 side S70TOP SX • DE Abschluss element 1 seite S70TOP SX • FR Element de jonction 1 coté S70TOP SX • ES EMBELLECEDOR 1 LADO S70TOP SX cm. 0,2x 93,6x 36h				283,00 4.3 / 0,01
SB70T-FPSX 01707011	TESTATA 1 LATO SERIE 70TOP SX CON PIANETTO EN Head 1 side S70TOP SX with shelf • DE Abschluss element 1 seite S70TOP SX mit ablage • FR Element de jonction 1 coté S70TOP SX avec etagere • ES EMBELLECEDOR 1 LADO S70TOP SX CON ESTANTE cm. 20x 93,6x 36h				624,00 8.8 / 0,18
SB77T-F 01777002	TESTATA 2 LATI SERIE 70TOP EN Head 2 sides S70TOP • DE Abschluss element seiten S70TOP • FR Element de jonction 2 cotés S70TOP • ES EMBELLECEDOR 2 LADOS S70TOP cm. 0,2x 161x 36h				355,00 7.4 / 0,02
SB77T-FP 01777012	TESTATA 2 LATI SERIE 70TOP CON PIANETTO EN Head 2 sides S70TOP with shelf • DE Abschluss element seiten S70TOP mit ablage • FR Element de jonction 2 cotés S70TOP avec etagere • ES EMBELLECEDOR 2 LADOS S70TOP CON ESTANTE cm. 20x 161x 36h				740,00 15.1 / 0,30
SB79-FDX 01679000	TESTATA 2 LATI SERIE 70/90 DX EN Head 2 sides S70/S90 DX • DE Abschluss element seiten S70/S90 DX • FR Element de jonction 2 cotés S70/S90 DX • ES EMBELLECEDOR 2 LADOS S70/S90 DX cm. 0,2x180,5x 90h				612,00 21.3 / 0,04
SB79-FPDX 01679010	TESTATA 2 LATI SERIE 70/90 DX CON PIANETTO EN Head 2 sides S70/S90 DX with shelf • DE Abschluss element seiten S70/S90 DX mit ablage • FR Element de jonction 2 cotés S70/S90 DX avec etagere • ES EMBELLECEDOR 2 LADOS S70/S90 DX CON ESTANTE cm. 20x180,5x 90h				1.004,00 30 / 0,60

TESTATA 2 LATI S90 E 70

MOD. _____
COD. _____

DESCRIZIONE/DESCRIPTION/BEZEICHNUNG/DESCRIPTION/DESCRIPCIÓN
DIMENSIONI/DIMENSIONS/ABMESSUNGEN/DIMENSIONS/DIMENSIONES

POTENZA/POWER/LEISTUNG/PUISSANCE/POTENCIA
VOLTAGGIO/VOLTAGE/SPANNUNG/VOLTAGE/VOLTAJE

⚡kw kcal/h ⚡kw V~ Hz

PREZZO/PRICE €
PREIS/PRIX/PRECIO €
KG / M³

SB79-FSX TESTATA 2 LATI SERIE 70/90 SX
01679001 **EN** Head 2 sides S70/S90 SX • **DE** Abschluss element seiten S70/S90 SX • **FR** Element de jonction 2 cotés S70/S90 SX • **ES** **EMBELLECEDOR 2 LADOS S70/S90 SX**
cm. 0,2x180,5x 90h

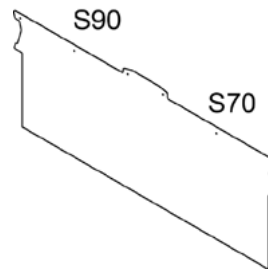

612,00
21.3 / 0,04

SB79-FPSX TESTATA 2 LATI SERIE 70/90 SX CON PIANETTO
01679011 **EN** Head 2 sides S70/S90 SX with shelf • **DE** Abschluss element seiten S70/S90 SX mit ablage • **FR** Element de jonction 2 cotés S70/S90 SX avec etagere • **ES** **EMBELLECEDOR 2 LADOS S70/S90 SX CON ESTANTE**
cm. 20x180,5x 90h

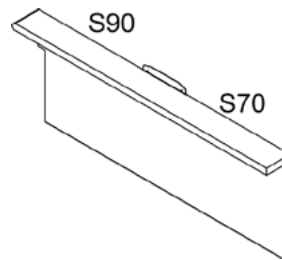

1.004,00
30 / 0,60

SB79T-FDX TESTATA 2 LATI SERIE 70TOP/90TOP DX
01779000 **EN** Head 2 sides S70TOP/S90TOP DX • **DE** Abschluss element seiten S70TOP/S90TOP DX • **FR** Element de jonction 2 cotés S70TOP/S90TOP DX • **ES** **EMBELLECEDOR 2 LADOS S70TOP/S90TOP DX**
cm. 0,2x180,5x 36h

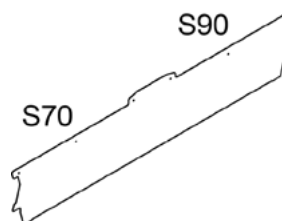

382,00
8.4 / 0,02

SB79T-FPDX TESTATA 2 LATI SERIE 70TOP/90TOP DX CON PIANETTO
01779010 **EN** Head 2 sides S70TOP/S90TOP DX with shelf • **DE** Abschluss element seiten S70TOP/S90TOP DX mit ablage • **FR** Element de jonction 2 cotés S70TOP/S90TOP DX avec etagere • **ES** **EMBELLECEDOR 2 LADOS S70TOP/S90TOP DX CON ESTANTE**
cm. 20x180,5x 36h

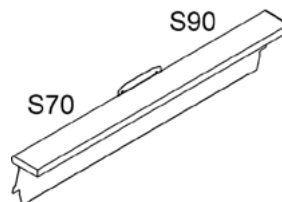

777,00
17 / 0,33

SB79T-FSX TESTATA 2 LATI SERIE 70TOP/90TOP SX
01779001 **EN** Head 2 sides S70TOP/S90TOP SX • **DE** Abschluss element seiten S70TOP/S90TOP SX • **FR** Element de jonction 2 cotés S70TOP/S90TOP SX • **ES** **EMBELLECEDOR 2 LADOS S70TOP/S90TOP SX**
cm. 0,2x180,5x 36h

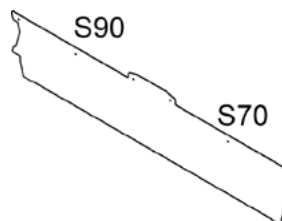

382,00
8.4 / 0,02

SB79T-FPSX TESTATA 2 LATI SERIE 70TOP/90TOP SX CON PIANETTO
01779011 **EN** Head 2 sides S70TOP/S90TOP SX with shelf • **DE** Abschluss element seiten S70TOP/S90TOP SX mit ablage • **FR** Element de jonction 2 cotés S70TOP/S90TOP SX avec etagere • **ES** **EMBELLECEDOR 2 LADOS S70TOP/S90TOP SX CON ESTANTE**
cm. 20x180,5x 36h

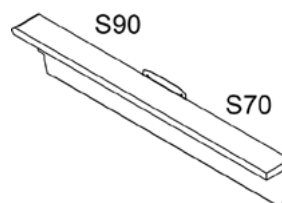

777,00
17 / 0,33

SB99TM-FDX TESTATA 2 LATI SERIE 90TOP/90 DX
01899000 **EN** Head 2 sides S90TOP/S90 DX • **DE** Abschluss element seiten S90TOP/S90 DX • **FR** Element de jonction 2 cotés S90TOP/S90 DX • **ES** **EMBELLECEDOR 2 LADOS S90TOP/S90 DX**
cm. 0,2x 200x 90h

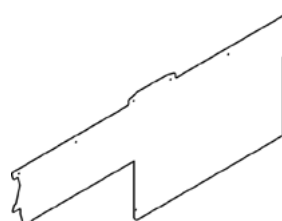

550,00
17.3 / 0,04

TESTATE 2 LATI S90 E 70

MOD. COD.	DESCRIZIONE/DESCRIPTION/BEZEICHNUNG/DESCRIPTION/DESCRIPCIÓN DIMENSIONI/DIMENSIONS/ABMESSUNGEN/DIMENSIONS/DIMENSIONES	POTENZA/POWER/LEISTUNG/PUISSANCE/POTENCIA VOLTAGGIO/VOLTAGE/SPANNUNG/VOLTAGE/VOLTAJE	kW kcal/h	kw V~ Hz	PREZZO/PRICE € PREIS/PRIX/PRECIO KG / M³
SB99TM-FPDX 01899010	TESTATA 2 LATI SERIE 90TOP/90 DX CON PIANETTO EN Head 2 sides S90TOP/S90 DX with shelf • DE Abschluss element seiten S90TOP/S90 DX mit ablage • FR Element de jonction 2 cotés S90TOP/S90 DX avec etagere • ES EMBELLECEDOR 2 LADOS S90TOP/S90 DX CON ESTANTE cm. 20x 200x 90h				963,00 26.9 / 0,66
SB99TM-FSX 01899001	TESTATA 2 LATI SERIE 90TOP/90 SX EN Head 2 sides S90TOP/S90 SX • DE Abschluss element seiten S90TOP/S90 SX • FR Element de jonction 2 cotés S90TOP/S90 SX • ES EMBELLECEDOR 2 LADOS S90TOP/S90 SX cm. 0,2x 200x 90h				550,00 17.3 / 0,04
SB99TM-FPSX 01899011	TESTATA 2 LATI SERIE 90TOP/90 SX CON PIANETTO EN Head 2 sides S90TOP/S90 SX with shelf • DE Abschluss element seiten S90TOP/S90 SX mit ablage • FR Element de jonction 2 cotés S90TOP/S90 SX avec etagere • ES EMBELLECEDOR 2 LADOS S90TOP/S90 SX CON ESTANTE cm. 20x 200x 90h				963,00 26.9 / 0,66
SB77TM-FDX 01877000	TESTATA 2 LATI SERIE 70TOP/70 DX EN Head 2 sides S70TOP/S70 DX • DE Abschluss element seiten S70TOP/S70 DX • FR Element de jonction 2 cotés S70TOP/S70 DX • ES EMBELLECEDOR 2 LADOS S70TOP/S70 DX cm. 0,2x 161x 36h				478,00 13.8 / 0,04
SB77TM-FPDX 01877010	TESTATA 2 LATI SERIE 70TOP/70 DX CON PIANETTO EN Head 2 sides S70TOP/S70 DX with shelf • DE Abschluss element seiten S70TOP/S70 DX mit ablage • FR Element de jonction 2 cotés S70TOP/S70 DX avec etagere • ES EMBELLECEDOR 2 LADOS S70TOP/S70 DX CON ESTANTE cm. 20x 161x 36h				860,00 21.5 / 0,54
SB77TM-FSX 01877001	TESTATA 2 LATI SERIE 70TOP/70 SX EN Head 2 sides S70TOP/S70 SX • DE Abschluss element seiten S70TOP/S70 SX • FR Element de jonction 2 cotés S70TOP/S70 SX • ES EMBELLECEDOR 2 LADOS S70TOP/S70 SX cm. 0,2x 161x 36h				478,00 13.8 / 0,04
SB77TM-FPSX 01877011	TESTATA 2 LATI SERIE 70TOP/70 SX CON PIANETTO EN Head 2 sides S70TOP/S70 SX with shelf • DE Abschluss element seiten S70TOP/S70 SX mit ablage • FR Element de jonction 2 cotés S70TOP/S70 SX avec etagere • ES EMBELLECEDOR 2 LADOS S70TOP/S70 SX CON ESTANTE cm. 20x 161x 36h				860,00 21.5 / 0,54

TESTATE 2 LATI S90 E 70

MOD. COD.	DESCRIZIONE/DESCRIPTION/BEZEICHNUNG/DESCRIPTION/DESCRIPCIÓN DIMENSIONI/DIMENSIONS/ABMESSUNGEN/DIMENSIONS/DIMENSIONES	POTENZA/POWER/LEISTUNG/PUISSANCE/POTENCIA VOLTAGGIO/VOLTAGE/SPANNUNG/VOLTAGE/VOLTAJE	⚡kW kcal/h	⚡kW V~ Hz	PREZZO/PRICE € PREIS/PRIX/PRECIO € KG / M³
SB79TM-FDX 01879000	TESTATA 2 LATI SERIE 70TOP/90 DX EN Head 2 sides S70TOP/S90 DX • DE Abschluss element seiten S70TOP/S90 DX • FR Element de jonction 2 cotés S70TOP/S90 DX • ES EMBELLECEDOR 2 LADOS S70TOP/S90 DX cm. 0,2x180,5x 90h				540,00 15.6 / 0,04
SB79TM-FPDx 01879010	TESTATA 2 LATI SERIE 70TOP/90 DX CON PIANETTO EN Head 2 sides S70TOP/S90 DX with shelf • DE Abschluss element seiten S70TOP/S90 DX mit ablage • FR Element de jonction 2 cotés S70TOP/S90 DX avec etagere • ES EMBELLECEDOR 2 LADOS S70TOP/S90 DX CON ESTANTE cm. 20x180,5x 90h				949,00 24.2 / 0,60
SB79TM-FSX 01879001	TESTATA 2 LATI SERIE 70TOP/90 SX EN Head 2 sides S70TOP/S90 SX • DE Abschluss element seiten S70TOP/S90 SX • FR Element de jonction 2 cotés S70TOP/S90 SX • ES EMBELLECEDOR 2 LADOS S70TOP/S90 SX cm. 0,2x180,5x 90h				540,00 15.6 / 0,04
SB79TM-FPSX 01879011	TESTATA 2 LATI SERIE 70TOP/90 SX CON PIANETTO EN Head 2 sides S70TOP/S90 SX with shelf • DE Abschluss element seiten S70TOP/S90 SX mit ablage • FR Element de jonction 2 cotés S70TOP/S90 SX avec etagere • ES EMBELLECEDOR 2 LADOS S70TOP/S90 SX CON ESTANTE cm. 20x180,5x 90h				949,00 24.2 / 0,60
SB97TM-FDX 01897000	TESTATA 2 LATI SERIE 90TOP/70 DX EN Head 2 sides S90TOP/S70 DX • DE Abschluss element seiten S90TOP/S70 DX • FR Element de jonction 2 cotés S90TOP/S70 DX • ES EMBELLECEDOR 2 LADOS S90TOP/S70 DX cm. 0,2x180,5x 90h				468,00 14.4 / 0,04
SB97TM-FPDx 01897010	TESTATA 2 LATI SERIE 90TOP/70 DX CON PIANETTO EN Head 2 sides S90TOP/S70 DX with shelf • DE Abschluss element seiten S90TOP/S70 DX mit ablage • FR Element de jonction 2 cotés S90TOP/S70 DX avec etagere • ES EMBELLECEDOR 2 LADOS S90TOP/S70 DX CON ESTANTE cm. 20x180,5x 90h				851,00 23 / 0,60

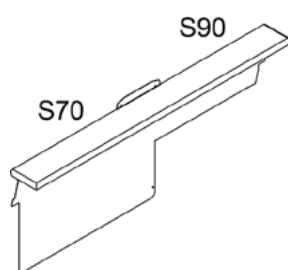
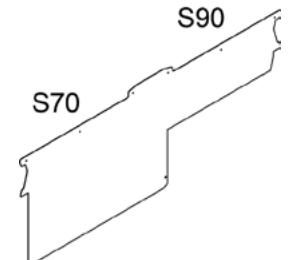
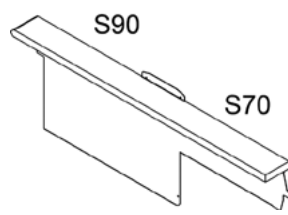
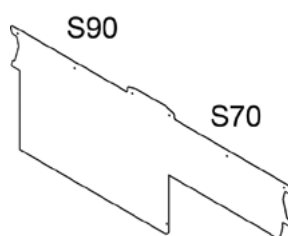
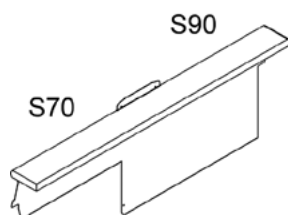
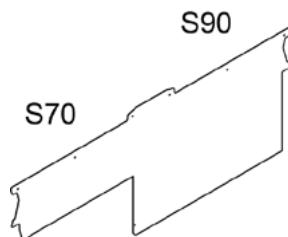

TESTATE 2 LATI S90 E 70

MOD. COD.	DESCRIZIONE/DESCRIPTION/BEZEICHNUNG/DESCRIPTION/DESCRIPCIÓN DIMENSIONI/DIMENSIONS/ABMESSUNGEN/DIMENSIONS/DIMENSIONES	POTENZA/POWER/LEISTUNG/PUISSANCE/POTENCIA VOLTAGGIO/VOLTAGE/SPANNUNG/VOLTAGE/VOLTAJE	$\frac{kW}{kcal/h}$ $\frac{kw}{V\sim}$ Hz	PREZZO/PRICE € PREIS/PRIX/PRECIO KG / M ³
---------------------	---	---	--	---

SB97TM-FSX TESTATA 2 LATI SERIE 90TOP/70 SX
01897001 **EN** Head 2 sides S90TOP/S70 SX • **DE** Abschluss element seiten S90TOP/S70 SX • **FR** Element de jonction 2 cotés S90TOP/S70 SX • **ES EMBELLECEDOR 2 LADOS S90TOP/S70 SX**
cm. **0,2x180,5x 90h**

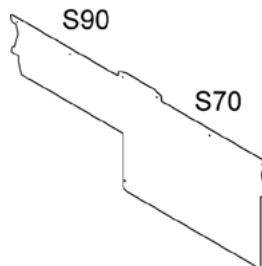

468,00
14.4 / 0,04

SB97TM-FPSX TESTATA 2 LATI SERIE 90TOP/70 SX CON PIANETTO
01897011 **EN** Head 2 sides S90TOP/S70 SX with shelf • **DE** Abschluss element seiten S90TOP/S70 SX mit ablage • **FR** Element de jonction 2 cotés S90TOP/S70 SX avec etagere • **ES EMBELLECEDOR 2 LADOS S90TOP/S70 SX CON ESTANTE**
cm. **20x180,5x 90h**

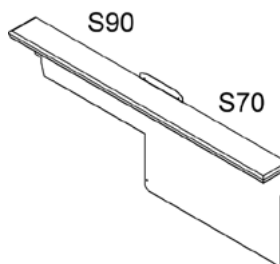

851,00
23 / 0,60

Infografía - Infographic

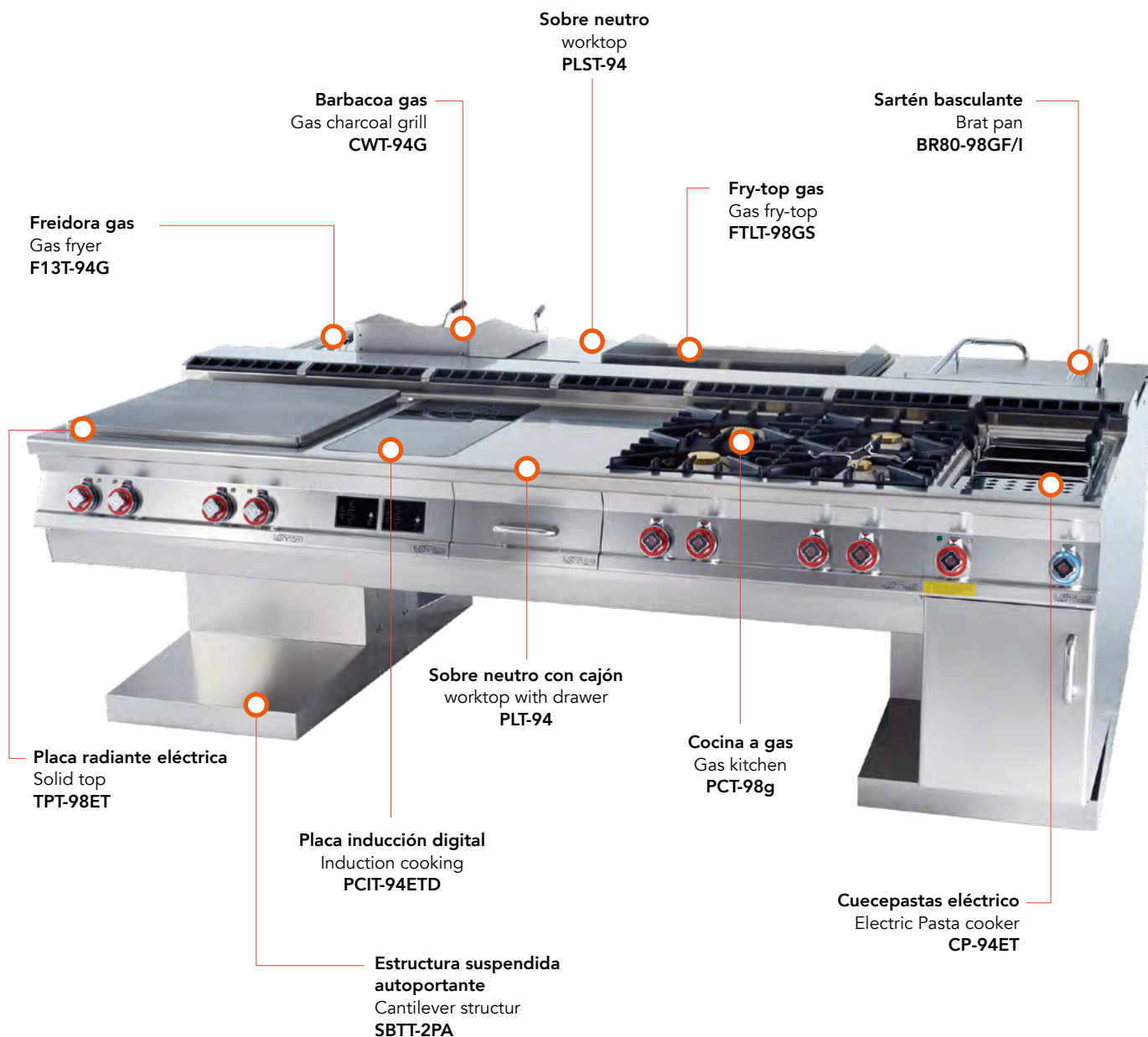

PRODUCTOS SNACK

LOTUS®

SALAMANDRE

MOD. _____
COD. _____

DESCRIZIONE/DESCRIPTION/BEZEICHNUNG/DESCRIPTION/DESCRIPCIÓN
DIMENSIONI/DIMENSIONS/ABMESSUNGEN/DIMENSIONS/DIMENSIONES

POTENZA/POWER/LEISTUNG/PUISSANCE/POTENCIA
VOLTAGGIO/VOLTAGE/SPANNUNG/VOLTAGE/VOLTAJE

⚡ kW _____
kcal/h _____
V~ _____
Hz _____

PREZZO/PRICE € _____
PREIS/PRIX/PRECIO _____
KG / M³ _____

SA-400 EM SALAMANDRA Aperta sul fronte, 1 zona di cottura, 1 griglia cm.
20016510 35x32,5 - 1 teglia GN 2/3 h 20
EN Salamander - Open on the front side, 1 cooking area 1 grid 35x32,5
- 1 GN 2/3 h 20 pan • **DE** Salamander - Vorne offen, 1 Kochfläche
1 Rost cm. 35x32,5 - 1 Backform GN 2/3 h 20 • **FR** Salamandre -
Avant ouverte - 1 zone de cuisson 1 grille cm 35x32,5 - 1 bac GN 2/3
h 20 • **ES SALAMANDRA - ABIERTA DELANTE, 1 ZONA DE
COCCIÓN 1 PARRILLA CM. 35X32,5 - 1 BANDEJA GN 2/3
H. 20**
cm. 51x 40x 36,5h



⚡ 2 kW _____ **875,00**
230V~ _____ 17 / 0,13
50/60 Hz _____

SE-40 M SALAMANDRA Aperta sul fronte, con griglia mobile GN 2/3
20016511 **EN** Salamander - Open on the front side, with adjustable grid GN
2/3 • **DE** Salamander - Vorne offen, mit höhenverstellbarem Rost GN
2/3 • **FR** Salamandre - Avant ouverte, avec une grille réglable GN
2/3 • **ES SALAMANDRA - ABIERTA DELANTE, Y PARRILLA
REGULABLE GN 2/3**
cm. 59,5x 37x 38h



⚡ 2,2 kW _____ **692,00**
230V~ _____ 19 / 0,15
50/60 Hz _____

SA-600 EM SALAMANDRA Aperta sul fronte, 2 zone di cottura, 1 griglia cm.
20016610 53x32,5 - 1 teglia GN 1/1 h 20
EN Salamander - Open on the front side, 2 cooking areas 1 grid
53x32,5 - 1 GN 1/1 h 20 pan • **DE** Salamander - Vorne offen, 2
Kochflächen 1 Rost cm. 53x32,5 - 1 Backform GN 1/1 h 20 • **FR**
Salamandre - Avant ouverte - 2 zones de cuisson 1 grille cm 53x32,5 - 1
bac GN 1/1 h 20 • **ES SALAMANDRA - ABIERTA DELANTE,
2 ZONAS DE COCCIÓN 1 PARRILLA CM. 53X32,5 - 1
BANDEJA GN 1/1 H. 20**
cm. 69x 40x 36,5h



⚡ 4 kW _____ **1.131,00**
230V~ _____ 28 / 0,17
50/60 Hz _____

SA-600 ET **cm. 69x 40x 36,5h**
20016630

⚡ 4 kW _____ **1.196,00**
400V~2N _____ 28 / 0,17
230V~3 _____
50/60 Hz _____

SE-70 M SALAMANDRA Aperta sul fronte, con griglia mobile GN 1/1
20016631 **EN** Salamander - Open on the front side, with adjustable grid GN
1/1 • **DE** Salamander - Vorne offen, mit höhenverstellbarem Rost GN
1/1 • **FR** Salamandre - Avant ouverte, avec une grille réglable GN
1/1 • **ES SALAMANDRA - ABIERTA DELANTE, Y PARRILLA
REGULABLE GN 1/1**
cm. 87,5x 37x 38h



⚡ 4,4 kW _____ **958,00**
400V~3N _____ 50 / 0,22
50/60 Hz _____

SL-600 EM SALAMANDRA - Parte superiore regolabile Aperta su 3 lati - 2 zone di
20016810 cottura - 1 griglia cm. 58x34
EN Salamander - Upper part adjustable - 3 open sides 2 cooking areas
- 1 grid 58x34 • **DE** Salamander - Oberteil einstellbar - 3 offene Seite
2 Kochflächen - 1 Rost cm. 58x34 • **FR** Salamandre - Partie supérieure
réglable - 3 côtés ouverts 2 zones de cuisson - 1 grille cm 58x34 • **ES
SALAMANDRA - PARTE SUPERIOR REGULABLE - ABIERTA 3
LADOS 2 ZONAS DE COCCIÓN - 1 PARRILLA CM. 58X34**
cm. 60x 50x 51h



⚡ 4 kW _____ **2.104,00**
230V~ _____ 47 / 0,23
50/60 Hz _____

SL-600 ET **cm. 60x 50x 51h**
20016830

⚡ 4 kW _____ **2.187,00**
400V~2N _____ 47 / 0,23
230V~3 _____
50/60 Hz _____

SALAMANDRE

MOD. _____ DESCRIZIONE/DESCRIPTION/BEZEICHNUNG/DESCRIPTION/DESCRIPCIÓN POTENZA/POWER/LEISTUNG/PUISSANCE/POTENCIA kW kcal/h $\frac{kW}{V}$ PREZZO/PRICE €
 COD. _____ DIMENSIONI/DIMENSIONS/ABMESSUNGEN/DIMENSIONS/DIMENSIONES VOLTAGGIO/VOLTAGE/SPANNUNG/VOLTAGE/VOLTAJE $\frac{V}{Hz}$ PREIS/PRIX/PRECIO €
 KG / M³

SLC-600EM SALAMANDRA VETROCERAMICA - Parte superiore regolabile Aperta su
 20016811 3 lati - 2 zone di cottura - 1 griglia cm. 58x34
EN Ceramic glass Salamander - Upper part adjustable - 3 open sides
 2 cooking areas - 1 grid 58x34 • **DE** Ceran-Salamander - Oberteil
 einstellbar - 3 offene Seite 2 Kochflächen - 1 Rost cm. 58x34 • **FR**
 Salamandre à vitroceramique - Partie supérieure réglable - 3 côtés
 ouverts 2 zones de cuisson - 1 grille cm 58x34 • **ES SALAMANDRA**
VITROCERÁMICA - PARTE SUPERIOR REGULABLE - ABIERTA
3 LADOS 2 ZONAS DE COCCIÓN - 1 PARRILLA CM. 58X34
cm. 60x 50x 51h



3 kW **2.611,00**
 230V~ 50 / 0,23
 50/60 Hz

SLC-600ET cm. 60x 50x 51h
 20016831

3 kW **2.642,00**
 400V~2N 50 / 0,23
 230V~3
 50/60 Hz

SEH003 SALAMANDRA ULTRA RAPIDA GN1/1, Piano superiore regolabile in
 _SEH003 altezza. 3 Resistenze alto rendimento attivabili a zone: 1 centrale (1,55
 KW) o 3 totali (4,6 KW). Timer 20'.
EN Ultra-rapid electric Salamander GN1/1, Upper part adjustable. 3
 high-performanc heating elements with possibility activating: 1 central
 (1,55 KW) or 3 total (4,6 KW). Timer 20'. • **DE** Elektrische Salamander
 Ultra Rapid GN1/1, mit höhenverstellbarer Haube. 3 Hochleistungsfähige
 Heizelemente mit Selektion der Heizzone: 1 in der Mitte (1,55 KW) or
 3 alle (4,6 KW). Timer 20'. • **FR** Salamandra électrique Ultra-rapide
 GN1/1, avec plan mobile. 3 Résistances électriques à rendement élevé
 avec possibilité d'active: 1 central (1,55 KW) or 3 total (4,6 KW).
 Timer 20'. • **ES SALAMANDRA ELÉCTRICA ULTRA-RÁPIDA**
GN1/1, TECHO SUPERIOR REGULABLE EN ALTURA. 3
RESISTENCIAS DE ALTO RENDIMIENTOS CON POSIBILIDAD
DE ACTIVACIÓN: 1 CENTRAL (1,55 KW) OR 3 TOTAL (4,6
KW). TIMER 20'.
cm. 60x 60x 54h



4,6 kW **3.931,00**
 400V~3N 55 / 0,30
 230V~3
 230V~
 50/60 Hz

SEH004 SALAMANDRA ULTRA RAPIDA GN1/1 + GN1/3. Piano superiore
 _SEH004 regolabile in altezza. 4 Resistenze alto rendimento attivabili a zone: 2
 centrali (3,05 KW) o 4 totali (6,1 KW). Timer 20
EN Ultra-rapid electric Salamander GN1/1+GN1/3, Upper part
 adjustable. 4 high-performanc heating elements with possibility activating:
 2 central (3,05 KW) or 4 total (6,1 KW). Timer 20'. • **DE** Elektrische
 Salamander Ultra Rapid GN1/1+GN1/3, mit höhenverstellbarer Haube.
 4 Hochleistungsfähige Heizelemente mit Selektion der Heizzone: 2 in
 der Mitte (3,05 KW) or 4 alle (6,1 KW). Timer 20'. • **FR** Salamandra
 électrique Ultra-rapide GN1/1+GN1/3, avec plan mobile. 4 Résistances
 électriques à rendement élevé avec possibilité d'active: 2 central
 (3,05 KW) or 4 total (6,1 KW). Timer 20'. • **ES SALAMANDRA**
ELÉCTRICA ULTRA-RÁPIDA GN1/1+GN1/3, TECHO
SUPERIOR REGULABLE EN ALTURA. 4 RESISTENCIAS DE
ALTO RENDIMIENTOS CON POSIBILIDAD DE ACTIVACIÓN: 2
CENTRAL (3,05 KW) OR 4 TOTAL (6,1 KW). TIMER 20'.
cm. 77x 60x 54h

6,1 kW **4.655,00**
 400V~3N 65 / 0,40
 230V~3
 50/60 Hz

TS-3 TOSTIERA MONOFASE con 3 pinze
 20030310 **EN** Toaster singlephase with 3 toast holders • **DE** Toaster einphasig mit 3
 Zangen • **FR** Toasteur monophasé avec 3 pinces • **ES TOSTADORA**
MONOFÁSICA CON 3 PINZAS
cm. 48x 25x 24h



1,7 kW **460,00**
 230V~ 7 / 0,05
 50/60 Hz

GRILL TOAST

MOD. _____
COD. _____

DESCRIZIONE/DESCRIPTION/BEZEICHNUNG/DESCRIPTION/DESCRIPCIÓN
DIMENSIONI/DIMENSIONS/ABMESSUNGEN/DIMENSIONS/DIMENSIONES

POTENZA/POWER/LEISTUNG/PUISSANCE/POTENCIA
VOLTAGGIO/VOLTAGE/SPANNUNG/VOLTAGE/VOLTAJE

⚡ kW _____
kcal/h _____
V~ _____
Hz _____

PREZZO/PRICE €
PREIS/PRIX/PRECIO €
KG / M³

TS-6
20030610
TOSTIERA MONOFASE con 6 pinze
EN Toaster singlephase with 6 toast holders • **DE** Toaster einphasig mit 6 Zangen • **FR** Toasteur monophasé avec 6 pinces • **ES TOSTADORA MONOFÁSICA CON 6 PINZAS**
cm. **48x 25x 36h**



⚡ 2,55 kW _____ **646,00**
230V~ _____ 10 / 0,07
50/60 Hz _____

CT4/R EM
20040410
GRILL TOAST - Piastra rigate in ghisa cm. 34x23
EN Grill toast - Grooved plate cm. 34x23 • **DE** Kontakt-Grill - Gerillte Platte aus Gußeisen cm. 34x23 • **FR** Grill toast - Plaque rainurées cm. 34x23 • **ES GRILL-TOAST - PLANCHA ESTRIADA DE FUNDICIÓN 34X23 CM**
cm. **42x 36x 20h**



⚡ 2,2 kW _____ **850,00**
230V~ _____ 19 / 0,07
50/60 Hz _____

CT8/R EM
20040810
GRILL TOAST DOPPIO - Piastra rigate in ghisa cm. 48x23
EN Double Grill toast - Grooved plate cm. 48x23 • **DE** Kontakt-Grill - Gerillte Platte aus Gußeisen cm. 48x23 • **FR** Double grill toast - Plaque rainurées cm. 48x23 • **ES GRILL-TOAST DOBLE - PLANCHA ESTRIADA DE FUNDICIÓN 48X23 CM**
cm. **57x 36x 20h**



⚡ 3,6 kW _____ **1.182,00**
230V~ _____ 34 / 0,09
50/60 Hz _____

CT8/R ET
20040830
cm. **57x 36x 20h**

⚡ 3,6 kW _____ **1.182,00**
400V~2N _____ 34 / 0,09
50/60 Hz _____

PI35
_17PI001
PIASTRA INDUZIONE Ø225mm
EN Induction plate Ø225mm • **DE** Induktionsplatte Ø225mm • **FR** Plaque à induction Ø225mm • **ES PLACA INDUCCIÓN Ø225MM**
cm. **33x 41x 10h**



⚡ 3,5 kW _____ **517,00**
230V~ _____ 15 / 0,03
50/60 Hz _____

SP-5
20050510
SCALDAPLATI - 5 piatti
EN Hot plates set - 5 plates • **DE** Platten-Tellervorwärmer - 5 platten • **FR** Chauffe-plates - 5 plates • **ES CALIENTA PLATOS - 5 PLATOS**
cm. **37x 25x 32h**



⚡ 0,7 kW _____ **781,00**
230V~ _____ 19 / 0,07
50/60 Hz _____

SP-10
20051010
SCALDAPLATI - 10 piatti
EN Hot plates set - 10 plates • **DE** Platten-Tellervorwärmer - 10 platten • **FR** Chauffe-plates - 10 plates • **ES CALIENTA PLATOS - 10 PLATOS**
cm. **37x 25x 53h**

⚡ 1,4 kW _____ **1.326,00**
230V~ _____ 34 / 0,14
50/60 Hz _____

VEC-10
50158011
VETRINA RISCALDATA - 1 PIANO
EN Heated display units - 1 shelf • **DE** Heisse-Vitrine - 1 Etage • **FR** Vitrine chaude - 1 etage • **ES VITRINA CALEFACTORA INDIVIDUAL**
cm. **50x 35x 27h**





⚡ 0,4 kW _____ **626,00**
230V~ _____ 11 / 0,07
50/60 Hz _____

VEC-81
50158021
cm. **80x 35x 27h**

⚡ 0,7 kW _____ **798,00**
230V~ _____ 15 / 0,08
50/60 Hz _____

VETRINETTE CALDE

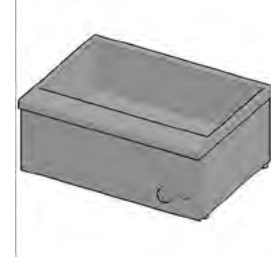
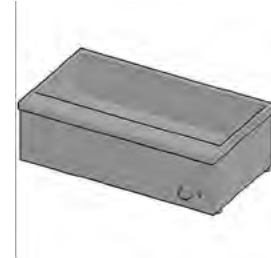
MOD. / COD.	DESCRIZIONE / DESCRIPTION / BEZEICHNUNG / DESCRIPTION / DESCRIPCIÓN DIMENSIONI / DIMENSIONS / ABMESSUNGEN / DIMENSIONS / DIMENSIONES	POTENZA / POWER / LEISTUNG / PUISSANCE / POTENCIA VOLTAGGIO / VOLTAGE / SPANNUNG / VOLTAGE / VOLTAJE	⚡ kW kcal/h	⚡ kW V~ Hz	PREZZO / PRICE € PREIS / PRIX / PRECIO KG / M ³
VEC-20 50158012	VETRINA RISCALDATA - 2 PIANI EN Heated display units - 2 shelves • DE Heisse-Vitrine - 2 Etagen • FR Vitrine chaude - 2 etages • ES VITRINA CALEFACTORA DOBLE cm. 50x 35x 41h		0,4 kW 230V~ 50/60 Hz		743,00 15 / 0,10
VEC-82 50158022	cm. 80x 35x 41h		0,7 kW 230V~ 50/60 Hz		947,00 23 / 0,14
SV-13 25010013	BAGNOMARIA Vasca per GN 1/3, h 15 cm. EN Bain-marie - Bowl for GN 1/3, h 15 cm. • DE Wasserbad - Becken für GN 1/3, h 15 cm. • FR Bain-marie - Cuve pour GN 1/3, h. 15 cm. • ES BAÑO DE MARÍA - CUBA PARA GN 1/3, H. 15 CM. cm. 20,5x 41x 22h		0,83 kW 230V~ 50/60 Hz		374,00 5 / 0,04
SV-12 25010120	BAGNOMARIA Vasca per GN 1/2, h 15 cm. EN Bain-marie - Bowl for GN 1/2, h 15 cm. • DE Wasserbad - Becken für GN 1/2, h 15 cm. • FR Bain-marie - Cuve pour GN 1/2, h. 15 cm. • ES BAÑO DE MARÍA - CUBA PARA GN 1/2, H. 15 CM. cm. 29,5x 41x 22h		0,83 kW 230V~ 50/60 Hz		491,00 6 / 0,06
SV-23 25010230	BAGNOMARIA Vasca per GN 2/3, h 15 cm. EN Bain-marie - Bowl for GN 2/3, h 15 cm. • DE Wasserbad - Becken für GN 2/3, h 15 cm. • FR Bain-marie - Cuve pour GN 2/3, h. 15 cm. • ES BAÑO DE MARÍA - CUBA PARA GN 2/3, H. 15 CM. cm. 38x 41x 22h		1,19 kW 230V~ 50/60 Hz		531,00 7 / 0,09
SV-11 25011100	BAGNOMARIA Vasca per GN 1/1, h 15 cm. EN Bain-marie - Bowl for GN 1/1, h 15 cm. • DE Wasserbad - Becken für GN 1/1, h 15 cm. • FR Bain-marie - Cuve pour GN 1/1, h. 15 cm. • ES BAÑO DE MARÍA - CUBA PARA GN 1/1, H. 15 CM. cm. 56x 41x 22h		1,66 kW 230V~ 50/60 Hz		597,00 9 / 0,08
SV-113 25011130	BAGNOMARIA Vasca per GN 1/1 + GN 1/3, h 15 cm. EN Bain-marie - Bowl for GN 1/1 + GN 1/3, h 15 cm. • DE Wasserbad - Becken für GN 1/1 + GN 1/3, h 15 cm. • FR Bain-marie - Cuve pour GN 1/1 + GN 1/3, h 15 cm. • ES BAÑO DE MARÍA - CUBA PARA GN 1/1 + GN 1/3, H 15 CM. cm. 73,5x 41x 22h		2,49 kW 230V~ 50/60 Hz		874,00 11 / 0,13

BAGNOMARIA

MOD. _____ DESCRIZIONE/DESCRIPTION/BEZEICHNUNG/DESCRIPTION/DESCRIPCIÓN POTENZA/POWER/LEISTUNG/PUISSANCE/POTENCIA ⚡kW ⚡kw PREZZO/PRICE €
 COD. _____ DIMENSIONI/DIMENSIONS/ABMESSUNGEN/DIMENSIONS/DIMENSIONES VOLTAGGIO/VOLTAGE/SPANNUNG/VOLTAGE/VOLTAJE kcal/h V~ Hz PREIS/PRIX/PRECIO €
 KG / M³

SV-123
 25011230 BAGNOMARIA Vasca per GN 1/1 + GN 2/3, h 15 cm.
EN Bain marie - Bowl for GN 1/1 + GN 2/3, h 15 cm. • **DE**
 Wasserbad - Becken für GN 1/1 + GN 2/3, h 15 cm. • **FR** Bain-marie
 - Cuve pour GN 1/1 + GN 2/3, h 15 cm. • **ES BAÑO DE MARÍA -**
CUBA PARA GN 1/1 + GN 2/3, H 15 CM
cm. 91x 41x 22h



⚡ 2,49 kW
 230V~
 50/60 Hz **961,00**
 14 / 0,13

FF-13
 25050013 FALSO FONDO FORATO
EN Perforated false bottom • **DE** Gelochter Bodenrost • **FR** Faux-fond
 perforé • **ES FALSO FONDO AGUJERADO**

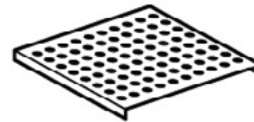

41,00
 0.4 /

FF-12
 25050120

52,00
 0.6 /

FF-23
 25050230

57,00
 0.8 /

FF-11
 25051100

76,00
 1.2 /

FF-113
 25051130

84,00
 1.7 /

FF-123
 25051230

103,00
 2 /

SEP-325
 25023250 SEPARATORE
EN Separator • **DE** Trenner • **FR** Separateur • **ES SEPARADOR**
cm. 32,5



22,00
 0.1 /

GN-1/6
 25031716 BACINELLA GN
EN Container GN • **DE** Gastronorm-Behälter • **FR** Bac GN • **ES**
CUBA GN
cm. 17,6x 16,2x 15h



32,00
 0.3 /

GN-1/4
 25032616 **cm. 26,5x 16,2x 15h**



37,00
 0.4 /

GN-1/3
 25033217 **cm. 32,5x 17,5x 15h**



39,00
 0.5 /

ACCESSORI BAGNOMARIA

MOD. _____ DESCRIZIONE/DESCRIPTION/BEZEICHNUNG/DESCRIPTION/DESCRIPCIÓN POTENZA/POWER/LEISTUNG/PUISSANCE/POTENCIA $\frac{\text{kW}}{\text{kcal/h}}$ $\frac{\text{kV}}{\text{V}}$ PREZZO/PRICE €
 COD. _____ DIMENSIONI/DIMENSIONS/ABMESSUNGEN/DIMENSIONS/DIMENSIONES VOLTAGGIO/VOLTAGE/SPANNUNG/VOLTAGE/VOLTAJE $\frac{\text{Hz}}{\text{Hz}}$ PREIS/PRIX/PRECIO €
 KG / M³

GN-1/2 cm. 32,5x 26,5x 15h **45,00**
 25033226 0.7 /



GN-2/3 cm. 35,4x 32,5x 15h **73,00**
 25033532 0.9 /



GN-1/1 cm. 53x 32,5x 15h **77,00**
 25035332 1 /



C-1/6 COPERCHIO GN **12,00**
 25041716 **EN** Lid GN • **DE** Deckel GN • **FR** Couvercle GN • **ES TAPA GN** 0.1 /
 cm. 17,6x 16,2



C-1/4 cm. 26,5x 16,2 **14,00**
 25042616 0.15 /



C-1/3 cm. 32,5x 17,5 **18,00**
 25043217 0.2 /



C-1/2 cm. 32,5x 26,5 **24,00**
 25043226 0.25 /



C-2/3 cm. 35,4x 32,5 **27,00**
 25043532 0.3 /



ACCESSORI BAGNOMARIA

MOD.
COD.

DESCRIZIONE/DESCRIPTION/BEZEICHNUNG/DESCRIPTION/DESCRIPCIÓN
DIMENSIONI/DIMENSIONS/ABMESSUNGEN/DIMENSIONS/DIMENSIONES

POTENZA/POWER/LEISTUNG/PUISSANCE/POTENCIA
VOLTAGGIO/VOLTAGE/SPANNUNG/VOLTAGE/VOLTAJE

⚡ kW kcal/h
⚡ kw V- Hz

PREZZO/PRICE €
PREIS/PRIX/PRECIO €
KG / M²

C-1/1
25045332

cm. 53x 32,5



38,00
0,5 /

300GLTD

AFFETTATRICE A GRAVITA' lama Ø300mm, 0,25HP, capacità taglio cm.23x17 spessore 0÷15mm. Fusione in lega di alluminio anodizzato. Affilatoio incorporato. Trasmissione a cinghia.

EN GRAVITY SLICER blade Ø300mm, 0,25HP. Cutting capacity cm.23x17 thickness 0÷15mm. Made from highly polished anodised food-grade aluminium. Sharpening. Belt transmission. • **DE** Schwerkraftschneidemaschine, scneidescheibe Ø300mm, 0,25HP. nutz-schnitt cm.23x17 Dicke 0÷15mm. • **FR** TRANCHEUSE À GRAVITÉ, lame Ø300mm, 0,25HP. coupe utile cm.23x17, epaisseur 0÷15mm. • **ES CORTADORAS DE GRAVEDAD, CUCHILLA Ø300MM, 0,25HP. CAPACIDAD DE CORTE CM.23X17 ESPESSOR 0÷15MM.**

cm. 49x 61x 43h



⚡ 0,18 KW 1.753,00
230V~ 21 / 0,16
50 Hz

300TCKD

AFFETTATRICE VERTICALE per carne, lama Ø300mm, 0,35HP, capacità taglio cm.22x21 spessore 0÷15mm. Fusione in lega di alluminio anodizzato. Affilatoio incorporato. Trasmissione a cinghia.

EN VERTICAL MEAT SLICER blade Ø300mm, 0,35HP. Cutting capacity cm.22x21 thickness 0÷15mm. Made from highly polished anodised food-grade aluminium. Sharpening. Belt transmission. • **DE** VERTIKALE FLEISCHSCHNEIDER, scneidescheibe Ø300mm, 0,35HP. nutz-schnitt cm.22x21 Dicke 0÷15mm. • **FR** TRANCHEUSE À VIANDE VERTICALE, lame Ø300mm, 0,35HP. coupe utile cm.22x21, epaisseur 0÷15mm.

• **ES CORTADORA VERTICAL PARA CARNE, CUCHILLA Ø300MM, 0,35HP. CAPACIDAD DE CORTE CM.22X21 ESPESSOR 0÷15MM.**

cm. 62x 67x 50h



⚡ 0,26 KW 2.708,00
230V~ 23 / 0,16
50 Hz

RMS510TS2

FORNO MICROONDE DIGITALE con 20 programmi, camera cm.33x33x20h, 2450 Mhz. Interamente in acciaio inox. Piatto fisso con distribuzione microonde a mezzo antenna rotante. Timer di regolazione

EN MICROWAVE OVEN with 20 programs, chamber cm.33x33x20h, 2450 Mhz. Structured in s/steel. Fixed plate. Timer control • **DE** MIKROWELLEN, 20 Garprogramme, Garkammer cm.33x33x20h, 2450 Mhz. • **FR** FOUR A MICRO-ONDES, 20 programmes, chambrc cm.33x33x20h, 2450 Mhz. • **ES HORNOS DE MICROONDAS, 20 PROGRAMAS, CÁMARA CM.33X33X20H, 2450 MHZ. cm. 51x 40x 31h**



⚡ 1,15 KW 1.258,00
230V~ 17 / 0,16
50 Hz

A professional bakery oven, likely a convection oven, with a stainless steel finish. A prominent vertical red stripe runs down the center of the image. The text 'FREIDORAS PASTELERIA' is overlaid in large, white, bold, sans-serif font across the middle. The oven's control panel is visible at the top right, featuring a large red knob and several indicator lights. The oven door has a mesh window and a handle. The brand name 'LOTFULS' is visible on the lower right side of the oven door.

FREIDORAS PASTELERIA

LOTFULS

LOTFULS

FRIGGITRICI / FRY



FMPG-20 + 40280600



FMPE-30



F1-G



FPE-25 + 40280800

FRIGGITRICI ELETTRICHE - TOP

MOD. COD.	DESCRIZIONE/DESCRIPTION/BEZEICHNUNG/DESCRIPTION/DESCRIPCIÓN DIMENSIONI/DIMENSIONS/ABMESSUNGEN/DIMENSIONS/DIMENSIONES	POTENZA/POWER/LEISTUNG/PUISSANCE/POTENCIA VOLTAGGIO/VOLTAGE/SPANNUNG/VOLTAGE/VOLTAJE	⚡ kcal/h	⚡ kw V~ Hz	PREZZO/PRICE PREIS/PRIX/PRECIO € KG / M ³
FE-04EM 35010411	FRIGGITRICE Lt. 4 MONOFASE Cestino cm.13x23x10h - Produzione patate 5 kg/h EN Fryer lts. 4 singlephase - Basket cm. 13x23x10h - Production 5 kg/hr • DE Friteuse lt. 4 einphasig - Korb cm. 13x23x10h - Pommes frites: 5 kg/h • FR Friteuse lt. 4 monophasé - Panier cm. 13x23x10h - Production de pommes frites 5 Kg/h • ES FREIDORAS 4 LT. MONOFÁSICA - CESTA CM. 13X23X10H - PRODUCCIÓN PATATAS 5 KG/H cm. 18x 42x 30h			2,1 kW 230V~ 50 Hz	333,00 9 / 0,04
					
FE-07EM 35010710	FRIGGITRICE LT. 7 MONOFASE Cestino cm. 21x23,5x10h - Produzione patate 7 kg/h EN Fryer lts. 7 singlephase - Basket cm. 21x23,5x10h - Production 7 kg/hr • DE Friteuse lt. 7 einphasig - Korb cm. 21x23,5x10h - Pommes frites: 7 kg/h • FR Friteuse lt. 7 monophasé - Panier cm. 21x23,5x10h - Production de pommes frites 7 Kg/h • ES FREIDORAS 7 LT. MONOFÁSICA - CESTA CM. 21X23,5X10H - PRODUCCIÓN PATATAS 7 KG/H cm. 27x 42x 30h			3 kW 230V~ 50 Hz	373,00 9 / 0,05
					
FE-77EM 35020710	FRIGGITRICE LT. 7+7 MONOFASE 2 cestini cm. 21x23,5x10h - Produzione patate 14 kg/h EN Fryer lts. 7+7 singlephase - 2 baskets cm. 21x23,5x10h - Production 14 kg/hr • DE Friteuse lt. 7+7 einphasig - 2 Korbe cm. 21x23,5x10h - Pommes frites: 14 kg/h • FR Friteuse lt. 7+7 monophasé - 2 Paniers cm. 21x23,5x10h - Production de pommes frites 14 Kg/h • ES FREIDORAS 7+7 LT. MONOFÁSICA - 2 CESTAS CM. 21X23,5X10H - PRODUCCIÓN PATATAS 14 KG/H cm. 54x 42x 30h			6 kW 230V~ 50 Hz	692,00 16 / 0,10
					
FEM-6 35010610	FRIGGITRICE LT. 6 MONOFASE Vasca cm. 22x32,5x20h - Cestino cm.20x27x11h - Produzione patate 7 kg/h EN Fryer lts. 6 singlephase - Tank cm. 22x32,5x20h - Basket cm. 20x27x11h - Production 7 kg/hr • DE Friteuse lt. 6 einphasig - Becken cm. 22x32,5x20h - Korb cm. 20x27x11h - Pommes frites 7 kg/h • FR Friteuse lt. 6 monophasé - Cuve cm. 22x32,5x20h - Panier cm. 20x27x11h - Production de pommes frites 7 Kg/h • ES FREIDORAS 6 LT. MONOFÁSICA - CUBA CM. 22X32,5X20H - CESTA CM. 20X27X11H - PRODUCCIÓN PATATAS 7 KG/H cm. 30x 51x 25h			3 kW 230V~ 50/60 Hz	1.171,00 13 / 0,08
					
FE-8 35010830	FRIGGITRICE LT. 8 TRIFASE Vasca cm. 22x32,5x20h - Cestino cm.20x27x11h - Produzione patate 9 kg/h EN Fryer lts. 8 threephase - Tank cm. 22x32,5x20h - Basket cm. 20x27x11h - Production 9 kg/hr • DE Friteuse lt. 8 dreiphasig - Becken cm. 22x32,5x20h - Korb cm. 20x27x11h - Pommes frites 9 kg/h • FR Friteuse lt. 8 triphase - Cuve cm. 22x32,5x20h - Panier cm. 20x27x11h - Production de pommes frites 9 Kg/h • ES FREIDORAS 8 LT. TRIFÁSICA - CUBA CM. 22X32,5X20H - CESTA CM. 20X27X11H - PRODUCCIÓN PATATAS 9 KG/H cm. 30x 51x 25h			5,4 kW 400V~3N 230V~3 50/60 Hz	1.301,00 15 / 0,08
					
FE-10 35011030	FRIGGITRICE LT. 10 TRIFASE Vasca cm. 29x32,5x20h - Cestino cm.26x27x11h - Produzione patate 10 kg/h EN Fryer lts. 10 threephase - Tank cm. 29x32,5x20h - Basket cm. 26x27x11h - Production 10 kg/hr • DE Friteuse lt. 10 dreiphasig - Becken cm. 29x32,5x20h - Korb cm. 26x27x11h - Pommes frites 10 kg/h • FR Friteuse lt. 10 triphase - Cuve cm. 29x32,5x20h - Panier cm. 26x27x11h - Production de pommes frites 10 Kg/h • ES FREIDORAS 10 LT. TRIFÁSICA - CUBA CM. 29X32,5X20H - CESTA CM. 26X27X11H - PRODUCCIÓN PATATAS 10 KG/H cm. 40x 70x 25h			6 kW 400V~3N 230V~3 50/60 Hz	1.514,00 21 / 0,22
					

FRIGGITRICI ELETTRICHE - TOP

MOD. _____
COD. _____

DESCRIZIONE/DESCRIPTION/BEZEICHNUNG/DESCRIPTION/DESCRIPCIÓN
DIMENSIONI/DIMENSIONS/ABMESSUNGEN/DIMENSIONS/DIMENSIONES

POTENZA/POWER/LEISTUNG/PUISSANCE/POTENCIA
VOLTAGGIO/VOLTAGE/SPANNUNG/VOLTAGE/VOLTAJE

⚡ kW _____
kcal/h _____
V~ _____
Hz _____

PREZZO/PRICE €
PREIS/PRIX/PRECIO _____
KG / M³

FEM-2/6
35020610

FRIGGITRICE LT. 6+6 MONOFASE 2 vasche cm. 22x32,5x20h - 2 cesti cm. 20x27x11h - Produzione patate 14 kg/h
EN Fryer lts. 6+6 singlephase - 2 tanks cm. 22x32,5x20h - 2 baskets cm. 20x27x11h - Production 14 kg/hr • **DE** Friteuse lt. 6+6 einphasig - 2 Becke cm. 22x32,5x20h - 2 Korbe cm. 20x27x11h - Pommes frites 14 kg/h • **FR** Friteuse lt. 6+6 monophasé - 2 cuves cm. 22x32,5x20h - 2 Paniers cm. 20x27x11h - Production de pommes 14 Kg/h • **ES FREIDORAS 6+6 LT. MONOFÁSICA - 2 CUBAS CM. 22X32,5X20H - 2 CESTAS CM. 20X27X11H - PRODUCCIÓN PATATAS 14 KG/H**
cm. 60x 51x 25h



⚡ 6 kW _____ **2.190,00**
230V~ _____ 13 / 0,16
50/60 Hz _____

FE-2/8
35020830

FRIGGITRICE LT. 8+8 TRIFASE 2 vasche cm. 22x32,5x20h - 2 cesti cm. 20x27x11h - Produzione patate 18 kg/h
EN Fryer lts. 8+8 threephase - 2 tanks cm. 22x32,5x20h - 2 baskets cm. 20x27x11h - Production 18 kg/hr • **DE** Friteuse lt. 8+8 dreiphasig - 2 Becke cm. 22x32,5x20h - 2 Korbe cm. 20x27x11h - Pommes frites 18 kg/h • **FR** Friteuse lt. 8+8 triphase - 2 cuves cm. 22x32,5x20h - 2 Paniers cm. 20x27x11h - Production de pommes 18 Kg/h • **ES FREIDORAS 8+8 LT. TRIFÁSICA - 2 CUBAS CM. 22X32,5X20H - 2 CESTAS CM. 20X27X11H - PRODUCCIÓN PATATAS 18 KG/H**
cm. 60x 51x 25h

⚡ 10,8 kW _____ **2.295,00**
400V~3N _____ 27 / 0,16
230V~3 _____
50/60 Hz _____

FE-2/10
35021030

FRIGGITRICE LT. 10+10 TRIFASE 2 vasche cm. 29x32,5x20h - 2 cesti cm. 26x27x11h - Produzione patate 20 kg/h
EN Fryer lts. 10+10 threephase - 2 tanks cm. 29x32,5x20h - 2 baskets cm. 26x27x11h - Production 20 kg/hr • **DE** Friteuse lt. 10+10 dreiphasig - 2 Becke cm. 29x32,5x20h - 2 Korbe cm. 26x27x11h - Pommes frites 20 kg/h • **FR** Friteuse lt. 10+10 triphase - 2 cuves cm. 29x32,5x20h - 2 Paniers cm. 26x27x11h - Production de pommes 20 Kg/h • **ES FREIDORAS 10+10 LT. TRIFÁSICA - 2 CUBAS CM. 29X32,5X20H - 2 CESTAS CM. 26X27X11H - PRODUCCIÓN PATATAS 20 KG/H**
cm. 80x 70x 25h



⚡ 12 kW _____ **2.632,00**
400V~3N _____ 38 / 0,42
230V~3 _____
50/60 Hz _____

S-3
05210300

CAVALLETTO BASE
EN Stand • **DE** Untergestell • **FR** Piétement simple • **ES SOPORTE BASE**
cm. 30x 40x 55h

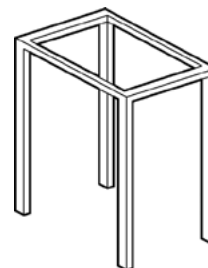

229,00
2 / 0,12

S-6
05210600

cm. 60x 40x 55h

252,00
3 / 0,22

R-3
05240300

RIPIANO
EN Shelf • **DE** Abstellbrett • **FR** Etagère • **ES ESTANTE**
cm. 26x 39,5x 3h

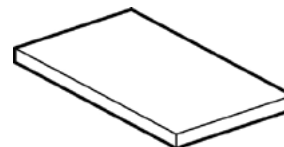

114,00
1 / 0,01

R-6
05240600

cm. 56x 39,5x 3h

143,00
2 / 0,01

S-40
40210400

CAVALLETTO CON RIPIANO
EN Stand with shelf • **DE** Untergestell offen mit boden • **FR** Support avec etagere • **ES SOPORTE CON ESTANTE**
cm. 40x 58,5x 60h

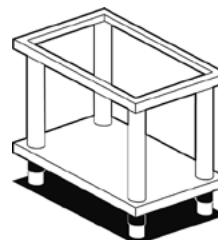

571,00
20 / 0,18

S-80
40210800

cm. 80x 58,5x 60h



676,00
26 / 0,35

ACCESSORI FRIGGITRICI

MOD. COD.	DESCRIZIONE/DESCRIPTION/BEZEICHNUNG/DESCRIPTION/DESCRIPCIÓN DIMENSIONI/DIMENSIONS/ABMESSUNGEN/DIMENSIONS/DIMENSIONES	POTENZA/POWER/LEISTUNG/PUISSANCE/POTENCIA VOLTAGGIO/VOLTAGE/SPANNUNG/VOLTAGE/VOLTAJE	⚡ kW kcal/h	⚡ kw V~ Hz	PREZZO/PRICE € PREIS/PRIX/PRECIO € KG / M³
M-40 40220400	BASE A GIORNO EN Open base unit • DE Untergestell offen • FR Base ouverte • ES BASE ABIERTA cm. 40x 58,5x 60h				469,00 14 / 0,18
MP-40 40220401	BASE CON PORTA EN Stand with door • DE Unterbau mit Flügeltüren • FR Placard avec porte • ES BASE CON PUERTA cm. 40x 61,5x 60h				642,00 17 / 0,18
MC-40 40220420	BASE CON 2 CASSETTI GN 1/1 con 2 GN 1/1 h 15 in plastica EN Stand with 2 drawers GN 1/1, with 2 plastic containers GN 1/1 h 15 • DE Unterbau mit 2 Schubladen GN 1/1 mit 2 GN 1/1 h 15 Kunststoffbehältern • FR Placard avec 2 tiroirs GN 1/1 avec 2 bacs GN 1/1 h 15 en plastique • ES BASE CON 2 CAJONES GN 1/1 CON 2 GN 1/1 H 15 DE PLÁSTICO cm. 40x 61,5x 60h				1.007,00 28 / 0,18
FME-10 35311030	FRIGGITRICE CON MOBILE - LT. 10 TRIFASE Vasca cm. 29x32,5x18,5h - Cestino cm.26x27x11h. Bacinella raccogliolio con filtro. Prod. patate: 10 kg/h EN Cabinet fryer lt. 10 threephase Bowl cm. 29x32,5x18,5h - Basket cm. 26x27x11h. Drip tray with sieve. Production: 10 kg/h • DE Standfriteuse lt. 10 dreiphasig Becken cm. 29x32,5x18,5h - Korb cm. 26x27x11h. Fettauffangschale mit Sieb. Pommes frites: 10 kg/h • FR Friteuse sur placard lt.10 triphase Cuve cm. 29x32,5x18,5h - Panier cm. 26x27x11h. Collecteur d'huile avec filtre. Production de pommes frites: 10 kg/h • ES FREIDORAS CON MUEBLE 10 LT. TRIFÁSICA CUBA CM. 29X32,5X18,5H - CESTA CM. 26X27X11H. BANDEJA RECOGE ACEITE CON FILTRO. PRODUCCIÓN PATATAS: 10 KG/H cm. 40x 70x 85h		⚡ 6 kW 400V~3N 230V~3 50/60 Hz	1.961,00 35 / 0,36	
FME-15 35311530	FRIGGITRICE CON MOBILE - LT. 15 TRIFASE Vasca cm. 33x40x18,5h - Cestino cm.30x33x12h. Bacinella raccogliolio con filtro. Prod. patate: 12 kg/h EN Cabinet fryer lt. 15 threephase Bowl cm. 33x40x18,5h - Basket cm. 30x33x12h. Drip tray with sieve. Production: 12 kg/h • DE Standfriteuse lt. 15 dreiphasig Becken cm. 33x40x18,5h - Korb cm. 30x33x12h. Fettauffangschale mit Sieb. Pommes frites: 12 kg/h • FR Friteuse sur placard lt.15 triphase Cuve cm. 33x40x18,5h - 2 Paniers cm. 30x33x12h. Collecteur d'huile avec filtre. Production de pommes frites: 12 kg/h • ES FREIDORAS CON MUEBLE 15 LT. TRIFÁSICA CUBA CM. 33X40X18,5H - CESTA CM. 30X33X12H. BANDEJA RECOGE ACEITE CON FILTRO. PRODUCCIÓN PATATAS: 12 KG/H cm. 40x 70x 85h		⚡ 9 kW 400V~3N 50/60 Hz	2.289,00 42 / 0,36	

FRIGGITRICI ELETTRICHE

MOD. _____
COD. _____

DESCRIZIONE/DESCRIPTION/BEZEICHNUNG/DESCRIPTION/DESCRIPCIÓN
DIMENSIONI/DIMENSIONS/ABMESSUNGEN/DIMENSIONS/DIMENSIONES

POTENZA/POWER/LEISTUNG/PUISSANCE/POTENCIA
VOLTAGGIO/VOLTAGE/SPANNUNG/VOLTAGE/VOLTAJE

⚡ kW _____
kcal/h _____
V~ _____
Hz _____

PREZZO/PRICE € _____
PREIS/PRIX/PRECIO _____
KG / M³ _____

FME-2/10
35321030

FRIGGITRICE CON MOBILE - LT. 10+10 TRIFASE 2 vasche cm. 29x32,5x18,5h - 2 cestri cm.26x27x11h. 2 bacinelle raccogliolio con filtro. Produzione patate 20 kg/h
EN Cabinet fryer lt. 10+10 threephase 2 tanks cm. 29x32,5x18,5h - 2 baskets cm. 26x27x11h. 2 drip trays with sieves. Production 20 kg/hr
• **DE** Standfriteuse lt. 10+10 dreiphasig 2 Becke cm. 29x32,5x18,5h - 2 Korbe cm. 26x27x11h. 2 Fettauffangschalen mit Sieb. Pommes frites 20 kg/pro Stunde • **FR** Friteuse sur placard lt.10+10 triphase 2 cuves cm. 29x32,5x18,5h - 2 Paniers cm. 26x27x11h. 2 bacs de récupération de l'huile avec filtre. Production de pommes 20 Kg/h • **ES FREIDORAS CON MUEBLE 10+10 LT. TRIFÁSICA 2 CUBAS CM. 29X32,5X18,5H - 2 CESTAS CM. 26X27X11H. 2 BANDEJAS RECOGE ACEITE CON FILTRO. PRODUCCIÓN PATATAS 20 KG/H**
cm. 80x 70x 85h



⚡ 12 kW _____ **3.359,00**
400V~3N _____ 65 / 0,70
230V~3 _____
50/60 Hz _____

FME-2/15
35321530

FRIGGITRICE CON MOBILE - LT. 15+15 TRIFASE 2 vasche cm. 33x40x18,5h - 2 cestri cm.30x33x12h. 2 bacinella raccogliolio con filtro. Produzione patate 24 kg/h
EN Cabinet fryer lt. 15+15 threephase 2 tanks cm. 33x40x18,5h - 2 baskets cm. 30x33x12h. 2 drip trays with sieves. Production 24 kg/hr
• **DE** Standfriteuse lt. 15+15 dreiphasig 2 Becke cm. 33x40x18,5h - 2 Korbe cm. 30x33x12h. 2 Fettauffangschalen mit Sieb. Pommes frites 24 kg/pro Stunde • **FR** Friteuse sur placard lt.15+15 triphase 2 cuves cm. 33x40x18,5h - 2 Paniers cm. 30x33x12h. 2 bacs de récupération de l'huile avec filtre. Production de pommes 24 Kg/h • **ES FREIDORAS CON MUEBLE 15+15 LT. TRIFÁSICA 2 CUBAS CM. 33X40X18,5H - 2 CESTAS CM. 30X33X12H. 2 BANDEJAS RECOGE ACEITE CON FILTRO. PRODUCCIÓN PATATAS 24 KG/H**
cm. 80x 70x 85h

⚡ 18 kW _____ **3.654,00**
400V~3N _____ 75 / 0,70
50/60 Hz _____

531013500

CESTINO 1/2 per FME-15
EN Basket 1/2 for FME-15 • **DE** Korb 1/2 für Friteuse FME-15 • **FR** Panier 1/2 pour FME-15 • **ES CESTA 1/2 PARA FME-15**
cm. 14x 33x 12h



77,00
0.8 / 0,04

531014400

CESTINO 1/2 per FME-10
EN Basket 1/2 for FME-10 • **DE** Korb 1/2 für Friteuse FME-10 • **FR** Panier 1/2 pour FME-10 • **ES CESTA 1/2 PARA FME-10**
cm. 10x 25x 10h

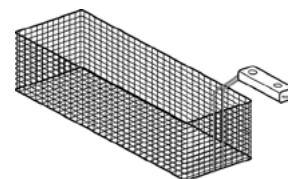

56,00
0.6 / 0,03



FPE-20
35032030

FRIGGITRICE PASTICCERIA TRIFASE - 17 litri Vasca cm. 50x42,5x17,5h - 1 cesto cm. 47x35x8h Filtro e coperchio vasca
EN Confectioner's fryer threephase - 17 liters Tank cm. 50x42,5x17,5h - 1 basket cm. 47x35x8h Sieve and lid for tank • **DE** Friteuse für Konditorei dreiphasig - 17 Liter Becken cm. 50x42,5x17,5h - 1 Korb cm. 47x35x8h Filter und Deckel für Becken • **FR** Friteuse patisserie triphase - 17 litres Cuve cm. 50x42,5x17,5h - 1 panier cm. 47x35x8h Filtre et couvercle pour cuve • **ES FREIDORA REPOSTERÍA TRIFÁSICA - 17 LITROS CUBA CM. 50X42,5X17,5H - 1 CESTA CM. 47X35X8H FILTRO Y TAPA CUBA**
cm. 60x 70x 25h

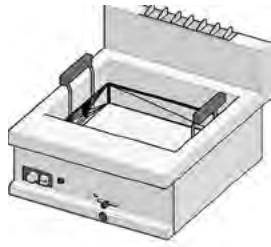

⚡ 6,6 kW _____ **1.901,00**
400V~3N _____ 32 / 0,31
230V~3 _____
50/60 Hz _____

FRIGGITRICI PASTICCERIA ELETTRICHE - TOP

MOD. COD.	DESCRIZIONE/DESCRIPTION/BEZEICHNUNG/DESCRIPTION/DESCRIPCIÓN DIMENSIONI/DIMENSIONS/ABMESSUNGEN/DIMENSIONS/DIMENSIONES	POTENZA/POWER/LEISTUNG/PUISSANCE/POTENCIA VOLTAGGIO/VOLTAGE/SPANNUNG/VOLTAGE/VOLTAGE	$\frac{kW}{kcal/h}$ $\frac{V}{Hz}$	PREZZO/PRICE € PREIS/PRIX/PRECIO KG / M ³
FPE-25 35032540	FRIGGITRICE PASTICCERIA TRIFASE - 24 litri Vasca cm. 70x42,5x17,5h - 1 cesto cm. 67x35x8h Filtro e coperchio vasca EN Confectioner's fryer threephase - 24 liters Tank cm. 70x42,5x17,5h - 1 basket cm. 67x35x8h Sieve and lid for tank • DE Friteuse für Konditorei dreiphasig - 24 Liter Becken cm. 70x42,5x17,5h - 1 Korb cm. 67x35x8h Filter und Deckel für Becken • FR Friteuse patisserie triphase - 24 litres Cuve cm. 70x42,5x17,5h - 1 panier cm. 67x35x8h Filtre et couvercle pour cuve • ES FREIDORA REPOSTERÍA TRIFÁSICA - 24 LITROS CUBA CM. 70X42,5X17,5H - 1 CESTA CM. 67X35X8H FILTRO Y TAPA CUBA cm. 80x 70x 25h		$\frac{10,2 kW}{230V\sim 3}$ 50/60 Hz	2.400,00 40 / 0,40
				
FPE-25 35032530	cm. 80x 70x 25h		$\frac{10,2 kW}{400V\sim 3N}$ 50/60 Hz	2.400,00 40 / 0,40
FPEH-25 35032531	FRIGGITRICE PASTICCERIA POTENZIATA TRIFASE - 24 litri Vasca cm. 70x42,5x17,5h - 1 cesto cm. 67x35x8h Filtro e coperchio vasca EN Powerfull Confectioner's fryer threephase - 24 liters Tank cm. 70x42,5x17,5h - 1 basket cm. 67x35x8h Sieve and lid for tank • DE Friteuse leistungsfähiges für Konditorei dreiphasig - 24 Liter Becken cm. 70x42,5x17,5h - 1 Korb cm. 67x35x8h Filter und Deckel für Becken • FR Friteuse patisserie triphase plus puissants- 24 litres Cuve cm. 70x42,5x17,5h - 1 panier cm. 67x35x8h Filtre et couvercle pour cuve • ES FREIDORA REPOSTERÍA TRIFÁSICA CON MAYOR POTENCIA - 24 LITROS CUBA CM. 70X42,5X17,5H - 1 CESTA CM. 67X35X8H FILTRO Y TAPA CUBA cm. 80x 70x 25h		$\frac{18 kW}{400V\sim 3N}$ 50/60 Hz	2.608,00 40 / 0,40
FPG-20 40032050	FRIGGITRICE PASTICCERIA GAS - 20 litri Vasca cm. 50x38x24h - 1 cesto cm. 47x35x8h Filtro e coperchio vasca EN Gas confectioner's fryer - 20 liters Tank cm. 50x38x24h - 1 basket cm. 47x35x8h Sieve and lid for tank • DE Gasfriteuse für Konditorei - 20 Liter Becken cm. 50x38x24h - 1 Korb cm. 47x35x8h Filter und Deckel für Becken • FR Friteuse patisserie à gaz - 20 litres Cuve cm. 50x38x24h - 1 panier cm. 47x35x8h Filtre et couvercle pour cuve • ES FREIDORA REPOSTERÍA GAS - 20 LITROS CUBA CM. 50X38X24H - 1 CESTA CM. 47X35X8H FILTRO Y TAPA CUBA cm. 60x 70x 25h		$\frac{11,2 kW}{9.630 kcal/h}$	2.698,00 43 / 0,31
				
FPG-30 40033050	FRIGGITRICE PASTICCERIA GAS - 28 litri Vasca cm. 70x38x24h - 1 cesto cm. 67x35x8h Filtro e coperchio vasca EN Gas confectioner's fryer - 28 liters Tank cm. 70x38x24h - 1 basket cm. 67x35x8h Sieve and lid for tank • DE Gasfriteuse für Konditorei - 28 Liter Becken cm. 70x38x24h - 1 Korb cm. 67x35x8h Filter und Deckel für Becken • FR Friteuse patisserie à gaz - 28 litres Cuve cm. 70x38x24h - 1 panier cm. 67x35x8h Filtre et couvercle pour cuve • ES FREIDORA REPOSTERÍA GAS - 28 LITROS CUBA CM. 70X38X24H - 1 CESTA CM. 67X35X8H FILTRO Y TAPA CUBA cm. 80x 70x 25h		$\frac{16,5 kW}{14.190 kcal/h}$	3.122,00 57 / 0,40
				
S-60 40210600	CAVALLETTO CON RIPIANO EN Stand with shelf • DE Untergestell offen mit boden • FR Support avec etagere • ES SOPORTE CON ESTANTE cm. 60x 58,5x 60h			572,00 23 / 0,27
				
S-80 40210800	cm. 80x 58,5x 60h			676,00 26 / 0,35

ACCESSORI PASTICCERIA

MOD. COD.	DESCRIZIONE/DESCRIPTION/BEZEICHNUNG/DESCRIPTION/DESCRIPCIÓN DIMENSIONI/DIMENSIONS/ABMESSUNGEN/DIMENSIONS/DIMENSIONES	POTENZA/POWER/LEISTUNG/PUISSANCE/POTENCIA VOLTAGGIO/VOLTAGE/SPANNUNG/VOLTAGE/VOLTAJE	⚡ kW kcal/h	⚡ kw V~ Hz	PREZZO/PRICE € PREIS/PRIX/PRECIO KG / M³
M-60 40220600	BASE A GIORNO EN Open base unit • DE Untergestell offen • FR Base ouverte • ES BASE ABIERTA cm. 60x 58,5x 60h				765,00 18 / 0,27
M-80 40220800	cm. 80x 58,5x 60h				868,00 22 / 0,35
MP-60 40220602	BASE CON PORTE EN Stand with doors • DE Unterbau mit Flügeltüren • FR Placard avec portes • ES BASE CON PUERTAS cm. 60x 61,5x 60h				1.000,00 23 / 0,27
MP-80 40220802	cm. 80x 61,5x 60h				1.119,00 28 / 0,35
MCP-80 40220821	BASE CON PORTA E CASSETTI 2 x GN 1/1 h 15 in plastica EN Stand with door and drawers 2 plastic containers GN 1/1 h 15 • DE Unterbau mit Flügeltür und Schubladen 2 x GN 1/1 h 15 Kunststoffbehältern • FR Placard avec porte et tiroirs 2 bacs GN 1/1 h 15 en plastique • ES BASE CON PUERTA Y CAJONES 2 X GN 1/1 H 15 DE PLÁSTICO cm. 80x 61,5x 60h				1.729,00 40 / 0,35
MC-80 40220820	BASE CON 2 CASSETTI GN 2/1 con 4 GN 1/1 h 15 in plastica EN Stand with 2 drawers GN 2/1, with 4 plastic containers GN 1/1 h 15 • DE Unterbau mit 2 Schubladen GN 2/1 mit 4 GN 1/1 h 15 Kunststoffbehältern • FR Placard avec 2 tiroirs GN 2/1 avec 4 bacs GN 1/1 h 15 en plastique • ES BASE CON 2 CAJONES GN 2/1 CON 4 GN 1/1 H 15 DE PLÁSTICO cm. 80x 61,5x 60h				1.729,00 41 / 0,35
FMPE-20 35332030	FRIGGITRICE PASTICCERIA SU MOBILE TRIFASE - 17 litri Vasca cm. 50x42,5x17,5h - 1 cesto cm. 47x35x8h Filtro e coperchio vasca - Bacinella raccogliolio con filtro EN Confectioner's cabinet fryer threephase - 17 liters Tank cm. 50x42,5x17,5h - 1 basket cm. 47x35x8h Sieve and lid for tank. Drip tray with sieve • DE Friteuse für Konditorei mit Untergestell dreiphasig - 17 Liter Becken cm. 50x42,5x17,5h - 1 Korb cm. 47x35x8h Sieb und Deckel für Becken - Fettauffangschale mit Sieb • FR Friteuse patisserie sur placard triphase - 17 litres Cuve cm. 50x42,5x17,5h - 1 panier cm. 47x35x8h Filtre et couvercle pour cuve - Collecteur d'huile avec filtre • ES FREIDORA REPOSTERÍA EN MUEBLE TRIFÁSICA - 17 LITROS CUBA CM. 50X42,5X17,5H - 1 CESTA CM. 47X35X8H FILTRO Y TAPA CUBA - BANDEJA RECOGE ACEITE CON FILTRO cm. 60x 70x 85h		⚡ 6,6 kW 400V~3N 230V~3 50/60 Hz		2.821,00 60 / 0,59



FRIGGITRICI PASTICCERIA ELETTRICHE

MOD. COD.	DESCRIZIONE/DESCRIPTION/BEZEICHNUNG/DESCRIPTION/DESCRIPCIÓN DIMENSIONI/DIMENSIONS/ABMESSUNGEN/DIMENSIONS/DIMENSIONES	POTENZA/POWER/LEISTUNG/PUISSANCE/POTENCIA VOLTAGGIO/VOLTAGE/SPANNUNG/VOLTAGE/VOLTAJE	⚡ kcal/h ⚡ kW V~ Hz	PREZZO/PRICE € PREIS/PRIX/PRECIO KG / M ³
FMPE-25 35332540	FRIGGITRICE PASTICCERIA TRIFASE - 24 litri Vasca cm. 70x42,5x17,5h - 1 cesto cm. 67x35x8h Filtro e coperchio vasca - Bacinella raccogliolio con filtro EN Confectioner's cabinet fryer threephase - 24 liters - Tank cm. 70x42,5x17,5h 1 basket cm. 67x35x8h - Sieve and lid for tank - Drip tray with sieve • DE Friteuse für Konditorei mit Untergestell dreiphasig - 24 Liter - Becken cm. 70x42,5x17,5h 1 Korb cm. 67x35x8h - Einlegesieb mit Deckel für Becken - Fettauffangschale mit Sieb • FR Friteuse patisserie triphase - 24 litres - Cuve cm. 70x42,5x17,5h. 1 panier cm. 67x35x8h Filtre et couvercle pour cuve - Collecteur d'huile avec filtre • ES FREIDORA REPOSTERÍA TRIFÁSICA - 24 LITROS - CUBA CM. 70X42,5X17,5H - 1 CESTA CM. 67X35X8H FILTRO Y TAPA CUBA - BANDEJA RECOGE ACEITE CON FILTRO cm. 80x 70x 85h		⚡ 10,2 kW 230V~3 50/60 Hz	3.360,00 72 / 0,78
FMPE-25 35332530	cm. 80x 70x 85h		⚡ 10,2 kW 400V~3N 50/60 Hz	3.360,00 72 / 0,78
FMPEH-25 35332531	FRIGGITRICE PASTICCERIA POTENZIATA - 24 litri Vasca cm. 70x42,5x17,5h - 1 cesto cm. 67x35x8h Filtro e coperchio vasca - Bacinella raccogliolio con filtro EN Powerfull Confectioner's cabinet fryer - 24 liters - Tank cm. 70x42,5x17,5h 1 basket cm. 67x35x8h - Sieve and lid for tank - Drip tray with sieve • DE Friteuse leistungsfähiges für Konditorei mit Untergestell - 24 Liter - Becken cm. 70x42,5x17,5h 1 Korb cm. 67x35x8h - Einlegesieb mit Deckel für Becken - Fettauffangschale mit Sieb • FR Friteuse patisserie plus puissants - 24 litres - Cuve cm. 70x42,5x17,5h. 1 panier cm. 67x35x8h Filtre et couvercle pour cuve - Collecteur d'huile avec filtre • ES FREIDORA REPOSTERÍA CON MAYOR POTENCIA - 24 LITROS - CUBA CM. 70X42,5X17,5H - 1 CESTA CM. 67X35X8H FILTRO Y TAPA CUBA - BANDEJA RECOGE ACEITE CON FILTRO cm. 80x 70x 85h		⚡ 18 kW 400V~3N 50/60 Hz	3.569,00 72 / 0,78
FMPE-30 35333030	FRIGGITRICE PASTICCERIA TRIFASE - 31 litri Vasca cm. 90x42,5x17,5h - 1 cesto cm. 87x35x8h Filtro e coperchio vasca - Bacinella raccogliolio con filtro EN Confectioner's cabinet fryer threephase - 31 liters - Tank cm. 90x42,5x17,5h 1 basket cm. 87x35x8h - Sieve and lid for tank - Drip tray with sieve • DE Friteuse für Konditorei mit Untergestell dreiphasig - 31 Liter - Becken cm. 90x42,5x17,5h 1 Korb cm. 87x35x8h - Einlegesieb mit Deckel für Becken - Fettauffangschale mit Sieb • FR Friteuse patisserie triphase - 31 litres - Cuve cm. 90x42,5x17,5h. 1 panier cm. 87x35x8h Filtre et couvercle pour cuve - Collecteur d'huile avec filtre • ES FREIDORA REPOSTERÍA TRIFÁSICA - 31 LITROS - CUBA CM. 90X42,5X17,5H - 1 CESTA CM. 87X35X8H FILTRO Y TAPA CUBA - BANDEJA RECOGE ACEITE CON FILTRO cm. 100x 70x 85h		⚡ 13,2 kW 400V~3N 50/60 Hz	4.183,00 83 / 1,06
FMPG-20 40342050	FRIGGITRICE PASTICCERIA GAS - 20 litri Vasca cm. 50x38x24h - 1 cesto cm. 47x35x8h Filtro e coperchio vasca - Bacinella raccogliolio con filtro EN Confectioner's cabinet fryer gas - 20 liters Tank cm. 50x38x24h - 1 basket cm. 47x35x8h Sieve and lid for tank. Drip tray with sieve • DE Friteuse für Konditorei mit Untergestell gas - 20 Liter Becken cm. 50x38x24h - 1 Korb cm. 47x35x8h Sieb und Deckel für Becken - Fettauffangschale mit Sieb • FR Friteuse patisserie sur placard à gaz - 20 litres Cuve cm. 50x38x24h - 1 panier cm. 47x35x8h Filtre et couvercle pour cuve - Collecteur d'huile avec filtre • ES FREIDORA REPOSTERÍA EN MUEBLE A GAS - 20 LITROS CUBA CM. 50X38X24H - 1 CESTA CM. 47X35X8H FILTRO Y TAPA CUBA - BANDEJA RECOGE ACEITE CON FILTRO cm. 60x 70x 85h		⚡ 11,2 kW 9.630 kcal/h	3.807,00 68 / 0,78

FRIGGITRICI PASTICCERIA A GAS

MOD. _____
COD. _____

DESCRIZIONE/DESCRIPTION/BEZEICHNUNG/DESCRIPTION/DESCRIPCIÓN
DIMENSIONI/DIMENSIONS/ABMESSUNGEN/DIMENSIONS/DIMENSIONES

POTENZA/POWER/LEISTUNG/PUISSANCE/POTENCIA
VOLTAGGIO/VOLTAGE/SPANNUNG/VOLTAGE/VOLTAJE

kw kcal/h
kw V- Hz

PREZZO/PRICE €
PREIS/PRIX/PRECIO €
KG / M³

FMPG-30
40343050

FRIGGITRICE PASTICCERIA GAS - 28 litri Vasca cm. 70x38x24h - 1 cesto cm. 67x35x8h - Filtro e coperchio vasca - Bacinella raccogliolio con filtro
EN Confectioner's cabinet fryer gas - 28 liters - Tank cm. 70x38x24h - 1 basket cm. 67x35x8h Sieve and lid for tank. Drip tray with sieve
• **DE** Friteuse für Konditorei mit Untergestell gas - 28 Liter - Becken cm. 70x38x24h - 1 Korb cm. 67x35x8h Sieb und Deckel für Becken - Fettauffangschale mit Sieb
• **FR** Friteuse patisserie sur placard à gaz - 28 litres - Cuve cm. 70x38x24h - 1 panier cm. 67x35x8h Filtre et couvercle pour cuve - Collecteur d'huile avec filtre
• **ES FREIDORA REPOSTERÍA EN MUEBLE A GAS - 28 LITROS - CUBA CM. 70X38X24H - 1 CESTA CM. 67X35X8H FILTRO Y TAPA CUBA - BANDEJA RECOGE ACEITE CON FILTRO**
cm. 80x 70x 85h



16,5 kW
14.190 kcal/h
4.368,00
84 / 1,06

40280600

SCIVOLO inox 60
EN Stainless slide 60 • **DE** Rutsche aus Rostfreiem Stahl 60 • **FR** Goulotte en acier inox 60 • **ES DESLIZADOR INOX 60**
cm. 38x 55x 27h

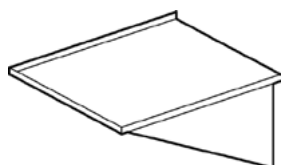

154,00
4 / 0,07

40280800

SCIVOLO inox 80 / F45
EN Stainless steel slide 80 / F45 • **DE** Rutsche aus Rostfreiem Stahl 80 / F45 • **FR** Goulotte en acier inox 80 / F45 • **ES DESLIZADOR INOX 80 / F45**
cm. 38x 75x 27h

170,00
5 / 0,09

40281000

SCIVOLO inox 100
EN Stainless steel slide 100 • **DE** Rutsche aus Rostfreiem Stahl 100
• **FR** Goulotte en acier inox 100 • **ES DESLIZADOR INOX 100**
cm. 38x 95x 27h

195,00
6 / 0,12

40290800

MITRA 800
EN Chimney jack 800 • **DE** Lüftungsaufsatz 800 • **FR** Mitre 800 • **ES CAPERUZA 800**

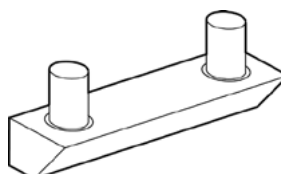

683,00
9 / 0,04





CA-11
40290110

CAMINO ANTIVENTO (Obbligatorio per FPG-30, FMPG-30, in Germania, Olanda e Austria: Mitra per estrazione forzata fumi combusti. Mitra + camino antivento per estrazione naturale fumi combusti.)
EN Draught diverter (Obligatory for FPG-30, FMPG-30, in Germany, Holland and Austria: Chimney jack for forced extraction of burnt smoke. Chimney jack + draught diverter for natural extraction of burnt smoke.)
• **DE** Strömungssicherung (Pflicht für FPG-30, FMPG-30, in Deutschland, Holland e Österreich: Lüftungsaufsatz zur erzwungenen Wrasenabführung. Lüftungsaufsatz + Strömungssicherung zur natürlichen Wrasenabführung.)
• **FR** Cheminee anti-vent (Obligatoire pour FPG-30, FMPG-30 en Allemagne, Hollande et Autriche: Mitre pour sortie forcée des fumées brûlées. Mitre + cheminee anti-vent pour sortie naturelle des fumées brûlées.)
• **ES CHIMENEA CONTRA VIENTO (OBLIGATORIO PARA FPG-30, FMPG-30 EN ALEMANIA, HOLANDA Y AUSTRIA CAPERUZA PARA LA EXTRACCIÓN FORZADA DE HUMOS DE COMBUSTIÓN. CAPERUZA + CHIMENEA CONTRA VIENTO PARA LA EXTRACCIÓN NATURAL DE HUMOS DE COMBUSTIÓN.)**
cm. Ø 11

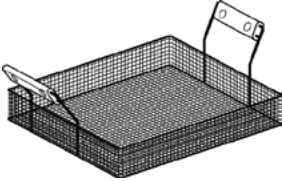

324,00
5 / 0,01

FRIGGITRICI PASTICCERIA 45 LT



MOD. COD.	DESCRIZIONE/DESCRIPTION/BEZEICHNUNG/DESCRIPTION/DESCRIPCIÓN DIMENSIONI/DIMENSIONS/ABMESSUNGEN/DIMENSIONS/DIMENSIONES	POTENZA/POWER/LEISTUNG/PUISSANCE/POTENCIA VOLTAGGIO/VOLTAGE/SPANNUNG/VOLTAGE/VOLTAGE	⚡ kW kcal/h	⚡ kw V~ Hz	PREZZO/PRICE PREIS/PRIX/PRECIO €/ M ³
F45-78ET 08090835	FRIGGITRICE TRIFASE LT. 45 Vasca cm. 70x38x38h - 1 cesto cm. 65x33x17h - Filtro e coperchio vasca. Bacinella raccogliolio con filtro. Produzione patate: 40 kg/h (inclusa 1 testata chiusura piano mod.TPA-7) EN Fryer threephase 45 lts - Bowl cm. 70x38x38h - 1 basket cm. 65x33x17h. Sieve and lid for pan. Drip tray with sieve. Production: 40 kg/h (included 1 Head end filler strip mod.TPA-7) • DE Friteuse dreiphasig lt. 45 - Becken cm. 70x38x38h - 1 Korb cm. 65x33x17h. Einlegesieb und Deckel für Becken. Fettauffangschale mit Sieb. Pommes frites: 40 kg/h (inbegriffen 1 Abschluss-Element mod.TPA-7) • FR Friteuse triphase lt. 45 - Cuve cm. 70x38x38h - 1 Panier cm. 65x33x17h. Filtre, couvercle pour cuve. Bac de récupération de l'huile avec filtre. Production de pommes frites: 40 kg/h (inclus 1 Élément de jonction top mod.TPA-7) • ES FREIDORAS TRIFÁSICO 45 LT. - CUBA CM. 70X38X38H - 1 CESTA CM. 65X33X17H. FILTRO Y TAPA PARA CUBA. BANDEJA RECOGE ACEITE CON FILTRO. PROD. PATATAS: 40 KG/H (INCLUIDA 1 CHAPA DE CIERRE PARA TOP MOD.TPA-7) cm. 80x 70,5x 90h		⚡ 40 kW 400V~3N 50/60 Hz		5.109,00 96 / 0,71
F45-78G 08260855	FRIGGITRICE GAS LT. 45 Vasca cm. 70x38x38h. - 1 cesto cm. 65x33x17h. Filtro e coperchio vasca. Bacinella raccogliolio con filtro. Prod. patate: 40 kg/h (include entrambe le testate chiusura piano) EN Gas Fryer 45 lts - Bowl cm. 70x38x38h - 1 basket cm. 65x33x17h. Sieve and lid for pan. Drip tray with sieve. Production: 40 kg/h (included both Heads end filler strip) • DE Gas-Friteuse lt. 45 - Becken cm. 70x38x38h - 1 Korb cm. 65x33x17h. Einlegesieb und Deckel für Becken. Fettauffangschale mit Sieb. Pommes frites: 40 kg/h (inbegriffen alle 2 Abschluss-Element) • FR Friteuse a gaz lt. 45 - Cuve cm. 70x38x38h - 1 Panier cm. 65x33x17h. Filtre, couvercle pour cuve. Bac de récupération de l'huile avec filtre. Production de pommes frites: 40 kg/h (inclus tous 2 Élément de jonction top) • ES FREIDORAS A GAS 45 LT. - CUBA CM. 70X38X38H - 1 CESTA CM. 65X33X17H. FILTRO Y TAPA PARA CUBA. BANDEJA RECOGE ACEITE CON FILTRO. PROD. PATATAS: 40 KG/H (INCLUIDAS TODAS LAS 2 CHAPA DE CIERRE PARA TOP) cm. 80x 70,5x 90h		⚡ 44 kW 37.840 kcal/h	⚡ 0,005 KW 230V~ 50 Hz	6.071,00 110 / 1,07
531033300	CESTO 1/1 F45 EN Basket 1/1 F45 • DE korb 1/1 F45 • FR Panier 1/1 F45 • ES CESTA 1/1 F45 cm. 65x 33x 17h				219,00 3 / 0,10
531041300	CESTO 1/2 F45 EN Basket 1/2 F45 • DE korb 1/2 F45 • FR Panier 1/2 F45 • ES CESTA 1/2 F45 cm. 28x 29x 15h				91,00 1.5 / 0,06
531047800	CESTO 1/3 F45 EN Basket 1/3 F45 • DE korb 1/3 F45 • FR Panier 1/3 F45 • ES CESTA 1/3 F45 cm. 21,5x 33x 16,5h				107,00 1.3 / 0,06

ACCESSORI PASTICCERIA

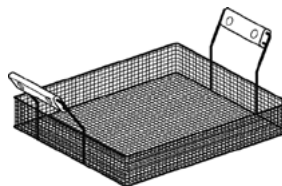
MOD. COD.	DESCRIZIONE/DESCRIPTION/BEZEICHNUNG/DESCRIPTION/DESCRIPCIÓN DIMENSIONI/DIMENSIONS/ABMESSUNGEN/DIMENSIONS/DIMENSIONES	POTENZA/POWER/LEISTUNG/PUISSANCE/POTENCIA VOLTAGGIO/VOLTAGE/SPANNUNG/VOLTAGE/VOLTAJE	$\frac{\text{kW}}{\text{kcal/h}}$ $\frac{\text{kw}}{\text{V}\cdot\text{Hz}}$	PREZZO/PRICE PREIS/PRIX/PRECIO € KG / M ³
531017500	CESTINO 60 EN Basket 60 • DE Fritierkorb 60 • FR Panier 60 • ES CESTA 60 cm. 47x 35x 8h			134,00 1.5 / 0,06
531016900	CESTINO 80 EN Basket 80 • DE Fritierkorb 80 • FR Panier 80 • ES CESTA 80 cm. 67x 35x 8h			139,00 2 / 0,08
531017700	CESTINO 100 EN Basket 100 • DE Fritierkorb 100 • FR Panier 100 • ES CESTA 100 cm. 87x 35x 8h			211,00 2.5 / 0,10
531036700	RETE CON MANIGLIA 60 EN grid with handle 60 • DE Raster mit Griff 60 • FR grille avec poignée 60 • ES GRID CON ASA 60 cm. 43x 31x 22h			132,00 1 / 0,03
531036800	RETE CON MANIGLIA 80 EN grid with handle 80 • DE Raster mit Griff 80 • FR grille avec poignée 80 • ES GRID CON ASA 80 cm. 63x 31x 22h			134,00 1.5 / 0,05
531036900	RETE CON MANIGLIA 100 EN grid with handle 100 • DE Raster mit Griff 100 • FR grille avec poignée 100 • ES GRID CON ASA 100 cm. 83x 31x 22h			137,00 2 / 0,06
F-1G 20029500	FORNELLONE A PAVIMENTO EN Gas stove • DE Gas-hocherkocker 1 flammig • FR Rechaud a gaz • ES HORNO A PAVIMENTO cm. 44x 57x 24h		$\frac{9,5 \text{ kW}}{8.170 \text{ kcal/h}}$	602,00 10 / 0,14
FB-1G 20029550	cm. 64x 76x 50h		$\frac{9,5 \text{ kW}}{8.170 \text{ kcal/h}}$	800,00 15 / 0,53
FO-1G 20029501	FORNELLONE 1 FUOCO GAS EN Gas table-top stove - 1 burner • DE Gaskocher - 1 Kochstelle • FR Rechaud a gaz, 1 feu • ES HORNO 1 QUEMADOR GAS cm. 40x 60x 25h		$\frac{5,5 \text{ kW}}{4.730 \text{ kcal/h}}$	890,00 13 / 0,13
FO-2G 20029502	FORNELLONE 2 FUOCHI GAS EN Gas table-top stove - 2 burners • DE Gaskocher, 2 Kochstellen • FR Rechaud a gaz, 2 feux • ES HORNO 2 QUEMADORES GAS cm. 70x 60x 25h		$\frac{9 \text{ kW}}{7.740 \text{ kcal/h}}$	1.399,00 22 / 0,22



FORNELLONI PASTICCERIA

MOD. COD.	DESCRIZIONE/DESCRIPTION/BEZEICHNUNG/DESCRIPTION/DESCRIPCIÓN DIMENSIONI/DIMENSIONS/ABMESSUNGEN/DIMENSIONS/DIMENSIONES	POTENZA/POWER/LEISTUNG/PUISSANCE/POTENCIA VOLTAGGIO/VOLTAGE/SPANNUNG/VOLTAGE/VOLTAJE	$\frac{kW}{kcal/h}$ $\frac{V}{Hz}$	PREZZO/PRICE € KG / M ³
FO-3G 20029503	FORNELLONE 3 FUOCHI GAS EN Gas table-top stove, 3 burners • DE Gaskocher, 3 Kochstellen • FR Rechaud a gaz, 3 feux • ES HORNO 3 QUEMADORES GAS cm. 105x 60x 25h		$\frac{14,5 kW}{12.470 kcal/h}$	1.955,00 35 / 0,32
				
KIT-FO-1FT 20029535	KIT GRIGLIA IN TONDINO 1 FUOCO PER FO-.. EN KIT grid rod 1 burner FO-.. • DE KIT Gitterstab 1 Brenner FO-.. • FR KIT tige grille 1 feux FO-.. • ES KIT RED DE VARILLA 1 QUEMADOR FO-..			166,00 3 / 0,01
				
CF-1 20029511	CAVALLETTO INOX per FO/1G EN Stainless steel stand for FO/1G • DE Untergestell für FO/1G • FR Support en acier inox pour FO/1G • ES SOPORTE INOX PARA FO/1G cm. 40x 50x 60h			513,00 17 / 0,18
				
CF-2 20029512	CAVALLETTO INOX per FO/2G EN Stainless steel stand for FO/2G • DE Untergestell für FO/2G • FR Support en acier inox pour FO/2G • ES SOPORTE INOX PARA FO/2G cm. 70x 50x 60h			676,00 23 / 0,35
				
CF-3 20029513	CAVALLETTO INOX per FO/3G EN Stainless steel stand for FO/3G • DE Untergestell für FO/3G • FR Support en acier inox pour FO/3G • ES SOPORTE INOX PARA FO/3G cm. 105x 50x 60h			770,00 29 / 0,43
				
AF-1 20029521	ARMADIETTO con porte per FO-1G EN Cabinet with wing doors for FO/1G • DE Unterschrank mit Flügeltüren für FO/1G • FR Placard avec portes pour FO/1G • ES PEQUEÑO ARMARIO CON PUERTAS PARA FO/1G cm. 40x 53x 60h			752,00 27 / 0,18
				
AF-2 20029522	ARMADIETTO con porte per FO-2G EN Cabinet with wing doors for FO/2G • DE Unterschrank mit Flügeltüren für FO/2G • FR Placard avec portes pour FO/2G • ES PEQUEÑO ARMARIO CON PUERTAS PARA FO/2G cm. 70x 53x 60h			1.094,00 33 / 0,35
				
AF-3 20029523	ARMADIETTO con porte per FO-3G EN Cabinet with wing doors for FO/3G • DE Unterschrank mit Flügeltüren für FO/3G • FR Placard avec portes pour FO/3G • ES PEQUEÑO ARMARIO CON PUERTAS PARA FO/3G cm. 105x 53x 60h			1.669,00 39 / 0,43
				
PLFO 20029531	PIASTRA LISCIA FORNELLONE EN Smooth griddle plate for gas stove • DE Fortkochplatte glatt für Gaskocher • FR Plaque lisse pour rechaud • ES PLANCHA LISA PARA HORNO cm. 35x 37			246,00 10 / 0,02
				
PRFO 20029533	PIASTRA RIGATA FORNELLONE EN Grooved griddle plate for gas stove • DE Fortkochplatte gerillt für Gaskocher • FR Plaque rainurée para rechaud • ES PLANCHA ESTRIADA PARA HORNO cm. 35x 37			293,00 10 / 0,02
				

FORNELLONI PASTICCERIA

MOD. _____ COD. _____	DESCRIZIONE/DESCRIPTION/BEZEICHNUNG/DESCRIPTION/DESCRIPCIÓN DIMENSIONI/DIMENSIONS/ABMESSUNGEN/DIMENSIONS/DIMENSIONES	POTENZA/POWER/LEISTUNG/PUISSANCE/POTENCIA VOLTAGGIO/VOLTAGE/SPANNUNG/VOLTAGE/VOLTAJE	<table border="0" style="font-size: small;"> <tr> <td>⚡ kW</td> <td>↗ kW</td> </tr> <tr> <td>kcal/h</td> <td>V~</td> </tr> <tr> <td></td> <td>Hz</td> </tr> </table>	⚡ kW	↗ kW	kcal/h	V~		Hz	PREZZO/PRICE PREIS/PRIX/PRECIO € KG / M ³
⚡ kW	↗ kW									
kcal/h	V~									
	Hz									

544439900 ANELLO PER WOK
EN Wok ring • **DE** Wok Aufsatzring • **FR** Anneau Wok • **ES**
ANILLO WOK
 cm. Ø 22,5x 3,5h



170,00
2 / 0,00

Lista de precios.

Sistemas de cocción y accesorios.



España, 01.04.2023

Indicaciones y aclaraciones importantes

Este catálogo tiene validez solo en España y Andorra. El precio mencionado es el precio de venta al público recomendado de RATIONAL Ibérica, no incluye el impuesto sobre el valor añadido y es aplicable a partir del 01.04.2023. Todos los catálogos anteriores dejarán de ser válidos. Nos reservamos el derecho a efectuar modificaciones técnicas conforme a los últimos avances, así como modificaciones en el precio y el número del artículo.

Todos los equipos de RATIONAL ofrecen una garantía de 2 años para los equipos nuevos a partir de la fecha de facturación real o la fecha de instalación de mostrada. La fecha de instalación debe justificarse con la factura de la instalación o la confirmación por escrito del distribuidor y el agente comercial. Se aplicarán las condiciones recogidas en la declaración de garantía de RATIONAL. Le informaremos con gusto acerca del alcance del equipamiento especial y otras posibilidades de equipamiento individuales.

Obtendrá más información en rational-online.com, por teléfono: 93 4751750 o e-mail: info@rational-online.es

● Equipamiento de serie sin recargo | ○ Equipamiento especial pagando un recargo | – No disponible | □ Accesorios

Índice



- 432** iCombi Pro
- 434** iCombi Classic
- 436** Opciones para iCombi Pro e iCombi Classic
- 440** Combi-Duo
- 440** Combi-Duo XS 6-2/3
- 442** Combi-Duo 6-1/1 y 10-1/1
- 443** Combi-Duo 6-2/1 y 10-2/1
- 445** Productos de limpieza del iCombi
- 446** Accesorios
- 446** Accesorios tipo XS 6-2/3
- 448** Accesorios tipo 6-1/1 y 10-1/1
- 453** Accesorios tipo 6-2/1 y 10-2/1
- 457** Accesorios tipo 20-1/1 y 20-2/1
- 460** Accesorios para la cocción y accesorios especiales
- 463** Contenedores Gastronorm
- 464** Paquetes de compatibilidad iCombi
- 466** Paquetes de compatibilidad de Combi-Duo universal
- 467** Símbolo de homologación para iCombi
- 468** Características del equipamiento iCombi

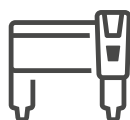

- 475** iVario
- 477** iVario Pro
- 478** Opciones iVario
- 480** Variantes de montaje para iVario 2-XS e iVario Pro 2-S
- 481** Variantes de montaje para iVario Pro L e iVario Pro XL
- 482** Accesorios
- 482** Accesorios tipo 2-XS
- 484** Accesorios tipo 2-S
- 487** Accesorios tipo L, XL
- 488** Productos de limpieza del iVario
- 489** Opciones de adaptación para iVario 2-XS, iVario Pro 2-S, L e XL
- 492** Características del equipamiento iVario
- 494** Símbolo de homologación para iVario



- 495** ConnectedCooking

iCombi Pro



	XS 6-2/3	6-1/1	10-1/1
Versión eléctrica	8.580€	10.730€	15.090€
Referencia de artículo	CA1ERRA.0000816	CB1ERRA.0000817	CD1ERRA.0000818
Potencia de conexión	5,7 kW	10,8 kW	18,9 kW
Tensión de alimentación	3 NAC 400 V	3 NAC 400 V	3 NAC 400 V
Peso	62 kg	100 kg	130 kg
Versión para gas	-	12.800€	17.500€
Número de artículo para Gas Natural H G20	-	CB1GRRRA.0000842	CD1GRRRA.0000843
Número de artículo para Gas GLP 3B/P	-	CB1GRRRA.0000836	CD1GRRRA.0000837
Potencia de conexión para Gas Natural H G20	-	13 kW	22 kW
Potencia de conexión para Gas GLP 3B/P	-	13,5 kW	23 kW
Tensión de alimentación	-	1 NAC 230 V	1 NAC 230 V
Peso	-	114 kg	149 kg
Capacidad	6 × 2/3 GN	6 × 1/1 GN / 12 × 1/2 GN	10 × 1/1 GN / 20 × 1/2 GN
Número de comidas por día	20–80	30–100	80–150
Ancho	655 mm	850 mm	850 mm
Profundidad (con maneta de la puerta)	555 mm (621 mm)	775 mm (842 mm)	775 mm (842 mm)
Altura (con tubo de ventilación)	567 mm (594 mm)	754 mm (804 mm)	1014 mm (1064 mm)
Opciones			
Apertura inversa para la puerta de la cámara de cocción	418€	418€	418€
Paquete de racks móviles	-	361€	439€
Drenaje de grasa integrado	-	837€	837€
MarineLine	579€	859€	859€
HeavyDutyLine	-	617€	617€
SecurityLine	-	1.253€	1.253€
Cierre de seguridad para la puerta	73€	73€	73€
Panel de control cerrable	-	624€	624€
UltraVent montada	3.551€	-	-
Campana UltraVent Plus montada	5.442€	-	-
Conexión a un sistema de optimización de energía	74€	74€	74€
Conexión al indicador de operaciones	74€	74€	74€

Accesorios

Aquí encontrará el accesorio adecuado:	Página [18]	Página [20]	Página [20]
--	-------------	-------------	-------------

Encontrará más información y opciones en la página [8] y nuestro sitio web. Además, obtendrá información sobre la combinación de opciones y los voltajes especiales previa solicitud.



6-2/1	10-2/1	20-1/1	20-2/1
16.390€	21.800€	25.520€	36.580€
CC1ERRA.0000819	CE1ERRA.0000820	CF1ERRA.0000821	CG1ERRA.0000822
22,4 kW	37,4 kW	37,2 kW	67,9 kW
3 NAC 400 V	3 NAC 400 V	3 NAC 400 V	3 NAC 400 V
135 kg	173 kg	254 kg	325 kg
19.020€	25.290€	28.830€	41.330€
CC1GRRRA.0000844	CE1GRRRA.0000845	CF1GRRRA.0000846	CG1GRRRA.0000847
CC1GRRRA.0000838	CE1GRRRA.0000839	CF1GRRRA.0000840	CG1GRRRA.0000841
28 kW	40 kW	42 kW	80 kW
29,5 kW	42 kW	44 kW	84 kW
1 NAC 230 V	1 NAC 230 V	1 NAC 230 V	1 NAC 230 V
151 kg	192 kg	273 kg	358 kg
6 × 2/1 GN / 12 × 1/1 GN	10 × 2/1 GN / 20 × 1/1 GN	20 × 1/1 GN / 40 × 1/2 GN	20 × 2/1 GN / 40 × 1/1 GN
60–160	150–300	150–300	300–500
1072 mm	1072 mm	877 mm	1082 mm
975 mm (1042 mm)	975 mm (1042 mm)	847 mm (913 mm)	1052 mm (1117 mm)
754 mm (804 mm)	1014 mm (1064 mm)	1807 mm (1872 mm)	1807 mm (1872 mm)
418€	418€	–	–
504€	608€	–	–
837€	837€	3.539€	3.539€
859€	859€	1.166€	1.166€
617€	617€	1.278€	1.328€
1.253€	1.253€	2.848€	2.848€
73€	73€	184€	184€
624€	624€	624€	624€
–	–	–	–
–	–	–	–
74€	74€	74€	74€
74€	74€	74€	74€
Página [25]	Página [25]	Página [29]	Página [29]

iCombi Classic



	6-1/1	10-1/1
Versión eléctrica	8.440€	11.860€
Referencia de artículo	CB2ERRA.0000824	CD2ERRA.0000825
Potencia de conexión	10,8 kW	18,9 kW
Tensión de alimentación	3 NAC 400 V	3 NAC 400 V
Peso	95 kg	123 kg
Versión para gas	10.060€	13.760€
Número de artículo para Gas Natural H G20	CB2GRRRA.0000860	CD2GRRRA.0000861
Número de artículo para Gas GLP 3B/P	CB2GRRRA.0000854	CD2GRRRA.0000855
Potencia de conexión para Gas Natural H G20	13 kW	22 kW
Potencia de conexión para Gas GLP 3B/P	13,5 kW	23 kW
Tensión de alimentación	1 NAC 230 V	1 NAC 230 V
Peso	110 kg	143 kg
Capacidad	6 × 1/1 GN / 12 × 1/2 GN	10 × 1/1 GN / 20 × 1/2 GN
Número de comidas por día	30–100	80–150
Ancho	850 mm	850 mm
Profundidad (con maneta de la puerta)	775 mm (842 mm)	775 mm (842 mm)
Altura (con tubo de ventilación)	754 mm (804 mm)	1014 mm (1064 mm)
Opciones		
Apertura inversa para la puerta de la cámara de cocción	418€	418€
Paquete de racks móviles	361€	439€
Drenaje de grasa integrado	837€	837€
MarineLine	859€	859€
HeavyDutyLine	617€	617€
SecurityLine	1.253€	1.253€
Cierre de seguridad para la puerta	73€	73€
Panel de control cerrable	624€	624€
UltraVent montada	–	–
Campana UltraVent Plus montada	–	–
Conexión a un sistema de optimización de energía	74€	74€
Conexión al indicador de operaciones	74€	74€

Accesorios

Aquí encontrará el accesorio adecuado: Página [20] Página [20]

Encontrará más información y opciones en la página [8] y nuestro sitio web. Además, obtendrá información sobre la combinación de opciones y los voltajes especiales previa solicitud.



6-2/1	10-2/1	20-1/1	20-2/1
12.890€	17.140€	21.940€	31.440€
CC2ERRA.0000826	CE2ERRA.0000827	CF2ERRA.0000828	CG2ERRA.0000829
22,4 kW	37,4 kW	37,2 kW	67,9 kW
3 NAC 400 V	3 NAC 400 V	3 NAC 400 V	3 NAC 400 V
128 kg	165 kg	246 kg	313 kg
14.950€	19.870€	24.780€	35.530€
CC2GRRRA.0000862	CE2GRRRA.0000863	CF2GRRRA.0000864	CG2GRRRA.0000865
CC2GRRRA.0000856	CE2GRRRA.0000857	CF2GRRRA.0000858	CG2GRRRA.0000859
28 kW	40 kW	42 kW	80 kW
29,5 kW	42 kW	44 kW	84 kW
1 NAC 230 V	1 NAC 230 V	1 NAC 230 V	1 NAC 230 V
147 kg	187 kg	267 kg	346 kg
6 × 2/1 GN / 12 × 1/1 GN	10 × 2/1 GN / 20 × 1/1 GN	20 × 1/1 GN / 40 × 1/2 GN	20 × 2/1 GN / 40 × 1/1 GN
60–160	150–300	150–300	300–500
1072 mm	1072 mm	877 mm	1082 mm
975 mm (1042 mm)	975 mm (1042 mm)	847 mm (913 mm)	1052 mm (1117 mm)
754 mm (804 mm)	1014 mm (1064 mm)	1807 mm (1872 mm)	1807 mm (1872 mm)
418€	418€	–	–
504€	608€	–	–
837€	837€	3.539€	3.539€
859€	859€	1.166€	1.166€
617€	617€	1.278€	1.328€
1.253€	1.253€	2.848€	2.848€
73€	73€	184€	184€
624€	624€	624€	624€
–	–	–	–
–	–	–	–
74€	74€	74€	74€
74€	74€	74€	74€

Página [25]

Página [25]

Página [29]

Página [29]

ENERGY STAR está disponible para los sistemas de cocción 6-1/1 y 6-2/1 en versión eléctrica y de gas, además de versión 10-1/1 eléctrica.

Opciones para iCombi Pro e iCombi Classic



Apertura inversa de la puerta de la cámara de cocción en equipos de sobremesa

Para facilitar el acceso al sistema de cocción en determinadas cocinas, se puede encargar la puerta del equipo de sobremesa con apertura inversa.

	XS 6-2/3	6-1/1	10-1/1	6-2/1	10-2/1	20-1/1	20-2/1
iCombi Pro	418€	418€	418€	418€	418€	–	–
iCombi Classic	–	418€	418€	418€	418€	–	–



Paquete de rack móvil para equipos de sobremesa

Los bastidores se sustituyen por un rack intercambiable con guía de inserción. Encontrará carros de transporte adecuados para la carga y descarga cómoda y segura de su sistema de cocción en la página [22] y la página [26].

Características:

- > Rack móvil para el accesorio Gastronorm o de medidas de panadería (distintos racks móviles con varios números de bandejas disponibles)
- > Guía de inserción estándar para carro de transporte de equipos de sobremesa

	XS 6-2/3	6-1/1	10-1/1	6-2/1	10-2/1	20-1/1	20-2/1
iCombi Pro	–	361€	439€	504€	608€	–	–
iCombi Classic	–	361€	439€	504€	608€	–	–



Paquete de racks móviles para Combi-Duo

Los bastidores se sustituyen por un rack intercambiable con guía de inserción. Encontrará carros de transporte adecuados para la carga y descarga cómoda y segura de su Combi-Duo en la página [14], página [22] así como en la página [16] y página [26].

Características: (configurar según el sistema de cocción)

- > Rack móvil para el accesorio Gastronorm o de medidas de panadería (distintos racks móviles con varios números de bandejas disponibles)
- > Guía de inserción para carro de transporte Combi-Duo

	XS 6-2/3	6-1/1	10-1/1	6-2/1	10-2/1	20-1/1	20-2/1
iCombi Pro	–	361€	439€	504€	608€	–	–
iCombi Classic	–	361€	439€	504€	608€	–	–



Drenaje de grasa integrado

La grasa generada se desviará automáticamente de la cámara de cocción hasta un recipiente colector de grasa especial. Para utilizar la opción en los sistemas de cocción del tipo 6-1/1, 10-1/1, 6-2/1, 10-2/1 1 hay que utilizar accesorios: es necesario una mesa II, una mesa IV o un kit de nivelación.

Características:

- > Componentes básicos: Recipiente colector de grasa, sistema de tuberías y recipiente colector
- > Los componentes específicos aparecen en el archivo: drenaje de grasa integrado

	XS 6-2/3	6-1/1	10-1/1	6-2/1	10-2/1	20-1/1	20-2/1
iCombi Pro	–	837€	837€	837€	837€	3.539€	3.539€
iCombi Classic	–	837€	837€	837€	837€	3.539€	3.539€

Accesorio para el drenaje de grasa integrado

60.73.309	Carro de transporte para contenedores con drenaje de grasa integrado (Combi-Duo y equipos de suelo)	521€
-----------	---	------

Opciones para iCombi Pro e iCombi Classic



MarineLine para equipos eléctricos

Permite el manejo eficiente y seguro de su sistema de cocción en barcos.

Características:

- › Seguro antideslizamiento y antivuelco de los equipos de sobremesa (tipos XS 6-2/3, 6-1/1, 10-1/1, 6-2/1, 10-2/1) al atornillarlos con mesas que pueden fijarse. Las mesas disponibles se encuentran en la página [18], la página [20] y la página [25]
- › Las patas de acero inoxidable y el kit de fijación adicional permiten atornillar o soldar los equipos de sobremesa (tipos 20-1/1, 20-2/1) y, con ello, asegurarlos frente a vuelcos y deslizamientos
- › Tope para puerta flexible y ajustable para amortiguar el movimiento de apertura y cierre de la puerta, así como para fijarla en posición abierta
- › Los bastidores colgantes y los racks móviles especialmente diseñados impiden que el accesorio de cocción empleado se salga
- › Conforme a los requisitos sanitarios del USPHS (servicio de salud pública estadounidense)
- › Certificado por Germanischer Lloyd

	XS 6-2/3	6-1/1	10-1/1	6-2/1	10-2/1	20-1/1	20-2/1
iCombi Pro	579€	859€	859€	859€	859€	1.166€	1.166€
iCombi Classic	–	859€	859€	859€	859€	1.166€	1.166€

Accesorio MarineLine

60.76.348	Rejilla de protección lateral para puerta de apertura hacia la derecha, tipo 6-1/1	456€
60.76.350	Rejilla de protección lateral para puerta de apertura inversa, tipo 6-1/1	456€
60.76.353	Rejilla de protección lateral para puerta de apertura hacia la derecha, tipo 10-1/1	548€
60.76.355	Rejilla de protección lateral para puerta de apertura inversa, tipo 10-1/1	548€
60.76.351	Rejilla de protección lateral para puerta de apertura hacia la derecha, tipo 6-2/1	570€
60.76.352	Rejilla de protección lateral para puerta de apertura inversa, tipo 6-2/1	570€
60.76.356	Rejilla de protección lateral para puerta de apertura hacia la derecha, tipo 10-2/1	662€
60.76.412	Rejilla de protección lateral para puerta de apertura inversa, tipo 10-2/1	662€
60.76.413	Rejilla de protección lateral para puerta, tipo 20-1/1	753€
60.76.414	Rejilla de protección lateral para puerta, tipo 20-2/1	981€

SecurityLine

Los elementos de seguridad específicos protegen el sistema de cocción frente a la destrucción intencionada y evitan que se use para lesionar a las personas. Solo para sistemas de cocción con puerta de apertura hacia la derecha.

Características:

- › Panel de control cerrable
- › Puerta de cámara de cocción cerrable en el tipo de seguridad con rejilla de acero integrada
- › Racks móviles con asidero abatible para tipos 20-1/1 y 20-2/1
- › Ducha de mano cerrable y cajón Care para tipos 20-1/1 y 20-2/1

	XS 6-2/3	6-1/1	10-1/1	6-2/1	10-2/1	20-1/1	20-2/1
iCombi Pro	–	1.253€	1.253€	1.253€	1.253€	2.848€	2.848€
iCombi Classic	–	1.253€	1.253€	1.253€	1.253€	2.848€	2.848€

Cierre de seguridad para la puerta

El cierre de seguridad de la puerta evita la apertura demasiado rápida de la puerta de cocción y evita, con ello, las lesiones provocadas por la salida de vapor caliente.

Características:

- › Apertura de la cámara de cocción de los equipos de sobremesa accionando dos veces el asa de la puerta
- › Apertura de la cámara de cocción de los equipos de suelo mediante el accionamiento del pedal adicional

	XS 6-2/3	6-1/1	10-1/1	6-2/1	10-2/1	20-1/1	20-2/1
iCombi Pro	73€	73€	73€	73€	73€	184€	184€
iCombi Classic	–	73€	73€	73€	73€	184€	184€



Opciones para iCombi Pro e iCombi Classic



Panel de control cerrable

Protege del acceso no autorizado y la destrucción intencionada con una cubierta de plástico prácticamente indestructible (LEXAN) con cerradura integrada. Solo para sistemas de cocción con puerta de apertura hacia la derecha.

	XS 6-2/3	6-1/1	10-1/1	6-2/1	10-2/1	20-1/1	20-2/1
iCombi Pro	-	624€	624€	624€	624€	624€	624€
iCombi Classic	-	624€	624€	624€	624€	624€	624€



HeavyDutyLine

Diseñados para el uso en condiciones exigentes, como temperaturas altas, muchas horas de servicio y grandes esfuerzos mecánicos, los sistemas de cocción del tipo HeavyDutyLine están a la altura de las exigencias de las grandes cocinas.

Características:

- › Elemento/s metálico/s para proteger el panel de control, la rueda de ajuste, etc.
- › Rack móvil reforzado para los tipos 20-1/1 y 20-2/1
- › Una sonda térmica USB externa (se suprime la sonda térmica interna)
- › Preparado para ampliar la protección lateral de la puerta y las paredes laterales con accesorios adicionales

	XS 6-2/3	6-1/1	10-1/1	6-2/1	10-2/1	20-1/1	20-2/1
iCombi Pro	-	617€	617€	617€	617€	1.278€	1.328€
iCombi Classic	-	617€	617€	617€	617€	1.278€	1.328€

Accesorio HeavyDutyLine

60.76.106	Protección lateral 6-1/1, 10-1/1. Solo en combinación con la mesa II	1.261€
60.76.354	Protección lateral 6-2/1, 10-2/1. Solo en combinación con la mesa II	1.576€
60.76.367	Protección lateral izquierda 20-1/1	756€
60.76.361	Protección lateral derecha 20-1/1	756€
60.76.292	Protección lateral izquierda 20-2/1	908€
60.76.112	Protección lateral derecha 20-2/1	908€
60.76.348	Rejilla de protección lateral para puerta de apertura hacia la derecha, tipo 6-1/1	456€
60.76.353	Rejilla de protección lateral para puerta de apertura hacia la derecha, tipo 10-1/1	548€
60.76.351	Rejilla de protección lateral para puerta de apertura hacia la derecha, tipo 6-2/1	570€
60.76.356	Rejilla de protección lateral para puerta de apertura hacia la derecha, tipo 10-2/1	662€
60.76.413	Rejilla de protección lateral para puerta, tipo 20-1/1	753€
60.76.414	Rejilla de protección lateral para puerta, tipo 20-2/1	981€

MobilityLine

Accesorio especial para empleo móvil en catering de eventos o banquetes.

Características:

- › Para equipos de sobremesa tipos 6-1/1, 10-1/1, 6-2/1 y 10-2/1: Mesa II MobilityLine con 14 pares de carriles de soporte. Abierta por ambos lados, con paneles laterales, refuerzo lateral. Cuatro ruedas de acero inoxidable con 200 mm. Edición con asas con protección lateral
- › Para equipos de sobremesa tipos 20-1/1 y 20-2/1. Bastidor de base móvil con 4 ruedas de acero inoxidable y freno

60.31.164	Mesa II, Versión MobilityLine tipo 6-1/1, 10-1/1	2.737€
60.31.165	Mesa II, Versión MobilityLine tipo 6-2/1, 10-2/1	3.120€
60.21.334	Bastidor de base móvil 20-1/1	2.863€
60.22.496	Bastidor de base móvil 20-2/1	2.863€



Opciones para iCombi Pro e iCombi Classic



Protección para el panel de control

Protección lateral abatible de plástico antirotura (LEXAN) para el panel de control.

	XS 6-2/3	6-1/1	10-1/1	6-2/1	10-2/1	20-1/1	20-2/1
iCombi Pro	–	235€	235€	235€	235€	235€	235€
iCombi Classic	–	235€	235€	235€	235€	235€	235€

Sistemas de cocción tipo XS 6-2/3 con UltraVent premontada o UltraVent Plus

Las campanas de extracción premontada permiten una instalación especialmente rápida y sencilla de los sistemas de cocción del tipo XS 6-2/3 en el lugar de instalación.

	UltraVent, premontada sobre XS 6-2/3	UltraVent Plus, premontada sobre XS 6-2/3
iCombi Pro	3.551€	5.442€

Conexión a un sistema de optimización de energía

Interfaz para la conexión directa del sistema de cocción al sistema de optimización de energía de acuerdo con la norma DIN 18875. Solo disponible para equipos con tensiones de 3 NCA 400 V y 3 NCA 415 V.

	XS 6-2/3	6-1/1	10-1/1	6-2/1	10-2/1	20-1/1	20-2/1
iCombi Pro	74€	74€	74€	74€	74€	74€	74€
iCombi Classic	–	74€	74€	74€	74€	74€	74€

Toma para indicador de operaciones / contactos sin potencial

Puerto para la conexión directa del sistema de cocción al sistema de control operativo o para el control de los equipos externos como, p. ej., la ventilación.

	XS 6-2/3	6-1/1	10-1/1	6-2/1	10-2/1	20-1/1	20-2/1
iCombi Pro	74€	74€	74€	74€	74€	74€	74€
iCombi Classic	–	74€	74€	74€	74€	74€	74€

Puerto Ethernet

El puerto Ethernet (RJ45) permite la conexión a la red por cable del sistema de cocción. Permite establecer una conexión del sistema de cocción con ConnectedCooking.

	XS 6-2/3	6-1/1	10-1/1	6-2/1	10-2/1	20-1/1	20-2/1
iCombi Pro	•	•	•	•	•	•	•
iCombi Classic	–	65€	65€	65€	65€	65€	65€

Puerto Wi-Fi y Ethernet

Conexión a la red flexible y opcional del sistema de cocción mediante un puerto Wi-Fi sin cable (estándar IEEE 802.11) o por cable mediante la interfaz (RJ45). Permite establecer una conexión del sistema de cocción con ConnectedCooking.

	XS 6-2/3	6-1/1	10-1/1	6-2/1	10-2/1	20-1/1	20-2/1
iCombi Pro	•	•	•	•	•	•	•
iCombi Classic	–	79€	79€	79€	79€	79€	79€

Combi-Duo XS 6-2/3



Kit Combi-Duo para iCombi Pro XS 6-2/3 y CombiMaster Plus XS 6-2/3

Juego de montaje para combinación profesional de dos sistemas de cocción de RATIONAL (subestructura no incluida en el juego de montaje). Permite trabajar simultáneamente con diversos modos de cocción, sin necesidad de espacio adicional.

60.73.768	Tipo XS 6-2/3 sobre tipo XS 6-2/3 apertura hacia la derecha	670€
60.74.276	Tipo XS 6-2/3 sobre tipo XS 6-2/3 apertura inversa	670€
60.74.780	Tipo XS 6-2/3 sobre tipo XS 6-2/3 apertura hacia la derecha versión MarineLine	938€
60.74.929	Tipo XS 6-2/3 sobre tipo XS 6-2/3 apertura inversa versión MarineLine	938€



Mesa I para Combi-Duo

Abierta por todos los lados.

60.31.020	Estándar, dimensiones An P Al: 639 563 555 mm	573€
60.31.170	Con ruedas móviles, dimensiones An P Al: 663 641 562 mm	859€



Mesa II para Combi-Duo

4 pares de guías de soporte con un compartimento. Abierta por ambos lados, con paneles laterales.

60.31.046	Estándar, dimensiones An P Al: 639 563 557 mm	1.019€
60.31.058	Con elemento de fijación (MarineLine), dimensiones An P Al: 689 613 557 mm	1.273€



UltraVent y UltraVent Plus

UltraVent: campana de condensación para fijación y desvío de vapor. No es necesaria una toma externa.

UltraVent Plus: campana de condensación para fijación y desvío de vapor. La tecnología de filtros especial reduce el molesto humo. No es necesaria una toma externa.

60.73.943	UltraVent XS, conexión eléctrica 1 NAC 230V, dimensiones An P Al: 657 580 240 mm	3.610€
60.74.404	UltraVent Plus XS, conexión eléctrica 1 NAC 230V, dimensiones An P Al: 657 580 329 mm	5.501€

Kit de adaptador

Para el ajuste de una UltraVent XS existente o una UltraVent Plus XS en un montaje Combi-Duo.

60.73.945	Kit de adaptador UltraVent XS y UltraVent Plus XS para Combi-Duo	165€
-----------	--	------

Combi-Duo 6-1/1 y 10-1/1



Kit Combi-Duo

Juego de montaje para combinación profesional de dos sistemas de cocción de RATIONAL (subestructura no incluida en el juego de montaje). Permite trabajar simultáneamente con diversos modos de cocción, sin necesidad de espacio adicional.

	Sistema de cocción inferior	Sistema de cocción versión eléctrica superior		Sistema de cocción versión de gas superior
		XS 6-2/3	6-1/1	6-1/1
Estándar	Versión eléctrica	6-1/1	I	E
		10-1/1	I	E
	Versión para gas	6-1/1	G	G
		10-1/1	G	-
MarineLine	Versión eléctrica	6-1/1	-	K
		10-1/1	-	K

E	60.73.991	Combi-Duo tipo 6-1/1 E/G sobre tipo 6-1/1 o tipo 10-1/1 E	870€
G	60.75.751	Combi-Duo tipo 6-1/1 E/G o tipo XS 6-2/3 sobre tipo 6-1/1 G	1.219€
I	60.75.755	Combi-Duo tipo XS 6-2/3 sobre tipo 6-1/1 E	1.219€
K	60.76.708	Combi-Duo tipo 6-1/1 E sobre tipo 6-1/1 E o tipo 10-1/1 E MarineLine	1.219€



Kit de nivelación

Para la compensación de las diferencias de altura en el montaje de suelo o el montaje de sobremesa. La altura puede modificarse hasta 20 mm.

60.74.795	Kit de nivelación tipos 6-1/1, 10-1/1, dimensiones An P Al: 850 614 34 mm	286€
60.76.846	Kit de montaje de nivelación para modelos que requieran fijación (MarineLine) tipos 6-1/1, 10-1/1, dimensiones An P Al: 881 614 34 mm	415€



Subestructura con patas

La subestructura con patas permite una instalación elevada segura de los sistemas de cocción iCombi 6-1/1 y 10-1/1. La altura puede modificarse hasta 20 mm.

60.31.668	Tipos 6-1/1, 10-1/1, dimensiones An P Al: 870 635 152 mm	458€
-----------	--	------



Juego de montaje para Combi-Duo móvil

Juego de montaje con rodillos de altura regulable. La altura puede ajustarse libremente hasta 20 mm.

60.31.622	Tipos 6-1/1, 10-1/1, dimensiones An P Al: 848 773 85 mm	530€
-----------	---	------



Mesa I para Combi-Duo 6-1/1 sobre 6-1/1 o sobre 10-1/1 E

Abierta por todos los lados.

60.31.200	Estándar, dimensiones An P Al: 860 685 200 mm	573€
60.31.201	Con ruedas móviles de altura regulable, dimensiones An P Al: 884 763 200 mm	859€
60.31.202	Con elemento de fijación (MarineLine), dimensiones An P Al: 885 710 200 mm	716€



Mesa II para Combi-Duo 6-1/1 sobre 6-1/1

3 pares de guías. Abierta por ambos lados, con paneles laterales.

60.31.206	Estándar, dimensiones An P Al: 860 703 445 mm	1.400€
60.31.207	Con ruedas móviles de altura regulable, dimensiones An P Al: 884 769 445 mm	1.464€

Combi-Duo 6-1/1 y 10-1/1



Campana extractora, UltraVent y UltraVent Plus (solo para sistemas de cocción eléctricos)

Campana extractora: campana de salida para el desvío de los vapores. Requiere una conexión al exterior.

UltraVent: campana de condensación para fijación y desvío de vapor. No es necesaria una toma externa.

UltraVent Plus: campana de condensación para fijación y desvío de vapor. La tecnología de filtros especial reduce el molesto humo. No es necesaria una toma externa.

60.76.169	UltraVent Combi-Duo 6-1/1, 10-1/1, conexión eléctrica 1 NAC 230V, dimensiones An P Al: 854 970 313 mm	5.135€
60.76.173	UltraVent Plus Combi-Duo 6-1/1, 10-1/1, conexión eléctrica 1 NAC 230V, dimensiones An P Al: 854 970 403 mm	8.126€
60.76.221	Campana extractora Combi-Duo 6-1/1, 10-1/1, conexión eléctrica 1 NAC 230V, dimensiones An P Al: 854 970 359 mm	4.019€



Bastidor colgante tipo 6-1/1

60.61.678	Versión Combi-Duo, 5+1 guías (la guía superior es extraíble para una altura de carga máxima de 1,60 m, con montaje sobre el suelo 6-1/1 E sobre 10-1/1, E)	335€
-----------	--	------

Tapa de la ducha de mano

Para el cierre seguro del orificio de la ducha de mano en el zócalo. El kit incluye la tapa y un tapón para el cierre higiénico y seguro del paso del agua durante el desmontaje de la ducha de mano, por ejemplo, en el sistema de cocción inferior de Combi-Duo.

87.01.790S	Tapa de la ducha de mano	47€
------------	--------------------------	-----



Carro de transporte Combi-Duo para rack móvil

El carro de transporte puede ajustarse de forma óptima a la altura de la instalación correspondiente.

60.75.388	Para Combi-Duo, dimensiones An P Al: 561 842 1052-1478 mm	1.799€
-----------	---	--------



Guía de inserción para rack móvil Combi-Duo

Las guías de inserción son necesarias para el uso de un rack móvil en Combi-Duo.

60.75.761	Guía de inserción Combi-Duo para rack móvil para platos	188€
-----------	---	------



Kit con drenaje de grasa integrado para Combi-Duo

Ampliación de la opción de drenaje de grasa integrado (página [8]): sistema de tuberías, fijaciones y recipientes.

60.75.873	Kit de drenaje de grasa integrado para montaje en kit de nivelación	930€
60.75.406	Kit de drenaje de grasa integrado para montaje en kit de nivelación en Mesa I Combi-Duo	744€
60.75.874	Kit de drenaje de grasa integrado para montaje en kit de nivelación en Mesa II Combi-Duo	855€



Carro de transporte para contenedores

Permite transportar los bidones/recipientes llenos de forma segura.

60.73.309	Carro de transporte para contenedores con drenaje de grasa integrado (Combi-Duo y equipos de suelo)	521€
-----------	---	------

Combi-Duo 6-2/1 y 10-2/1



Kit Combi-Duo

Juego de montaje para combinación profesional de dos sistemas de cocción de RATIONAL (subestructura no incluida en el juego de montaje). Permite trabajar simultáneamente con diversos modos de cocción, sin necesidad de espacio adicional.

	Sistema de cocción inferior	Sistema de cocción versión eléctrica superior			Sistema de cocción versión gas superior		
		XS 6-2/3	6-1/1	6-2/1	6-1/1	6-2/1	
Estándar	Versión eléctrica	6-2/1	J	J	F	J	F
		10-2/1	J	-	F	-	F
	Versión para gas	6-2/1	H	H	H	H	H
		10-2/1	H	-	-	-	-
MarineLine	Versión eléctrica	6-2/1 apertura hacia la derecha	-	-	L	-	-
		10-2/1 apertura hacia la derecha	-	-	L	-	-
		6-2/1 apertura a la izquierda	-	-	M	-	-
		10-2/1 apertura a la izquierda	-	-	M	-	-
F	60.74.725	Combi-Duo tipo 6-2/1 E/G sobre tipo 6-2/1 o tipo 10-2/1 E					1.132€
H	60.75.752	Combi-Duo tipo 6-1/1, tipo 6-2/1 E/G o tipo XS 6-2/3 sobre tipo 6-2/1 G					1.584€
J	60.75.756	Combi-Duo tipo 6-1/1 E/G o tipo XS 6-2/3 sobre tipo 6-2/1 E					1.584€
L	60.76.709	Combi-Duo tipo 6-2/1 sobre tipo 6-2/1 E o tipo 10-2/1 E con apertura hacia la derecha MarineLine					1.584€
M	60.76.710	Combi-Duo tipo 6-2/1 sobre tipo 6-2/1 E o tipo 10-2/1 E con apertura hacia la izquierda MarineLine					1.584€



Kit de nivelación

Para la compensación de las diferencias de altura en el montaje de suelo o el montaje de sobremesa. La altura puede modificarse hasta 20 mm.

60.74.597	Kit de nivelación tipos 6-2/1, 10-2/1, dimensiones An P Al: 1072 814 34 mm	326€
60.76.845	Kit de montaje de nivelación para modelos que requieran fijación (MarineLine) tipos 6-2/1, 10-2/1, dimensiones An P Al: 1103 814 34 mm	473€



Subestructura con patas

La subestructura con patas permite una instalación elevada segura de los sistemas de cocción iCombi 6-2/1 y 10-2/1. La altura puede modificarse hasta 20 mm.

60.31.671	Tipos 6-2/1, 10-2/1, dimensiones An P Al: 1092 835 152 mm	522€
-----------	---	------



Juego de montaje para Combi-Duo móvil

Juego de montaje con rodillos de altura regulable. La altura puede ajustarse libremente hasta 20 mm.

60.31.635	Tipos 6-2/1, 10-2/1, dimensiones An P Al: 1106 856 85 mm	604€
-----------	--	------



Mesa I para Combi-Duo 6-2/1 sobre 6-2/1 o sobre 10-2/1 E

Abierta por todos los lados.

60.31.203	Estándar, dimensiones An P Al: 1082 885 200 mm	653€
60.31.204	Con ruedas móviles de altura regulable, dimensiones An P Al: 1106 963 200 mm	979€
60.31.205	Con elemento de fijación (MarineLine), dimensiones An P Al: 1107 910 200 mm	816€

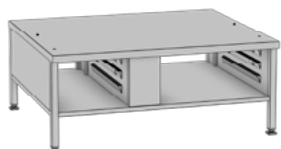

Mesa II para Combi-Duo 6-2/1 sobre 6-2/1

3 pares de guías. Abierta por ambos lados, con paneles laterales.

60.31.208	Estándar, dimensiones An P Al: 1082 903 445 mm	1.597€
-----------	--	--------

Combi-Duo 6-2/1 y 10-2/1



Campana extractora, UltraVent y UltraVent Plus (solo para sistemas de cocción eléctricos)

Campana extractora: campana de salida para el desvío de los vapores. Requiere una conexión al exterior.

UltraVent: campana de condensación para fijación y desvío de vapor. No es necesaria una toma externa.

UltraVent Plus: campana de condensación para fijación y desvío de vapor. La tecnología de filtros especial reduce el molesto humo. No es necesaria una toma externa.

60.76.170	UltraVent Combi-Duo 6-2/1, 10-2/1, conexión eléctrica 1 NAC 230V, dimensiones An P Al: 1075 1170 313 mm	6.367€
60.76.174	UltraVent Plus Combi-Duo 6-2/1, 10-2/1, conexión eléctrica 1 NAC 230V, dimensiones An P Al: 1075 1170 407 mm	10.077€
60.76.222	Campana extractora Combi-Duo 6-2/1, 10-2/1, conexión eléctrica 1 NAC 230V, dimensiones An P Al: 1075 1170 359 mm	4.983€



Bastidor colgante tipo 6-2/1

60.62.188	Versión Combi-Duo, 5+1 guías (la guía superior es extraíble para una altura de carga máxima de 1,60 m, con montaje sobre el suelo 6-2/1 E sobre 10-2/1 E)	335€
-----------	---	------

Tapa de la ducha de mano

Para el cierre seguro del orificio de la ducha de mano en el zócalo. El kit incluye la tapa y un tapón para el cierre higiénico y seguro del paso del agua durante el desmontaje de la ducha de mano, por ejemplo, en el sistema de cocción inferior de Combi-Duo.

87.01.790S	Tapa de la ducha de mano	47€
------------	--------------------------	-----

Carro de transporte Combi-Duo para rack móvil

El carro de transporte puede ajustarse de forma óptima a la altura de la instalación correspondiente.

60.75.387	Para Combi-Duo, dimensiones An P Al: 773 961 1052-1418 mm	2.339€
-----------	---	--------



Guía de inserción para rack móvil Combi-Duo

Las guías de inserción son necesarias para el uso de un rack móvil en Combi-Duo.

60.75.760	Guía de inserción Combi-Duo para rack móvil para platos	210€
-----------	---	------

Kit con drenaje de grasa integrado para Combi-Duo

Ampliación de la opción de drenaje de grasa integrado (página [8]): sistema de tuberías, fijaciones y recipientes.

60.75.876	Kit de drenaje de grasa integrado para montaje en kit de nivelación	1.116€
60.75.411	Kit de drenaje de grasa integrado para montaje en kit de nivelación en Mesa I Combi-Duo	893€
60.75.875	Kit de drenaje de grasa integrado para montaje en kit de nivelación en Mesa II Combi-Duo	1.026€



Carro de transporte para contenedores

Permite transportar los bidones/recipientes llenos de forma segura.

60.73.309	Carro de transporte para contenedores con drenaje de grasa integrado (Combi-Duo y equipos de suelo)	521€
-----------	---	------



Productos de limpieza del iCombi



Pastillas de detergente Active Green para iCombi Pro y iCombi Classic

La nueva fórmula sin fosfatos altamente efectiva ahorra hasta un 50 % en productos de limpieza de uso habitual.

56.01.535	Pastillas de detergente Active Green, 150 unidades	126€
-----------	--	------



Pastillas de detergente para SelfCookingCenter y CombiMaster Plus (a partir de 05/2017)

Pastillas de detergente con principios activos intensivos para una limpieza fiable de alto rendimiento.

56.00.210	Pastillas de detergente, 100 unidades	96€
-----------	---------------------------------------	-----



Pastillas Care para iCombi Pro, iCombi Classic y SelfCookingCenter con Efficient CareControl

Las sustancias de mantenimiento protegen de forma activa frente a los depósitos de cal en la cámara de cocción y el generador de vapor. Siempre está asegurada la seguridad de funcionamiento, sin desendurecimiento del agua ni descalcificación manual.

56.00.562	Pastillas Care, 150 unidades	113€
-----------	------------------------------	------



Pastilla de abrillantador para SelfCookingCenter sin Efficient CareControl y CombiMaster Plus (a partir de 05/2017)

Protege activamente y prolonga la vida útil gracias a sustancias limpiadoras altamente eficaces. La cámara de cocción queda totalmente limpia, higiénica y brillante.

56.00.211	Pastillas de abrillantador, 50 unidades	60€
-----------	---	-----



Detergente líquido para todos los CombiMaster y ClimaPlus Combi

9006.0153	Detergente para parrilla para suciedad incrustada, 10 l	70€
9006.0137	Abrillantador, 10 l (solo para ClimaPlus Combi con CleanJet)	70€



Descalcificador, bomba descalcificadora

Para una descalcificación eficaz del generador de vapor con sustancias de mantenimiento especiales.

6006.0110	Descalcificador, 10 l	70€
6004.0203	Bomba de pedal para la descalcificación del generador de vapor	132€



Pistola pulverizadora manual

Manejo ultrasencillo gracias al mecanismo integrado de la bomba.

6004.0100	Pistola pulverizadora para la limpieza manual	41€
-----------	---	-----

Accesorios tipo XS 6-2/3



Mesa XS

Para un montaje elevado de 150 hasta 190 mm sobre superficies de trabajo bajas y para compensar superficies de trabajo con ligeros desniveles, también para la fijación a una mesa (MarineLine). Abierta por todos los lados. Dimensiones An | P | Al: 629 | 438 | 148 mm

60.31.029	Estándar	320€
-----------	----------	------

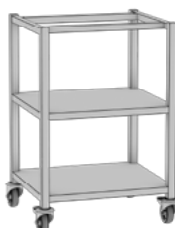

Mesa I

Abierta por todos los lados.

60.31.018	Estándar, dimensiones An P Al: 639 563 931 mm	630€
60.31.169	Con ruedas móviles, dimensiones An P Al: 663 641 938 mm	859€



Mesa II

8 pares de guías de soporte con dos compartimentos y nivel intermedio. Abierta por ambos lados, con paneles laterales.

60.31.044	Estándar, dimensiones An P Al: 639 563 932 mm	1.400€
60.31.057	Con elemento de fijación (MarineLine), dimensiones An P Al: 689 613 932 mm	1.591€



Soporte mural para fijación a la pared

Para sitios con poco espacio está disponible la opción que permite fijar el equipo a la pared (material de montaje no incluido). Los requerimientos para instalación deben consultarse con un arquitecto o aparejador.

60.30.968	Soporte mural para fijación a la pared XS 6-2/3	370€
-----------	---	------



UltraVent

Campana de condensación para fijación y desvío de vapor. No es necesaria una toma externa. Conexión eléctrica 1 NAC 230 V, dimensiones An | P | Al: 657 | 580 | 240 mm

60.73.865	Tipo XS 6-2/3	3.438€
-----------	---------------	--------



UltraVent Plus

Campana de condensación para fijación y desvío de vapor. La tecnología de filtros especial reduce el molesto humo. No es necesaria una toma externa. Conexión eléctrica 1 NAC 230 V, dimensiones An | P | Al: 657 | 580 | 329 mm

60.74.394	Tipo XS 6-2/3	5.329€
-----------	---------------	--------

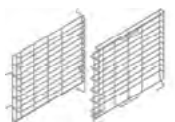

Bastidor colgante

60.73.724	Estándar	258€
60.74.449	Versión marina (con elementos de protección de carga)	335€



Kit de montaje

Para la integración profesional de equipos tipo XS 6-2/3 incl. UltraVent XS o UltraVent Plus XS en una pared estantería.

60.74.063	UltraVent XS con kit de montaje incluido	4.229€
60.74.405	UltraVent Plus XS con kit de montaje incluido	6.085€

Accesorios tipo XS 6-2/3



Blindaje térmico para panel lateral

La instalación a posteriori del blindaje térmico permite la colocación de fuentes de calor (por ejemplo, una parrilla) cerca del panel lateral del equipo.

60.74.182	Blindaje izquierdo, tipo XS 6-2/3	206€
-----------	-----------------------------------	------



Interruptor de condensación

Genera una elevación acelerada del vapor y de otros vahos sacándolos por el tubo de ventilación.

60.74.037	Tipo XS 6-2/3 (Al: 438 mm)	170€
-----------	----------------------------	------



Kit de conexión de equipos

Compuesto de manguera de alimentación de agua (2 m) y tuberías de desagüe DN 50.

60.70.464	Tipos XS 6-2/3, 6-1/1, 10-1/1, 6-2/1, 10-2/1, 20-1/1, 20-2/1	84€
-----------	--	-----



USB de RATIONAL

42.00.162	Memoria USB 3.0 para programas de cocción y datos APPCC	16€
-----------	---	-----

Accesorios tipo 6-1/1 y 10-1/1



Kit de nivelación

Para la compensación de las diferencias de altura en el montaje de suelo o el montaje de sobremesa. La altura puede modificarse hasta 20 mm.

60.74.795	Kit de nivelación tipos 6-1/1, 10-1/1, dimensiones An P Al: 850 614 34 mm	286 €
60.76.846	Kit de montaje de nivelación para modelos que requieran fijación (MarineLine) tipos 6-1/1, 10-1/1, dimensiones An P Al: 881 614 34 mm	415 €

Extensión de mesa

Para la instalación sobre una 700 mm encimera de trabajo baja.

60.11.655	Tipos 6-1/1, 10-1/1, dimensiones An P Al: 840 100 2 mm	43 €
-----------	--	------



Subestructura con patas

La subestructura con patas permite una instalación elevada segura de los sistemas de cocción iCombi 6-1/1 y 10-1/1. La altura puede modificarse hasta 20 mm. Para montaje en mesa sobre superficies de trabajo con una profundidad mín. de 700 mm.

60.31.668	Tipos 6-1/1, 10-1/1, dimensiones An P Al: 870 635 152 mm	458 €
-----------	--	-------



Mesa I

Abierta por todos los lados.

60.31.089	Estándar, dimensiones An P Al: 860 685 699 mm	573 €
60.31.095	Con ruedas móviles de altura regulable, dimensiones An P Al: 884 763 699 mm	859 €
60.31.096	Con elemento de fijación (MarineLine), dimensiones An P Al: 885 710 699 mm	716 €



Mesa II

14 pares de guías. Abierta por ambos lados, con paneles laterales.

60.31.086	Estándar, dimensiones An P Al: 860 703 699 mm	1.273 €
60.31.103	Con ruedas móviles de altura regulable, dimensiones An P Al: 884 769 699 mm	1.591 €
60.31.110	Con elemento de fijación (MarineLine), dimensiones An P Al: 885 716 699 mm	1.591 €



Mesa II medidas de panadería

14 pares de guías 400 x 600 mm. Abierta por ambos lados, con paneles laterales.

60.31.209	Estándar, dimensiones An P Al: 860 703 699 mm	1.400 €
60.31.210	Con ruedas móviles de altura regulable, dimensiones An P Al: 884 769 699 mm	1.719 €
60.31.211	Con elemento de fijación (MarineLine), dimensiones An P Al: 885 716 699 mm	1.591 €



Mesa II medidas de panadería, versión UltraVent, tipo 6-1/1

20 pares de guías 400 x 600 mm. Abierta por ambos lados, con paneles laterales. Se eleva para la instalación de una campana de compensación.

60.31.212	Estándar, dimensiones An P Al: 860 703 945 mm	1.782 €
60.31.213	Con ruedas móviles de altura regulable, dimensiones An P Al: 884 769 945 mm	2.037 €



Mesa II MobilityLine

114 pares de guías. Abierta por ambos lados, con paneles laterales, refuerzo lateral. Cuatro ruedas de acero inoxidable con Ø 200 mm. Edición con protección lateral.

60.31.164	MobilityLine, dimensiones An P Al: 1199 894 789 mm	2.737 €
-----------	--	---------

Accesorios tipo 6-1/1 y 10-1/1



Mesa III

14 pares de guías. Abierta por un lado, con paneles laterales, panel trasero y tapa.

60.31.091	Estándar, dimensiones An P Al: 860 703 699 mm	1.502 €
60.31.105	Con ruedas móviles de altura regulable, dimensiones An P Al: 884 769 699 mm	1.953 €
60.31.112	Con elemento de fijación (MarineLine), dimensiones An P Al: 885 716 699 mm	1.728 €



Mesa III versión UltraVent, tipo 6-1/1

20 pares de guías. Abierta por un lado, con paneles laterales, panel trasero y tapa. Se eleva para la instalación de una campana de compensación.

60.31.214	Estándar, dimensiones An P Al: 860 703 945 mm	1.803 €
60.31.215	Con ruedas móviles de altura regulable, dimensiones An P Al: 884 769 945 mm	2.179 €



Mesa IV

14 pares de guías. Cerrada por todos los lados, con puertas batientes.

60.31.093	Estándar, dimensiones An P Al: 860 703 699 mm	2.144 €
60.31.107	Con ruedas móviles de altura regulable, dimensiones An P Al: 884 769 699 mm	2.572 €
60.31.114	Con elemento de fijación (MarineLine), dimensiones An P Al: 885 716 699 mm	2.358 €



UltraVent (solo para sistemas de cocción eléctricos)

Campana de condensación para fijación y desvío de vapor. No es necesaria una toma externa. Conexión eléctrica 1 NAC 230 V, dimensiones An | P | Al: 854 | 885 | 313 mm

60.75.134	Tipos 6-1/1, 10-1/1	4.465 €
-----------	---------------------	---------



UltraVent Plus (solo para sistemas de cocción eléctricos)

Campana de condensación para fijación y desvío de vapor. La tecnología de filtros especial reduce el molesto humo. No es necesaria una toma externa. Conexión eléctrica 1 NAC 230 V, dimensiones An | P | Al: 854 | 885 | 403 mm

60.75.142	Tipos 6-1/1, 10-1/1	6.921 €
-----------	---------------------	---------



Campana extractora (solo para sistemas de cocción eléctricos)

Campana de salida para el desvío de los vapores. Requiere una conexión al exterior. Conexión eléctrica 1 NAC 230 V, dimensiones An | P | Al: 854 | 885 | 359 mm

60.76.217	Tipos 6-1/1, 10-1/1	3.483 €
-----------	---------------------	---------



Bastidor colgante tipo 6-1/1

60.61.373	Estándar, 6 guías (distancia entre guías 68 mm)	335 €
60.61.615	5 guías (distancia entre guías 85 mm)	335 €
60.61.649	Bandejas para carne, 6 guías (distancia entre guías 72 mm)	502 €
60.61.576	Medidas de panadería (400 × 600 mm), 5 guías (distancia entre guías 88 mm)*	335 €
60.61.642	Combi-Rack, medidas de panadería combinado con 1/1 GN, 4 guías (distancia entre guías 95 mm)*	502 €
60.61.672	Versión marina (USPHS), 6 guías (con elemento de protección de carga)	435 €

* Debe tenerse en cuenta que el deflector en la cámara de cocción del tipo GN y en el tipo de panadería 400 × 600 mm son diferentes. El deflector puede adquirirse como pieza de repuesto a través del servicio técnico.

Accesorios tipo 6-1/1 y 10-1/1

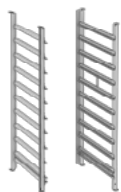

Bastidor colgante tipo 10-1/1

60.11.447	Estándar, 10 guías (distancia entre guías 68 mm)	408 €
60.11.547	8 guías (distancia entre guías 85 mm)	408 €
60.11.570	Bandejas para carne, 10 guías (distancia entre guías 72 mm)	613 €
60.11.541	Medidas de panadería (400 × 600 mm), 8 guías (distancia entre guías 90 mm)*	408 €
60.11.563	Combi-Rack, medidas de panadería combinado con 1/1 GN, 7 guías (distancia entre guías 95 mm)*	613 €
60.11.573	Versión marina (USPHS), 10 guías (con elemento de protección de carga)	531 €



Carriles de extracción para sistemas de cocción 6-1/1, 10-1/1

Carriles de extracción para facilitar el uso de accesorios de cocción en bastidores colgantes con una distancia entre carriles de 68 mm.

60.76.894	Carriles de extracción para iCombi Pro e iCombi Classic, 1/1 GN (325 × 530 mm)	308 €
60.76.897	Carriles de extracción para SelfCookingCenter y CombiMaster Plus (desde 09/2011), 1/1 GN (325 × 530 mm)	308 €



Rack móvil tipo 6-1/1

Solo en combinación con las guías de inserción para rack móvil.

60.61.420	Estándar, 6 guías (distancia entre guías 64 mm)	642 €
60.61.690	Medidas de panadería (400 × 600 mm), 5 guías (distancia entre guías 77 mm)*	706 €

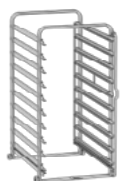

Rack móvil tipo 10-1/1

Solo en combinación con las guías de inserción para rack móvil.

60.11.600	Estándar, 10 guías (distancia entre guías 64 mm)	835 €
60.11.601	8 guías (distancia entre guías 80 mm)	835 €
60.11.599	Medidas de panadería (400 × 600 mm), 8 guías (distancia entre guías 81 mm)*	918 €

* Debe tenerse en cuenta que el deflector en la cámara de cocción del tipo GN y en el tipo de panadería 400 × 600 mm son diferentes. El deflector puede adquirirse como pieza de repuesto a través del servicio técnico.



Guía de inserción para rack móvil

Las guías de inserción son necesarias para el uso de un rack intercambiable para platos.

60.75.115	Guía de inserción estándar tipo 6-1/1, 10-1/1	188 €
-----------	---	-------



Carro de transporte para rack móvil

El carro de transporte facilita la carga y descarga del rack móvil también fuera del sistema de cocción y un transporte seguro.

La versión estándar está óptimamente adaptada a la altura de la mesa.

El carro de transporte de altura regulable sirve para el montaje del sistema de cocción en las mesas de trabajo y las mesas altas.

60.74.000	Estándar, dimensiones An P Al: 525 911 990 mm	905 €
60.75.606	Altura regulable, dimensiones An P Al: 525 911 800-1330 mm	1.447 €

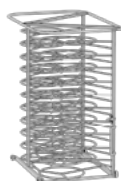

Rack móvil para platos

El rack móvil para platos admite platos preparados (de hasta 31 cm de diámetro) para su regeneración en Finishing. Solo en combinación con las guías de inserción para rack móvil.

60.61.702	Tipo 6-1/1, 20 platos	867 €
60.61.701	Tipo 6-1/1, 15 platos	789 €
60.11.581	Tipo 10-1/1, 32 platos	1.041 €
60.11.602	Tipo 10-1/1, 26 platos	946 €

Accesorios tipo 6-1/1 y 10-1/1



Sistemas de Finishing para banquetes

El sistema Finishing contiene todos los accesorios necesarios para poder empezar inmediatamente. Compuesto por rack móvil, Thermocover y carro de transporte. Solo en combinación con las guías de inserción para rack móvil.

Ahorre hasta el 15 % en comparación con el precio de compra.

60.61.741	Tipo 6-1/1, 20 platos	1.977 €
60.11.628	Tipo 10-1/1, 32 platos	2.266 €
60.11.629	Tipo 10-1/1, 26 platos	2.185 €

Thermocover

Gracias al material termoaislante especial los platos se mantienen calientes hasta 20 minutos después del Finishing. Cierre magnético sencillo para abrir y cerrar fácilmente.

6004.1007	Tipo 6-1/1	554 €
6004.1009	Tipo 10-1/1	720 €

Sonda térmica USB

Es posible conectar sondas térmicas externas adicionales fácilmente mediante una conexión USB. La sonda térmica externa permite el control de un plato en iCombi Pro o puede utilizarse como sustituta a la sonda térmica interna en iCombi Classic. La sonda térmica para cocción al vacío permite la cocción con bolsa al vacío con el control exacto de la temperatura del núcleo.

El set de ampliación permite instalar una sonda térmica del núcleo en otro sistema de cocción con arreglo a la normativa de higiene.

60.76.316	Sonda térmica para cocción al vacío para equipos de mesa y equipos de suelo	657 €
60.76.317	1 sonda térmica externa para equipos de mesa	548 €
60.76.876	Set de ampliación para sonda térmica del núcleo en USB	164 €

Elemento auxiliar de posicionamiento para la sonda térmica

Facilita la colocación correcta de la sonda térmica en productos líquidos, blandos o muy pequeños. El elemento auxiliar de colocación puede fijarse en los racks móviles y los bastidores colgantes.

60.71.022	Tipos 6-1/1, 10-1/1, 6-2/1, 10-2/1, 20-1/1 y 20-2/1	15 €
-----------	---	------

Soporte mural para fijación a la pared

Para sitios con poco espacio está disponible la opción que permite fijar el equipo a la pared (material de montaje no incluido). Los requerimientos para instalación deben consultarse con un arquitecto o aparejador.

60.31.168	Soporte mural para fijación a la pared tipo 6-1/1	536 €
-----------	---	-------

Blindaje térmico para panel lateral

La instalación a posteriori del blindaje térmico permite la colocación de fuentes de calor (por ejemplo, una parrilla) cerca del panel lateral del equipo.

60.75.110	Blindaje izquierdo, tipo 6-1/1	243 €
60.75.113	Blindaje derecho, tipo 6-1/1	243 €
60.75.773	Blindaje izquierdo, tipo 10-1/1	279 €
60.75.771	Blindaje derecho, tipo 10-1/1	279 €

Interruptor de condensación

Genera una elevación acelerada del vapor y de otros vahos sacándolos por el tubo de ventilación.

60.72.592	Tipos 6-1/1, 10-1/1, 6-2/1 y 10-2/1 (Al: 458 mm)	170 €
-----------	--	-------

Kit de conexión de equipos

Compuesto de manguera de alimentación de agua (2 m) y tuberías de desagüe DN 50.

60.70.464	Tipos XS 6-2/3, 6-1/1, 10-1/1, 6-2/1, 10-2/1, 20-1/1, 20-2/1	84 €
-----------	--	------

Accesorios tipo 6-1/1 y 10-1/1



Colector de escape

Para la evacuación de emisiones a través de un único tubo en el techo de ventilación (diámetro del tubo de escape 180 mm).

70.01.360	Tipo 6-1/1	240€
70.01.376	Tipo 10-1/1	240€



Seguro de flujo para salida de aire

Para la evacuación de emisiones a través de un único tubo en la chimenea (diámetro del tubo de escape 180 mm).

70.01.339	Tipo 6-1/1	283€
70.01.340	Tipo 10-1/1	283€



USB de RATIONAL

42.00.162	Memoria USB 3.0 para programas de cocción y datos APPCC	16€
-----------	---	-----

Accesorios tipo 6-2/1 y 10-2/1



Kit de nivelación

Para la compensación de las diferencias de altura en el montaje de suelo o el montaje de sobremesa. La altura puede modificarse hasta 20 mm.

60.74.597	Kit de nivelación tipos 6-2/1, 10-2/1, dimensiones An P Al: 1072 814 34 mm	326 €
60.76.845	Kit de montaje de nivelación para modelos que requieran fijación (MarineLine) tipos 6-2/1, 10-2/1, dimensiones An P Al: 1103 814 34 mm	473 €



Subestructura con patas

La subestructura con patas permite una instalación elevada segura de los sistemas de cocción iCombi 6-2/1 y 10-2/1. La altura puede modificarse hasta 20 mm.

60.31.671	Tipos 6-2/1, 10-2/1, dimensiones An P Al: 1092 835 152 mm	522 €
-----------	---	-------



Mesa I

Abierta por todos los lados.

60.31.090	Estándar, dimensiones An P Al: 1082 885 699 mm	653 €
60.31.102	Con ruedas móviles de altura regulable, dimensiones An P Al: 1106 963 699 mm	979 €
60.31.109	Con elemento de fijación (MarineLine), dimensiones An P Al: 1107 910 699 mm	816 €

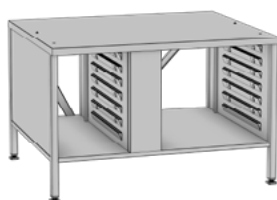

Mesa II

14 pares de guías. Abierta por ambos lados, con paneles laterales.

60.31.087	Estándar, dimensiones An P Al: 1082 903 699 mm	1.451 €
60.31.104	Con ruedas móviles de altura regulable, dimensiones An P Al: 1106 969 699 mm	1.814 €
60.31.111	Con elemento de fijación (MarineLine), dimensiones An P Al: 1107 916 699 mm	1.814 €



Mesa II MobilityLine

14 pares de guías. Abierta por ambos lados, con paneles laterales, refuerzo lateral. Cuatro ruedas de acero inoxidable con Ø 200 mm. Edición con protección lateral.

60.31.165	MobilityLine, dimensiones An P Al: 1421 1094 789 mm	3.120 €
-----------	---	---------

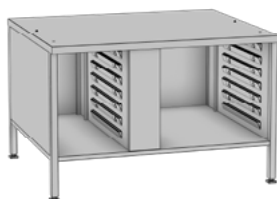

Mesa III

14 pares de guías. Abierta por un lado, con paneles laterales, panel trasero y tapa.

60.31.092	Estándar, dimensiones An P Al: 1082 903 699 mm	1.713 €
60.31.106	Con ruedas móviles de altura regulable, dimensiones An P Al: 1106 969 699 mm	2.227 €
60.31.113	Con elemento de fijación (MarineLine), dimensiones An P Al: 1107 916 699 mm	1.970 €



Mesa III versión UltraVent, tipo 6-2/1

20 pares de guías. Abierta por un lado, con paneles laterales, panel trasero y tapa. Se eleva para la instalación de una campana de compensación.

60.31.216	Estándar, dimensiones An P Al: 1082 903 945 mm	2.055 €
60.31.217	Con ruedas móviles de altura regulable, dimensiones An P Al: 1106 969 945 mm	2.484 €

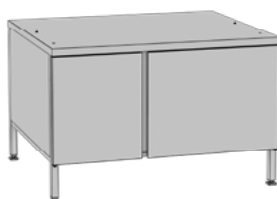

Mesa IV

14 pares de guías. Cerrada por todos los lados, con puertas batientes.

60.31.094	Estándar, dimensiones An P Al: 1082 903 699 mm	2.444 €
60.31.108	Con ruedas móviles de altura regulable, dimensiones An P Al: 1106 969 699 mm	2.932 €
60.31.115	Con elemento de fijación (MarineLine), dimensiones An P Al: 1107 916 699 mm	2.688 €

Accesorios tipo 6-2/1 y 10-2/1



UltraVent (solo para sistemas de cocción eléctricos)

Campana de condensación para fijación y desvío de vapor. No es necesaria una toma externa. Conexión eléctrica 1 NAC 230 V, dimensiones An | P | Al: 1075 | 1085 | 313 mm

60.75.135	Tipos 6-2/1, 10-2/1	5.537€
-----------	---------------------	--------



UltraVent Plus (solo para sistemas de cocción eléctricos)

Campana de condensación para fijación y desvío de vapor. La tecnología de filtros especial reduce el molesto humo. No es necesaria una toma externa.

Conexión eléctrica 1 NAC 230 V, dimensiones An | P | Al: 1075 | 1085 | 407 mm

60.75.143	Tipos 6-2/1, 10-2/1	8.582€
-----------	---------------------	--------



Campana extractora (solo para sistemas de cocción eléctricos)

Campana de salida para el desvío de los vapores. Requiere una conexión al exterior.

Conexión eléctrica 1 NAC 230 V, dimensiones An | P | Al: 1075 | 1085 | 359 mm

60.76.218	Tipos 6-2/1, 10-2/1	4.319€
-----------	---------------------	--------



Bastidor colgante tipo 6-2/1

60.62.123	Estándar, 6 guías (distancia entre guías 68 mm)	435€
60.62.171	5 guías (distancia entre guías 85 mm)	435€
60.62.168	7 guías (distancia entre guías 65 mm)	435€
60.62.178	Versión marina (USPHS), 6 guías (con elemento de protección de carga)	566€

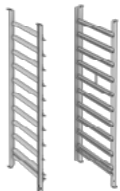

Bastidor colgante tipo 10-2/1

60.12.133	Estándar, 10 guías (distancia entre guías 68 mm)	499€
60.12.143	8 guías (distancia entre guías 85 mm)	499€
60.12.146	Versión marina (USPHS), 10 guías (con elemento de protección de carga)	648€



Rack móvil tipo 6-2/1

Solo en combinación con las guías de inserción para rack móvil.

60.62.150	Estándar, 6 guías (distancia entre guías 64 mm)	899€
-----------	---	------



Rack móvil tipo 10-2/1

Solo en combinación con las guías de inserción para rack móvil.

60.12.150	Estándar, 10 guías (distancia entre guías 63 mm)	1.092€
-----------	--	--------



Guía de inserción para rack móvil

Las guías de inserción son necesarias para el uso de un rack intercambiable para platos.

60.74.650	Guía de inserción estándar tipo 6-2/1, 10-2/1	210€
-----------	---	------



Carro de transporte para rack móvil

El carro de transporte facilita la carga y descarga del rack móvil también fuera del sistema de cocción y un transporte seguro.

La versión estándar está óptimamente adaptada a la altura de la mesa.

El carro de transporte de altura regulable sirve para el montaje del sistema de cocción en las mesas de trabajo y las mesas altas.

60.73.999	Estándar, dimensiones An P Al: 735 996 990 mm	1.176€
60.75.605	Altura regulable, dimensiones An P Al: 735 990 800-1330 mm	1.882€

Accesorios tipo 6-2/1 y 10-2/1

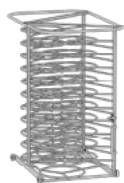

Rack móvil para platos

El rack móvil para platos admite platos preparados (de hasta 31 cm de diámetro) para su regeneración en Finishing. Solo en combinación con las guías de inserción para rack móvil.

60.62.017	Tipo 6-2/1, 34 platos	1.230€
60.12.022	Tipo 10-2/1, 52 platos	1.538€
60.12.062	Tipo 10-2/1, 42 platos	1.301€



Sistemas de Finishing para banquetes

El sistema Finishing contiene todos los accesorios necesarios para poder empezar inmediatamente. Compuesto por rack móvil, Thermocover y carro de transporte. Solo en combinación con las guías de inserción para rack móvil.

Ahorre hasta el 15 % en comparación con el precio de compra.

60.62.196	Tipo 6-2/1, 34 platos	2.705€
60.12.154	Tipo 10-2/1, 42 platos	2.906€
60.12.155	Tipo 10-2/1, 52 platos	3.107€



Thermocover

Gracias al material termoaislante especial los platos se mantienen calientes hasta 20 minutos después del Finishing. Cierre magnético sencillo para abrir y cerrar fácilmente.

6004.1016	Tipo 6-2/1	776€
6004.1014	Tipo 10-2/1	942€



Sonda térmica USB

Es posible conectar sondas térmicas externas adicionales fácilmente mediante una conexión USB. La sonda térmica externa permite el control de un plato en iCombi Pro o puede utilizarse como sustituta a la sonda térmica interna en iCombi Classic. La sonda térmica para cocción al vacío permite la cocción con bolsa al vacío con el control exacto de la temperatura del núcleo.

El set de ampliación permite instalar una sonda térmica del núcleo en otro sistema de cocción con arreglo a la normativa de higiene.

60.76.316	Sonda térmica para cocción al vacío para equipos de mesa y equipos de suelo	657€
60.76.317	1 sonda térmica externa para equipos de mesa	548€
60.76.876	Set de ampliación para sonda térmica del núcleo en USB	164€

Elemento auxiliar de posicionamiento para la sonda térmica

Facilita la colocación correcta de la sonda térmica en productos líquidos, blandos o muy pequeños. El elemento auxiliar de colocación puede fijarse en los racks móviles y los bastidores colgantes.

60.71.022	Tipos 6-1/1, 10-1/1, 6-2/1, 10-2/1, 20-1/1 y 20-2/1	15€
-----------	---	-----



Blindaje térmico para panel lateral

La instalación a posteriori del blindaje térmico permite la colocación de fuentes de calor (por ejemplo, una parrilla) cerca del panel lateral del equipo.

60.75.769	Blindaje izquierdo, tipo 6-2/1	291€
60.75.768	Blindaje derecho, tipo 6-2/1	291€
60.75.776	Blindaje izquierdo, tipo 10-2/1	340€
60.75.774	Blindaje derecho, tipo 10-2/1	340€



Interruptor de condensación

Genera una elevación acelerada del vapor y de otros vahos sacándolos por el tubo de ventilación.

60.72.592	Tipos 6-1/1, 10-1/1, 6-2/1 y 10-2/1 (Al: 458 mm)	170€
-----------	--	------

Accesorios tipo 6-2/1 y 10-2/1



Kit de conexión de equipos

Compuesto de manguera de alimentación de agua (2 m) y tuberías de desagüe DN 50.

60.70.464	Tipos XS 6-2/3, 6-1/1, 10-1/1, 6-2/1, 10-2/1, 20-1/1, 20-2/1	84€
-----------	--	-----



Colector de escape

Para la evacuación de emisiones a través de un único tubo en el techo de ventilación (diámetro del tubo de escape 180 mm).

70.01.432	Tipo 6-2/1	240€
70.01.586	Tipo 10-2/1	240€



Seguro de flujo para salida de aire

Para la evacuación de emisiones a través de un único tubo en la chimenea (diámetro del tubo de escape 180 mm).

70.01.431	Tipo 6-2/1	283€
70.01.582	Tipo 10-2/1	283€



USB de RATIONAL

42.00.162	Memoria USB 3.0 para programas de cocción y datos APPCC	16€
-----------	---	-----

Accesorios tipo 20-1/1 y 20-2/1



UltraVent (solo para sistemas de cocción eléctricos)

Campana de condensación para fijación y desvío de vapor. No es necesaria una toma externa.

20-1/1: conexión eléctrica 1 NAC 230 V, dimensiones An | P | Al: 880 | 929 | 337 mm

20-2/1: conexión eléctrica 1 NAC 230 V, dimensiones An | P | Al: 1084 | 1134 | 337 mm

60.75.136	Tipo 20-1/1	5.537€
60.75.137	Tipo 20-2/1	7.233€



Campana extractora (solo para sistemas de cocción eléctricos)

Campana de salida para el desvío de los vapores. Requiere una conexión al exterior.

Conexión eléctrica 1 NAC 230 V, dimensiones An | P | Al: 880 | 929 | 383 mm

60.76.219	Tipo 20-1/1	4.319€
-----------	-------------	--------



Rack móvil tipo 20-1/1

Para cargar y descargar con rapidez y gran comodidad un equipo de suelo.

60.21.331	Estándar, 20 guías (distancia entre guías 65 mm)	2.124€
60.21.287	15 guías (distancia entre guías 84 mm)	2.124€
60.21.288	16 guías (distancia entre guías 80 mm)	2.124€
60.21.289	17 guías (distancia entre guías 74 mm)	2.124€
60.21.292	Medidas de panadería (400 × 600 mm), 16 guías (distancia entre guías 81 mm)*	2.124€
60.21.245	20 guías, altura de carga máx. 1,60 m (distancia entre guías 62 mm)	2.124€
60.21.291	20 guías, versión reforzada HeavyDuty/Marine (distancia entre guías 65 mm)	2.336€

* Debe tenerse en cuenta que el deflector en la cámara de cocción del tipo GN y en el tipo de panadería 400 × 600 mm son diferentes. El deflector puede adquirirse como pieza de repuesto a través del servicio técnico.



Rack móvil tipo 20-2/1

Para cargar y descargar con rapidez y gran comodidad un equipo de suelo.

60.22.490	Estándar, 20 guías (distancia entre guías 65 mm)	2.676€
60.22.394	15 guías (distancia entre guías 84 mm)	2.676€
60.22.395	16 guías (distancia entre guías 80 mm)	2.676€
60.22.396	17 guías (distancia entre guías 74 mm)	2.676€
60.22.368	20 guías, altura de carga máx. 1,60 m (distancia entre guías 62 mm)	2.676€
60.22.447	20 guías, versión reforzada HeavyDuty/Marine (distancia entre guías 65 mm)	2.944€



Rack móvil para platos

El rack móvil para platos admite platos preparados (de hasta 31 cm de diámetro) para su regeneración en Finishing.

60.21.293	Tipo 20-1/1, 60 platos	2.515€
60.21.294	Tipo 20-1/1, 50 platos	2.287€
60.22.400	Tipo 20-2/1, 120 platos	3.690€
60.22.399	Tipo 20-2/1, 100 platos	3.536€
60.22.398	Tipo 20-2/1, 84 platos	3.075€

Accesorios tipo 20-1/1 y 20-2/1



Sistemas de Finishing para banquetes

El sistema Finishing contiene todos los accesorios necesarios para poder empezar inmediatamente. Compuesto por rack móvil para platos y Thermocover.

Ahorre hasta el 15 % en comparación con el precio de compra.

60.21.332	Tipo 20-1/1, 60 platos	3.268€
60.21.333	Tipo 20-1/1, 50 platos	3.074€
60.22.493	Tipo 20-2/1, 120 platos	4.691€
60.22.492	Tipo 20-2/1, 100 platos	4.560€
60.22.491	Tipo 20-2/1, 84 platos	4.168€



Thermocover

Gracias al material termoaislante especial los platos se mantienen calientes hasta 20 minutos después del Finishing. Cierre magnético sencillo para abrir y cerrar fácilmente.

6004.1011	Tipo 20-1/1	1.330€
6004.1012	Tipo 20-2/1	1.828€



Kit de drenaje de grasa para rack intercambiable para platos

Solo en combinación con el sistema de drenaje de grasas integrado.

60.75.107	Tipo 20-1/1	1.062€
60.75.108	Tipo 20-2/1	1.338€



Carro de transporte para contenedores

Permite transportar los bidones/recipientes llenos de forma segura.

60.73.309	Carro de transporte para contenedores con drenaje de grasa integrado (Combi-Duo y equipos de suelo)	521€
-----------	---	------



Soporte de asas para rack móvil

Para el almacenamiento seguro del asa del rack móvil. El soporte de asas está incluido en el suministro de los equipos.

60.75.895	Tipos 20-1/1, 20-2/1	21€
-----------	----------------------	-----



Rampa de entrada para rack móvil

Con la rampa de subida se pueden compensar las inclinaciones (hasta 3%) de los suelos de cocina. De esta forma se garantiza la entrada sin choques del rack intercambiable para platos en el equipo RATIONAL.

60.21.262	Tipo 20-1/1	1.380€
60.22.380	Tipo 20-2/1	1.739€



Elemento de elevación del equipo

Se eleva el espacio entre el equipo 70 mm. Solo en combinación con el aumento de la altura del rack móvil para platos.

60.70.407	Tipos 20-1/1, 20-2/1	297€
-----------	----------------------	------

Elemento de elevación para racks móviles

Solo en combinación con una elevación para racks móviles.

60.21.297	Tipo 20-1/1	425€
60.22.386	Tipo 20-2/1	535€

Accesorios tipo 20-1/1 y 20-2/1



Sonda térmica USB

Es posible conectar sondas térmicas externas adicionales fácilmente mediante una conexión USB. La sonda térmica externa permite el control de un plato en iCombi Pro o puede utilizarse como sustituta a la sonda térmica interna en iCombi Classic. La sonda térmica para cocción al vacío permite la cocción con bolsa al vacío con el control exacto de la temperatura del núcleo.

El set de ampliación permite instalar una sonda térmica del núcleo en otro sistema de cocción con arreglo a la normativa de higiene.

60.76.316	Sonda térmica para cocción al vacío para equipos de mesa y equipos de suelo	657€
60.76.318	1 sonda térmica externa para equipos de suelo	548€
60.76.876	Set de ampliación para sonda térmica del núcleo en USB	164€

Elemento auxiliar de posicionamiento para la sonda térmica

Facilita la colocación correcta de la sonda térmica en productos líquidos, blandos o muy pequeños. El elemento auxiliar de colocación puede fijarse en los racks móviles y los bastidores colgantes.

60.71.022	Tipos 6-1/1, 10-1/1, 6-2/1, 10-2/1, 20-1/1 y 20-2/1	15€
-----------	---	-----



Blindaje térmico para panel lateral

La instalación a posteriori del blindaje térmico permite la colocación de fuentes de calor (por ejemplo, una parrilla) cerca del panel lateral del equipo.

60.75.829	Blindaje izquierdo, tipo 20-1/1	376€
60.75.826	Blindaje izquierdo, tipo 20-2/1	473€



Interruptor de condensación

Genera una elevación acelerada del vapor y de otros vahos sacándolos por el tubo de ventilación.

60.75.326	Tipos 20-1/1 y 20-2/1 (Al: 480 mm)	221€
-----------	------------------------------------	------

Fijación en el suelo para sistemas de cocción 20-1/1, 20-2/1

Incluida en el suministro de los sistemas de cocción.

8700.0317	Tipos 20-1/1 y 20-2/1	40€
-----------	-----------------------	-----



Kit de conexión de equipos

Compuesto de manguera de alimentación de agua (2 m) y tuberías de desagüe DN 50.

60.70.464	Tipos XS 6-2/3, 6-1/1, 10-1/1, 6-2/1, 10-2/1, 20-1/1, 20-2/1	84€
-----------	--	-----



Colector de escape

Para la evacuación de emisiones a través de un único tubo en el techo de ventilación (diámetro del tubo de escape 180 mm).

70.01.587	Tipo 20-1/1	313€
70.01.493	Tipo 20-2/1	313€



Seguro de flujo para salida de aire

Para la evacuación de emisiones a través de un único tubo en la chimenea (diámetro del tubo de escape 180 mm).

70.01.583	Tipo 20-1/1	368€
70.01.492	Tipo 20-2/1	368€



USB de RATIONAL

42.00.162	Memoria USB 3.0 para programas de cocción y datos APPCC	16€
-----------	---	-----

Accesorios para la cocción y accesorios especiales

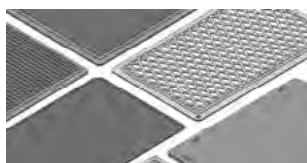

Kit de accesorios

60.76.088	Kit para parrilla – Compuesto de: 1 parrilla con marcas diagonales y en forma de rombo 1/1 GN, 1 bandeja para plancha y asados 1/1 GN, 1 CombiFry 1/1 GN, 1 parrilla de acero inoxidable 1/1 GN	447€
60.76.089	Kit de snacks&tapas – Compuesto de: 3 bandejas para asar y hornear 1/1 GN (sin perforar), 1 Multibaker 1/1 GN, 1 contenedor de granito esmaltado 40 mm 1/1 GN	389€



VarioSmoker

Caja para ahumados con fuente de alimentación, soporte de la fuente de alimentación y cables de conexión. Integración y control a través de los procesos de cocción inteligentes de la conexión iCombi Pro (no disponible para XS 6-2/3) mediante USB. Uso manual en todos los iCombi Pro, iCombi Classic, SelfCookingCenter, CombiMaster Plus y CombiMaster.

Conexión eléctrica de 90 - 240 V, 50/60 Hz, 150 W

60.75.371	VarioSmoker con modelo de enchufe E/F	691€
-----------	---------------------------------------	------

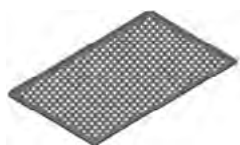

Bandejas de hornear perforadas

Bandeja para hornear termoconductora con revestimiento antiadherente TriLax para un resultado de horneado perfecto a temperaturas de hasta 300 °C.

60.74.147	2/3 GN (325 × 354 mm)	54€
6015.1103	1/1 GN (325 × 530 mm)	70€
6015.2103	2/1 GN (650 × 530 mm)	103€
6015.1000	Medidas de panadería 400 × 600 mm	85€



Bandeja para asar y hornear (sin perforaciones)

Bandeja para hornear termoconductora con revestimiento antiadherente TriLax para un resultado de cocción y horneado perfecto a temperaturas de hasta 300 °C.

60.73.671	2/3 GN (325 × 354 mm)	56€
6013.1103	1/1 GN (325 × 530 mm)	73€
6013.2103	2/1 GN (650 × 530 mm)	109€
6013.1003	Medidas de panadería 400 × 600 mm	89€



Parrilla con marcas diagonales y en forma de rombo

La parrilla con marcas diagonales y en forma de rombo con revestimiento TriLax permite obtener las clásicas marcas de parrilla por un lado o las marcas originales de asador estadounidense en el otro lado.

60.73.802	1/2 GN (325 × 265 mm)	124€
60.73.801	2/3 GN (325 × 354 mm)	127€
60.73.314	1/1 GN (325 × 530 mm)	165€



Bandeja para plancha y asados

Bandeja para plancha y asados multifuncional con revestimiento TriLax, ideal para estampar diagonalmente la marca de parrilla en asados, pescado y verduras. El borde de alrededor de toda la bandeja sirve para asar alimentos que contienen mucha grasa o suelten líquidos.

60.71.617	1/1 GN (325 × 530 mm)	165€
-----------	-----------------------	------



Bandeja para plancha y pizza

Bandeja para plancha y pizza termoconductora con revestimiento antiadherente de TriLax. Ideal para pizzas y pan árabe frescos o precocinados a temperaturas de hasta 300 °C. La otra cara de la bandeja es ideal para cocinar filetes, verdura o pescado a la plancha.

60.73.798	2/3 GN (325 × 354 mm)	140€
60.70.943	1/1 GN (325 × 530 mm)	182€
60.71.237	Medidas de panadería 400 × 600 mm	222€

Accesorios para la cocción y accesorios especiales



Parrilla CombiGrill con cargador

La parrilla CombiGrill con revestimiento antiadherente de TriLax confiere unas marcas de parrilla perfectas a pescados y verduras asadas. No es necesario precalentar.

El Cargador (para parrilla CombiGrill) de acero inoxidable facilita el braseado de grandes cantidades de productos finos en la parrilla CombiGrill precalentada.

6035.1017	Parrilla CombiGrill 1/1 GN (325 × 530 mm)	149€
60.73.848	Parrilla con revestimiento para parrilla CombiGrill 325 × 618 mm (para 1/1 GN (325 × 530 mm))	50€



Sartén para asar y hornear

La base ondulada de la sartén hace que los productos se doren uniformemente y el revestimiento TriLax evita que se peguen. La bandeja de soporte en la que se colocan las sartenes facilita la carga de grandes cantidades.

60.73.286	Juego sartén pequeña (4 unidades, incluye bandeja)	324€
60.73.287	Juego sartén grande (2 unidades, incluye bandeja)	240€
60.73.271	Multi sartén para asar y hornear pequeña (ø 16 cm)	70€
60.73.272	Multi sartén para asar y hornear grande (ø 25 cm)	97€
60.73.212	Bandeja para sartén 1/1 GN para asar y hornear pequeña	45€
60.73.216	Bandeja para sartén 1/1 GN para asar y hornear grande	45€



Multibaker

El Multibaker con revestimiento TriLax sirve para la preparación de grandes cantidades de huevos fritos, tortillas, etc.

60.73.764	1/3 GN (325 × 265 mm) 2 cavidades	57€
60.73.646	2/3 GN (325 × 354 mm) 5 cavidades	85€
60.71.157	1/1 GN (325 × 530 mm) 8 cavidades	110€

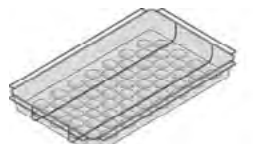

CombiFry

Para la preparación de grandes cantidades de productos prefritos.

6019.1250	1/2 GN (325 × 265 mm)	84€
60.73.619	2/3 GN (325 × 354 mm)	86€
6019.1150	1/1 GN (325 × 530 mm)	112€

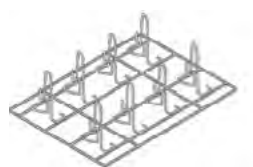

Superspika para pollos y patos

La colocación vertical de las aves hace que la carne de la pechuga salga particularmente tierna crujiente y que la pieza obtenga un dorado atractivo y uniforme.

6035.1015	Capacidad 4 unidades, peso máx. 1300 g, 1/2 GN (325 × 265 mm)	50€
6035.1016	Capacidad 6 unidades, peso máx. 1800 g, 1/1 GN (325 × 530 mm)	60€
6035.1006	Capacidad 8 unidades, peso máx. 1300 g, 1/1 GN (325 × 530 mm)	66€
6035.1010	Capacidad 10 unidades, peso máx. 950 g, 1/1 GN (325 × 530 mm)	76€
6035.1009	Superspika para patos, capacidad 8 unidades, peso máx. 2200 g, 1/1 GN (325 × 530 mm)	119€

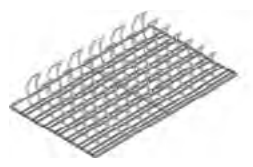

Parrilla para costillas

La colocación vertical de las costillas permite un óptimo aprovechamiento de la capacidad de la parrilla así como la pre cocción perfecta del producto también en cocción nocturna.

6035.1018	1/1 GN (325 × 530 mm)	133€
-----------	-----------------------	------

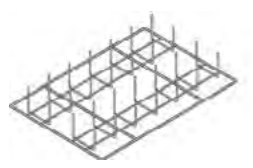

Potato Baker

Con el Potato Baker de RATIONAL podrá preparar patatas al horno o mazorcas de maíz sin papel de plata y hasta un 50 % más rápido.

6035.1019	1/1 GN (325 × 530 mm)	133€
-----------	-----------------------	------

Accesorios para la cocción y accesorios especiales

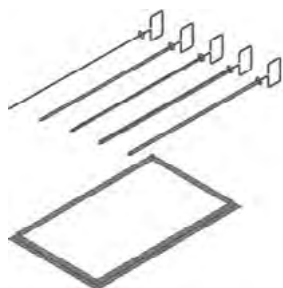

Brochetas para asar y platos tandoori

Brochetas de acero inoxidable y soporte para brochetas a juego para la preparación de piezas de pescado y piezas de ave, pescados enteros o filetes. Extremadamente robustas gracias al acero inoxidable de alta calidad. Fáciles de limpiar en el lavavajillas.

60.75.782	Juego 2/3 GN (325 × 354 mm) (1 rack longitudinal y 5 pinchos distintos)	103€
60.72.414	Juego 1/1 GN (325 × 530 mm) (1 rack longitudinal y 5 pinchos distintos)	144€
60.74.963	Soporte para brochetas para barbacoa y tandoori 2/3 GN (325 × 354 mm)	49€
60.72.224	Soporte para brochetas para barbacoa y tandoori 1/1 GN (325 × 530 mm)	64€
60.75.783	5 pinchos O 5 mm, 265 mm de largo para 2/3 GN (325 × 354 mm)	54€
60.75.784	5 pinchos □ 5 mm, 265 mm de largo para 2/3 GN (325 × 354 mm)	54€
60.75.785	5 pinchos para pescado 4 × 10 mm, 265 mm de largo para 2/3 GN (325 × 354 mm)	59€
60.72.416	3 pinchos O 5 mm, 530 mm de largo para 1/1 GN (325 × 530 mm)	48€
60.72.417	3 pinchos O 8 mm, 530 mm de largo para 1/1 GN (325 × 530 mm)	55€
60.72.418	3 pinchos □ 5 mm, 530 mm de largo para 1/1 GN (325 × 530 mm)	48€
60.72.419	3 pinchos □ 8 mm, 530 mm de largo para 1/1 GN (325 × 530 mm)	55€
60.72.420	3 pinchos para pescado 4 × 10 mm, 530 mm de largo para 1/1 GN (325 × 530 mm)	55€



Molde para muffins y timbales

Los moldes para magdalenas y timbales están fabricados de un material sumamente flexible. Se prestan también de manera idónea para la preparación de pasteles de verdura, timbales de pescado, pudín, diversos tipos de postres, huevos escalfados y otras exquisiteces. Capacidad: aprox. 100 ml.

6017.1002	300 × 400 mm (para 1/1 GN (325 × 530 mm))	94€
6017.1001	400 × 600 mm (para 2/1 GN (650 × 530 mm) y medidas de panadería)	173€



Contenedores de granito esmaltado

Muy buena conductividad térmica que procura un dorado uniforme. Esquinas bien formadas del contenedor que permiten también la distribución de las piezas angulares. Especialmente indicados para bizcochos rectangulares, masa batida y pizzas rectangulares.

6014.1202	1/2 GN (325 × 265 mm), 20 mm de profundidad	69€
6014.1204	1/2 GN (325 × 265 mm), 40 mm de profundidad	76€
6014.1206	1/2 GN (325 × 265 mm), 60 mm de profundidad	94€
6014.2302	2/3 GN (325 × 354 mm), 20 mm de profundidad	71€
6014.2304	2/3 GN (325 × 354 mm), 40 mm de profundidad	78€
6014.2306	2/3 GN (325 × 354 mm), 60 mm de profundidad	96€
6014.2310	2/3 GN (325 × 354 mm), 100 mm de profundidad	121€
6014.1102	1/1 GN (325 × 530 mm), 20 mm de profundidad	92€
6014.1104	1/1 GN (325 × 530 mm), 40 mm de profundidad	102€
6014.1106	1/1 GN (325 × 530 mm), 60 mm de profundidad	125€
6014.1110	1/1 GN (325 × 530 mm), 100 mm de profundidad	157€
6014.2102	2/1 GN (650 × 530 mm), 20 mm de profundidad	137€
6014.2104	2/1 GN (650 × 530 mm), 40 mm de profundidad	150€
6014.2106	2/1 GN (650 × 530 mm), 60 mm de profundidad	185€
6014.1002	Medidas de panadería 400 × 600 mm, 20 mm de profundidad	113€
6014.1004	Medidas de panadería 400 × 600 mm, 40 mm de profundidad	124€
6014.1006	Medidas de panadería 400 × 600 mm, 60 mm de profundidad	152€



Molde para pizza

Molde de pizza para rack móvil para platos para hornear pizzas precocinadas en el menor tiempo posible. Cargar los moldes de pizza fácilmente en el rack móvil para platos y terminar de hornear con Finishing.

60.71.158	Pizza de hasta Ø 280 mm	26€
-----------	-------------------------	-----

Accesorios para la cocción y accesorios especiales



Espadín para cordero y cochinillo (1 para cordero o 1 para cochinillo)

Para la preparación de corderos y cochinillos enteros. Fácil de colocar y colgar.

60.70.819	Tipos 10-1/1, 10-2/1, 20-1/1, 20-2/1 hasta 12 kg (1/1 GN (325 × 530 mm))	167€
6035.1003	Tipo 20-1/1 hasta 30 kg (1 espadín con soporte)	561€
6035.1002	Tipo 20-2/1 hasta 30 kg (1 espadín con soporte, segundo espadín para cordero o cochinillo opcional)	587€
8710.1065	Espadín opcional	243€



Colector de grasa con cierre de desagüe (incluye tapa y manguera purgadora)

Ideal para recoger la grasa al asar a la parrilla y sofreír. El colector de grasa puede vaciarse de forma fácil y segura con la válvula esférica cerrable y la manguera purgadora.

8710.1135	1/1 GN (325 × 530 mm)	392€
60.70.776	2/1 GN (650 × 530 mm)	581€



Bastidor colgante para pato laqueado a la pekinesa

El bastidor colgante especial para sistemas de cocción 10-1/1 permite una carga óptima con se cocinan en posición colgada como, por ejemplo, el pato laqueado a la pekinesa. La bandeja para alojar la parrilla de acero inoxidable en la que se pueden sujetar fácilmente los alimentos. Incluye en el paquete. Guía inferior para colocar un contenedor que recoja la grasa saliente.

60.76.307	Juego de bastidor colgante para pato laqueado (bastidor colgante y parrilla 400 × 600 mm)	709€
-----------	---	------

Contenedores Gastronorm

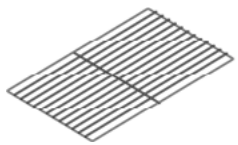

Parrilla de acero inoxidable

6010.2301	2/3 GN (325 × 354 mm)	35€
6010.1101	1/1 GN (325 × 530 mm)	45€
6010.2101	2/1 GN (650 × 530 mm)	77€
6010.0103	Medidas de panadería 400 × 600 mm	56€



Recipiente, acero inoxidable

El espesor del material de los contenedores RATIONAL supera en un 33 % a la media. Esto garantiza una máxima estabilidad incluso con grandes cantidades de llenado y una larga vida útil. Los contenedores apilables garantizan el ahorro de espacio.

6013.2302	2/3 GN (325 × 354 mm), 20 mm de profundidad	27€
6013.2306	2/3 GN (325 × 354 mm), 65 mm de profundidad	40€
6013.1102	1/1 GN (325 × 530 mm), 20 mm de profundidad	36€
6013.1104	1/1 GN (325 × 530 mm), 40 mm de profundidad	45€
6013.1106	1/1 GN (325 × 530 mm), 65 mm de profundidad	52€



Contenedores perforados, acero inoxidable

6015.1165	1/1 GN (325 × 530 mm), 55 mm de profundidad	55€
-----------	---	-----

Paquetes de compatibilidad iCombi

Aseguran el uso de los accesorios en diferentes generaciones de equipos.

Tipo 6-1/1 y 10-1/1

El paquete de compatibilidad compuesto por las guías de inserción y los carros de transporte asegura la posibilidad de usar los nuevos racks móviles también en equipos de generaciones anteriores a partir de 2004.

60.61.745	Paquete de compatibilidad con carro de transporte estándar, dimensiones An P Al: 525 911 990 mm para equipos de sobremesa	1.093€
60.61.746	Paquete de compatibilidad con carro de transporte de altura regulable, dimensiones An P Al: 525 911 800-1330 mm para equipos de sobremesa	1.635€

Tipo 6-2/1 y 10-2/1

El paquete de compatibilidad compuesto por las guías de inserción y los carros de transporte asegura la posibilidad de usar los nuevos racks móviles.

60.62.197	Paquete de compatibilidad con carro de transporte estándar, dimensiones An P Al: 735 996 990 mm para equipos de sobremesa	1.386€
-----------	---	--------

Tipo 20-1/1

El paquete de compatibilidad compuesto por las guías de centrado, la elevación del equipo y los racks móviles asegura el uso de los nuevos racks móviles.

60.21.335	Paquete de compatibilidad con rack móvil para 20 guías, altura de carga máx. 1,60 m (distancia entre guías 62 mm) para equipos de suelo	2.124€
60.21.336	Paquete de compatibilidad con rack móvil estándar, 20 guías (distancia entre guías 65 mm) para equipos de suelo	2.124€
60.21.337	Paquete de compatibilidad con rack móvil, 15 guías (distancia entre guías 84 mm) para equipos de suelo	2.124€
60.21.338	Paquete de compatibilidad con rack móvil, 16 guías (distancia entre guías 80 mm) para equipos de suelo	2.124€
60.21.339	Paquete de compatibilidad con rack móvil de medidas de panadería, 16 guías (distancia entre guías 81 mm) para equipos de suelo	2.124€
60.21.340	Paquete de compatibilidad con rack móvil para platos tipo 20-1/1, 60 platos para equipos de suelo	2.515€
60.21.341	Paquete de compatibilidad con rack móvil para platos tipo 20-1/1, 50 platos para equipos de suelo	2.287€

Tipo 20-2/1

El paquete de compatibilidad compuesto por las guías de centrado, la elevación del equipo y los racks móviles asegura el uso de los nuevos racks móviles.

60.22.497	Paquete de compatibilidad con rack móvil para 20 guías, altura de carga máx. 1,60 m (distancia entre guías 62 mm) para equipos de suelo	2.676€
60.22.498	Paquete de compatibilidad con rack móvil estándar, 20 guías (distancia entre guías 65 mm) para equipos de suelo	2.676€
60.22.499	Paquete de compatibilidad con rack móvil, 15 guías (distancia entre guías 84 mm) para equipos de suelo	2.676€
60.22.500	Paquete de compatibilidad con rack móvil para platos tipo 20-2/1, 84 platos para equipos de suelo	3.075€
60.22.501	Paquete de compatibilidad con rack móvil para platos tipo 20-2/1, 100 platos para equipos de suelo	3.536€
60.22.502	Paquete de compatibilidad con rack móvil para platos tipo 20-2/1, 120 platos para equipos de suelo	3.690€

Kit de adaptación

Para la instalación de un UltraVent, UltraVent Plus o una campana extractora en un SelfCookingCenter o CombiMaster Plus. SelfCookingCenter o CombiMaster Plus desde 09/2011 hasta 05/2020

60.75.148	Kit de adaptación para tipos 61 y 101, solo equipos individuales de versión eléctrica	412€
60.75.149	Kit de adaptación para tipo 62, solo equipos individuales de versión eléctrica	412€
60.76.604	Kit de adaptación para tipo 102, solo equipos individuales de versión eléctrica	412€
60.75.150	Kit de adaptación para tipo 201, solo equipos eléctricos	412€
60.75.151	Kit de adaptación para tipo 202, solo equipos eléctricos	412€

SelfCookingCenter o CombiMaster Plus desde 04/2004 hasta 09/2011

60.76.837	Kit de adaptación para tipos 61 y 101, solo equipos individuales con versión eléctrica	473€
-----------	--	------

Memoria USB RATIONAL

USB 2.0 para programas de cocción y datos APPCC, para SelfCookingCenter y CombiMaster Plus.

42.00.386	USB 2.0	22€
-----------	---------	-----

Paquetes de compatibilidad de Combi-Duo universal

iCombi con SelfCookingCenter o CombiMaster Plus desde 2004

Seleccione un kit para Combi-Duo y el sistema de ventilación correspondiente para el equipo inferior.

		Equipo inferior	Sistema de cocción iCombi superior					Sistema de ventilación del equipo inferior	
			Versión eléctrica		Versión para gas				
			XS 6-2/3	6-1/1	6-2/1	6-1/1	6-2/1		
SelfCookingCenter o CombiMaster Plus desde 09/2011 hasta 05/2020	Apertura hacia la derecha	Versión eléctrica	XS	A	-	-	-	-	
			61	P*	N	-	N	-	V*
			101	P*	N	-	N	-	V*
			62	Q*	Q*	O	Q*	O	V*
		102	Q*	-	O	-	O	V*	
		Versión para gas	61	P	P	-	P	-	T
			101	P	-	-	-	-	T
			62	Q	Q	Q	Q	Q	T
	102		Q	-	-	-	-	T	
	Apertura a la izquierda	Versión eléctrica	XS	B	-	-	-	-	
			61	R	R	-	R	-	V
			101	R	-	-	-	-	V
			62	S	S	S	S	S	V
		102	S	-	-	-	-	V	
Versión para gas		61	R	R	-	R	-	T	
		101	R	-	-	-	-	T	
		62	S	S	S	S	S	T	
	102	S	-	-	-	-	T		
SelfCookingCenter o CombiMaster Plus desde 04/2004 hasta 09/2011	Apertura hacia la derecha	Versión eléctrica	61	P	P	-	P	-	W
			62	Q	Q	Q	Q	Q	W
		Versión para gas	61	P	P	-	P	-	U
			62	Q	Q	Q	Q	Q	U
	Apertura a la izquierda	Versión eléctrica	61	R	R	-	R	-	W
			62	S	S	S	S	S	W
		Versión para gas	61	R	R	-	R	-	U
			62	S	S	S	S	S	U

A	60.73.768	Combi-Duo tipo XS 6-2/3 sobre tipo XS 6-2/3 apertura hacia la derecha	670€
B	60.74.276	Combi-Duo tipo XS 6-2/3 sobre tipo XS 6-2/3 apertura hacia la izquierda	670€
N	60.76.500	Combi-Duo, tipo 6-1/1 eléctrico/gas sobre tipo 61, 101 versión eléctrica con apertura hacia la derecha, tipo compatible	914€
O	60.76.575	Combi-Duo, tipo 6-2/1 eléctrico/gas sobre tipo 62, 102 versión eléctrica con apertura hacia la derecha, tipo compatible	1.188€
P	60.74.524	Combi-Duo Universal, tipo XS 6-2/3 o tipo 6-1/1 eléctrico/gas sobre tipo 61, versión eléctrica/gas con apertura hacia la derecha, tipo compatible	1.132€
Q	60.74.797	Combi-Duo Universal, tipo XS 6-2/3 o tipo 6-1/1 eléctrico/gas sobre tipo 62, versión eléctrica/gas con apertura hacia la derecha, tipo compatible	1.471€
R	60.74.930	Combi-Duo Universal, tipo XS 6-2/3 o tipo 6-1/1 eléctrico/gas sobre tipo 61 versión eléctrica/gas con apertura hacia la izquierda, tipo compatible	1.132€
S	60.74.953	Combi-Duo Universal, tipo XS 6-2/3 o tipo 6-1/1 eléctrico/gas sobre tipo 62 versión eléctrica/gas con apertura hacia la izquierda, tipo compatible	1.471€
T	60.76.756	Cajas de gas de escape tipo 61, 101, 62, 102 gas desde 09/2011 hasta 05/2020	198€
U	60.76.757	Cajas de gas de escape tipo 61, 101, 62, 102 gas desde 04/2004 hasta 09/2011	198€
V	60.76.733	Tubo de ventilación tipo 61, 101, 62, 102 eléctrico desde 09/2011 hasta 05/2020	130€
W	60.76.735	Tubo de ventilación tipo 61, 101, 62, 102 eléctrico desde 04/2004 hasta 09/2011	130€

* El tubo de ventilación Elektro V solo se necesita para los kits Combi-Duo P y Q.

Paquetes de compatibilidad de Combi-Duo universal

Kit de adaptación para campanas extractoras Combi-Duo

Para la instalación en un Combi-Duo con iCombi sobre un SelfCookignCenter o CombiMaster Plus fabricado desde 09/2011 hasta 05/2020.

60.76.659	Tipo 61, 101, 62 y 102 versión eléctrica	412€
-----------	--	------

Para la instalación en un Combi-Duo con iCombi sobre un SelfCookignCenter o CombiMaster Plus fabricado desde 04/2004 hasta 09/2011.

60.76.883	Tipo 61, 101, 62 y 102 versión eléctrica	473€
-----------	--	------

Variantes de subestructura para la combinación de un iCombi con un SelfCookingCenter o CombiMaster Plus

Seleccione una de las opciones siguientes en el caso de utilizar una configuración Combi-Duo nueva.

El equipo inferior es un SelfCookingCenter o CombiMaster Plus tipo 61 o tipo 101

60.60.349	Con patas	358€
60.60.968	Móvil con ruedas	888€
60.31.649	Mesa I para Combi-Duo tipo 61 sobre tipo 61	659€

El equipo inferior es un SelfCookingCenter o CombiMaster Plus tipo 62 o tipo 102

60.60.392	Con patas	408€
60.60.513	Móvil con ruedas	979€
60.31.650	Mesa I para Combi-Duo tipo 62 sobre tipo 62	751€

Símbolo de homologación para iCombi

Los sellos de calidad siguientes confirman que nuestros sistemas de cocción cumplen las directrices y estándares establecidos de los organismos independientes de evaluación y certificación. De esta manera, verá de un vistazo que se cumplen los aspectos relevantes en materia de seguridad a escala nacional e internacional, el valor que le damos a la excelencia en la calidad del producto y el cumplimiento demostrable. También encontrará más información en rational-online.com.



La conformidad CE define los requisitos de calidad fundamentales de los productos que se ponen en circulación en el mercado europeo.



EnergyStar es un programa de etiquetado internacional y voluntario. Certifica los productos especialmente eficientes en materia de energía basándose en criterios de eficiencia de la EPA y el Ministerio de Energía de EE. UU.



El KIWA se centra en el mercado europeo y la verificación, inspección y certificación de equipos en el sector eléctrico, del gas y el agua. Además, los equipos se verifican conforme a los requisitos establecidos en materia de calidad y seguridad.



El NSF-HCV certifica la seguridad higiénica de los equipos destinados a la elaboración de alimentos en Europa.



El CSA es un símbolo de homologación estadounidense que garantiza el cumplimiento pleno de todas las normas relevantes con relación a la homologación de gas en la introducción en el mercado de equipos nuevos.



La NSF garantiza el cumplimiento internacional de las normas de higiene NSF/ANSI en el lanzamiento al mercado de nuevos equipos.



UL evalúa y certifica la seguridad de los productos electrónicos que se comercializan en EE. UU.



QA es una marca de calidad para los equipos de gas en los Países Bajos, que certifica que los equipos cumplen los requisitos establecidos en materia de calidad, funcionalidad y seguridad.



Este certificado define los requisitos de los equipos en los sectores del gas y el agua con respecto a la calidad, la seguridad y las características de uso para el mercado suizo.



La EAC establece los requisitos más importantes para los equipos conforme a los requisitos de calidad y seguridad euroasiáticos.



Los equipos electrónicos diseñados para el mercado japonés deben cumplir los requisitos determinados por las normas de seguridad del PSE.



JIA certifica el cumplimiento de los requisitos establecidos en materia de protección del agua potable en el mercado japonés.



El organismo de control JIA somete a ensayo y certifica los equipos de gas para el mercado japonés.



La KTL se refiere al mercado coreano y confirma el cumplimiento de los requisitos de seguridad del producto para los equipos electrónicos.



KGS certifica los requisitos básicos de una entrada de gas conforme a las normas coreanas.



Watermark certifica los equipos para el mercado australiano con el fin de asegurarse de que son adecuados para su uso y cuentan con la autorización a tal efecto.



AGA es de aplicación para el mercado australiano y se asegura de que los equipos de gas cumplan las normas de seguridad australianas relativas al gas.



INMETRO se refiere a todos los equipos o componentes eléctricos con una potencia de conexión inferior a 20 kW en Brasil.



IRAM especifica las disposiciones relativas a la autorización para el mercado argentino, centrándose en la electrónica, el gas, la mecánica, la higiene, la seguridad y los alimentos.



La DNV GL es una sociedad de clasificación internacional que certifica los modelos para embarcaciones de los equipos.

Características del equipamiento iCombi

Funciones	iCombi Pro			iCombi Classic	
	XS 6-2/3	6-1/1 10-1/1 6-2/1 10-2/1	20-1/1 20-2/1	6-1/1 10-1/1 6-2/1 10-2/1	20-1/1 20-2/1
iCookingSuite con los modos de funcionamiento Aves, Carne, Pescado, Platos con huevos, Guarniciones, Panadería tradicional y Finishing, así como los procesos de cocción Cocer, Sofreír, Hornear y Plancha, para introducir de forma sencilla el resultado deseado con el ajuste automático del proceso de cocción y horneado ideal.	●	●	●	–	–
Configuración predeterminada específica del país de los parámetros de cocción, independientemente del idioma de usuario seleccionado. Selección de ejemplos de aplicación con configuración predeterminada para otros países.	●	●	●	–	–
Cockpit: Indicación del paso de cocción del proceso de cocción inteligente en curso. Marca del paso de cocción actual.	●	●	●	–	–
Messenger – Informa sobre los ajustes automáticos actuales del proceso de cocinado y horneado e indica los requisitos de manejo en una ventana emergente	●	●	●	–	–
Función de enfriamiento automático Cool-Down para una preparación inteligente del clima con inyección de agua (opcional) para un enfriamiento más rápido	●	●	●	–	–
Función Cool Down seleccionable manualmente para el enfriamiento rápido y seguro de la cámara de cocción	●	●	●	●	●
Es posible realizar una intervención activa en los procesos de cocción inteligente en curso y ajustar los parámetros de cocción en cualquier momento	●	●	●	–	–
Cambio de procesos de cocción inteligente en iProductionManager o en la cocción manual. Cambio entre cocción manual y iProductionManager	●	●	●	–	–
iProductionManager – Organización inteligente y flexible de todo el proceso de producción. Indicación de qué productos pueden elaborarse juntos y supervisión individual de la carga de las diferentes bandejas y también la carga mixta. Aviso de cuándo debe cargar una comida o sacarla del equipo. Posicionamiento de las comandas en el momento actual o en el futuro, ordenación automática optimizada en el menor tiempo posible o con un consumo de energía mínimo. Como alternativa: Distribución de las comandas para la terminación de los platos en un tiempo determinado seleccionado.	●	●	●	–	–
Señalización de bandejas iProductionManager – Señalización de las guías que deben cargarse o descargarse iCookingSuite o modo manual – Señalización de los pasos de cocción como el final del Precalentamiento, el final del proceso de cocción o las indicaciones de manejo mediante la iluminación LED	–	●	–	–	–
Gestión inteligente de precalentamiento y carga: carga inmediata, según producto, sin esperas y con el mejor resultado de cocción	●	●	●	–	–
iDensityControl – La gestión del clima inteligente establece siempre la temperatura adecuada de la zona de cocción mediante sensores inteligentes, el sistema de calentamiento de alto rendimiento, el generador de vapor fresco y la deshumidificación activa. La fluidización inteligente del aire pone a disposición la energía allí donde se necesite.	●	●	●	–	–
ClimaPlus – Medición, configuración en 10 niveles y regulación de la humedad con exactitud porcentual	–	–	–	●	●
Deshumidificación activa de la cámara de cocción: hasta 105 l por segundo para el mejor resultado de cocción	●	●	●	●	●
Modo de vaporizador combinado con los modos de funcionamiento: Vapor 30 °C–130 °C, aire caliente 30 °C–300 °C, combinación de vapor y aire caliente 30 °C–300 °C	●	●	●	●	●
Proceso Finishing inteligente y automático para emplatado en banquetes, bufets, servicio a la carta, etc.	●	●	●	–	–
Programas Finishing para emplatado en banquetes y recipientes	–	–	–	●	●
Cocción a baja temperatura (también durante la noche)	●	●	●	–	–
Cocción Delta T para la cocción delicada de piezas de carne grandes, también durante la noche	●	●	●	●	●
Proceso de ahumado inteligente con el VarioSmoker (no recomendado para 20-2/1)	–	●	●	–	–

● Estándar | ○ Opcional | – No disponible | □ Accesorios

Características del equipamiento iCombi

Manejo	iCombi Pro			iCombi Classic	
	XS 6-2/3	6-1/1 10-1/1 6-2/1 10-2/1	20-1/1 20-2/1	6-1/1 10-1/1 6-2/1 10-2/1	20-1/1 20-2/1
Lista de los favoritos Top 10 entre los procesos de cocción seleccionados de iCookingSuite y los programas manuales, fácil de encontrar bajo la estrella de favoritos en la pantalla de inicio	●	●	●	–	–
Amplias posibilidades de ajuste para adaptación individual a las rutinas de uso	●	●	●	–	–
Creación de perfiles MyDisplay específicos del usuario para una configuración individual de los equipos y el manejo, p. ej., la pantalla de inicio individual	●	●	●	–	–
Pantalla autoconfigurable, personalizable (imágenes, texto, etc.)	●	●	●	–	–
Posibilidad de configurar el tono de la señal acústica y el contraste de pantalla	●	●	●	–	–
Amplias posibilidades de ajuste como el ajuste de la energía, el idioma, la red y el sistema	●	●	●	–	–
Pantalla TFT a color de 10,1 pulgadas con pantalla táctil de cristal, con símbolos explicativos para un manejo sencillo e intuitivo y un control deslizan-do	●	●	●	–	–
Rosca central de ajuste con función «Push» para configurar y confirmar los datos introducidos. Posibilidad de desplazamiento adicional por las listas y selección de procesos de cocción a presión	●	●	●	●	●
Pantalla a color de 4,3" con símbolos explicativos y teclas programables para un manejo sencillo	–	–	–	●	●
Bloqueo de manejo y programación ajustable por tipo de usuario configurado (3 niveles)	●	●	●	–	–
Bloqueo de programa	–	–	–	–	–
Manual de instrucciones electrónico con consejos prácticos y variedad de ejemplos de aplicación que se inician directamente como proceso de cocción desde el manual	●	●	●	–	–
Manejo ergonómico de otro iCombi Pro equipo con la pantalla de otro iCombi Pro p. ej., un Combi-Duo	●	●	●	–	–
Supervisión a distancia de los sistemas de cocción desde el ordenador, smartphone o tablet mediante ConnectedCooking	●	●	●	–	–
Supervisión de los sistemas de cocción desde el ordenador, smartphone o tablet mediante ConnectedCooking	–	–	–	○	○
Instrucciones disponibles en más de 55 idiomas	●	●	●	–	–
Instrucciones sobre símbolos informativos	●	●	●	●	●
Mando de ajuste para los modos de cocción, temperatura, temperatura del núcleo y la hora.	–	–	–	–	–

● Estándar | ○ Opcional | – No disponible | □ Accesorios

Características del equipamiento iCombi

Limpieza, mantenimiento y seguridad operacional	iCombi Pro			iCombi Classic	
	XS 6-2/3	6-1/1 10-1/1 6-2/1 10-2/1	20-1/1 20-2/1	6-1/1 10-1/1 6-2/1 10-2/1	20-1/1 20-2/1
iCareSystem – Sistema de limpieza y descalcificación inteligente con detección del estado de suciedad actual y recomendación de la fase de limpieza y la cantidad de productos ideal	●	●	●	–	–
Limpieza intermedia ultrarrápida en 12 minutos (iCombi Pro XS 6-2/3: <30 minutos)	●	●	●	–	–
Limpieza ligera, media e intensa, en programas normales o ecológicos que cuidan el medio ambiente	●	●	●	–	–
Lavado con y sin pastillas	●	●	●	–	–
Descalcificación automática - El desendurecimiento del agua no es necesario, se suprime la descalcificación manual del generador de vapor	●	●	●	●	●
Aviso automático de limpieza dependiendo de la rutina de uso	●	●	●	–	–
Indicación del estado actual de limpieza y el tiempo de limpieza restante	●	●	●	–	–
Plan semanal de limpieza – Plan semanal de limpieza ajustable para la limpieza del sistema de cocción	●	●	●	–	–
Control y supervisión de la limpieza desde el ordenador, smartphone o tablet mediante ConnectedCooking	●	●	●	–	–
Limpieza automática con el sistema Care – Sistema de limpieza y cuidado para la cámara de cocción y el generador de vapor	–	–	–	●	●
4 programas de limpieza automáticos – Limpieza ligera, media o intensa, lavado sin pastillas	–	–	–	●	●
Visualización de la cantidad de pastillas de detergente Active Green y pastillas Care recomendadas en función del programa de limpieza	●	●	●	●	●
Indicación del programa de limpieza seleccionado y del tiempo de limpieza restante	–	–	–	●	●
Productos de limpieza y cuidado sólidos para la máxima seguridad operativa	●	●	●	●	●
Pastillas de detergente Active Green (paquete promocional) y pastillas Care (paquete promocional)	●	●	●	●	●
Pastillas de detergente (paquete promocional) y pastillas de abrillantador (paquete promocional)	–	–	–	–	–
Ducha de mano integrada y de manejo ergonómico con dispositivo recogedor automático, presión de salida intercambiable (puntos y chorro de ducha) y función de bloqueo de agua integrada	–	●	●	●	●
Ducha de mano integrada con dispositivo recogedor automático, función de corte de agua integrada y dosificación sin escalonamiento del chorro de agua	●	–	–	–	–
Indicación de solicitud de descalcificación	–	–	–	–	–
Programa de descalcificación guiado por menú	–	–	–	–	–
ServiceDiagnose-System (SDS) con visualización automática de los mensajes de servicio	●	●	●	●	●

● Estándar | ○ Opcional | – No disponible | □ Accesorios

Características del equipamiento iCombi

Características del equipamiento	iCombi Pro			iCombi Classic	
	XS 6-2/3	6-1/1 10-1/1 6-2/1 10-2/1	20-1/1 20-2/1	6-1/1 10-1/1 6-2/1 10-2/1	20-1/1 20-2/1
Sonda térmica con 6 puntos de medición	●	●	●	–	–
Sonda térmica con 1 puntos de medición	–	–	–	●	●
Establecimiento individual de la temperatura de núcleo mínima y máxima seleccionable en la configuración del sistema	●	●	●	–	–
Elemento auxiliar de posicionamiento para la sonda térmica	●	□	□	□	□
Sonda térmica externa con conexión USB	–	□	□	□	□
Sonda térmica USB externa sous-vide para cocción al vacío	–	□	□	□	□
1.200 programas hasta con 12 pasos que pueden programarse y designarse libremente	●	●	●	–	–
100 programas con hasta 12 pasos que pueden programarse y designarse libremente	–	–	–	●	●
100 programas con hasta 6 pasos programables libremente	–	–	–	–	–
Inyección manual de vapor	●	●	●	–	–
Humidificación precisa manual programable en 4 niveles desde 30 °C–260 °C con calor seco o combinado	●	●	●	–	–
5 velocidades de circulación del aire, programables	●	●	●	●	●
Procesos de cocción inteligente con detección de carga automática	●	●	●	–	–
Posibilidad de seleccionar entre °C o °F	●	●	●	●	●
Visualización digital de los valores de temperatura	●	●	●	●	●
Visualización de valores efectivos y valores seleccionados	●	●	●	●	●
Reloj programador digital, 0 -24 horas con posición permanente	●	●	●	●	●
Indicación en tiempo real (24 horas)	●	●	●	●	●
Ajuste de la hora en horas/minutos o minutos/segundos	●	●	●	–	–
Ajuste de la hora en horas/minutos	–	–	–	●	●
Preselección automática de la hora de arranque con programación variable de fecha y hora	●	●	●	–	–
Generador de vapor fresco de alto rendimiento con función automática de llenado de agua	●	●	●	●	●
Sistema de combustión silencioso con ventilador de alta capacidad (solo equipos de gas)	–	●	●	●	●
Sistema de deshumidificación automática	●	●	●	●	●
Fluidización dinámica del aire con rosca del ventilador de alto rendimiento (6 guías: 1 turbina, 10 guías: 2 turbinas, 20 guías: 3 turbinas)	●	●	●	●	●
Adaptación automática a las características del lugar de instalación (altitud, etc.), incluyendo autocomprobación inicial	●	●	●	●	●
Ajuste automático a la altura geográfica del modo de funcionamiento Vapor para el mejor resultado con vapor	●	●	●	●	●
Demanda de energía en función de la necesidad	●	●	●	●	●
Deflector extraíble	●	●	●	●	●
Freno de turbina integrado para más seguridad en la operación y rápido cambio en el sentido de giro	●	●	●	●	●
Separación centrífuga de grasa sin necesidad de filtro adicional	●	●	●	●	●
Puerta de la cámara de cocción con triple acristalamiento con ventilación posterior, revestimiento especial termorreflectante y cristales interiores orientables para una limpieza sencilla	●	●	●	–	–
Puerta de la cámara de cocción con doble acristalamiento con ventilación posterior, revestimiento especial termorreflectante y cristales interiores orientables para una limpieza sencilla	–	–	–	●	●
Posiciones de bloqueo de la puerta a 110°/180° (equipos de sobremesa), 120°/180° (equipos de suelo) para la máxima seguridad operativa	●	●	●	●	●
Interruptor de puerta de contacto por proximidad	●	●	●	●	●
Control de los tiempos de apertura de la puerta durante la carga y la cocción con función de alarma	●	●	●	–	–
Marcha en inercia de una campana extractora o de condensación de RATIONAL de selección libre	●	●	●	–	–
Burlete insertable, fácil de cambiar	●	●	●	●	●

Características del equipamiento iCombi

Características del equipamiento	iCombi Pro			iCombi Classic	
	XS 6-2/3	6-1/1 10-1/1 6-2/1 10-2/1	20-1/1 20-2/1	6-1/1 10-1/1 6-2/1 10-2/1	20-1/1 20-2/1
Ayudas de inserción lateral para racks móviles	–	–	●	–	●
Bandeja longitudinal tipo XS 6-2/3 indicada para contenedores GN 1/2, 1/3, 2/3, pérdidas de energía mínimas y necesidad mínima de espacio al abrir y girar la puerta	●	–	–	–	–
Bandeja longitudinal tipo 6-1/1, 10-1/1, 20-1/1 indicada para contenedores GN 1/1, 1/2, 1/3, 2/3, pérdidas de energía mínimas y necesidad mínima de espacio al abrir y girar la puerta	–	●	●	●	●
Bandeja longitudinal tipo 6-1/1 y 10-1/1 indicada para medidas de panadería (400 × 600 mm) pérdidas de energía mínimas y necesidad mínima de espacio al abrir y girar la puerta	–	○	–	○	–
Bandeja longitudinal tipo 6-2/1, 10-2/1, 20-2/1 indicada para contenedores GN 2/1, 1/1, 2/4 GN, pérdidas de energía mínimas y necesidad mínima de espacio al abrir y girar la puerta	–	●	●	●	●
Cámara de cocción higiénica, cubiforme, sin juntas, esquinas redondeadas, protección contra salpicaduras	●	●	●	●	●
LED de cámara de cocción e iluminación de bandejas	●	●	●	●	●
Bastidores extraíbles con guía adicional para el colector de grasa	–	●	–	●	–
Bastidores extraíbles y orientables	●	–	–	–	–
Guías de inserción en forma de U con entalladuras para facilitar la carga	–	●	●	●	●
Guías de inserción en forma de L	–	○	–	○	–
Paquete de racks móviles	–	○	–	○	–
Paquete de racks móviles para Combi-Duo	–	○	–	○	–
Rack intercambiable bloqueable por ambos lados, bandeja colector con vaciado, ruedas tándem (2 con freno), diámetro 125 mm, componentes metálicos de acero inoxidable	–	–	●	–	●
Puerta de la cámara de cocción con mecánica de obturación integrada y optimizada; evita la salida de vapor cuando se trabaja sin rack móvil	–	–	●	–	●
Material interior y exterior: acero inoxidable DIN 1.4301	●	●	●	●	●
Interfaz USB para la descarga de datos APPCC y servicio, así como para descargar programas de cocción a un USB RATIONAL y para actualizar fácilmente el software del equipo	●	●	●	●	●
Carga de cestas, carga de imágenes a través de la interfaz USB para personalizar la página inicial	●	●	●	–	–
Visualización de mensajes de servicio y advertencias, por ejemplo: falta de agua	●	●	●	●	●

● Estándar | ○ Opcional | – No disponible | □ Accesorios

Características del equipamiento iCombi

Conexión, instalación y símbolos de homologación	iCombi Pro			iCombi Classic	
	XS 6-2/3	6-1/1 10-1/1 6-2/1 10-2/1	20-1/1 20-2/1	6-1/1 10-1/1 6-2/1 10-2/1	20-1/1 20-2/1
Posibilidad de conexión a sistemas de optimización de energía (solo para tensiones 3 NCA 400 V y 3 NCA 415 V)	○	○	○	○	○
Toma para indicador de operaciones / contactos sin potencial, p. ej., para aparatos de ventilación internos o transductores de señales	○	○	○	–	–
Interfaz Wi-Fi para el uso de la moderna solución de conectividad basada en la nube ConnectedCooking	●	●	●	○	○
Puerto Ethernet para conexión a ConnectedCooking	●	●	●	○	○
Declaración de conformidad: CE	●	●	●	●	●
Seguridad eléctrica: Kiwa, UL, CUL, IRAM, EAC, EMC, PSE, KTL, INMETRO	●	●	●	●	●
Eficiencia energética: Energy Star	●	●	●	●*	–
Seguridad de la instalación del gas: Gastec QA, AGA, CSA, SVGW, JIA, EAC, KGS, SABS, SVCOO	–	●	●	●	●
Seguridad de equipos y operativa: comprobados conforme la Directiva sobre máquinas 2006/42/CE	●	●	●	●	●
Higiene general: NSF, HCV-EU	●	●	●	●	●
Certificado kosher para sistemas de cocción y limpiadores	●	●	●	●	●
Protección del agua potable: SVGW, KIWA, EN1717, JET, Watermark	●	●	●	●	●
Germanischer Lloyd DNV GL	●	●	●	●	●
Accesorios de cocción aptos para alimentos conforme a VO 1935/2004/CE	●	●	●	●	●
Toma fija para aguas residuales según SVGW, EN1717	●	●	●	●	●
Protección IPX 5 contra salpicaduras y chorros de agua	●	●	●	●	●
Patas del equipo regulables en altura	–	–	●	–	●
Zócalo del equipo con junta circundante	●	●	–	●	–
Montaje posible sobre una mesa de 700 mm de profundidad (6-1/1 y 10-1/1)	●	●	–	●	–
Montaje posible sobre 600 mm una mesa de profundidad	●	–	–	–	–
Soporte de pared (XS 6-2/3 y 6-1/1)	●	●	–	●	–
Dispositivo de inmovilización	–	–	●	–	●
Voltajes especiales a petición	○	○	○	○	○
Gas natural o GLP	–	●	●	●	●

* ENERGY STAR está disponible para los sistemas de cocción 6-1/1 y 6-2/1 en versión eléctrica y de gas, además de versión 10-1/1 eléctrica.

● Estándar | ○ Opcional | – No disponible | □ Accesorios

Características del equipamiento iCombi

Higiene, seguridad laboral y ergonomía	iCombi Pro			iCombi Classic	
	XS 6-2/3	6-1/1 10-1/1 6-2/1 10-2/1	20-1/1 20-2/1	6-1/1 10-1/1 6-2/1 10-2/1	20-1/1 20-2/1
Limitador de temperatura de seguridad para generador de vapor y calefactor de aire caliente	●	●	●	●	●
Certificado según normas nacionales e internacionales para el funcionamiento sin supervisión	●	●	●	●	●
Apertura inversa para puerta cámara de cocción	○	○	–	○	–
Tirador de la puerta con giro hacia la derecha/izquierda para operación ergonómica con una sola mano y función de cierre por impulso	●	●	–	●	–
Tirador de la puerta para operación ergonómica con una sola mano, función de cierre por impulso y bloqueo de la puerta	–	–	●	–	●
Máxima altura de carga 1,60 m (con equipo colocado sobre mesa de RATIONAL)	●	●	○	●	○
Kit Combi-Duo – Sistema de cocción apilable (según la variante de montaje con una altura de carga máxima de 1,60 m)	□	□	–	□	–
Cierre de seguridad para la puerta	○	○	○	○	○
drenaje de grasa integrado	–	○	○	○	○
SecurityLine (versión alta seguridad)	–	○	○	○	○
Panel de control cerrable	–	○	○	○	○
Protección abatible del panel de mando	–	○	○	○	○
MarineLine (versión para buques)	○	○	○	○	○
HeavyDutyLine	–	○	○	○	○
MobilityLine – Equipos de suelo móviles con ruedas	–	–	□	–	□
MobilityLine – Equipos de sobremesa móviles sobre UG reforzado	–	□	–	□	–

● Estándar | ○ Opcional | – No disponible | □ Accesorios

iVario 2-XS iVario Pro 2-S, L, XL





iVario 2-XS

Precio	11.980€*
Referencia de artículo	WZ9ENRA.0002030
Capacidad	2 x 13 dm ² , 2 x 17 l
Número de comidas	A partir de 30
Ancho	1100 mm
Profundidad	756 mm
Altura	485 mm
Peso	117 kg
Potencia de conexión	14 kW
Potencia de conexión con la opción Balanced Power	-
Tensión de alimentación	3 NAC 400 V

Equipos básicos y variantes de instalación

Equipo básico (patas de plástico de 90 mm)	11.980€*
Montaje a ras del suelo (patas de plástico de 45 mm y zócalo)	Sin recargo
Mesa con patas	1.833€
Mesa con patas de acero inoxidable	1.907€
Mesa con ruedas móviles	2.143€
Mesa regulable eléctricamente en altura	3.145€
Mesa para el montaje en base con bastidor de montaje	1.982€

Equipo básico	-
Subestructura con patas de plástico ajustables	-
Subestructura con patas de acero inoxidable	-
Subestructura con ruedas móviles	-
Subestructura regulable eléctricamente en altura	-
Subestructura para el montaje en zócalo	-
Paneles para cubrir la subestructura	-
Espacio de almacenamiento para la subestructura	-

Opciones

Cocción con presión	-
iZoneControl	1.023€
Cocción a baja temperatura	795€

Accesorios

Aquí encontrará el accesorio adecuado	Página [54]
---------------------------------------	-------------

Recibirá más información sobre las variantes de montaje, opciones, combinación de opciones y voltajes especiales previa solicitud.

*El precio del sistema de cocción incluye el equipamiento básico de accesorios por valor de 698€ (encontrará detalles sobre el equipamiento en página [54]).

**Sistema de cocción con la opción de subestructura con patas de plástico.

iVario Pro



iVario Pro 2-S

iVario Pro L

iVario Pro XL

17.700€

20.193€**

26.583€**

WY9ENRA.0002039

WX9ENRA.0002131

WW9ENRA.0002137

2 x 19 dm², 2 x 25 l

39 dm², 100 l

59 dm², 150 l

50–100

100–300

100–500

1100 mm

1030 mm

1365 mm

938 mm

894 mm

894 mm

485 mm

1078 mm**

1078 mm**

134 kg

216 kg**

256 kg**

21 kW

27 kW

41 kW

–

21 kW

34 kW

3 NAC 400 V

3 NAC 400 V

3 NAC 400 V

17.700€

–

–

Sin recargo

–

–

2.328€

–

–

2.403€

–

–

2.638€

–

–

3.641€

–

–

2.477€

–

–

–

19.420€

25.810€

–

773€

773€

–

1.057€

1.057€

–

1.227€

1.227€

–

3.397€

3.397€

–

980€

980€

–

397€

453€

–

1.045€

1.352€

2.830€

3.400€

3.870€

•

•

•

•

•

•

Página [56]

Página [58]

Página [58]

Opciones iVario

Cocción con presión

Con la opción de cocción a presión es posible cocinar diferentes alimentos rápido, pero con delicadeza. Se garantiza un nivel de presión homogéneo óptimo, con lo cual se mantiene la estructura celular del alimento. Se trata de un sistema seguro que no precisa mantenimiento. Sobrepresión máxima: 300 mbar.

iVario 2-XS	iVario Pro 2-S	iVario Pro L	iVario Pro XL
–	2.830€	3.400€	3.870€

iZoneControl

División flexible del fondo de la cuba en zonas con distintas temperaturas.

iVario 2-XS	iVario Pro 2-S	iVario Pro L	iVario Pro XL
1.023€	•	•	•

Cocción a baja temperatura

Uso de procesos de cocción inteligentes para la cocción a baja temperatura, confitar y la cocción al vacío.

iVario 2-XS	iVario Pro 2-S	iVario Pro L	iVario Pro XL
795€	•	•	•

Modo de fritura bloqueado

El modo de funcionamiento "Freír" no está disponible. Esta opción se puede utilizar para ahorrar en la instalación de dispositivos de extinción de incendios, necesarios en caso de superar los valores límite.

iVario 2-XS	iVario Pro 2-S	iVario Pro L	iVario Pro XL
Sin recargo	Sin recargo	Sin recargo	Sin recargo

Módulo Wi-Fi

Por medio del módulo Wi-Fi integrado el sistema de cocción se puede conectar a una red Wi-Fi existente, p. ej., para la conexión a ConnectedCooking.

iVario 2-XS	iVario Pro 2-S	iVario Pro L	iVario Pro XL
330€	•	•	•

Puerto Ethernet

Por medio de la interfaz Ethernet integrada el sistema de cocción puede integrarse en una red existente, p. ej., para conectarlo a ConnectedCooking o para descargar datos APPCC.

iVario 2-XS	iVario Pro 2-S	iVario Pro L	iVario Pro XL
147€	147€	147€	147€

Enchufe protegido con dispositivo de corriente residual

Protección del enchufe integrado con dispositivo de corriente residual.

iVario 2-XS	iVario Pro 2-S	iVario Pro L	iVario Pro XL
215€	215€	215€	215€

Preparación de la conexión para un sistema de optimización de energía

Toma para una instalación de optimización de energía (p. ej., Sicotronic, RSW). En este caso, los terminales de conexión están premontados.

iVario 2-XS	iVario Pro 2-S	iVario Pro L	iVario Pro XL
181€	181€	181€	181€

Opciones iVario

Preparación de la conexión SOLAS (Safety of Life at Sea)

El sistema de cocción dispone de un termostato adicional y puede conectarse a un transductor de señales externo de 230 V (máx. 8A, no incluido entre los contenidos suministrados). En este caso, los correspondientes bornes de conexión dentro del equipo están premontados y permiten: visualizar la conexión de tensión del equipo, visualizar el sobrecalentamiento del aceite y poner el equipo fuera de servicio mediante un dispositivo de parada de emergencia (aparato no incluido entre los contenidos suministrados). El equipo lleva integrado un contacto sin potencial, por lo que no es necesario encargarlo aparte. Puede combinarse con la opción «Enchufe protegido con dispositivo de corriente residual».

Nota:

para la instalación de Marine solo se pueden usar las configuraciones siguientes (DNV-GL):

iVario 2-XS e iVario Pro 2-S. Sistema de cocción con patas de plástico de 90 mm, kit de fijación de equipo (60.76.118) y mesa MarineLine (modelo 2-XS: 60.31.701, modelo 2-S: 60.31.702).

iVario Pro L e iVario Pro XL: sistema de cocción con subestructura y patas de acero inoxidable

Las patas de acero inoxidable de las mesas/subestructuras deben fijarse al suelo obligatoriamente mediante atornillado o soldadura.

iVario 2-XS	iVario Pro 2-S	iVario Pro L	iVario Pro XL
192 €	192 €	192 €	192 €

Preparación de la conexión para desconexión remota y salida de la señal

El sistema de cocción puede conectarse a un transductor de señales de 230 V (máx. 8 A, no incluido en el suministro). En este caso, los terminales de conexión correspondientes dentro del equipo están premontados. Esto permite visualizar la conexión de tensión del equipo y el sobrecalentamiento del aceite y poner el equipo fuera de servicio mediante un dispositivo externo de parada de emergencia (aparato no incluido en el suministro). El equipo lleva integrado un contacto sin potencial, por lo que no es necesario encargarlo aparte. Puede combinarse con la opción «Enchufe protegido con dispositivo de corriente residual».

iVario 2-XS	iVario Pro 2-S	iVario Pro L	iVario Pro XL
192 €	192 €	192 €	192 €

Contacto libre de potencial

El sistema de cocción cuenta con un contacto libre de potencial interno, premontado para el registro de informaciones mediante el estado del sistema de cocción.

iVario 2-XS	iVario Pro 2-S	iVario Pro L	iVario Pro XL
147 €	147 €	147 €	147 €

Panel de control cerrable

El panel de control cerrable con llave protege el sistema de cocción frente a un uso no deseado.

iVario 2-XS	iVario Pro 2-S	iVario Pro L	iVario Pro XL
624 €	624 €	624 €	624 €

Toma de agua caliente

Posibilidad de conectar a una toma de agua fría y a una toma de agua caliente. Con el uso de la alimentación de agua caliente, se reducirán los tiempos de calentamiento al cocinar. El tubo de alimentación de agua (1,50 m) se incluye en el suministro.

iVario 2-XS	iVario Pro 2-S	iVario Pro L	iVario Pro XL
–	–	397 €	397 €

Balanced Power

Con esta opción, la potencia de conexión se reduce en comparación con el sistema de cocción estándar para reflejar las condiciones de instalación limitadas. Al mismo tiempo, cambian los tiempos de precalentamiento y cocción.

iVario 2-XS	iVario Pro 2-S	iVario Pro L	iVario Pro XL
–	–	Sin recargo	Sin recargo

● Estándar | ○ Opcional | – No disponible

Variantes de montaje para iVario 2-XS e iVario Pro 2-S

La iVario puede integrarse de forma óptima en casi cualquier cocina. Su concepto modular ofrece numerosas posibilidades para realizar un montaje o instalación óptimo. Totalmente al gusto de su cliente.



Instalación hermética al suelo

Montaje con 45 mm patas de plástico altas y un zócalo.

Opcional	Tipo 2-XS	Sin recargo
Opcional	Tipo 2-S	Sin recargo

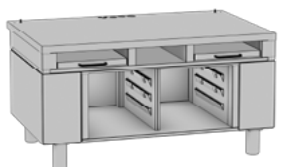

Mesa regulables eléctricamente en altura

Rango de ajuste: + 175 mm / - 25 mm en comparación con la altura estándar. 2 bases extraíbles, 6 pares de 1/1 GN (325 × 530 mm) carriles de soporte. Paneles laterales y tapa cerrada. No se necesita conexión independiente a la corriente; control a través de la pantalla de la iVario. Tubo flexible de desagüe incluido.

60.31.326	Tipo 2-XS, dimensiones An P Al: 1100 713 570-770 mm	3.145 €
60.31.327	Tipo 2-S, dimensiones An P Al: 1100 895 570-770 mm	3.641 €

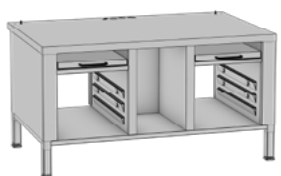

Mesa con patas

2 bases extraíbles, 6 pares de 1/1 GN (325 × 530 mm) carriles de soporte. Paneles laterales y sin panel posterior. 4 patas regulables.

60.31.221	Tipo 2-XS, dimensiones An P Al: 1100 717 595 mm	1.833 €
60.31.319	Tipo 2-S, dimensiones An P Al: 1100 899 595 mm	2.328 €

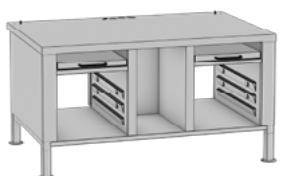

Mesa con patas de acero inoxidable

2 bases extraíbles, 6 pares de 1/1 GN (325 × 530 mm) carriles de soporte. Paneles laterales y sin panel posterior. 4 patas de acero inoxidable con preparación para fijación (no regulables).

60.31.538	Tipo 2-XS, dimensiones An P Al: 1130 717 595 mm	1.907 €
60.31.539	Tipo 2-S, dimensiones An P Al: 1130 899 595 mm	2.403 €

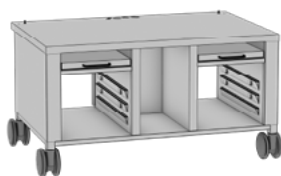

Mesa con ruedas móviles

2 bases extraíbles, 6 pares de 1/1 GN (325 × 530 mm) carriles de soporte. Paneles laterales y sin panel posterior. 4 ruedas móviles con 125 mm de diámetro, de las cuales 2 bloqueables (no regulables).

60.31.317	Tipo 2-XS, dimensiones An P Al: 1145 809 595 mm	2.143 €
60.31.320	Tipo 2-S, dimensiones An P Al: 1145 991 595 mm	2.638 €

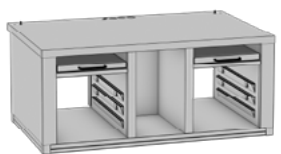

Mesa para el montaje en base con bastidor de montaje

2 bases extraíbles, 6 pares de 1/1 GN (325 × 530 mm) carriles de soporte. Paneles laterales y sin panel posterior, sin patas. Bastidor de montaje para una instalación estable e higiénica sobre en base. Profundidad mínima del zócalo 600 mm para el tipo 2-XS, 650 mm para el tipo 2-S.

60.31.540	Tipo 2-XS, dimensiones An P Al: 1100 717 464 mm	1.982 €
60.31.541	Tipo 2-S, dimensiones An P Al: 1100 899 464 mm	2.477 €

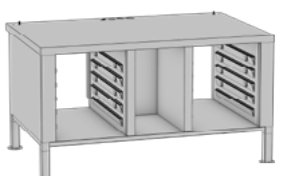

Mesa MarineLine

10 pares de carriles de soporte 1/1 GN (325 × 530 mm) con mecanismo de bloqueo. Paneles laterales y tapa cerrada, sin panel posterior. 4 patas de acero inoxidable con preparación para fijación (no regulables). El sistema de cocción debe fijarse a la mesa con el kit de fijación de equipo 60.76.118.

60.31.701	Tipo 2-XS, dimensiones An P Al: 1100 694 595 mm	2.100 €
60.31.702	Tipo 2-S, dimensiones An P Al: 1100 876 595 mm	2.600 €

Variantes de montaje para iVario Pro L e iVario Pro XL

La iVario puede integrarse de forma óptima en casi cualquier cocina. Su concepto modular ofrece numerosas posibilidades para realizar un montaje o instalación óptimo. Totalmente al gusto de su cliente.

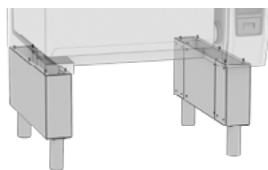

Subestructura regulables eléctricamente en altura

Rango de ajuste: + 175 mm / - 25 mm en comparación con la altura estándar. Montaje con subestructura y patas de altura regulable de forma eléctrica, para instalación como equipo de suelo. No se necesita conexión independiente a la corriente; control a través de la pantalla de la iVario. Tubo flexible de desagüe incluido.

Opcional	Tipo L	3.397 €
Opcional	Tipo XL	3.397 €

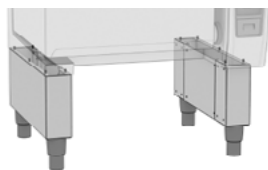

Subestructura con patas de plástico ajustables

Montaje con subestructura y patas de plástico de 150 mm de alto, para instalación como equipo de suelo.

Opcional	Tipo L	773 €
Opcional	Tipo XL	773 €

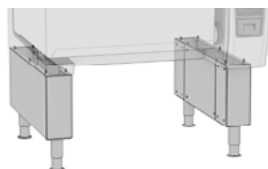

Subestructura con patas de acero inoxidable

Montaje con subestructura y patas de acero inoxidable de 150 mm de alto fijas y regulables, para instalación como equipo de suelo.

Opcional	Tipo L	1.057 €
Opcional	Tipo XL	1.057 €

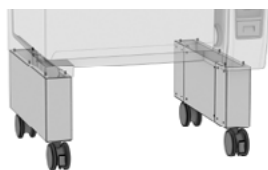

Subestructura con ruedas móviles

Montaje con subestructura y 4 ruedas móviles para montar (no regulables), para instalación como equipo de suelo móvil. 4 ruedas móviles Ø 125 mm, 2 de ellas pueden fijarse. Altura efectiva: 150 mm. No puede combinarse con la opción de cocción a presión.

Opcional	Tipo L	1.227 €
Opcional	Tipo XL	1.227 €

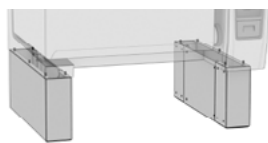

Subestructura para el montaje en zócalo

Montaje con una subestructura sin patas para un montaje higiénico en zócalo sin accesorios de instalación adicionales. Con cuatro patas de nivelación de altura regulable. Profundidad mínima del zócalo 650 mm.

Opcional	Tipo L	980 €
Opcional	Tipo XL	980 €

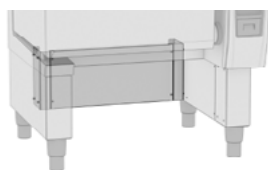

Paneles para cubrir la subestructura

El revestimiento posterior cierra la zona entre las partes laterales y, con ello, cubre las conexiones. Puede combinarse con todas las variantes de mesa. No compatible con el «espacio de almacenamiento para la subestructura».

Opcional	Tipo L	397 €
Opcional	Tipo XL	453 €



Espacio de almacenamiento para la subestructura

El espacio de almacenamiento en la subestructura ofrece carriles de soporte para almacenar los contenedores GN y los accesorios. Cerrado por la parte trasera. Puede combinarse con todas las variantes de mesa. No compatible con los «paneles para cubrir la subestructura».

Opcional	Tipo L	1.045 €
Opcional	Tipo XL	1.352 €



Kit de suspensión mural

Para un montaje en pared del equipo básico (sin subestructura) a fin de facilitar la limpieza bajo el sistema de cocción.

60.75.993	Tipo L	2.185 €
60.75.934	Tipo XL	2.309 €

Accesorios tipo 2-XS

Equipamiento básico de accesorios tipo 2-XS (incluido en el suministro de iVario 2-XS)

Se compone de:

2 × 60.74.791	Brazo para elevación y descenso automáticos, tipo 2-XS	1 × 60.74.970	Cesta de cocción, tipo 2-XS
1 × 60.75.019	Cesta para freír, tipo 2-XS	1 × 60.74.666	Escurreidor, tipo 2-XS
1 × 60.73.927	Estropajo de limpieza		

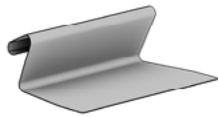

Espátula

Para girar y sacar los productos con facilidad y de forma ergonómica de la iVario.

60.71.643	Espátula 25, ampliado 250 mm	59€
60.77.042	Espátula 33, ampliado 330 mm	93€

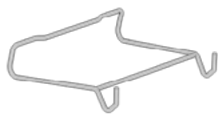

Brazo para elevación y descenso automáticos

Para colgar cestas con AutoLift.

60.74.791	Tipo 2-XS	73€
-----------	-----------	-----



Cesta de cocción

Para hervir en cestas con AutoLift. Solo en relación con brazo para elevación y descenso automáticos.

60.74.970	Tipo 2-XS	222€
-----------	-----------	------



Cesta para freír

Para freír en cestas con AutoLift. Solo en relación con brazo para elevación y descenso automáticos.

60.75.019	Tipo 2-XS	222€
-----------	-----------	------

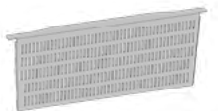

Escurreidor

Para escurrir fácilmente los productos cocidos a granel.

60.74.666	Tipo 2-XS, 2-S	85€
-----------	----------------	-----



Parrilla de fondo de cuba

Evitar el contacto directo entre el alimento y el fondo de la cuba durante la cocción a baja temperatura.

60.74.832	Tipo 2-XS	73€
-----------	-----------	-----



Kit de 4 cestas individuales

60.75.300	Kit de 4 cestas individuales 1/6 GN (176 × 162 mm) perforadas + bastidor de cesta individual	382€
60.75.978	Kit de 4 cestas individuales 1/6 GN (176 × 162 mm) no perforadas con tapa + bastidor de cesta individual	382€
60.75.979	Kit de 4 cestas individuales 1/6 GN (176 × 162 mm) para freír + bastidor de cesta individual	382€
60.76.407	Kit de 4 cestas individuales 1/6 GN (176 × 162 mm) perforadas, 4 cestas individuales 1/6 GN (176 × 162 mm) no perforadas con tapa + 2 bastidores de cesta individual tipo 2-XS. Ahorre hasta el 10 % en comparación con el precio de compra.	688€



Kit de 2 cestas individuales

60.75.302	Kit de 2 cestas individuales 1/6 GN (176 × 162 mm) no perforadas con tapa	159€
60.75.303	Kit de 2 cestas individuales 1/6 GN (176 × 162 mm) perforadas	159€
60.75.982	Kit de 2 cestas individuales 1/6 GN (176 × 162 mm) para freír	159€
60.75.311	Kit de 2 tapas para cesta individual 1/6 GN (176 × 162 mm)	48€

Accesorios tipo 2-XS



VarioMobil 1/1 GN

Para vaciar los alimentos de forma segura y sin esfuerzos, así como para transportar en 1/1 GN (325 × 530 mm) recipientes (recipientes GN no incluidos en el suministro). Regulable en 4 alturas.

60.73.349	Tipo 2-XS, 2-S	850€
-----------	----------------	------

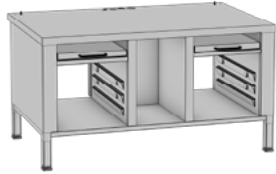

Mesa

2 bases extraíbles, 6 pares de 1/1 GN (325 × 530 mm) carriles de soporte. Paneles laterales y sin panel posterior.

60.31.221	Con patas, dimensiones An P Al: 1100 717 595 mm	1.833€
60.31.538	Con patas de acero inoxidable, dimensiones An P Al: 1130 717 595 mm	1.907€
60.31.317	Con ruedas móviles, dimensiones An P Al: 1145 809 595 mm	2.143€
60.31.540	Para el montaje en base con bastidor de montaje, dimensiones An P Al: 1100 717 464 mm	1.982€
60.31.326	Con regulable eléctricamente en altura (parte posterior cerrada), dimensiones An P Al: 1100 713 570-770 mm	3.145€

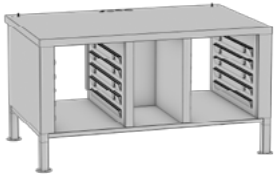

Mesa MarineLine

10 pares de carriles de soporte 1/1 GN (325 × 530 mm) con mecanismo de bloqueo. Paneles laterales y tapa cerrada, sin panel posterior. 4 patas de acero inoxidable con preparación para fijación (no regulables). El sistema de cocción debe fijarse a la mesa con el kit de fijación de equipo 60.76.118.

60.31.701	Tipo 2-XS, dimensiones An P Al: 1100 694 595 mm	2.100€
-----------	---	--------

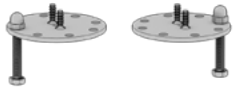

Kit de fijación de equipo

Para la fijación del sistema de cocción en una encimera o mesa existente (2 piezas).

60.76.118	Tipo 2-XS, 2-S	98€
-----------	----------------	-----



Kit de conexión de equipo a aguas residuales

Se compone de tuberías de desagüe DN 40.

87.00.745	Tipo 2-XS, 2-S	137€
-----------	----------------	------



USB de RATIONAL

42.00.162	Memoria USB 3.0 para programas de cocción y datos APPCC	16€
-----------	---	-----

Accesorios tipo 2-S

Equipamiento básico accesorios

Ahorre hasta el 10 % en comparación con el precio de compra.

87.00.742	Tipo 2-S	989€
-----------	----------	------

Se compone de:

1 × 60.71.643	Espátula 25	2 × 60.75.359	Brazo para elevación y descenso automáticos, tipo 2-S
1 × 60.74.986	Cesta de cocción, tipo 2-S	1 × 60.75.330	Cesta para freír, tipo 2-S
1 × 60.74.666	Escurreidor, tipo 2-S	2 × 60.74.663	Parrilla de fondo de cuba, tipo 2-S
1 × 60.73.927	Estropajo de limpieza		

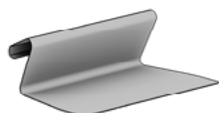

Espátula

Para girar y sacar los productos con facilidad y de forma ergonómica de la iVario.

60.71.643	Espátula 25, ampliado 250 mm	59€
60.77.042	Espátula 33, ampliado 330 mm	93€



Pala

Para vaciar y formar porciones de grandes cantidades de alimentos de forma segura y sencilla.

60.73.348	Pala no perforada	134€
60.73.586	Pala perforada	134€



Brazo para elevación y descenso automáticos

Para colgar cestas con AutoLift.

60.75.359	Tipo 2-S	73€
-----------	----------	-----



Cesta de cocción

Para hervir en cestas con AutoLift. Solo en relación con brazo para elevación y descenso automáticos.

60.74.986	Tipo 2-S	296€
-----------	----------	------



Cesta para freír

Para freír en cestas con AutoLift. Solo en relación con brazo para elevación y descenso automáticos.

60.75.330	Tipo 2-S	296€
-----------	----------	------



Escurreidor

Para escurrir fácilmente los productos cocidos a granel.

60.74.666	Tipo 2-XS, 2-S	85€
-----------	----------------	-----



Parrilla de fondo de cuba

Evitar el contacto directo entre el alimento y el fondo de la cuba durante la cocción a baja temperatura.

60.74.663	Tipo 2-S, L, XL	97€
-----------	-----------------	-----



Kit de 6 cestas individuales

60.75.305	Kit de 6 cestas individuales 1/6 GN (176 × 162 mm) perforadas + bastidor de cesta individual	569€
60.75.306	Kit de 6 cestas individuales 1/6 GN (176 × 162 mm) no perforadas con tapa + bastidor de cesta individual	569€
60.75.307	Kit de 6 cestas individuales 1/6 GN (176 × 162 mm) para freír + bastidor de cesta individual	569€
60.76.408	Kit de 6 cestas individuales 1/6 GN (176 × 162 mm) perforadas, 6 cestas individuales 1/6 GN (176 × 162 mm) no perforadas con tapa + 2 bastidores de cesta individual tipo 2-S.	1.024€

Ahorre hasta el 10 % en comparación con el precio de compra.

Accesorios tipo 2-S



Kit de 2 cestas individuales

60.75.302	Kit de 2 cestas individuales 1/6 GN (176 × 162 mm) no perforadas con tapa	159€
60.75.303	Kit de 2 cestas individuales 1/6 GN (176 × 162 mm) perforadas	159€
60.75.982	Kit de 2 cestas individuales 1/6 GN (176 × 162 mm) para freír	159€
60.75.311	Kit de 2 tapas para cesta individual 1/6 GN (176 × 162 mm)	48€



VarioMobil 1/1 GN

Para vaciar los alimentos de forma segura y sin esfuerzos, así como para transportar en 1/1 GN (325 × 530 mm) recipientes (recipientes GN no incluidos en el suministro). Regulable en 4 alturas.

60.73.349	Tipo 2-XS, 2-S	850€
-----------	----------------	------



Carro de almacenamiento

Para guardar, transportar y escurrir cestas. Capacidad: máx. 16 recipientes GN o máx. tres cestas (tipo 2-S o L, XL) 1 brazo para elevación y descenso automáticos (tipo L o XL).

60.73.612	Tipo 2-S, L, XL	1.212€
-----------	-----------------	--------

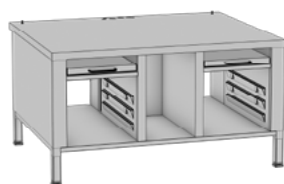

Mesa

2 bases extraíbles, 6 pares de 1/1 GN (325 × 530 mm) carriles de soporte. Paneles laterales y sin panel posterior.

60.31.319	Con patas, dimensiones An P Al: 1100 899 595 mm	2.328€
60.31.539	Con patas de acero inoxidable, dimensiones An P Al: 1130 899 595 mm	2.403€
60.31.320	Con ruedas móviles, dimensiones An P Al: 1145 991 595 mm	2.638€
60.31.541	Para el montaje en base con bastidor de montaje, dimensiones An P Al: 1100 899 464 mm	2.477€
60.31.327	Con regulable eléctricamente en altura (parte posterior cerrada), dimensiones An P Al: 1100 895 570-770 mm	3.641€

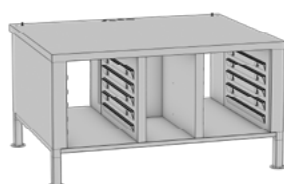

Mesa MarineLine

10 pares de carriles de soporte 1/1 GN (325 × 530 mm) con mecanismo de bloqueo. Paneles laterales y tapa cerrada, sin panel posterior. 4 patas de acero inoxidable con preparación para fijación (no regulables). El sistema de cocción debe fijarse a la mesa con el kit de fijación de equipo 60.76.118.

60.31.702	Tipo 2-S, dimensiones An P Al: 1100 876 595 mm	2.600€
-----------	--	--------



Kit de fijación de equipo

Para la fijación del sistema de cocción en una encimera o mesa existente (2 piezas).

60.76.118	Tipo 2-XS, 2-S	98€
-----------	----------------	-----



Kit de conexión de equipo a aguas residuales

Se compone de tuberías de desagüe DN 40.

87.00.745	Tipo 2-XS, 2-S	137€
-----------	----------------	------



USB de RATIONAL

42.00.162	Memoria USB 3.0 para programas de cocción y datos APPCC	16€
-----------	---	-----

Accesorios tipo L, XL

Equipamiento básico accesorios

Ahorre hasta el 10 % en comparación con el precio de compra.

87.00.743	Tipo L	1.144 €
87.00.744	Tipo XL	1.531 €

Tipo L se compone de:

1 × 60.77.042	Espátula 33	1 × 60.75.909	Brazo para elevación y descenso automáticos, tipo L
2 × 60.74.983	Cesta de cocción, tipo L, XL	1 × 60.75.975	Escurreidor, tipo L
2 × 60.74.663	Parrilla de fondo de cuba, tipo L, XL	1 × 60.73.927	Estropajo de limpieza

Tipo XL se compone de:

1 × 60.77.042	Espátula 33	1 × 60.75.129	Brazo para elevación y descenso automáticos, tipo XL
3 × 60.74.983	Cesta de cocción, tipo L, XL	1 × 60.74.908	Escurreidor, tipo XL
3 × 60.74.663	Parrilla de fondo de cuba, tipo L, XL	1 × 60.73.927	Estropajo de limpieza

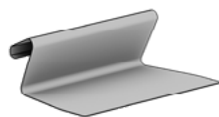

Espátula

Para girar y sacar los productos con facilidad y de forma ergonómica de la iVario.

60.71.643	Espátula 25, ampliado 250 mm	59 €
60.77.042	Espátula 33, ampliado 330 mm	93 €



Remo

Para incorporar y remover alimentos hasta una temperatura de 120 °C.

60.72.131	Tipo L, XL	184 €
-----------	------------	-------



Pala

Para vaciar y formar porciones de grandes cantidades de alimentos de forma segura y sencilla.

60.73.348	Pala no perforada	134 €
60.73.586	Pala perforada	134 €

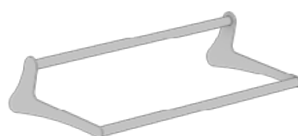

Brazo para elevación y descenso automáticos

Para colgar cestas con AutoLift.

60.75.909	Tipo L	222 €
60.75.129	Tipo XL	259 €



Cesta de cocción

Para hervir en cestas con AutoLift. Solo en relación con brazo para elevación y descenso automáticos.

60.74.983	Tipo L, XL	296 €
-----------	------------	-------



Cesta para freír

Para freír en cestas con AutoLift. Solo en relación con brazo para elevación y descenso automáticos.

60.75.391	Tipo L, XL	296 €
-----------	------------	-------



Escurreidor

Para escurrir fácilmente los productos cocidos a granel.

60.75.975	Tipo L	147 €
60.74.908	Tipo XL	147 €

Accesorios tipo L, XL



Parrilla de fondo de cuba

Evitar el contacto directo entre el alimento y el fondo de la cuba durante la cocción a baja temperatura.
Recomendación: Tipo L: 2 unidades, tipo XL: 3 unidades.

60.74.663	Tipo 2-S, L, XL	97 €
-----------	-----------------	------



VarioMobil 2/1 GN

Para vaciar los alimentos de forma segura y sin esfuerzos, así como para transportar en 2/1 GN (650 x 530 mm) o 1/1 GN (325 x 530 mm) recipientes (recipientes GN no incluidos suministro). Regulable en altura (2 posiciones).

60.70.107	Tipo L, XL	1.650 €
-----------	------------	---------



Carro de almacenamiento

Para guardar, transportar y escurrir cestas. Capacidad: máx. 16 recipientes GN o máx. tres cestas (tipo 2-S o L, XL) 1 brazo para elevación y descenso automáticos (tipo L o XL).

60.73.612	Tipo 2-S, L, XL	1.212 €
-----------	-----------------	---------



Carro de aceite

Para el llenado de la cuba de cocción y para el almacenaje y filtrado del aceite. Con función de precalentamiento para derretir la grasa o calentar el aceite frío. Se puede evacuar el aceite.

60.74.941	Tipo L, XL	4.990 €
-----------	------------	---------



Kit de fijación al suelo

Para la colocación segura del sistema de cocción (variante de instalación con patas de plástico) al suelo (2 piezas).

60.72.905	Tipo L, XL	122 €
-----------	------------	-------



Kit de suspensión mural

Montaje del equipo básico en pared (sin subestructura) para facilitar la limpieza bajo el sistema de cocción. Con conducción de vapor integrada.

60.75.993	Tipo L	2.185 €
-----------	--------	---------

60.75.934	Tipo XL	2.309 €
-----------	---------	---------



Kit de conexión de equipo a aguas residuales

Se compone de tuberías de desagüe DN 50.

87.00.746	Tipo L, XL	137 €
-----------	------------	-------



USB de RATIONAL

42.00.162	Memoria USB 3.0 para programas de cocción y datos APPCC	16 €
-----------	---	------

Productos de limpieza del iVario



Brazo limpiador, incluidos 4 discos limpiadores

Se compone de 1 brazo limpiador, 2 discos limpiadores duros, 2 discos limpiadores suaves.

60.73.925	Tipo 2-XS, 2-S, L, XL	146€
-----------	-----------------------	------



Kit con 2 discos limpiadores duros

Para la limpieza de la suciedad incrustada en combinación con el brazo limpiador.

60.73.922	Kit con 2 discos limpiadores duros	55€
-----------	------------------------------------	-----



Kit con 2 discos limpiadores suaves

Para la limpieza de la suciedad en combinación con el brazo limpiador.

60.73.923	Kit con 2 discos limpiadores suaves	55€
-----------	-------------------------------------	-----



Kit con 6 esponjas limpiadoras

Para limpiar la cuba con rapidez y eficacia.

60.73.924	Kit con 6 esponjas limpiadoras	118€
-----------	--------------------------------	------



Detergente para parrilla

Para un refuerzo perfecto de la higiene y la limpieza.

9006.0153	Detergente líquido 10 l	70€
-----------	-------------------------	-----



Kit de limpieza

Se compone de 10 l detergente para parrilla, 1 brazo limpiador, 2 discos de limpieza duros, 2 discos de limpieza suaves, 1 estropajo de limpieza.

60.73.920	Kit de limpieza	179€
-----------	-----------------	------

Opciones de adaptación para iVario 2-XS e iVario Pro 2-S*

Opciones de adaptación

Art. N.º	Denominación	Modelo de equipo	Nota
60.31.432	Kit de 4 patas de plástico ajustables para mesa	2-XS, 2-S	
60.31.524	Kit de 4 patas de acero inoxidable para mesa	2-XS, 2-S	
60.31.433	Kit de 4 ruedas móviles para mesa	2-XS, 2-S	
60.77.055	Kit de bastidor de montaje en base para mesa	2-XS	
60.77.048	Kit de bastidor de montaje en base para mesa	2-S	
87.00.749	Kit de ajuste de altura de la conexión de equipo (tubo de desagüe flexible DN50-DN50/40)	2-XS, 2-S	Ya está disponible en la mesa regulable eléctricamente en altura. El kit de conexión de equipo a aguas residuales también es necesario.
-	Mesa con ajuste de altura eléctrico	2-XS, 2-S	No es posible como adaptación.

Kits de adaptación (se pueden pedir únicamente como piezas de mantenimiento)

Art. N.º	Denominación	Modelo de equipo	Nota
87.01.813S	Kit de adaptación con conexión para optimización de energía	2-XS, 2-S	
87.01.643S	Kit de adaptación para Ethernet	2-XS, 2-S	
87.01.821S	Kit de adaptación para contacto libre de potencial	2-XS, 2-S	
87.01.833S	Kit de adaptación para retirar la ducha de mano	2-XS, 2-S	
87.01.848S	Kit de adaptación con panel de control cerrable con llave RATIONAL	2-S	
87.01.849S	Kit de adaptación con panel de control cerrable con llave RATIONAL	2-XS	
87.01.819S	Kit de adaptación con dispositivo de corriente residual	2-XS, 2-S	Solo para tensión 3 NAC 400V 50/60Hz
Cambio de patas de 90 mm a 45 mm:			
87.01.835S	Base de espuma	2-XS	Las patas de 90 mm pueden cambiarse a patas de 45 mm.
87.01.834S	Base de espuma	2-S	Las patas de 90 mm pueden cambiarse a patas de 45 mm.
Cambio de patas de 45 mm a 90 mm:			
87.01.591S	Pata delantera 90 mm	2-XS, 2-S	
87.01.590S	Pata trasera 90 mm	2-XS, 2-S	Se necesitan dos unidades para el cambio.

Opciones activables**

Art. N.º	Denominación	Modelo de equipo	Nota
80.00.490	Cocción a baja temperatura	2-XS	Es necesario actualizar a la versión del software LMX-2.3.16 o superior.
80.00.491	Módulo WiFi	2-XS	Es necesario actualizar a la versión del software LMX-2.3.16 o superior.
80.00.492	iZoneControl	2-XS	Es necesario actualizar a la versión del software LMX-2.3.16 o superior.

*Precios a petición expresa

**Por favor, para pedidos contacte con el servicio RATIONAL de atención al cliente.

Opciones de adaptación para iVario Pro L y XL*

Opciones de adaptación

Art. N.º	Denominación	Modelo de equipo	Nota
60.74.364	Kit de 4 patas de plástico ajustables	L, XL	Para subestructura.
60.74.500	Kit de 4 patas de acero inoxidable ajustables	L, XL	Para subestructura.
60.71.267	Kit de 4 ruedas móviles	L, XL	Para subestructura. No homologado para equipos con función de cocción a presión.
60.76.119	Kit de montaje en base	L, XL	Para subestructura.
60.74.865	Espacio de almacenamiento para la subestructura	L	
60.74.696	Espacio de almacenamiento para la subestructura	XL	
60.76.306	Paneles para cubrir la subestructura	L	
60.76.305	Paneles para cubrir la subestructura	XL	
87.00.749	Kit de ajuste de altura de la conexión de equipo (tubo de desagüe flexible DN50-DN50/40)	L, XL	Ya está disponible en los equipos con subestructura regulable eléctricamente en altura. El kit de conexión de equipo a aguas residuales también es necesario.
80.00.615	Balanced Power ON, modelos L, XL	L, XL	Solo para tensión 3 NAC 400V 50/60Hz
80.00.616	Balanced Power OFF, modelos L, XL	L, XL	Solo para tensión 3 NAC 400V 50/60Hz
-	Subestructura de altura regulable mediante sistema eléctrico	L, XL	No es posible como adaptación.

Kits de adaptación (se pueden pedir únicamente como piezas de mantenimiento)

Art. N.º	Denominación	Modelo de equipo	Nota
87.01.793S	Kit de adaptación para subestructura	L, XL	Incluye una subestructura completa para iVario Pro L y XL. Las patas deben pedirse por separado.
87.01.814S	Kit de adaptación con conexión para optimización de energía	L, XL	
87.01.792S	Kit de adaptación para Ethernet	L, XL	
87.01.821S	Kit de adaptación para contacto libre de potencial	L, XL	
87.01.833S	Kit de adaptación para retirar la ducha de mano	L, XL	
87.01.848S	Kit de adaptación con panel de control cerrable con llave RATIONAL	L, XL	
87.01.820S	Kit de adaptación con dispositivo de corriente residual	L, XL	Solo para tensión 3 NAC 400V 50/60Hz
87.01.901S	Kit de adaptación con opción de agua caliente	L, XL	

*Precios a petición expresa

Características del equipamiento iVario

Funciones	iVario Pro			
	2-XS	2-S	L	XL
iCookingSuite, asistente de cocina inteligente con 6 modos de funcionamiento: Carne, Pescado, Verduras y guarniciones, Platos con huevos, Platos con leche y platos dulces, sopas y salsas o 5 procedimientos de cocción: cocer, sofreír, freír, estofar y finishing para introducir de forma sencilla el resultado deseado con el ajuste automático del proceso de cocción ideal	●	●	●	●
Configuración predeterminada específica del país de los parámetros de cocción, independientemente del idioma seleccionado, es posible seleccionar una cocina del país adicional	●	●	●	●
Cocción a baja temperatura (también durante la noche), confitar, cocción al vacío	○	●	●	●
iZoneControl – División flexible del fondo de la cuba en zonas con distintas temperaturas	○	●	●	●
Modo manual: cocción mediante regulación libre de la temperatura del líquido, la temperatura del fondo de la cuba o la temperatura del aceite. Rango de temperatura: de 30 °C–250 °C	●	●	●	●
Gestión integrada de la energía iVarioBoost	●	●	●	●
Creación de perfiles MyDisplay específicos del usuario para una configuración individual de los equipos y el manejo, p. ej., la pantalla de inicio individual	●	●	●	●
1.200 programas hasta con 12 pasos que pueden programarse y designarse libremente	●	●	●	●
Dos cubas independientes de la cuba en funcionamiento	●	●	-	-
Dispositivo de elevación y descenso AutoLift para cocción en cestas	●	●	●	●
Detección del medio de cocción en la cuba: así, el aceite no podrá quemarse	●	●	●	●
Cocción Delta T para la cocción delicada de piezas de carne grandes	●	●	●	●
Cocción delicada para productos delicados	●	●	●	●
Entrada de agua, relleno de la cuba automático y por litros	●	●	●	●
Función de cocción a presión para tiempos de cocción más cortos y mayor productividad	-	○	○	○
Manejo				
Pantalla TFT a color de 10,1 pulgadas con pantalla táctil de cristal, con símbolos explicativos para un manejo sencillo e intuitivo	●	●	●	●
Rosca central de ajuste con función "Push" para confirmar las entradas	●	●	●	●
Instrucciones disponibles en más de 40 idiomas	●	●	●	●
Lista de los favoritos Top 10 entre los procesos de cocción más utilizados de iCookingSuite y los programas manuales, fácil de encontrar bajo la estrella de favoritos en la pantalla de inicio	●	●	●	●
Visualización digital de los valores de temperatura	●	●	●	●
Visualización de valores efectivos y valores teóricos	●	●	●	●
Reloj programador digital de 0-24 horas con posición permanente y posibilidad de configurar el formato hora/ minutos o minutos/segundos.	●	●	●	●
Posibilidad de configurar el tono de la señal acústica y el contraste de pantalla	●	●	●	●
Función de búsqueda y ayuda amplia y sensible al contexto	●	●	●	●
Manual de instrucciones electrónico con consejos prácticos y variedad de ejemplos de aplicación que se inician directamente como proceso de cocción desde el manual	●	●	●	●
Supervisión del equipo desde el ordenador, smartphone o tablet mediante ConnectedCooking	●	●	●	●

● Estándar | ○ Opcional | – No disponible

Características del equipamiento iVario

Características del equipamiento	iVario	iVario Pro		
	2-XS	2-S	L	XL
Sistema de calentamiento iVarioBoost	●	●	●	●
Fondo de la cuba de rápida reacción, alto rendimiento y resistente a los arañazos	●	●	●	●
Sonda térmica con 6 puntos de medición (1 sensor por cuba)	●	●	●	●
Vaciado del agua de cocción o de lavado directamente del desagüe integrado en la cuba	●	●	●	●
Ducha de mano integrada y de manejo ergonómico con dispositivo recogedor automático, presión de salida intercambiable (puntos y chorro de ducha) y función de bloqueo de agua integrada	●	●	●	●
Enchufe integrado, 1 NAC 230 V	●	●	●	●
Posibilidad de seleccionar entre °C o °F	●	●	●	●
Soporte magnético para la sonda térmica	●	●	●	●
La cuba se vuelca con un cilindro eléctrico	●	●	●	●
La tapa se abre y se cierra mediante un cilindro electrónico	-	-	●	●
Tapa con entrada de agua integrada	●	●	●	●
ServiceDiagnose-System (SDS) con visualización automática de los mensajes de servicio	●	●	●	●
Toma de agua fría (incl. manguera de alimentación de agua 1,50 m)	●	●	●	●
Posibilidad de conexión a sistema de optimización de energía (solo para tensiones 3 NCA 400 V y 3 NCA 415 V)	○	○	○	○
Toma para indicador de operaciones / contactos sin potencial, p. ej., para transductores de señales	○	○	○	○
Salida de emisión SOLAS (Safety of Life at Sea)	○	○	○	○
Preparación de la conexión para desconexión remota y salida de la señal	○	○	○	○
Toma de agua caliente (incl. manguera de alimentación de agua 1,50 m)	-	-	○	○
Puerto Wi-Fi integrado, p. ej., para la conexión a ConnectedCooking	○	●	●	●
Balanced Power	-	-	○	○
Voltajes especiales a petición (p. ej., 3 CA 230 V, 3 CA 400 V, 3 CA 440 V)	○	○	○	○
Material interior y exterior de acero inoxidable	●	●	●	●
Instalación				
Patas de plástico con 90 mm altura	●	●	-	-
Montaje a ras del suelo (patas de plástico 45 mm y zócalo)	○	○	-	-
Mesa con patas	○	○	-	-
Mesa con patas de acero inoxidable	○	○	-	-
Mesa con ruedas móviles	○	○	-	-
Mesa regulable eléctricamente en altura	○	○	-	-
Mesa para el montaje en base con bastidor de montaje	○	○	-	-
Mesa MarineLine	○	○	-	-
Subestructura con patas de plástico ajustables	-	-	○	○
Subestructura con patas de acero inoxidable	-	-	○	○
Subestructura con ruedas móviles	-	-	○	○
Subestructura regulable eléctricamente en altura	-	-	○	○
Subestructura para el montaje en zócalo	-	-	○	○
Paneles para cubrir la subestructura	-	-	○	○
Espacio de almacenamiento para la subestructura	-	-	○	○
Suspensión mural	-	-	○	○

● Estándar | ○ Opcional | - No disponible

Características del equipamiento iVario

	iVario		iVario Pro	
	2-XS	2-S	L	XL
Higiene, seguridad laboral y ergonomía				
Visualización de mensajes de servicio y advertencias, p. ej. aceite caliente al freír	●	●	●	●
Modo de fritura bloqueado	○	○	○	○
Panel de control cerrable	○	○	○	○
Enchufe integrado protegido con dispositivo de corriente residual, 1 NAC 230 V	○	○	○	○
Puerto Ethernet, p. ej., para conexión a ConnectedCooking	○	○	○	○
Interfaz USB para la descarga de datos APPCC y servicio, así como para descargar programas de cocción a un USB de RATIONAL y para actualizar fácilmente el software del equipo	●	●	●	●
Limitador de temperatura de seguridad	●	●	●	●
Espacio técnico accesible desde la parte delantera	●	●	●	●
Cuba de cocción higiénica, sin juntas con esquinas redondeadas	●	●	●	●
Símbolo de homologación				
Declaración de conformidad: CE	●	●	●	●
Seguridad eléctrica: SEMKO Intertek, ETL Safety, INMETRO, NOM	●	●	●	●
Seguridad operacional: GS, EAC, Watermark, IRAM, UA TR	●	●	●	●
Seguridad higiénica: NSF, HCV-EU	●	●	●	●
Protección del agua potable: SVGW, TZW, KUK WATER REG4	●	●	●	●
Protección IPX 5 contra salpicaduras y chorros de agua	●	●	●	●
Instalación en barcos: DNV-GL	●	●	●	●

● Estándar | ○ Opcional | – No disponible

Símbolo de homologación para iVario

Los sellos de calidad siguientes confirman que nuestros sistemas de cocción cumplen las directrices y estándares establecidos de los organismos independientes de evaluación y certificación. De esta manera, verá de un vistazo que se cumplen los aspectos relevantes en materia de seguridad a escala nacional e internacional, el valor que le damos a la excelencia en la calidad del producto y el cumplimiento demostrable. También encontrará más información en rational-online.com.



La conformidad CE define los requisitos de calidad fundamentales de los productos que se ponen en circulación en el mercado europeo.



El distintivo GS está reconocido en Europa como símbolo de seguridad. El distintivo GS garantiza al usuario final que el producto ha sido sometido a una inspección de seguridad por un tercero independiente autorizado (Intertek).



La NSF garantiza el cumplimiento internacional de las normas de higiene NSF/ANSI en el lanzamiento al mercado de nuevos equipos.



ETL Safety es un distintivo de seguridad para el mercado norteamericano. Indica que los productos han sido sometidos a pruebas por un laboratorio acreditado de un tercero y que cumplen con las normas de seguridad y los requisitos mínimos vigentes para la comercialización en América del Norte.



Este certificado define los requisitos de los equipos en los sectores del gas y el agua con respecto a la calidad, la seguridad y las características de uso para el mercado suizo.



La EAC establece los requisitos más importantes para los equipos conforme a los requisitos de calidad y seguridad euroasiáticos.



Watermark certifica los equipos para el mercado australiano con el fin de asegurarse de que son adecuados para su uso y cuentan con la autorización a tal efecto.



INMETRO se refiere a todos los equipos o componentes eléctricos con una potencia de conexión inferior a 20 kW en Brasil.



IRAM especifica las disposiciones relativas a la autorización para el mercado argentino, centrándose en la electrónica, el gas, la mecánica, la higiene, la seguridad y los alimentos.



La DNV GL es una sociedad de clasificación internacional que certifica los modelos para embarcaciones de los equipos.



La Norm Oficial Mexican Standard (NOM) designa a una serie de normas y reglamentos vinculantes oficiales para diferentes actividades en México.



La UA TR establece los requisitos más importantes para los equipos conforme a los requisitos de calidad y seguridad ucranianos.



TZW: ofrece ensayos de aptitud sanitaria con especial atención a la potabilidad para todas las áreas del sector del agua nacional e internacional.



Como proveedor mundial de sistemas de cocción profesionales, RATIONAL ha homologado sus productos para que sean compatibles con conectividad Wifi, en la medida en que esté permitido. No dude en contactar con nosotros si desea más información.



La Regulatory Compliance Mark (RCM) es una marca de las autoridades australianas de regulación en materia de electricidad y de la Australian Communications Media Authority (ACMA, autoridad de medios de comunicación de Australia) que indica la conformidad con la normativa australiana sobre productos eléctricos.



KUK WATER REG4 es la marca de certificación de KIWA para el mercado del Reino Unido. Desde 1999, esta certificación permite demostrar que los productos y materiales sanitarios cumplen con la normativa en materia de abastecimiento de agua (instalaciones hidráulicas).



El NSF-HCV certifica la seguridad higiénica de los equipos destinados a la elaboración de alimentos en Europa.

ConnectedCooking



ConnectedCooking es una solución de trabajo en red basada en la nube, una aplicación para dispositivos móviles que da acceso a la documentación automática de datos APPCC, ayuda a la creación y administración de programas de cocción y pone a disposición actualizaciones automáticas de software. ConnectedCooking responde al lema: «Comodidad. Seguridad. Inspiración», y ofrece posibilidades de aplicación absolutamente novedosas y cómodas. Puesto que se trata de una plataforma en la nube, todas las funciones pueden utilizarse directamente. La aplicación ConnectedCooking se encuentra disponible para iPhone, iPad y smartphones y tablets Android en las correspondientes App Stores.

Registro en: ConnectedCooking.com

Adaptador WiFi

Adaptador Wifi con entrada de cable, tiras de fijación, paño de limpieza, imán y limitador de corriente. Apto para SelfCookingCenter desde 09/2011, VarioCookingCenter, iCombi (salvo el tipo XS 6-2/3) y iVario. El adaptador Wifi permite la conexión de sistemas de cocción RATIONAL con conexión Ethernet a un punto de acceso Wifi; como alternativa, puede utilizarse como punto de acceso Wifi adicional para ampliar el rango de alcance para la conexión inalámbrica de hasta cinco sistemas de cocción adicionales.

60.76.714	Adaptador WiFi con cable corto para equipos de sobremesa.	321 €
60.76.603	Adaptador Wifi con cable largo para equipos de suelo.	321 €

Interfaces de comunicación

REST API

Con la ayuda de la API REST podrá transferir los datos APPCC de ConnectedCooking a sistemas de terceros. Para ello, es necesario registrar los sistemas de cocción en ConnectedCooking. La API REST (también denominada API RESTful) es una API (interfaz de programación de aplicaciones) o una API web que está sujeta a las limitaciones de la arquitectura REST y permite la interacción con los servicios web RESTful.

ConnectedCooking	API REST	gratuito
------------------	----------	----------

OPC UA

La interfaz de comunicación OPC UA conforme a la norma DIN 18898 permite la conexión en red segura y versátil de los sistemas de cocción RATIONAL en una red existente. La opción OPC UA a través de la nube está disponible para iCombi Pro, iVario, SelfCookingCenter y VarioCookingCenter. Para ello, es necesario registrar los sistemas de cocción en ConnectedCooking.

ConnectedCooking	OPC UA a través de la nube	gratuito
------------------	----------------------------	----------

RATIONAL

iCombi Pro



RATIONAL



496



BRANCH OFFICES

DELEGACIONES

**Un gran proyecto
se basa en la confianza.**

*A big project
is based on trust.*

Delegaciones en España

Branch offices

ASTÚRIAS

Adolfo Muñiz - MUDOBEL S.L.

c/ Pitágoras, nave 5, parcela 4.
Polígono Industrial "Roces"
33211 - Gijón

Tel. 985 168 983 - 619 881 402
Fax: 985 167 002
Mail: adolfo@mudobel.com

ANDALUCÍA OCCIDENTAL

Manuel Pavón Segovia

c/Zapillo, 7 1º B.
41020 - Sevilla

Tel. 954 073 205 - 654 509 839
Mail: m.rossman@hotmail.com

ANDALUCÍA ORIENTAL

BEFRISA

c/ Atenas, nave 48
Polígono Industrial "San Luís"
29006 - Málaga

Tel. 952 338 696 - 637 549 939
Fax: 952 345 566
Mail: info@befrisa.com

BALEARES

**José Llabrés -
DISMATEC S.A.**

c/ Ausias March 10 Bis
07003 - Palma de Mallorca

Tel. 971 421 517 - 630 083 760
Fax: 971 420 783
Mail: dismatec@dismatecsa.com

CASTILLA Y LEÓN

Paulino Cangas

Los Arroxos, 64
33191 - Las Regueras (Asturias)

Tel. 609 665 254 - 670 594 986
Mail: paulo@delegadoastur.com

CATALUNYA / ARAGÓN

Cristina Carreira

Camí de la Cornisa, 7
08304 - Mataró (Barcelona)

Tel. 687 588 134
criscarreira@hotmail.com
cristicarreira@gmail.com

EXTREMADURA

**David Gallego -
DG DISTRIBUCIONES S.L.U.**

c/ Puerto Rico, 2
06800 - Mérida (Badajoz)

Tel. / Fax: 924 047 337
Mail: info@dgdistribuciones.es
www.dgdistribuciones.com

GALÍCIA

**Juan José Espejo -
ESCOHOSTEL S.L.**

c/ Pintor Carlos Maside, 52
36212 - Vigo (Pontevedra)

Tel. 609 850 155
Mail: escohostel@escohostel.com

GRAN CANARIA

**Antonio Ventura -
FRIGICOLL S.A.**

c/ Los Llanillos, 19- Pol. Ind. Las Majore-
reras - 35240 - El Carrizal (Ingenio)

Tel. 928 734 180 - 692 599 592
Fax: 928 734 177
Mail: antonio.ventura@frigicoll.es

NORTE / NAVARRA

**Santiago Uriarte -
REFRIMAK HOSTELERÍA S.L.**

c/ Gorbeia, 33 - Pol. Ind. Leguizamón
48450 - Etxebarri (Bizkaia)

Tel. 944 262 028
Fax: 944 263 064
Mail: refrimakhosteleria@gmail.com

TENERIFE

**Giselle García -
FRIGICOLL S.A.**

La Campana, 14 - Pol. Ind. San Isidro
38108 - El Rosario

Tel. 922 626 441 - 654 680 195
Fax: 922 624 604
Mail: giselle.garcia@frigicoll.es

LEVANTE

Jose Javier Montesinos -

c/ Llauradors, 1 Puerta 20
46119 - Náquera (Valencia)

Tel. 687 533 737
levante@mainho.com

FRANCE CP BERTHIER

14 Impasse des Chardons
31140 - AUCAMVILLE (France)
Tel. +33 (0) 0490026392

Mail: contact@materielhotelier.com

FÁBRICA Y OFICINAS MAINHO S.L.U.

c/Juan de la Cierva, 4 - Naves B C D K L
Pol. Ind. Can Galobardes - 08420
Canovelles (Barcelona)

Tel. 938 498 588
Fax: 938 463 119
Mail: mainho@mainho.com
export@mainho.com



MAINHO[®]

MAQUINARIA INDUSTRIAL HOSTELERA S.L.U.

Calle Juan de la Cierva, 4 - Polígono Industrial "Can Galobardes"
08420 - Canovelles - Barcelona - Spain
+34 938 498 588 - mainho@mainho.com - pedidos@mainho.com
www.mainho.com