

23



comas

comas

**Mantén el catálogo
siempre actualizado**



**Keep the catalogue
always updated**



1991-2023

1996

Comas adquiere la fabrica de cuberterías Arkaute. Se inicia nuestra aventura industrial.

Comas acquires the Arkaute cutlery factory. Our industrial adventure begins.

2004

Nace la cubertería Barcelona, uno de nuestros modelos más icónicos. Comas apuesta por dar un valor añadido a sus colecciones estudiando minuciosamente el diseño de cada colección.

Creation of **Barcelona** cutlery, one of our most iconic ranges. Comas seeks to maximise the added value of its collections with painstaking attention to the design of each collection.



2019

Nueva estrategia comercial: pasamos del monoprodueto al multiprodueto para especializarnos en las diferentes zonas de servicio de la restauración.

Our business strategy: to move from single-product to multi-product to become experts in the different service areas involved in the restaurant industry.



2021

Ampliación de las instalaciones en Lliçà d'Amunt. Una nueva ubicación de 5.000m2 con capacidad para 10.000 palets.

Extension of our facilities in Lliçà d'Amunt. A new 5.000 square metre location with capacity for 10.000 pallets.



2023

Damos un giro a nuestro concepto de marca. CULTER desaparece y surge COMAS AUTOR para dar nombre a todas las colecciones de diseño propio.

We give a twist to our brand concept. CULTER disappears and COMAS AUTHOR is created to give name to all our own design collections.



Creación de la compañía con la venta de estoc procedente de una liquidación de fabricas de Portugal. Nuestro primer almacén se ubica en el garaje de la casa familiar.

The company was started with the sale of stock from some factories in Portugal that were closing down. Our first warehouse was the garage of our home.

1991



Nos trasladamos a las nuevas instalaciones de Cardedeu. Se moderniza la fabrica de la mano de un socio italiano.

The company moved to new premises in Cardedeu. The factory was modernised by a shareholder from Italy.

2000

Creación de Culter, la nueva marca de Comas de alto standing que tiene como objetivo llegar a los chefs más exigentes.

Creation of Culter, Comas new prestige brand whose aim is to be seen on the tables of the most demanding chefs.

culter

2016

Comas se introduce con fuerza en el mundo del catering presentando LES ESSENCES. Una novedosa colección pensada para ofrecer un servicio integral en el sector del catering.

Comas makes a strong entry into the world of catering by presenting LES ESSENCES. A new collection designed to offer a comprehensive service in the catering sector.



2020



Sale a la venta la colección Atlántida que rinde homenaje al 30 aniversario de Comas.

The *Atlántida* collection, which pays tribute to the 30th anniversary of Comas, goes on sale.



2022

comas

COMAS es la demostración de que cotidianidad y calidad pueden ir de la mano. Una apuesta decidida por la transparencia y la confianza, basada en un producto de calidad tanto para el mundo profesional como para hogar.

Nuestro objetivo es ampliar horizontes más allá de la mesa, ofreciendo soluciones globales dentro del sector de la hostelería profesional.

COMAS engloba tanto cubertería como menaje.

COMAS is proof that the everyday and quality can coexist. A strong commitment to transparency and trust, based on a well-designed, quality product that is competitive for commercial and domestic use alike.

Our aim is to broaden horizons beyond the table, offering global solutions within the professional catering sector.

COMAS includes both cutlery and kitchenware.



COMAS AUTOR es sinónimo de exclusividad. Cada colección ha sido diseñada pensando en ofrecer al chef una pieza original, de calidad, con la que pueda completar sus emplatados más creativos y para que el cliente pueda experimentar nuevas sensaciones y se sorprenda en cada plato.

Todas las colecciones de COMAS AUTOR son de diseño propio y han sido planteadas con nuestros diseñadores para conseguir colecciones premium.

COMAS AUTOR is synonymous of exclusivity. Each collection has been designed to offer to the chef an original, quality piece, with which he can complete his most creative dishes and so that the customer can experience new sensations and be surprised by each dish.

All COMAS AUTOR collections are of our own design and have been planned with our designers in order to achieve premium collections.



HONESTY

MAYOR CALIDAD AL MEJOR PRECIO

Nuestra prioridad es ofrecer la máxima calidad de nuestros productos al precio más competitivo del mercado con una orientación eficiente y personalizada. Aportamos fiabilidad y proximidad a nuestros clientes y eso nos otorga una fuerte implantación y presencia entre nuestros competidores.

HIGHEST QUALITY AT THE BEST PRICE

Our priority is to offer the best quality product at the most competitive price in the market, with efficiency and the personal touch. We work closely with our customers and they trust us. That gives us a strong position compared to our competitors.

I+D

ANALIZAMOS Y BUSCAMOS SOLUCIONES GLOBALES PARA EL SECTOR HORECA

Apostamos por el diseño exclusivo de nuestros productos buscando siempre la tendencia y la innovación. Nuestra iniciativa para crear piezas únicas nos ha sido reconocida con importantes premios del sector del diseño.

WE ANALYSE AND SEEK GLOBAL SOLUTIONS FOR THE HORECA SECTOR

We are committed to having exclusive designs for our products, in line with modern trends and innovations. We have gained recognition for our unique pieces with important design prizes.



KNOW HOW

MENTALIDAD INDUSTRIAL

El expertise productivo nos lleva a trabajar los materiales de la manera más eficaz con acabados que garantizan una calidad premium en nuestros productos. Esta experiencia nos permite ofrecer 5 años de garantía en todas nuestras colecciones.

INDUSTRIAL MENTALITY

Our expertise in manufacturing means that we use materials as efficiently as possible with finishes that ensure premium quality for our products. That experience allows us to offer a 5-year guarantee on all our collections.



Apostamos por un equipo interno de diseñadores de producto y colaboraciones externas a largo plazo para crear colecciones personales, únicas y exclusivas. Los mejores profesionales del sector nos acompañan en la creación de productos y marcas innovadoras. Equipos formados por los diseñadores más técnicos y los ingenieros más creativos de Barcelona.

También colaboramos con la Universitat de Barcelona y la escuela de diseño e ingeniería Elisava. Proponemos un gran reto a los estudiantes: diseñar, con ayuda del equipo de Comas, una colección novedosa para el sector. Colaboraciones que suponen un win-win para ambas partes y que se han vuelto imprescindibles.

We are committed to an internal team of product designers and long-term external collaboration too create personal, unique and exclusive collections. The best Design professionals, join us to create innovative products and brands. Teams made by Barcelona's most technical designers and the most creative engineers.

We also collaborate with the University of Barcelona and the Elisava School of Design and Engineering. We propose a great challenge to the students: to design, with the help of the Comas team, a new collection for the market. Collaborations that represent a win-win for both parties and that have become essential.



ELISAVA Escuela Universitaria de Barcelona
Diseño e Ingeniería



2018

ASTER



MAGNOLIA



BAOBAB



2019

ASTER



BAOBAB



KODAI



2020

SAKURA



LAB



LAB



2021

LES
ESSENCES



LAB
ACCESORIES



2022

ATLÁNTIDA



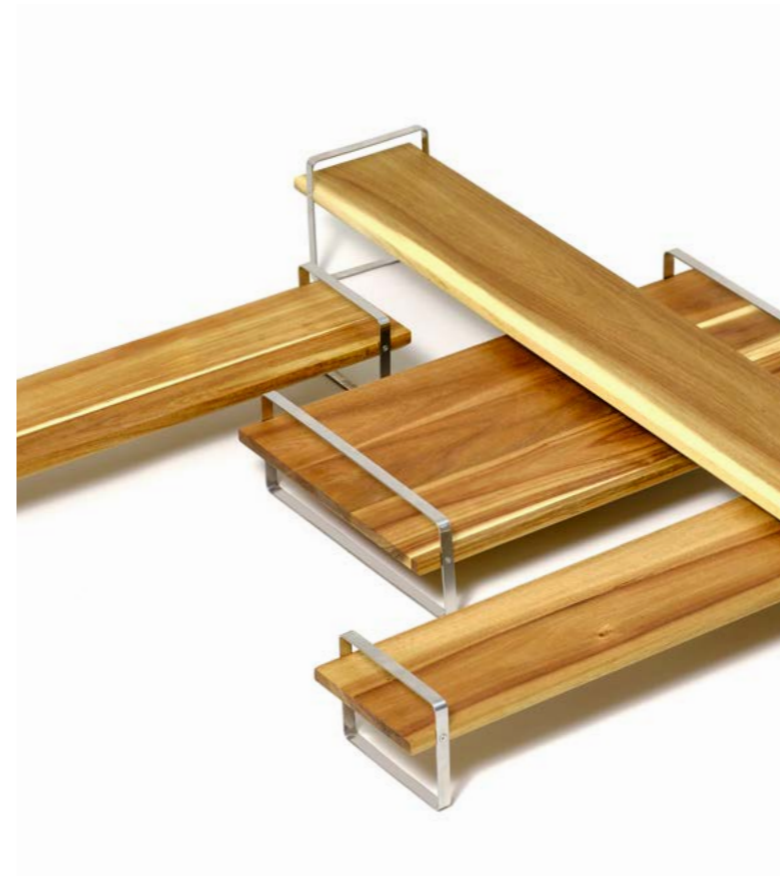

Nuestro equipo de diseño trabaja para aportar soluciones a los desafíos que año tras año les planteamos.

Nos sentimos orgullosos de poder trabajar en nuevos proyectos que son el resultado de un proceso creativo estudiado y madurado, donde el objetivo es obtener una colección exclusiva que cubra las necesidades de los chefs.

Las medidas, las texturas, los materiales, los colores... todo cuenta a la hora de decidir. Queremos ofrecer conceptos sorprendentes que no dejen indiferente a nadie.

Our design team works hard to provide solutions to the problem we set them year after year.

We are proud to be able to work on new projects – projects that are the outcome of a polished and measured creative process whose aim is to produce an exclusive collection that meets the needs of chefs.

Dimensions, textures, materials, colours – everything needs to be considered. We want to offer surprising products that everyone will have a view on.



comas



El rápido crecimiento de la compañía durante este 2022 nos ha obligado a trasladarnos a unas nuevas instalaciones en Lliçà d'Amunt, a tan sólo 30 km de la ciudad de Barcelona.

Due to the rapid growth of the company, in 2022 we moved to a new warehouse in Lliçà d'Amunt, located just 30 km from Barcelona city.

CAPACIDAD

CAPACITY

Las nuevas instalaciones tienen una superficie de 5.000 m² repartidos en 3 plantas. Gracias a este cambio, ahora, el almacén cuenta con una capacidad de 10.000 palets.

The new facilities have a surface area of 5,000 m² spread over 3 floors. Thanks to this change, the warehouse now has a capacity of 10,000 pallets.



SHOWROOM

SHOWROOM

En nuestro nuevo showroom, tenemos expuestos todos nuestros artículos para que nuestras visitas puedan conocerlos de primera mano.

In the new showroom, we have a wide variety of items on display so that our visitors can see them first-hand.



EQUIPO COMAS

COMAS TEAM

El equipo COMAS ha ido aumentando a lo largo de 2022, reforzando así, todos los departamentos de la compañía.

The COMAS team has been increasing throughout 2022, thus reinforcing all COMAS departments.



Conócenos
más



Nuestro mercado es global y así lo refleja el plan estratégico de la compañía, que prevé potencial la exportación en los próximos años.

Our market is global and our strategic plan reflects that reality, projecting rising exports over the next few years.



PRESENTES EN 57 PAÍSES
PRESENT IN
57 COUNTRIES

+ 1500 DISTRIBUIDORES
+ 1500
DISTRIBUTORS

40 EMPLEADOS INTERNOS
40 DIRECT
EMPLOYEES

34 COMERCIALES EXTERNOS
34 COMMERCIAL
AGENTS

PAÍSES DONDE TENEMOS PRESENCIA
COUNTRIES WHERE WE ARE PRESENT

Germany, Belgium, Bulgaria, Burkina Faso, Cyprus, Croatia, Spain, United States of America, France, Greece, Hungary, Italy, Jordan, Lebanon, Lithuania, Luxembourg, Malta, Morocco, Mexico, Netherlands, Panama, Poland, Portugal, Andorra, U.K, Ireland, Slovakian, Rep., Dominican Rep., Reunion, Romania, Russia, Sweden, Tunisia, Ukraine, U.A.E, Austria, Chile, Denmark, Estonia, Georgia, Hong Kong, Iceland, Latvia, Moldova, Norway, Czech Republic, South Africa, Switzerland, Australia, Korea, Saudi Arabia, China, Peru, Finland, Kuwait, Sri Lanka...



ALMACÉN
WAREHOUSE

- Almacén en BCN de 4.800 m2.
- Almacén en Canarias de 250 m2.
- 2 almacenes en China de 3.000 m2 (Guangzhou y Tianjin).
- Warehouse in BCN of 4800 m2.
- Warehouse in the Canary Islands of 250 m2.
- 2 warehouse in China of 3.000 m2 (Guangzhou y Tianjin).

60% STOCK SOBRE VENTAS
60% STOCK OVER SALES.

95% de pedidos servidos en máximo 48 horas.
95 % of orders dispatched within 48 hours.

CIFRAS
FIGURES

Crecimiento del 80% en 2022 / EBITDA superior al 10% / facturación de 20 M.
Double digit growth in the last 5 years / EBITDA more than 10% / turnover €20 million.

OFICINA EN CHINA
OFFICE IN CHINA

Nueva oficina en China (Guangzhou).
New office in China (Guangzhou).

En los últimos años Comas ha trabajado para crear una compañía sostenible social y medioambientalmente.

Trabajamos la sostenibilidad desde fases iniciales de diseño, desarrollando ideas y acciones que contribuyan a reducir daños en nuestro planeta y eviten el agotamiento de recursos. Desarrollamos valores sostenibles en todos los ámbitos de la compañía para una correcta gestión ambiental de la empresa.

In recent years, Comas has been working to build a business that is sustainable both socially and environmentally.

We work to achieve sustainability from the early phases of design, concept development and take action to reduce harm to the planet and avoid over-use of resources. We follow values of sustainability in all areas of the business to ensure rigorous environmental management.



Trabajamos para desarrollar un proceso industrial sostenible con combustibles que contribuyen a reducir las emisiones de CO2.

We are working to develop a sustainable industrial process using fuel that helps to reduce CO2 emissions.



Diseñamos embalajes con materiales reciclables para crear el menor impacto medioambiental posible.

We are designing packaging with recyclable materials to reduce the environmental impact as far as possible.



Controlamos el vertido de residuos para proteger la sostenibilidad del planeta.

We monitor our waste disposal to protect the planet's sustainability.

**Renovamos el compromiso ISO
We renew our ISO commitment.**

Acredita que en Comas aplicamos medidas de gestión medioambiental, con el fin de reducir el impacto de nuestra empresa en el medio ambiente.

Shows that Comas implements an environmental management system in order to reduce the impact of our business on the environment.



Certifica tanto la calidad en nuestro sistema productivo como en los procesos logísticos, administrativos y de dirección de Comas.

Shows the quality of Comas' system of production and logistical, administrative and management processes.



COMAS AL LADO DE LOS CHEFS

COMAS NEXT TO THE CHEFS

Cada vez más chefs confían en Comas. Nuestro objetivo es ofrecer una amplia gama de productos de calidad que cubran las exigencias de todos los servicios del sector.

More and more, chefs are relying on Comas. Our goal is to have a wide range of high-quality products that meet the demands of every type of service in the hospitality industry.



Marc Ribas
Restaurante La Brutal
Restaurante La Taverna del Ciri



Oriol Escribà
Catering Oriol Escribà



Xavier Corominas
Catering Private Chef Empordà



Sergi Palacín
Restaurante HIU



Bego Rodrigo
Restaurante La Salita
 Estrella Michelin



Xavier Pellicer
Restaurante Xavier Pellicer
 Mejor restaurante de verduras del mundo 2018 y 2019



Desde 2022, los chefs Cañitas Maite, forman parte del equipo COMAS, siendo los embajadores de marca. Los jóvenes chefs emergentes, Javi Sanz y Juan Sahuquillo, han arrancado tan fuerte, que su trabajo ya ha sido reconocido con grandes premios:

Since 2022, the Cañitas Maite chefs have been part of the COMAS team, being brand ambassadors. The young emerging chefs, Javi Sanz and Juan Sahuquillo, have made a strong start and their work has already been recognized with great awards:

 **Mejor cocinero revelación 2021.**
Best revelation chef 2021.

 **Mejor croqueta Joselito.**
Best Joselito croquette.

 **Mejor escabeche.**
Best "escabeche".

 **Estrella Michelin 2023**
restaurante OBA.
Michelin Star 2023 OBA restaurant.

 **Estrella Verde Michelin 2023**
restaurante OBA.
Michelin Green Star 2023 OBA restaurant.

Los chefs albaceteños han podido comprobar la variedad y versatilidad de las piezas de la colección LAB, creando originales emplatados con sus conocidas elaboraciones.

The chefs from Albacete have been able to verify the variety and versatility of the pieces in the LAB collection, creating original dishes with their well-known preparations.





Nuestro objetivo es ampliar horizontes más allá de la mesa, ofreciendo soluciones globales dentro del sector de la hostelería profesional.

Our aim is to look beyond the dining table, offering global solutions within the hospitality industry.

**SOLUCIONES GLOBALES PARA HORECA PROFESIONAL:
HOTELES Y RESTAURANTES**

GLOBAL SOLUTIONS FOR THE HOSPITALITY INDUSTRY:
HOTELS AND RESTAURANTS



Nuestro catálogo sigue evolucionando para ser tu proveedor de referencia.

Our products are continuously evolving and expanding to be your go-to supplier.

Somos especialistas en soluciones para la hostelería profesional, sin perder nuestra característica vocación de servicio y compromiso de calidad.

We specialise in solutions for the hospitality industry, without losing sight of our values of service and quality.

SÍGUENOS EN REDES SOCIALES.
FOLLOW US IN SOCIAL MEDIA.

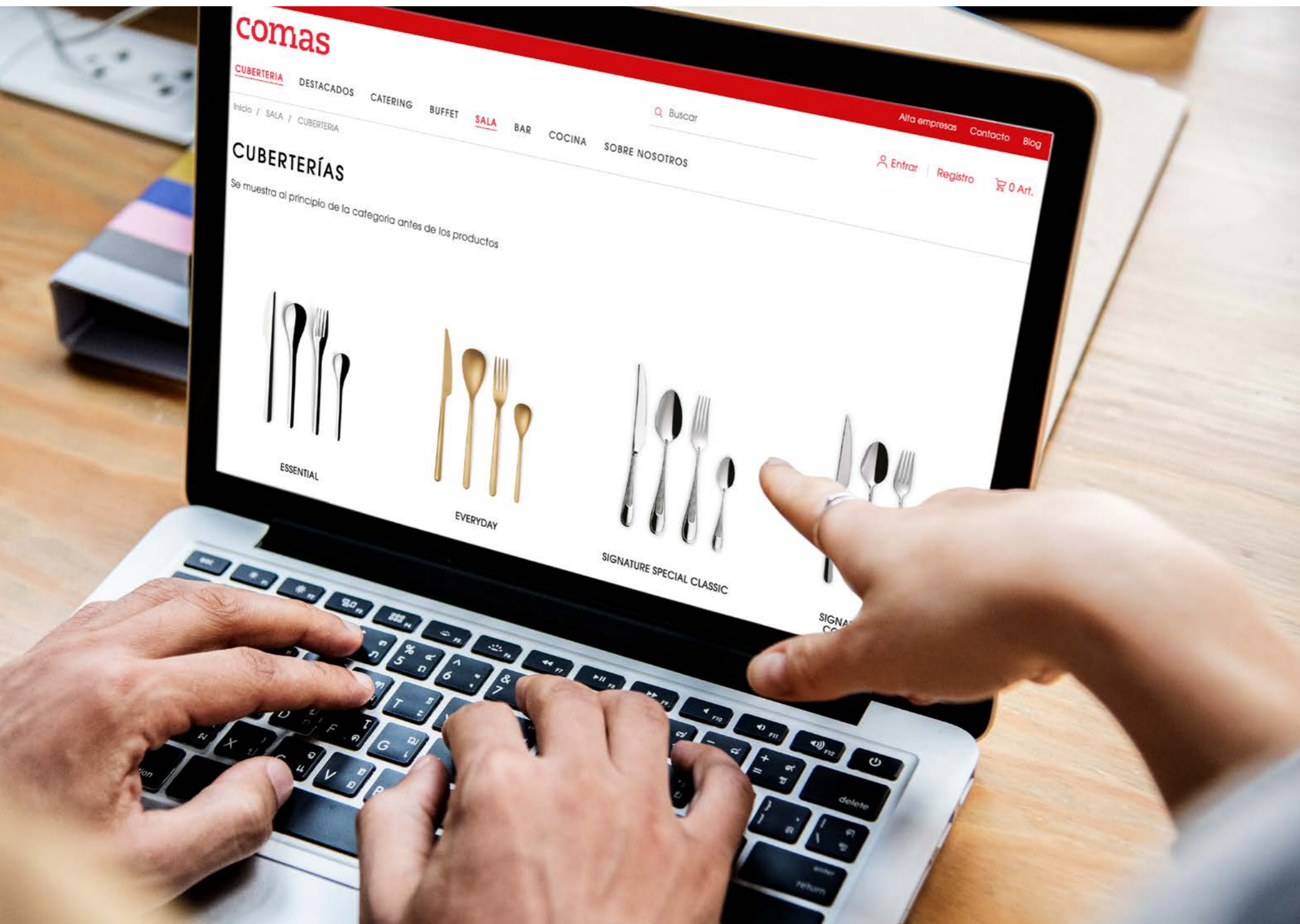

E-COMMERCE E-COMMERCE

En la nueva web encontrarás todos los artículos de nuestro catálogo, clasificados y categorizados para que tu compra sea más fácil e intuitiva.

You can see our whole catalogue on our new website, arranged by categories for intuitive purchasing.

TODO NUESTRO CATÁLOGO A UN CLICK OUR ENTIRE CATALOGUE AT A CLICK

Toda la información que necesitas de cada artículo, opciones de embalaje, fichas técnicas descargables, disponibilidad de stocks en tiempo real,...

All the information you need for each product, packaging options, downloadable product information sheets, real-time stock availability,...

HISTORIAL Y GESTIÓN DE PEDIDOS ORDER HISTORY AND MANAGEMENT

En tu usuario podrás consultar tu historial de pedidos, gestionar diferentes direcciones de envío y revisar facturas y albaranes.

You can view your order history, manage delivery address and review invoices and delivery notes on your user account.



@comasandpartners



@comasandpartners



@comas-and-partners



@comasandpartners

Visita nuestra
página web



MÁXIMO SERVICIO
MAXIMUM SERVICE

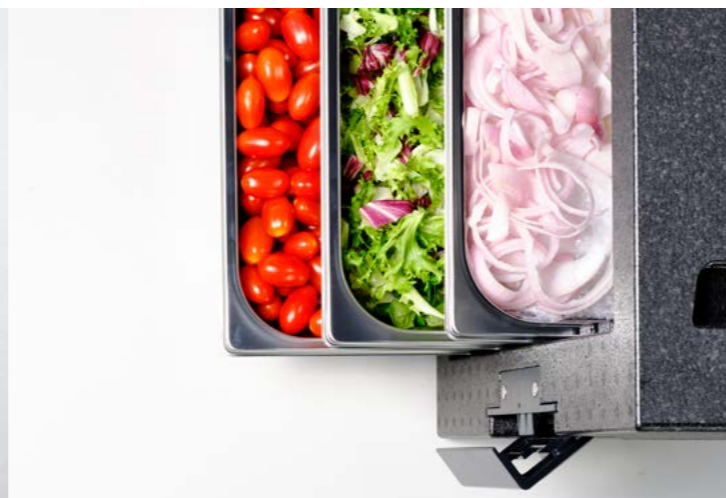

Presentamos los nuevos catálogos de distribuciones en exclusiva para el mercado HORECA España y Francia.

Con la intención de ofrecer un servicio más amplio a todos nuestros clientes, hemos alcanzado acuerdos de distribución en exclusiva con marcas de primer nivel en su categoría.

We present the new exclusive distribution catalogs for the HORECA market in Spain and France.

With the intention of offering a broader service to all our customers, we have reached exclusive distribution agreements with top-tier brands in their category.

Colaboradores exclusivos

Exclusive collaborators



Fabricante de primer nivel especialista en sartenes, cazuelas, planchas para horno y brasa.

First-class manufacturer specializing in frying pans, casseroles, oven and grill plates.

**Venta exclusiva en España y Francia. Para el resto de países, + 10% de contribución de transporte / Exclusive sale in Spain and France. For all other countries, +10% transport contribution.*



Especialista en cubetas GASTRONORM de acero inoxidable 18/10, policarbonato y polipropileno.

Specialist in GASTRONORM trays made of 18/10 stainless steel, polycarbonate and polypropylene.

**Venta exclusiva en España. Para el resto de países, + 10% de contribución de transporte / Exclusive sale in Spain. For all other countries, +10% transport contribution.*



Especialista en cajas isotérmicas de polipropileno para el transporte de alimentos en frío o en caliente.

Specialist manufacturer of polypropylene isothermal boxes for food transport in hot or cold.

**Venta exclusiva en España. Para el resto de países, + 10% de contribución de transporte / Exclusive sale in Spain. For all other countries, +10% transport contribution.*



Especialista en utensilios y maquinaria para repostería líder en su mercado, Italia.

Specialist in utensils and machinery for confectionery, leader in its market, Italy.

**Venta exclusiva en España. Para el resto de países, + 10% de contribución de transporte / Exclusive sale in Spain. For all other countries, +10% transport contribution.*

Contenido

Content



PRESENTACIÓN PRESENTATION

2-25 EMPRESA
COMPANY

CUBERTERÍA CUTLERY

28-131 INOX 18/10
18/10 STAINLESS STEEL



134-199 INOX 18%
18% STAINLESS STEEL



200-219 CHULETEROS
STEAK KNIVES



MENAJE COOKWARE

232-337 COCINA KITCHEN



CORTE



234

UTENSILIOS



258

PASTELERÍA



270

COCCIÓN



286

GASTRONORM



314

338-347 LOGÍSTICA LOGISTICS



GN



340

348-381 SALA DINING ROOM



VAJILLA



350

MINIATURAS



354

SERVICIO MESA



370

382-423 CATERING CATERING



LES ESSENCES



384

CALIU



408

BARBACOA



420

424-441 BUFFET BUFFET



CAJAS MADERA



426

ACCESORIOS



430

ELEGANT



432

PINZAS



436

442-453 BAR BAR



SERVICIO MESA



444

COCTELERÍA



446

ACCESORIOS



452

PERSONALIZADOS Y PLV
CUSTOM PACKS & PLV

454-455 CUSTOM PACKS



456-459 PLV



Cuartería

Cutlery

INOX 18/10

18/10 STAINLESS STEEL

- | | | | | | |
|----|----------------------------|-----|-------------------|-----|-------------|
| 30 | ATLÁNTIDA | 80 | OSLO | 109 | LOTUS |
| 36 | LAB | 81 | IRIS | 110 | ROSEWOOD |
| 38 | LAB VINTAGE COLORS | 82 | CALLAS | 112 | MUNICH |
| 42 | LAB ACCESSORIES | 83 | SANGIOVESE | 114 | IBIZA |
| 50 | SAKURA | 84 | SANGIOVESE COLORS | 115 | ONLINE |
| 52 | MARINA | 86 | PALMA | 116 | NORTH XL |
| 54 | MAGNOLIA | 88 | CONTOUR | 118 | NORTH M |
| 56 | SILEX | 90 | CONTOUR COLORS | 119 | NORTH S |
| 58 | KODAI | 92 | VERSAILLES | 120 | BAGUETTE XL |
| 62 | MINI KODAI | 94 | VERSAILLES COLORS | 122 | BAGUETTE S |
| 68 | FLEUR DE LYS | 98 | MARANTA | 124 | INGLÉS XL |
| 70 | FLEUR DE LYS VINTAGE BLACK | 100 | MARANTA VINTAGE | 126 | INGLÉS M |
| 72 | BAOBAB | 102 | LONDON | 127 | INGLÉS S |
| 74 | ASTER | 104 | LONDON VINTAGE | 128 | VIENA |
| 76 | EDELWEISS | 106 | VIOLET | 130 | BARCELONA |
| 77 | DALIA | 107 | TULIP | | |
| 78 | OAK | 108 | CHEF | | |

INOX 18%

18% STAINLESS STEEL

- | | | | | | |
|-----|-----------------------|-----|------------------|-----|-----------------|
| 134 | BCN SATIN | 161 | HIDRAULIC BLACK | 184 | ALIDA |
| 136 | BCN COLORS | 162 | MADRID | 186 | MART |
| 140 | BCN MARTELÉ | 164 | CUBA | 187 | HOTEL EXTRA XL |
| 141 | OSLO ECO | 166 | MIA | 188 | HOTEL EXTRA M |
| 142 | MALVARROSA | 168 | REPOSA CUBIERTOS | 190 | HOTEL EXTRA ECO |
| 144 | NICE | 169 | VIEUX PARIS | 191 | HOTEL |
| 146 | CANADA | 170 | SEVILLA XL | 192 | BROOKLYN |
| 148 | CANADA VINTAGE | 172 | SEVILLA S | 193 | TAKE AWAY |
| 149 | CANADA VINTAGE COLORS | 173 | SEVILLA VINTAGE | 194 | COLOMBIA |
| 152 | FINGER FOOD | 174 | GRANADA XL | 195 | ARABICA |
| 154 | SANTORINI | 176 | GRANADA S | 196 | 1001 |
| 156 | CHEF FREE | 178 | BILBAO XL | 197 | ECO |
| 157 | LOTUS FREE | 180 | BILBAO S | 198 | 1003 |
| 158 | KYOTO | 181 | OLYMPIA | 199 | NERVIO |
| 159 | CHEESE | 182 | LUNA | | |
| 160 | HIDRAULIC | 183 | LUNA SATIN BLACK | | |

OTROS OTHERS

- | | |
|-----|-------------------------|
| 123 | FABRICACIÓN CUBIERTOS |
| 132 | REVOLUTION KNIVES (RK) |
| 177 | MANTENIMIENTO CUBIERTOS |
| 220 | FINISHES - PVD |





Atlántida



Delta de Plata
Premios ADI 2022

Atlántida 



ATLÁNTIDA se concibe como una colección de cubertería que invita a explorar el misterio y dinamismo de una experiencia gastronómica contemporánea.

Atlántida is conceived as a collection of cutlery that invites you to explore the mystery and dynamism of a contemporary gastronomic experience.



**Conoce más
sobre Atlántida.**

ATLANTIDA CONCEPT
COMAS COLLECTION FAMILY
MESA - LUNCH - MOKA



ATLANTIDA MESA

ATLANTIDA LUNCH

MOKA



Las piezas destacan por su elegancia y minimalismo gracias a un discurso de líneas fluidas y el acabado sofisticado que le otorga el acero inoxidable texturizado.

The pieces stand out for their elegance and minimalism thanks to a discourse of fluid lines and the sophisticated finish given by textured stainless steel.

Esta colección, diseñada de la mano de Nacar Design, rinde homenaje a los 30 años de experiencia de la empresa, y una vez más, transmite su misión de querer acompañar y realzar el día a día de los profesionales y comensales

This collection, designed by the hand of Nacar Design, pays tribute to the company's 30 years of heritage and expertise. And once again, communicates its desire of accompanying and enhancing the day-to-day life of professionals and diners.



comas30 
YEARS



	€	UE	MOQ	✂ mm	✂ mm
A 8586 CUCHILLO MESA table knife, couteau table, coltello tavola, tafelmesser	5,24 €	0/6/60/1920/5760	60	226	
B 8587 CUCHARA MESA table spoon, cuillère table, cucchiaio tavola, tafellöffel	5,67 €	0/6/60/1920/5760	60	215	6
C 8588 TENEDOR MESA table fork, fourchette table, forchetta tavola, tafelgabel	5,77 €	0/6/60/1920/5760	60	218	6
D 8656 CUCHARA SALSA sauce spoon, cuillère à sauce, cucchiaio salsa, saucenlöffel	6,10 €	0/6/60/1920/5760	60	216	6
E 8589 CUCHILLO LUNCH cake knife, couteau gâteau, coltello dolce, kuchenmesser	4,71 €	0/6/60/1920/5760	60	169	
F 8591 CUCHARA LUNCH cake spoon, cuillère gâteau, cucchiaio dolce, lunch löffel	4,08 €	0/6/60/1920/5760	60	163	5
G 8590 TENEDOR LUNCH cake fork, fourchette gâteau, forchetta dolce, kuchengabel	4,13 €	0/6/60/1920/5760	60	160	5
H 8592 CUCHARA CAFÉ coffee/moka spoon, cuillère à sauce, cucchiaio moka, mokkalöffel	2,21 €	0/6/60/1920/5760	60	109	3,5
I 10431 REPOSA CUBIERTOS cutlery holder, plateau à couverts, porta posate, schneidewagen	36,52 €	0/4/48//			1,5
9773 24 PIEZAS 24 pieces, écriin 24 pièces, bauletto 24 pz., 24 stück	119,31 €	1/0/2/5/50	2		



	€	UE	MOQ	✂ mm	✂ mm
A 8579 CUCHILLO MESA table knife, couteau table, coltello tavola, tafelmesser	8,79 €	0/6/60/1920/5760	60	226	
B 8580 CUCHARA MESA table spoon, cuillère table, cucchiaio tavola, tafellöffel	9,23 €	0/6/60/1920/5760	60	215	6
C 8581 TENEDOR MESA table fork, fourchette table, forchetta tavola, tafelgabel	9,32 €	0/6/60/1920/5760	60	218	6
D 8655 CUCHARA SALSA sauce spoon, cuillère à sauce, cucchiaio salsa, saucenlöffel	9,47 €	0/6/60/1920/5760	60	216	6
E 8582 CUCHILLO LUNCH cake knife, couteau gâteau, coltello dolce, kuchenmesser	8,02 €	0/6/60/1920/5760	60	169	
F 8584 CUCHARA LUNCH cake spoon, cuillère gâteau, cucchiaio dolce, lunch löffel	7,40 €	0/6/60/1920/5760	60	163	5
G 8583 TENEDOR LUNCH cake fork, fourchette gâteau, forchetta dolce, kuchengabel	7,45 €	0/6/60/1920/5760	60	160	5
H 8585 CUCHARA CAFÉ coffee/moka spoon, cuillère à sauce, cucchiaio moka, mokkalöffel	5,33 €	0/6/60/1920/5760	60	109	3,5
9772 24 PIEZAS 24 pieces, écriin 24 pièces, bauletto 24 pz., 24 stück	198,68 €	1/0/2/5/50	2		



Lab



INOX 18/10 / 2mm / Mirror



reddot design award
winner 2020

2020 WINNER
EUROPEAN
PRODUCT
DESIGN
AWARD

Lab

INOX 18/10 / 2mm / Mirror



	€	UE	MOQ	✕ mm	✕ mm
A 7890 CUCHILLO MESA MONOBLOC monoblock table knife, couteau table monobloc, coltello tavola monobloc, monoblock tafelmesser	2,32 €	0/12/120/1920/7680	60	160	
B 6976 CUCHILLO MESA table knife, couteau table, coltello tavola, tafelmesser	2,07 €	0/12/120/5400/10800	60	160	2,5
C 6977 TENEDOR MESA table fork, fourchette table, forchetta tavola, tafelgabel	2,18 €	0/12/120/5400/10800	60	154	2
D 6978 CUCHARA MESA table spoon, cuillère table, cucchiaio tavola, tafellöffel	2,18 €	0/12/120/5400/10800	60	153	2
E 6979 TENEDOR ARROZ rice fork, fourchette à riz, forchetta riso, reispindel	2,03 €	0/12/120/5400/10800	60	148	2
F 6980 PINCHO cocktail stick, stick à cocktail, spiedo, spie	1,89 €	0/12/120/5400/16200	60	100	2
G 6981 PINCHO LARGO large cocktail stick, stick à cocktail long, spiedo lungo, langer spie	1,93 €	0/12/120/5400/16200	60	135	2
H 6982 TENEDOR APERITIVO appetizer fork, fourchette apéritif, forchetta antipasto, aperitif gabel	1,83 €	0/12/120/5400/16200	60	135	2
I 6983 CUCHARA APERITIVO appetizer spoon, cuillère apéritif, cucchiaio antipasto, aperitif löffel	1,83 €	0/12/120/5400/16200	60	135	2
J 6984 CUCHARA MOKA coffee/moka spoon, cuillère moka, cucchiaio moka, mokkalöffel	1,78 €	0/12/120/5400/16200	60	101	1,5
K 6985 CUCHARA LUNCH cake spoon, cuillère gâteau, cucchiaio dolce, lunch löffel	1,91 €	0/12/120/1920/7680	60	125	2
L 6986 TENEDOR LUNCH cake fork, fourchette gâteau, forchetta dolce, kuchengabel	1,91 €	0/12/120/5400/16200	60	125	2
M 7891 CUCHILLO LUNCH MONOBLOC monoblock cake knife, couteau gâteau monobloc, coltello dolce monobloc, monoblock kuchenmesser	2,35 €	0/12/120/5400/16200	60	135	
N 6987 CUCHILLO LUNCH cake knife, couteau gâteau, coltello dolce, kuchenmesser	1,81 €	0/12/120/5400/16200	60	135	
O 6988 CUCHARA COCTEL LARGA large cocktail, cuillère cocktail longue, cucchiaio cocktail lunga, cocktail löffel-lang	2,35 €	0/12/120/5400/10800	60	215	2
P 6989 CUCHARA CAFÉ ESPATULA spatula coffee spoon, cuillère spatule, cucchiaio spatola, kaffeelöffel	1,82 €	0/12/120/5400/16200	60	108	2
Q 6995 PINZA LARGA long caliper, pince longue, molla lunga, lange zange	4,76 €	0/6/60/5400/10800	6	222	2
R 6996 PINZA CORTA short caliper, pince courte, molla corta, kurze zange	4,22 €	0/6/60/5400/10800	6	160	2
S 6997 PINZA ESPÁTULA spatula caliper, pince spatule, molla spatola, kochzange	4,76 €	0/6/60/5400/10800	6	160	2
T 6998 CUCHARA DEGUSTACION tasting spoon, cuillère dégustation, cucchiaio degustazione, probierlöffel	3,73 €	0/6/60/5400/10800	6	86	2
V 6999 CUCHARA DEGUSTACION OVAL oval tasting spoon, cuillère dégustation ovale, cucchiaio degustazione ovale, probierlöffel oval	4,00 €	0/6/60/5400/10800	6	101	2





Lab Colors



INOX 18/10 / 2mm / Vintage Gold

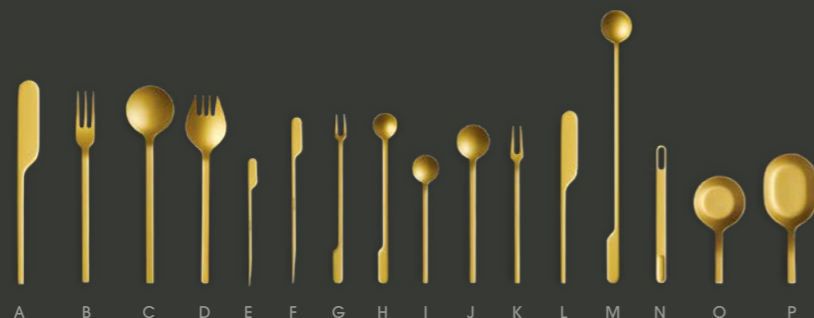

Lab Colors Vintage Gold

INOX 18/10 / 2mm / Vintage Gold



	€	UE	MOQ	▶ mm	✕ mm
A 1539 CUCHILLO MESA MONOBLOC monoblock table knife, couteau table monobloc, coltello tavola monobloc, monoblock tafelmesser	3,97 €	0/12/120/5400/10800	60	160	
B 1541 TENEDOR MESA table fork, fourchette table, forchetta tavola, tafelgabel	3,79 €	0/12/120/5400/10800	60	154	2
C 1540 CUCHARA MESA table spoon, cuillère table, cucchiaio tavola, tafellöffel	3,79 €	0/12/120/5400/10800	60	153	2
D 1542 TENEDOR ARROZ rice fork, fourchette à riz, forchetta riso, reispindel	3,79 €	0/12/120/5400/10800	60	148	2
E 1543 PINCHO cocktail stick, stick à cocktail, spiedo, spie	4,08 €	0/12/120/5400/10800	60	100	2
F 1544 PINCHO LARGO large cocktail stick, stick à cocktail long, spiedo lungo, langer spie	4,08 €	0/12/120/5400/10800	60	135	2
G 1545 TENEDOR APERITIVO appetizer fork, fourchette apéritif, forchetta antipasto, aperitif gabel	3,56 €	0/12/120/5400/10800	60	135	2
H 1546 CUCHARA APERITIVO appetizer spoon, cuillère apéritif, cucchiaio antipasto, aperitif löffel	3,56 €	0/12/120/5400/10800	60	135	2
I 1547 CUCHARA MOKA coffee/moka spoon, cuillère moka, cucchiaio moka, mokkalöffel	3,19 €	0/12/120/5400/10800	60	101	1,5
J 1549 CUCHARA LUNCH cake spoon, cuillère gâteau, cucchiaio dolce, lunch löffel	3,37 €	0/12/120/5400/10800	60	125	2
K 1550 TENEDOR LUNCH cake fork, fourchette gâteau, forchetta dolce, kuchengabel	3,83 €	0/12/120/5400/10800	60	125	2
L 1548 CUCHILLO LUNCH MONOBLOC monoblock cake knife, couteau gâteau monobloc, coltello dolce monobloc, monoblock kuchenmesser	3,80 €	0/12/120/5400/10800	60	135	
M 1551 CUCHARA COCTEL LARGA large cocktail, cuillère cocktail longue, cucchiaio cocktail lunga, cocktail löffel-lang	3,88 €	0/12/120/5400/10800	60	215	2
N 1552 CUCHARA CAFÉ ESPATULA spatula coffee spoon, cuillère spatule, cucchiaio spatola, kaffeelöffel	3,47 €	0/12/120/5400/10800	60	108	2
O 1553 CUCHARA DEGUSTACION tasting spoon, cuillère dégustation, cucchiaio degustazione, probierlöffel	6,70 €	0/6/60/5400/10800	60	86	2
P 1554 CUCHARA DEGUSTACION OVAL oval tasting spoon, cuillère dégustation ovale, cucchiaio degustazione ovale, probierlöffel oval	7,16 €	0/6/60/5400/10800	60	101	2





Lab Colors Vintage Copper

INOX 18/10 / 2mm / Vintage Copper



Lab Colors Ice Black

INOX 18/10 / 2mm / Ice Black

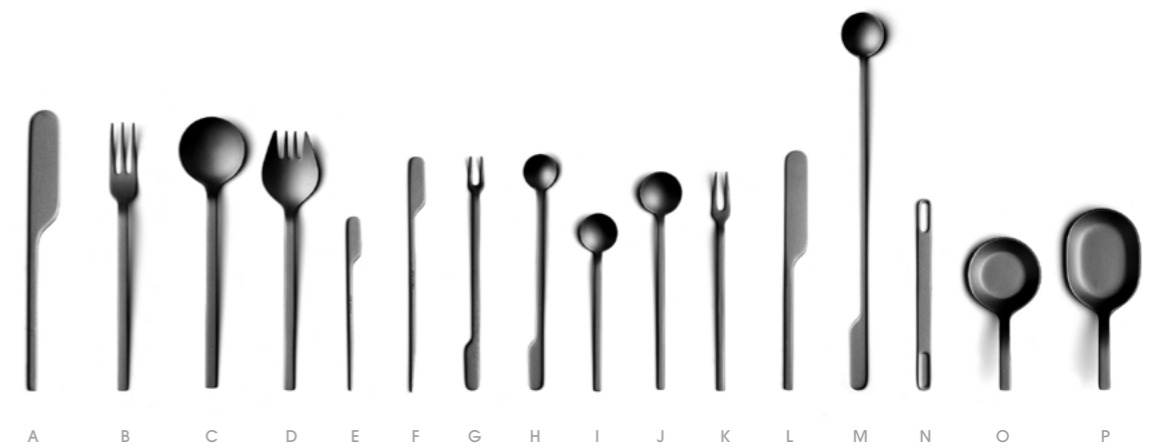

		€	UE	MOQ	▶ mm	✕ mm
A	1555 CUCHILLO MESA MONOBLOC monoblock table knife, couteau table monobloc, coltello tavola monobloc, monoblock tafelmesser	4,20 €	0/12/120/5400/10800	60	160	
B	1557 TENEDOR MESA table fork, fourchette table, forchetta tavola, tafelgabel	4,02 €	0/12/120/5400/10800	60	154	2
C	1556 CUCHARA MESA table spoon, cuillère table, cucchiaio tavola, tafellöffel	4,02 €	0/12/120/5400/10800	60	153	2
D	1558 TENEDOR ARROZ rice fork, fourchette à riz, forchetta riso, reispindel	4,02 €	0/12/120/5400/10800	60	148	2
E	1559 PINCHO cocktail stick, stick à cocktail, spiedo, spie	4,08 €	0/12/120/5400/10800	60	100	2
F	1560 PINCHO LARGO large cocktail stick, stick à cocktail long, spiedo lungo, langer spie	4,08 €	0/12/120/5400/10800	60	135	2
G	1561 TENEDOR APERITIVO appetizer fork, fourchette apéritif, forchetta antipasto, aperitif gabel	3,79 €	0/12/120/5400/10800	60	135	2
H	1562 CUCHARA APERITIVO appetizer spoon, cuillère apéritif, cucchiaio antipasto, aperitif löffel	3,79 €	0/12/120/5400/10800	60	135	2
I	1563 CUCHARA MOKA coffee/moka spoon, cuillère moka, cucchiaio moka, mokkalöffel	3,42 €	0/12/120/5400/10800	60	101	1,5
J	1565 CUCHARA LUNCH cake spoon, cuillère gâteau, cucchiaio dolce, lunch löffel	3,60 €	0/12/120/5400/10800	60	125	2
K	1566 TENEDOR LUNCH cake fork, fourchette gâteau, forchetta dolce, kuchengabel	4,07 €	0/12/120/5400/10800	60	125	2
L	1564 CUCHILLO LUNCH MONOBLOC monoblock cake knife, couteau gâteau monobloc, coltello dolce monobloc, monoblock kuchenmesser	4,07 €	0/12/120/5400/10800	60	135	2
M	1567 CUCHARA COCTEL LARGA large cocktail, cuillère cocktail longue, cucchiaio cocktail lunga, cocktail löffel-lang	4,11 €	0/12/120/5400/10800	60	215	2
N	1568 CUCHARA CAFÉ ESPATULA spatula coffee spoon, cuillère spatule, cucchiaio spatola, kaffeelöffel	3,70 €	0/12/120/5400/10800	60	108	2
O	1569 CUCHARA DEGUSTACION tasting spoon, cuillère dégustation, cucchiaio degustazione, probierlöffel	6,93 €	0/6/60/5400/10800	60	86	2
P	1570 CUCHARA DEGUSTACION OVAL oval tasting spoon, cuillère dégustation ovale, cucchiaio degustazione ovale, probierlöffel oval	7,39 €	0/6/60/5400/10800	60	101	2



		€	UE	MOQ	▶ mm	✕ mm
A	8640 CUCHILLO MESA MONOBLOC monoblock table knife, couteau table monobloc, coltello tavola monobloc, monoblock tafelmesser	4,20 €	0/12/120/5400/10800	60	160	
B	7665 TENEDOR MESA table fork, fourchette table, forchetta tavola, tafelgabel	4,02 €	0/12/120/5400/10800	60	154	2
C	8641 CUCHARA MESA table spoon, cuillère table, cucchiaio tavola, tafellöffel	4,02 €	0/12/120/5400/10800	60	153	2
D	8642 TENEDOR ARROZ rice fork, fourchette à riz, forchetta riso, reispindel	4,02 €	0/12/120/5400/10800	60	148	2
E	8643 PINCHO cocktail stick, stick à cocktail, spiedo, spie	4,08 €	0/12/120/5400/10800	60	100	2
F	8644 PINCHO LARGO large cocktail stick, stick à cocktail long, spiedo lungo, langer spie	4,08 €	0/12/120/5400/10800	60	135	2
G	8645 TENEDOR APERITIVO appetizer fork, fourchette apéritif, forchetta antipasto, aperitif gabel	3,79 €	0/12/120/5400/10800	60	135	2
H	8646 CUCHARA APERITIVO appetizer spoon, cuillère apéritif, cucchiaio antipasto, aperitif löffel	3,79 €	0/12/120/5400/10800	60	135	2
I	8647 CUCHARA MOKA coffee/moka spoon, cuillère moka, cucchiaio moka, mokkalöffel	3,42 €	0/12/120/5400/10800	60	101	1,5
J	8649 CUCHARA LUNCH cake spoon, cuillère gâteau, cucchiaio dolce, lunch löffel	3,60 €	0/12/120/5400/10800	60	125	2
K	8650 TENEDOR LUNCH cake fork, fourchette gâteau, forchetta dolce, kuchengabel	4,07 €	0/12/120/5400/10800	60	125	2
L	8648 CUCHILLO LUNCH MONOBLOC monoblock cake knife, couteau gâteau monobloc, coltello dolce monobloc, monoblock kuchenmesser	4,07 €	0/12/120/5400/10800	60	135	2
M	8651 CUCHARA COCTEL LARGA large cocktail, cuillère cocktail longue, cucchiaio cocktail lunga, cocktail löffel-lang	4,11 €	0/12/120/5400/10800	60	215	2
N	8652 CUCHARA CAFÉ ESPATULA spatula coffee spoon, cuillère spatule, cucchiaio spatola, kaffeelöffel	3,70 €	0/12/120/5400/10800	60	108	2
O	8653 CUCHARA DEGUSTACION tasting spoon, cuillère dégustation, cucchiaio degustazione, probierlöffel	6,93 €	0/6/60/5400/10800	60	86	2
P	8654 CUCHARA DEGUSTACION OVAL oval tasting spoon, cuillère dégustation ovale, cucchiaio degustazione ovale, probierlöffel oval	7,39 €	0/6/60/5400/10800	60	101	2





Lab Accessories

Lab Accessories 
Servicio mesa / Table top



reddot design award
winner 2021

Comas presenta la nueva colección LAB ACCESSORIES. Un conjunto de platos y bases para servir, en diferentes materiales y colores que junto a la ya existente cubertería de Culter, te permitirá completar la experiencia de degustar aperitivos, tapas y arroces.

Todos los elementos de la colección siguen las mismas proporciones, ayudándote a crear múltiples composiciones, jugando con la modularidad y la combinación de colores, materiales y texturas.

Nuestros embajadores de marca, los chefs Cañitas Maite, han podido comprobar la versatilidad de la colección, creando originales emplatados de sus conocidas elaboraciones. La combinación de sus recetas con las piezas LAB es espectacular.

Comas introduces its new LAB ACCESSORIES collection. A collection of dishes and serving platters in different materials and colours that goes perfectly with Culter's existing serving ware for you to make the experience of savouring canapés, tapas and rice dishes complete.

All the items in the collection are in the same proportions, so that you can create different compositions by exploiting their modularity and the combinations of colours, materials and textures.

The Cañitas Maite chefs, our Brand Ambassadors, have seen for themselves how versatile the collection is, serving their renowned confections in original ways. The combination of their dishes and the pieces from the LAB collection is spectacular.



Descubre la modularidad de LAB

Vermut, tapas y arroces / Cocktail, tapas and rice dishes



Bandejas y soportes fabricados en aluminio para conseguir la mayor ligereza. Con formas polivalentes que optimizan las posibilidades de uso de cada una de ellas.

Trays and supports made of aluminium for maximum lightness. With multi-purpose shapes that optimise the possibilities of use of each one of them.

Juega
Play

No importa el estilo en el que estés pensando para tus emplatados, la variedad de formatos, colores y texturas que ofrece la colección LAB abren un abanico de posibilidades a la hora de presentar cualquier elaboración culinaria.

No matter what style you are considering for service, the variety of forms, colours and textures that the LAB collection offers opens up a panoply of possibilities for the presentation of any culinary offering.

Presentaciones únicas
Unique presentations

El plato no es sólo el soporte, es el elemento que completa una receta. La variedad de formas, texturas y colores de la colección LAB, permiten crear una experiencia gastronómica única, creando el conjunto idóneo para una presentación excepcional.

A dish is not a mere container, it is what completes a recipe. The diversity of forms, textures and colours in the LAB collection allow you to create a unique gastronomic experience with the ideal combination of serving ware to present food in a truly exceptional way.



**Conoce más sobre
LAB Accesorios**



Plato 1/4 ración redondo

1/4 ration circle plate
plateau 1/4 bassin rond
vassoio 1/4 porzione rotonda
1/4 portion quadratischer edelstahl teller

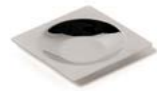

REF.	W(mm)	L(mm)	€	UE / MOQ
8000	92,5	92,5	15,13	0-4-16-0-0 / 4

Plato 1/4 ración redondo doble

1/4 ration circle double plate
plateau 1/4 double bassin rond
vassoio 1/4 porzione doppia
1/4 portion rechteckiger edelstahl teller doppelt



REF.	W(mm)	L(mm)	€	UE / MOQ
8004	92,5	185	20,64	0-4-16-0-0 / 4

Plato 1 ración oval

1 ration oval plate
plateau bassin ovale
vassoio 1 porzione ovale
1 portion rechteckiger edelstahl teller



REF.	W(mm)	L(mm)	€	UE / MOQ
8005	92,5	278	29,30	0-4-16-0-0 / 4

Plato 1 ración redondo

1 ration circle plate
plateau bassin rond
vassoio 1 porzione rotonda
1 portion quadratischer edelstahl teller

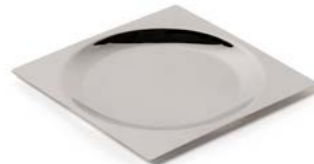

REF.	W(mm)	L(mm)	€	UE / MOQ
8002	185	185	19,57	0-4-16-0-0 / 4

Plato 1/2 ración oval

1/2 ration oval plate
plateau 1/2 bassin ovale
vassoio 1/2 porzione ovale
ovale 1/2 portion rechteckiger edelstahl teller

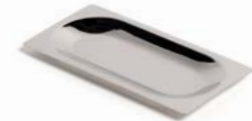

REF.	W(mm)	L(mm)	€	UE / MOQ
8003	92,5	185	18,90	0-4-16-0-0 / 4

Plato 1/2 ración oval + pinchos

1/2 ration oval plate + stick holder
plateau 1/2 bassin ovale + porte brochette
vassoio 1/2 porzione ovale + fori spiedini
1/2 portion rechteckiger edelstahl teller mit spießhalter



REF.	W(mm)	L(mm)	€	UE / MOQ
8006	92,5	278	29,30	0-4-16-0-0 / 4

Plato 1 ración redondo PVD

PVD 1 ration circle plate
plateau bassin rond PVD
vassoio 1 porzione rotonda PVD
PVD 1 portion quadratischer edelstahl teller



ACABADO
ICE
ICE FINISH

REF.	COLOR	W(mm)	L(mm)	€	UE / MOQ
8604	ORO	185	185	23,46	0-4-16-0-0 / 4
8605	COBRE	185	185	23,46	0-4-16-0-0 / 4
8606	NEGRO	185	185	23,46	0-4-16-0-0 / 4

Plato 1/2 ración oval PVD

PVD 1/2 ration oval plate
plateau 1/2 bassin ovale PVD
vassoio 1/2 porzione ovale PVD
PVD ovale 1/2 portion rechteckiger edelstahl teller



ACABADO
ICE
ICE FINISH

REF.	COLOR	W(mm)	L(mm)	€	UE / MOQ
8607	ORO	92,5	185	21,57	0-4-16-0-0 / 4
8608	COBRE	92,5	185	21,57	0-4-16-0-0 / 4
8609	NEGRO	92,5	185	21,57	0-4-16-0-0 / 4



Base porcelana pequeña
Simple porcelain tray
Plateau en porcelaine simple
Vassoio porcellana semplice
Einfaches porzellantablett

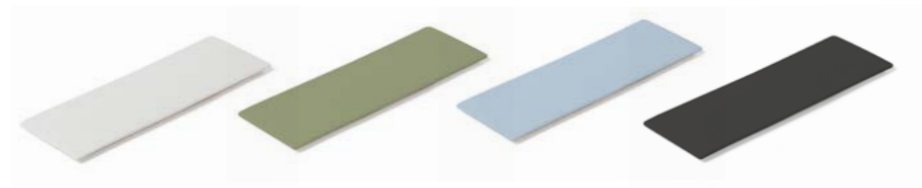

REF.	COLOR	W(mm)	L(mm)	€	UE / MOQ
8598	BLANCO	92,5	278	11,15	0-4-16-0-0 / 4
8600	VERDE	92,5	278	11,15	0-4-16-0-0 / 4
8602	AZUL	92,5	278	11,15	0-4-16-0-0 / 4
8596	NEGRO	92,5	278	11,15	0-4-16-0-0 / 4

Base porcelana grande
Double porcelain tray
Plateau en porcelaine double
Vassoio porcellana doppio
Doppeltes porzellantablett

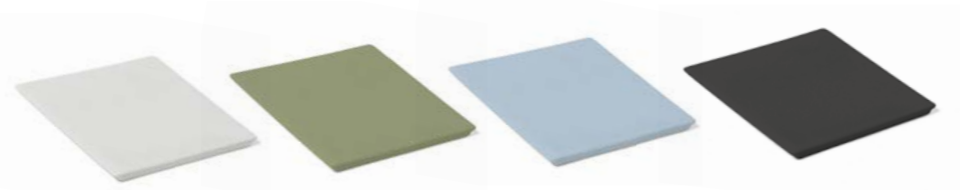

REF.	COLOR	W(mm)	L(mm)	€	UE / MOQ
8599	BLANCO	185	185	10,25	0-4-16-0-0 / 4
8601	VERDE	185	185	10,25	0-4-16-0-0 / 4
8603	AZUL	185	185	10,25	0-4-16-0-0 / 4
8597	NEGRO	185	185	10,25	0-4-16-0-0 / 4

Base madera
wood tray
plateau en bois
vassoio legno
holztablett



REF.	SIZE	W(mm)	L(mm)	€	UE / MOQ
8370	SIMPLE	92,5	278	6,18	0-4-16-0-0 / 4
8371	DOBLE	185	278	9,18	0-4-16-0-0 / 4

Disco pinchos
round stick holder
porte brochette rond
disco fori spiedini
runder edelstahl spießhalter



REF.	Ø(mm)	Para ref. / For ref.	€	UE / MOQ
8001	71	8000 - 8004	7,40	0-4-16-0-0 / 4

Plato gest
gest plate
plateau en porcelaine gest
vassoio porcellana gest
gest porzellantablett



NEW

REF.	H(mm)	W(mm)	L(mm)	€	UE / MOQ
9984	30	110	105	9,83	4





Sakura



INOX 18/10 / 5mm / Mirror



reddot design award
winner 2020

Sakura

INOX 18/10 / 5mm / Mirror



	€	UE	MOQ	▶ mm	✂ mm
A 6931 CUCHILLO MESA table knife, couteau table, coltello tavola, tafelmesser	5,86 €	0/6/60/1440/4320	60	228	
B 6932 CUCHARA MESA table spoon, cuillère table, cucchiaio tavola, tafellöffel	6,10 €	0/6/60/1440/4320	60	206	5
C 6933 TENEDOR MESA table fork, fourchette table, forchetta tavola, tafelgabel	6,10 €	0/6/60/1440/4320	60	210	5
D 6934 CUCHARA RAMEN ramen spoon, cuillère ramen, cucchiaio ramen, ramen löffel	6,58 €	0/6/60/1440/4320	60	192	5
E 6935 SET PALILLOS chopsticks set, set piques, set bacchette, e_stäbchen-set	3,55 €	0/6/60/1440/4320	60	230	5,5
F 6936 PLATO PALILLOS PORCELANA porcelain chopsticks plate, porcelaine assiette piques, piatto porcellana bacchette, e_stäbchen-teller porzellan	6,92 €	0/6/60/1440/4320	60		
G 7869 SOPORTE CUBIERTOS cutlery holder, panier à couverts, supporto coperte, besteckhalter	11,20 €	0/6/60/1440/4320	60	80	8,5
H 6937 CUCHARA ARROZ rice spoon, porcelaine cuillère riz, cucchiaio riso porcellana, reislöffel porzellan	5,19 €	0/6/60/1440/4320	60	108	5,5
I 6938 PLATO ARROZ PORCELANA porcelain rice plate, assiette riz, piatto riso, reisteller	6,92 €	0/6/60/1440/4320	60		
J 6939 TENEDOR LUNCH cake fork, fourchette gâteau, forchetta dolce, kuchengabel	3,41 €	0/6/60/1440/4320	60	151	3,5
K 6940 CUCHARA CAFÉ tea spoon, cuillère café, cucchiaio caffè, kaffeelöffel	3,36 €	0/6/60/1440/4320	60	147	3
L 6941 CUCHARA MOKA coffee/moka spoon, cuillère moka, cucchiaio moka, mokkalöffel	2,88 €	0/6/60/1440/4320	60	105	2
9790 16 PIEZAS 16 pieces, écriin 16 pièces, bauletto 16 pz., 16 Stück	81,79 €	1/0/2/5/50	2		5
9789 24 PIEZAS 24 pieces, écriin 24 pièces, bauletto 24 pz., 24 Stück	119,17 €	1/0/2/5/50	2		5
8704 30 PIEZAS 30 pieces, écriin 30 pièces, bauletto 30 pz., 30 Stück	137,59 €	1/0/2/5/50	2		5





Marina



INOX 18/10 / Mirror



Marina

INOX 18/10 / Mirror

Proyecto en colaboración con:

Xavier Pellier

U ELISAVA



	€	UE	MOQ	▶ mm	✂ mm
A 7558 SET CUCHARA + Tenedor ENSALADA set salad spoon + fork, set cuillère + fourchette à servir salade, set cucchiaio + forchetta servire, set salatlöffel + salatgabel	40,13 €	1/0/10/200/1000	10		
B 7556 PACK 6 CUCHARA SENSORIAL pack 6 sensorial remover, pack 6 cuillère sensoriel, pack 6 cucchiaio sensorial, pack 6 löffel sensorial	18,79 €	1/0/10/200/1000	10	102	
C 7557 PACK 6 CUCHARA SENSORIAL LARGA pack 6 sensorial long remover, pack 6 longue cuillère sensoriel, pack 6 cucchiaio lungo sensorial, pack 6 langer löffel sensorial	21,98 €	1/0/10/200/1000	10	150	





Magnolia



reddot design award
winner 2018

Magnolia

INOX 18/10 / 9mm / PVD Negro / Mirror



INOX 18/10 / 9mm / PVD Negro / Mirror



54



- A **6445** CUCHILLO CHULETERO K9 MAGNOLIA
k9 magnolia steak knife, couteau steak k9 magnolia, coltello bistecca k9 magnolia, steakmesser k9 magnolia
- B **6446** Tenedor Chuletero K9 Magnolia
k9 magnolia steak fork, fourchette steak k9 magnolia, forchetta bistecca k9 magnolia, steakgabel k9 magnolia

€	UE	MOQ	▶ mm	✕ mm
8,88 €	0/6/60/720/3600	6	226	
8,88 €	0/6/60/720/3600	6	203	9



55



Silex

Silex 

INOX 18/10 / Satin

Proyecto en colaboración con:



Proyecto seleccionado:

Nil Carbó Raventós



INOX 18/10 / Satin



	€	UE	MOQ	✂ mm	✂ mm
A 6318 CUCHILLO CHULETERO SILEX silex steak knife, couteau steak silex, coltello bistecca silex, steakmesser silex	29,60 €	1/0/20/130/390	20	185	
B 6319 TENEDOR CHULETERO SILEX silex steak fork, fourchette steak silex, forchetta bistecca silex, steakgabel silex	29,60 €	1/0/20/130/390	20	185	
6322 CUCHILLO + TENEDOR SILEX silex knife + fork, couteau + fourchette silex, coltello + forchetta silex, silex messer + gabel	71,03 €	1/0/8/72/216	8		





Kodai



INOX 18% Nickel Free / 3mm / Vintage



Kodai Vintage

INOX 18% Nickel Free / 3mm / Vintage



	€	UE	MOQ	▶ mm	✂ mm
A 7276 CUCHILLO MESA XL table knife xl vintage, couteau table xl vintage, coltello tavola xl vintage, tafelmesser xl vintage	3,70 €	0/12/120/2880/5760	60	212	
B 7279 CUCHARA MESA XL table spoon xl vintage, cuillère table xl vintage, cucchiaio tavola xl vintage, tafellöffel xl vintage	2,76 €	0/12/120/2880/5760	60	190	3
C 7285 TENEDOR MESA 3 PUAS XL table fork 3 prongs xl vintage, fourchette table xl 3 dents vintage, forchetta tavola xl 3 punte vintage, tafelgabel xl vintage	2,76 €	0/12/120/2880/5760	60	195	3
D 6943 CUCHILLO MESA vintage table knife, couteau table vintage, coltello tavola vintage, tafelmesser vintage	3,51 €	0/12/120/1800/9000	60	183	
E 6944 CUCHARA MESA vintage table spoon, cuillère table vintage, cucchiaio tavola vintage, tafellöffel vintage	2,50 €	0/12/120/1800/9000	60	170	2,5
F 6945 TENEDOR MESA 2 PUAS vintage table fork 2 prongs, fourchette table 2 dents vintage, forchetta tavola 2 punte, tafelgabel 2	2,50 €	0/12/120/1800/9000	60	179	2,5
G 6946 TENEDOR MESA 3 PUAS vintage table fork 3 prongs, fourchette table 3 dents vintage, forchetta tavola 3 punte, tafelgabel 3	2,50 €	0/12/120/1800/9000	60	163	2,5
H 6947 CUCHILLO MANTEQUILLA vintage butter knife, couteau beurre, coltello burro, buttermesser	3,28 €	0/12/120/1800/9000	60	155	
I 6948 CUCHILLO LUNCH vintage cake knife, couteau gâteau, coltello dolce, kuchenmesser	2,93 €	0/12/120/1800/9000	60	133	
J 6949 TENEDOR LUNCH vintage cake fork, fourchette gâteau, forchetta dolce, kuchengabel	1,98 €	0/12/120/1800/9000	60	138	2
K 6950 CUCHARA CAFÉ vintage coffee spoon, cuillère café, cucchiaio caffè, kaffeelöffel	1,98 €	0/12/120/1800/9000	60	115,4	1,7
L 6951 CUCHARA SIDE vintage side spoon, cuillère side, cucchiaio side, löffel side	2,62 €	0/12/120/1800/9000	60	93,5	2
M 6952 CUCHARA MOKA vintage moka spoon, cuillère moka, cucchiaio moka, mokkalöffel	2,19 €	0/12/120/1800/9000	60	97,5	1,7
N 6953 CUCHARA ARROZ vintage rice spoon, cuillère à riz, cucchiaio riso, reislöffel	5,00 €	0/12/120/1680/6720	60	90	2,5
O 6954 TENEDOR RASTRILLO vintage wide fork, fourchette râteau, forchetta wide, tafelgabel wide	4,52 €	0/12/120/1680/6720	60	113	2,5
9792 16 PIEZAS 16 pieces, écrin 16 pièces, bauletto 16 pz., 16 stück	48,95 €	1/0/2/5/50	2		3
9791 24 PIEZAS 24 pieces, écrin 24 pièces, bauletto 24 pz., 24 stück	70,19 €	1/0/2/5/50	2		3
8705 30 PIEZAS 30 pieces, écrin 30 pièces, bauletto 30 pz., 30 stück	80,91 €	1/0/2/5/50	2		3





Kodai Vintage Gold

INOX 18% Nickel Free / 3mm / Vintage Gold



	€	UE	MOQ	▶ mm	✂ mm
A 7278 CUCHILLO MESA XL table knife xl vintage, couteau table xl vintage, coltello tavola xl vintage, tafelmesser xl vintage	5,92 €	0/12/120/2880/5760	60	212	
B 7281 CUCHARA MESA XL table spoon xl vintage, cuillère table xl vintage, cucchiaio tavola xl vintage, tafellöffel xl vintage	4,93 €	0/12/120/2880/5760	60	190	3
C 7287 TENEDOR MESA 3 PUAS XL table fork 3 prongs xl vintage, fourchette table xl 3 dents vintage, forchetta tavola xl 3 punte vintage, tafelgabel xl vintage	4,93 €	0/12/120/2880/5760	60	195	3
D 7081 CUCHILLO MESA vintage table knife, couteau table vintage, coltello tavola vintage, tafelmesser vintage	5,21 €	0/12/120/1800/9000	60	183	
E 7082 CUCHARA MESA vintage table spoon, cuillère table vintage, cucchiaio tavola vintage, tafellöffel vintage	4,24 €	0/12/120/1800/9000	60	170	2,5
F 7083 TENEDOR MESA 2 PUAS vintage table fork 2 prongs, fourchette table 2 dents vintage, forchetta tavola 2 punte, tafelgabel 2	4,24 €	0/12/120/1800/9000	60	179	2,5
G 7084 TENEDOR MESA 3 PUAS vintage table fork 3 prongs, fourchette table 3 dents vintage, forchetta tavola 3 punte, tafelgabel 3	4,24 €	0/12/120/1800/9000	60	163	2,5
H 7085 CUCHILLO MANTEQUILLA vintage butter knife, couteau beurre, coltello burro, buttermesser	4,91 €	0/12/120/1800/9000	60	155	
I 7086 CUCHILLO LUNCH vintage cake knife, couteau gâteau, coltello dolce, kuchenmesser	4,62 €	0/12/120/1800/9000	60	133	
J 7087 TENEDOR LUNCH vintage cake fork, fourchette gâteau, forchetta dolce, kuchengabel	3,66 €	0/12/120/1800/9000	60	138	2
K 7088 CUCHARA CAFÉ vintage coffee spoon, cuillère café, cucchiaio caffè, kaffeelöffel	3,66 €	0/12/120/1800/9000	60	115,4	1,7
L 7089 CUCHARA SIDE vintage side spoon, cuillère side, cucchiaio side, löffel side	4,35 €	0/12/120/1800/9000	60	93,5	2
M 7090 CUCHARA MOKA vintage moka spoon, cuillère moka, cucchiaio moka, makkalöffel	3,95 €	0/12/120/1800/9000	60	97,5	1,7
N 7091 CUCHARA ARROZ vintage rice spoon, cuillère à riz, cucchiaio riso, reislöffel	6,56 €	0/12/120/1680/6720	60	90	2,5
O 7092 TENEDOR RASTRILLO vintage wide fork, fourchette râteau, forchetta wide, tafelgabel wide	6,56 €	0/12/120/1680/6720	60	113	2,5
9794 16 PIEZAS 16 pieces, écrin 16 pièces, bauletto 16 pz., 16 stück	69,59 €	1/0/2/5/50	2		3
9793 24 PIEZAS 24 pieces, écrin 24 pièces, bauletto 24 pz., 24 stück	100,96 €	1/0/2/5/50	2		3
8706 30 PIEZAS 30 pieces, écrin 30 pièces, bauletto 30 pz., 30 stück	122,75 €	1/0/2/5/50	2		3



Kodai Vintage Black

INOX 18% Nickel Free / 3mm / Vintage Black

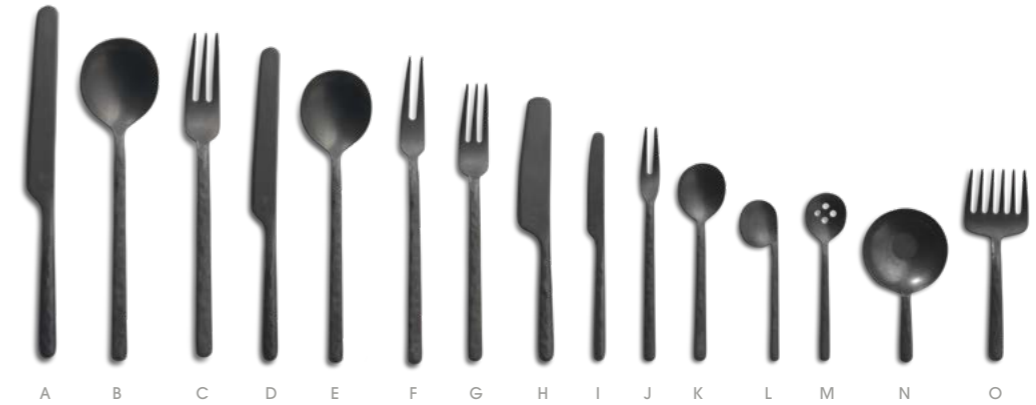

	€	UE	MOQ	▶ mm	✂ mm
A 7277 CUCHILLO MESA XL table knife xl vintage, couteau table xl vintage, coltello tavola xl vintage, tafelmesser xl vintage	5,92 €	0/12/120/2880/5760	60	212	
B 7280 CUCHARA MESA XL table spoon xl vintage, cuillère table xl vintage, cucchiaio tavola xl vintage, tafellöffel xl vintage	4,93 €	0/12/120/2880/5760	60	190	3
C 7286 TENEDOR MESA 3 PUAS XL table fork 3 prongs xl vintage, fourchette table xl 3 dents vintage, forchetta tavola xl 3 punte vintage, tafelgabel xl vintage	4,93 €	0/12/120/2880/5760	60	195	3
D 7069 CUCHILLO MESA vintage table knife, couteau table vintage, coltello tavola vintage, tafelmesser vintage	5,21 €	0/12/120/1800/9000	60	183	
E 7070 CUCHARA MESA vintage table spoon, cuillère table vintage, cucchiaio tavola vintage, tafellöffel vintage	4,24 €	0/12/120/1800/9000	60	170	2,5
F 7071 TENEDOR MESA 2 PUAS vintage table fork 2 prongs, fourchette table 2 dents vintage, forchetta tavola 2 punte, tafelgabel 2	4,24 €	0/12/120/1800/9000	60	179	2,5
G 7072 TENEDOR MESA 3 PUAS vintage table fork 3 prongs, fourchette table 3 dents vintage, forchetta tavola 3 punte, tafelgabel 3	4,24 €	0/12/120/1800/9000	60	163	2,5
H 7073 CUCHILLO MANTEQUILLA vintage butter knife, couteau beurre, coltello burro, buttermesser	4,91 €	0/12/120/1800/9000	60	155	
I 7074 CUCHILLO LUNCH vintage cake knife, couteau gâteau, coltello dolce, kuchenmesser	4,62 €	0/12/120/1800/9000	60	133	
J 7075 TENEDOR LUNCH vintage cake fork, fourchette gâteau, forchetta dolce, kuchengabel	3,66 €	0/12/120/1800/9000	60	138	2
K 7076 CUCHARA CAFÉ vintage coffee spoon, cuillère café, cucchiaio caffè, kaffeelöffel	3,66 €	0/12/120/1800/9000	60	115,4	1,7
L 7077 CUCHARA SIDE vintage side spoon, cuillère side, cucchiaio side, löffel side	4,35 €	0/12/120/1800/9000	60	93,5	2
M 7078 CUCHARA MOKA vintage moka spoon, cuillère moka, cucchiaio moka, makkalöffel	3,95 €	0/12/120/1800/9000	60	97,5	1,7
N 7079 CUCHARA ARROZ vintage rice spoon, cuillère à riz, cucchiaio riso, reislöffel	6,58 €	0/12/120/1680/6720	60	90	2,5
O 7080 TENEDOR RASTRILLO vintage wide fork, fourchette râteau, forchetta wide, tafelgabel wide	6,56 €	0/12/120/1680/6720	60	113	2,5
9796 16 PIEZAS 16 pieces, écrin 16 pièces, bauletto 16 pz., 16 stück	69,94 €	1/0/2/5/50	2		3
9795 24 PIEZAS 24 pieces, écrin 24 pièces, bauletto 24 pz., 24 stück	101,46 €	1/0/2/5/50	2		3
8707 30 PIEZAS 30 pieces, écrin 30 pièces, bauletto 30 pz., 30 stück	122,75 €	1/0/2/5/50	2		3





Mini Kodai

Mini Kodai 
Servicio mesa / Table top



Gama de miniaturas pensada en combinar la colección Kodai de Culter para crear el conjunto perfecto en la mesa y disfrutar de una experiencia completa al degustar un aperitivo o unas tapas.

Miniatures range designed to combine Culter Kodai collection and create a perfect set on a table and enjoy a complete experience on tasting a snack or "tapas".



Porcelana / Porcelain



La calidad del proceso de fabricación de esta porcelana, cocida en 2 tiempos a más de 1.200°C, ofrece al material resistencia, suavidad al tacto e impermeabilidad de la superficie.

With two firings at 1200°C, our porcelain can withstand the demands of the most intense service. Microwavable and oven and dishwasher safe.

Textura
Texture

La sutil textura del mango de los cubiertos se reproduce en determinadas partes de esta colección de miniaturas de porcelana de alta calidad.

The cutlery handle subtle texture is reproduced in certain parts of this high quality miniatures porcelain collection.

Presentaciones únicas
Unique presentations

Los tamaños de las piezas son proporcionales a las dimensiones de la colección Kodai, lo que crea una interesante interacción entre todos los elementos.

The size of the pieces are proportional to the Kodai collection dimensions, what creates an interesting interaction between all elements.



**Mini caja S**

Mini box S
Boîte porcelaine S
Cassetta di porcellana S
Porzellan behälter S



REF.	W _(mm)	L _(mm)	H _(mm)	€	UE / MOQ
7622	60	60	55	5,75	1-6-144-0-0 / 6

Mini caja M

Mini box M
Boîte porcelaine M
Cassetta di porcellana M
Porzellan behälter M



REF.	W _(mm)	L _(mm)	H _(mm)	€	UE / MOQ
7621	80	120	70	8,62	1-6-36-0-0 / 6

Mini colador

Mini colander
Tamis de porcelaine
Colino di porcellana
Porzellan einsatz



REF.	Ø _(mm)	H _(mm)	€	UE / MOQ
7623	100	60	7,47	1-6-72-0-0 / 6

Mini parrilla

Mini grill plate
Mini grill de porcelaine
Mini graticola di porcellana
Porzellan gratin platte



REF.	Ø _(mm)	L _(mm)	H _(mm)	€	UE / MOQ
7624	90	125	20	5,75	1-6-144-0-0 / 6

**Mini Kodai**

Servicio mesa / Table Top

**Mini vaso**

Mini cup
Mini verre
Mini vaso
Dipschälchen klein



REF.	Ø _(mm)	H _(mm)	ml	€	UE / MOQ
7625	50	40	2,5	2,16	1-6-144-0-0 / 6

Mini tarrina

Mini ramekin
Mini pôt
Mini terrina
Dipschälchen groß



REF.	Ø _(mm)	H _(mm)	€	UE / MOQ
7626	80	25	2,87	1-6-144-0-0 / 6

Mini sartén

Mini pan
Mini poêle
Mini padella
mini pfanne



REF.	Ø _(mm)	L _(mm)	H _(mm)	€	UE / MOQ
7627	90	140	25	7,18	1-6-72-0-0 / 6

Mini cazuela

Mini gratin plate
Mini cocotte
Mini casseruola
Mini gratin platte



REF.	Ø _(mm)	L _(mm)	H _(mm)	€	UE / MOQ
7628	90	130	20	5,75	1-6-72-0-0 / 6

Mini bandeja

Mini tray
Mini plateau
Mini vassoio
Mini platte



REF.	W _(mm)	L _(mm)	H _(mm)	€	UE / MOQ
7629	80	155	10	7,18	1-6-72-0-0 / 6

Mini olla

Mini soup tureen
Mini casserole
Mini pentola
Mini suppenterrine



REF.	Ø _(mm)	L _(mm)	H _(mm)	ml	€	UE / MOQ
7630	100	140	90	250	17,24	1-6-36-0-0 / 6



Fleur de Lys



INOX 18/10 / 4,5mm / Mirror

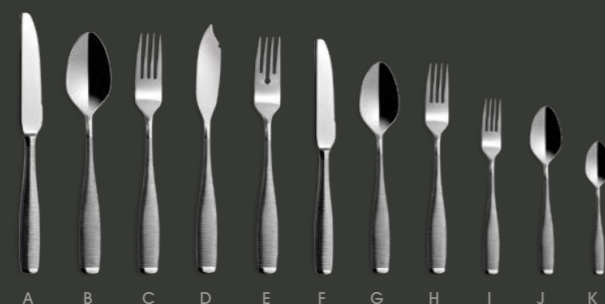

A B C D E F G H I J K

Fleur de Lys

INOX 18/10 / 4,5mm / Mirror



	€	UE	MOQ	▶ mm	✕ mm
A 7980 CUCHILLO MESA table knife, couteau table, coltello tavola, tafeimesser	5,07 €	0/12/120/1920/5760	60	235	
B 7981 CUCHARA MESA table spoon, cuillère table, cucchiaio tavola, tafelöffel	4,35 €	0/12/120/1440/7200	60	215	4,5
C 7982 Tenedor MESA table fork, fourchette table, forchetta tavola, tafelgabel	4,35 €	0/12/120/1440/7200	60	214	4,5
D 8007 PALA PESCADO fish knife, couteau poisson, coltello pesce, fischmesser	4,35 €	0/12/120/1440/7200	60	221	4,5
E 8008 Tenedor PESCADO fish fork, fourchette poisson, forchetta pesce, fischgabel	4,35 €	0/12/120/1440/7200	60	210	4,5
F 7983 CUCHILLO POSTRE dessert knife, couteau dessert, coltello frutta, dessertmesser	4,22 €	0/12/120/1920/5760	60	208	
G 7984 CUCHARA POSTRE dessert spoon, cuillère dessert, cucchiaio frutta, dessertlöffel	3,65 €	0/12/120/1440/7200	60	189	4
H 7985 Tenedor POSTRE dessert fork, fourchette dessert, forchetta frutta, dessertgabel	3,65 €	0/12/120/1440/7200	60	186	4
I 7986 Tenedor LUNCH cake fork, fourchette gâteau, forchetta dolce, kuchengabel	2,42 €	0/12/120/2520/15120	60	156	3
J 7987 CUCHARA CAFÉ tea spoon, cuillère café, cucchiaio caffè, kaffeelöffel	2,42 €	0/12/120/2520/15120	60	150	3
K 7988 CUCHARA MOKA coffee/moka spoon, cuillère moka, cucchiaio moka, mokkalöffel	2,02 €	0/12/120/2520/15120	60	118	2,5
9788 16 PIEZAS 16 pieces, écrin 16 pièces, bauletto 16 pz., 16 stück	81,11 €	1/0/2/5/50	2		4,5
7989 24 PIEZAS 24 pieces, écrin 24 pièces, bauletto 24 pz., 24 stück	121,66 €	1/0/2/5/50	2		4,5
8703 30 PIEZAS 30 pieces, écrin 30 pièces, bauletto 30 pz., 30 stück	136,00 €	1/0/2/5/50	2		4,5





Fleur de Lys Vintage Black



INOX 18/10 / 4,5mm / Vintage Black



A B C D E F G H I J K

Fleur de Lys Vintage Black

INOX 18/10 / 4,5mm / Vintage Black



	€	UE	MOQ	▶ mm	✕ mm
A 6962 CUCHILLO MESA table knife, couteau table, coltello tavola, tafelmesser	8,29 €	0/12/120/1920/5760	60	235	
B 6963 CUCHARA MESA table spoon, cuillère table, cucchiaio tavola, tafellöffel	8,38 €	0/12/120/1440/7200	60	215	4,5
C 6964 Tenedor MESA table fork, fourchette table, forchetta tavola, tafelgabel	8,38 €	0/12/120/1440/7200	60	214	4,5
D 6965 PALA PESCADO fish knife, couteau poisson, coltello pesce, fischmesser	8,38 €	0/12/120/1440/7200	60	221	4,5
E 6966 Tenedor PESCADO fish fork, fourchette poisson, forchetta pesce, fischgabel	8,38 €	0/12/120/1440/7200	60	210	4,5
F 6967 CUCHILLO POSTRE dessert knife, couteau dessert, coltello frutta, dessertmesser	7,84 €	0/12/120/1920/5760	60	208	
G 6968 CUCHARA POSTRE dessert spoon, cuillère dessert, cucchiaio frutta, dessertlöffel	7,61 €	0/12/120/1440/7200	60	189	4
H 6969 Tenedor POSTRE dessert fork, fourchette dessert, forchetta frutta, dessertgabel	7,61 €	0/12/120/1440/7200	60	186	4
I 6970 Tenedor LUNCH cake fork, fourchette gâteau, forchetta dolce, kuchengabel	6,09 €	0/12/120/2520/15120	60	156	3
J 6971 CUCHARA CAFÉ tea spoon, cuillère café, cucchiaio caffè, kaffeelöffel	6,09 €	0/12/120/2520/15120	60	150	3
K 6972 CUCHARA MOKA coffee/moka spoon, cuillère moka, cucchiaio moka, mokkalöffel	5,64 €	0/12/120/2520/15120	60	118	2,5
9787 16 PIEZAS 16 pieces, écrin 16 pièces, bauletto 16 pz., 16 stück	142,82 €	1/0/2/5/50	2		4,5
6973 24 PIEZAS 24 pieces, écrin 24 pièces, bauletto 24 pz., 24 stück	214,29 €	1/0/2/5/50	2		4,5
8702 30 PIEZAS 30 pieces, écrin 30 pièces, bauletto 30 pz., 30 stück	250,77 €	1/0/2/5/50	2		4,5





Baobab



INOX 18/10 / 11mm / Mirror

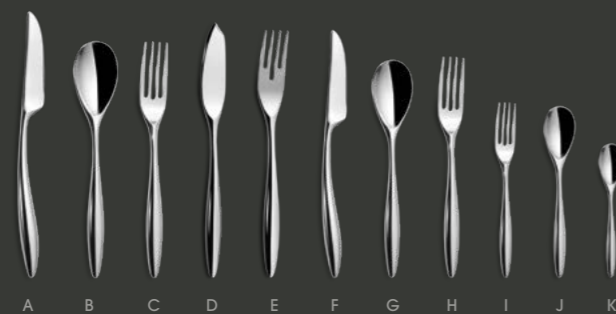

Baobab

INOX 18/10 / 11mm / Mirror



	€	UE	MOQ	▶ mm	✕ mm
A 6423 CUCHILLO MESA table knife, couteau table, coltello tavola, tafelmesser	9,76 €	0/12/120/1920/5760	60	226	
B 6424 CUCCHARA MESA table spoon, cuillère table, cucchiaio tavola, tafellöffel	9,76 €	0/12/120/1440/7200	60	200	11
C 6425 TENEDOR MESA table fork, fourchette table, forchetta tavola, tafelgabel	9,76 €	0/12/120/1440/7200	60	200	11
D 6426 PALA PESCADO fish knife, couteau poisson, coltello pesce, fischmesser	10,53 €	0/12/120/1440/7200	60	216	11
E 6427 TENEDOR PESCADO fish fork, fourchette poisson, forchetta pesce, fischgabel	10,53 €	0/12/120/1440/7200	60	210	11
F 6428 CUCHILLO POSTRE dessert knife, couteau dessert, coltello frutta, dessertmesser	9,34 €	0/12/120/1920/5760	60	210	
G 6429 CUCCHARA POSTRE dessert spoon, cuillère dessert, cucchiaio frutta, dessertlöffel	9,34 €	0/12/120/1440/7200	60	185	10,5
H 6430 TENEDOR POSTRE dessert fork, fourchette dessert, forchetta frutta, dessertgabel	9,34 €	0/12/120/1440/7200	60	187	10,5
I 6431 TENEDOR LUNCH cake fork, fourchette gâteau, forchetta dolce, kuchengabel	5,80 €	0/12/120/2520/15120	60	148	8,5
J 6432 CUCCHARA CAFÉ tea spoon, cuillère café, cucchiaio caffè, kaffeelöffel	5,49 €	0/12/120/2520/15120	60	145	8
K 6433 CUCCHARA MOKA coffee/moka spoon, cuillère moka, cucchiaio moka, mokkalöffel	4,15 €	0/12/120/2520/15120	60	113	6,5
9781 16 PIEZAS 16 pieces, écrin 16 pièces, bauletto 16 pz., 16 stück	152,53 €	1/0/2/5/50	2		11
6472 24 PIEZAS 24 pieces, écrin 24 pièces, bauletto 24 pz., 24 stück	231,90 €	1/0/2/5/50	2		115
8696 30 PIEZAS 30 pieces, écrin 30 pièces, bauletto 30 pz., 30 stück	261,64 €	1/0/2/5/50	2		11





Aster



INOX 18/10 / 9mm / Mirror

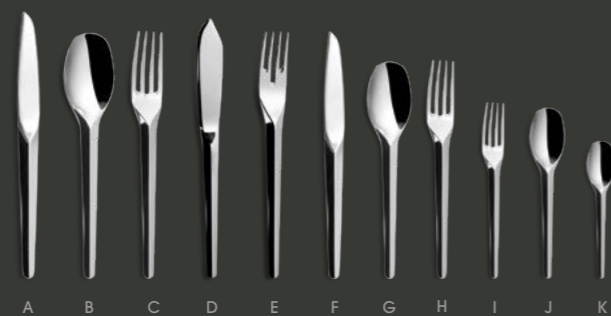

Aster

INOX 18/10 / 9mm / Mirror



	€	UE	MOQ	▶ mm	✕ mm
A 6412 CUCHILLO MESA table knife, couteau table, coltello tavola, tafelmesser	9,03 €	0/12/120/1920/5760	60	227	
B 6413 CUCHARA MESA table spoon, cuillère table, cucchiaino tavola, tafellöffel	9,03 €	0/12/120/1440/7200	60	208	9
C 6414 TENEDOR MESA table fork, fourchette table, forchetta tavola, tafelgabel	9,03 €	0/12/120/1440/7200	60	210	9
D 6421 PALA PESCADO fish knife, couteau poisson, coltello pesce, fischmesser	8,97 €	0/12/120/1440/7200	60	220	8,5
E 6422 TENEDOR PESCADO fish fork, fourchette poisson, forchetta pesce, fischgabel	8,97 €	0/12/120/1440/7200	60	210	8,5
F 6415 CUCHILLO POSTRE dessert knife, couteau dessert, coltello frutta, dessertmesser	8,85 €	0/12/120/1920/5760	60	210	
G 6416 CUCHARA POSTRE dessert spoon, cuillère dessert, cucchiaino frutta, dessertlöffel	8,85 €	0/12/120/1440/7200	60	185	8
H 6417 TENEDOR POSTRE dessert fork, fourchette dessert, forchetta frutta, dessertgabel	8,85 €	0/12/120/1440/7200	60	185	8
I 6418 TENEDOR LUNCH cake fork, fourchette gâteau, forchetta dolce, kuchengabel	5,07 €	0/12/120/2520/15120	60	150	6,5
J 6419 CUCHARA CAFÉ tea spoon, cuillère café, cucchiaino caffè, kaffeelöffel	5,07 €	0/12/120/2520/15120	60	145	6,5
K 6420 CUCHARA MOKA coffee/moka spoon, cuillère moka, cucchiaino moka, mokkalöffel	3,97 €	0/12/120/2520/15120	60	117	5
9780 16 PIEZAS 16 pieces, écrin 16 pièces, bauletto 16 pz., 16 stück	142,36 €	1/0/2/5/50	2		9
6471 24 PIEZAS 24 pieces, écrin 24 pièces, bauletto 24 pz., 24 stück	213,59 €	1/0/2/5/50	2		9
8695 30 PIEZAS 30 pieces, écrin 30 pièces, bauletto 30 pz., 30 stück	243,68 €	1/0/2/5/50	2		9



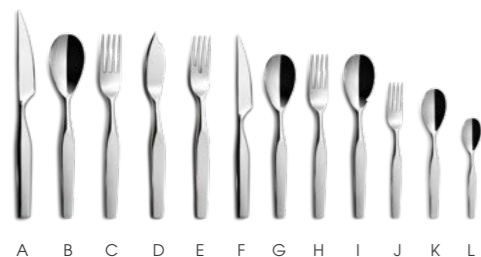

A	6473	CUCHILLO MESA table knife, couteau table, coltello tavola, tafelmesser	7,81 €	0/12/120/1920/5760	60	235	
B	6474	CUCHARA MESA table spoon, cuillère table, cucchiaio tavola, tafellöffel	7,81 €	0/12/120/1440/7200	60	210	6
C	6475	TENEDOR MESA table fork, fourchette table, forchetta tavola, tafelgabel	7,81 €	0/12/120/1440/7200	60	210	6
D	6476	PALA PESCADO fish knife, couteau poisson, coltello pesce, fischmesser	7,81 €	0/12/120/1440/7200	60	212	6
E	6477	TENEDOR PESCADO fish fork, fourchette poisson, forchetta pesce, fischgabel	7,81 €	0/12/120/1440/7200	60	207	6
F	6478	CUCHILLO POSTRE dessert knife, couteau dessert, coltello frutta, dessertmesser	6,59 €	0/12/120/1920/5760	60	209	
G	6479	CUCHARA POSTRE dessert spoon, cuillère dessert, cucchiaio frutta, dessertlöffel	6,59 €	0/12/120/1440/7200	60	187	5
H	6480	TENEDOR POSTRE dessert fork, fourchette dessert, forchetta frutta, dessertgabel	6,59 €	0/12/120/1440/7200	60	188	5
I	6524	CUCHARA SALSA sauce spoon, cuillère à sauce, cucchiaio salsa, so_enlöffel	7,81 €	0/12/120/1440/7200	60	187	5
J	6481	TENEDOR LUNCH cake fork, fourchette gâteau, forchetta dolce, kuchengabel	4,58 €	0/12/120/2520/15120	60	154	4
K	6482	CUCHARA CAFÉ tea spoon, cuillère café, cucchiaio caffè, kaffeelöffel	4,58 €	0/12/120/2520/15120	60	147	4
L	6483	CUCHARA MOKA coffee/moka spoon, cuillère moka, cucchiaio moka, mokkalöffel	3,97 €	0/12/120/2520/15120	60	114	4
	9782	16 PIEZAS 16 pieces, écrin 16 pièces, bauletto 16 pz., 16 Stück	126,09 €	1/0/2/5/50	2	6	
	6484	24 PIEZAS 24 pieces, écrin 24 pièces, bauletto 24 pz., 24 Stück	189,18 €	1/0/2/5/50	2	6	
	8697	30 PIEZAS 30 pieces, écrin 30 pièces, bauletto 30 pz., 30 Stück	216,33 €	1/0/2/5/50	2	6	

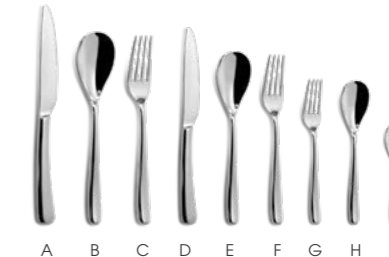

A	7057	CUCHILLO MESA table knife, couteau table, coltello tavola, tafelmesser	6,53 €	0/12/120/1920/5760	60	234	
B	7058	CUCHARA MESA table spoon, cuillère table, cucchiaio tavola, tafellöffel	6,82 €	0/12/120/1440/7200	60	205	8,5
C	7059	TENEDOR MESA table fork, fourchette table, forchetta tavola, tafelgabel	6,82 €	0/12/120/1440/7200	60	204	8,5
D	7060	CUCHILLO POSTRE dessert knife, couteau dessert, coltello frutta, dessertmesser	6,41 €	0/12/120/1920/5760	60	210	
E	7061	CUCHARA POSTRE dessert spoon, cuillère dessert, cucchiaio frutta, dessertlöffel	6,58 €	0/12/120/1440/7200	60	182	7,5
F	7062	TENEDOR POSTRE dessert fork, fourchette dessert, forchetta frutta, dessertgabel	6,63 €	0/12/120/1440/7200	60	181	7,5
G	7063	TENEDOR LUNCH cake fork, fourchette gâteau, forchetta dolce, kuchengabel	4,61 €	0/12/120/2520/15120	60	156	6,4
H	7064	CUCHARA CAFÉ/TE tea spoon, cuillère café, cucchiaio caffè, kaffeelöffel	4,61 €	0/12/120/2520/15120	60	154	6,4
I	7065	CUCHARA MOKA coffee/moka spoon, cuillère moka, cucchiaio moka, mokkalöffel	4,45 €	0/12/120/2520/15120	60	108	4,5
	9777	16 PIEZAS 16 pieces, écrin 16 pièces, bauletto 16 pz., 16 Stück	113,56 €	1/0/2/5/50	2	6	8,5
	5963	24 PIEZAS 24 pieces, écrin 24 pièces, bauletto 24 pz., 24 Stück	173,32 €	1/0/2/5/50	2	6	8,5
	8692	30 PIEZAS 30 pieces, écrin 30 pièces, bauletto 30 pz., 30 Stück	200,62 €	1/0/2/5/50	2	6	8,5





Oak



INOX 18/10 / 4mm / Mirror

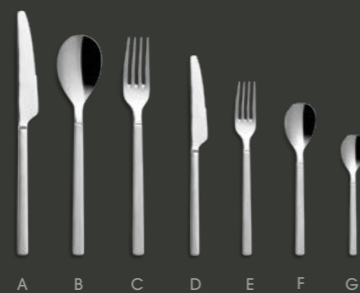

A B C D E F G

Oak

INOX 18/10 / 4mm / Mirror



	€	UE	MOQ	▶ mm	✂ mm
A 5898 CUCHILLO MESA table knife, couteau table, coltello tavola, tafelmesser	3,48 €	0/12/120/1920/5760	60	225	9
B 5899 CUCHARA MESA table spoon, cuillère table, cucchiaio tavola, tafellöffel	3,57 €	0/12/120/1440/7200	60	200	4
C 5900 Tenedor MESA table fork, fourchette table, forchetta tavola, tafelgabel	3,57 €	0/12/120/1440/7200	60	200	4
D 5895 CUCHILLO LUNCH cake knife, couteau gâteau, coltello dolce, kuchenmesser	2,76 €	0/12/120/1920/5760	60	184	7
E 5894 Tenedor LUNCH cake fork, fourchette gâteau, forchetta dolce, kuchengabel	2,76 €	0/12/120/2520/15120	60	160	3,5
F 5893 CUCHARA CAFÉ tea spoon, cuillère café, cucchiaio caffè, kaffeelöffel	2,73 €	0/12/120/2520/15120	60	140	3,5
G 5902 CUCHARA MOKA coffee/moka spoon, cuillère moka, cucchiaio moka, mokkalöffel	1,94 €	0/12/120/2520/15120	60	112	3
9798 16 PIEZAS 16 pieces, écrin 16 pièces, bauletto 16 pz., 16 stück	54,59 €	1/0/2/5/50	2		3
9797 24 PIEZAS 24 pieces, écrin 24 pièces, bauletto 24 pz., 24 stück	78,59 €	1/0/2/5/50	2		3
8708 30 PIEZAS 30 pieces, écrin 30 pièces, bauletto 30 pz., 30 stück	92,20 €	1/0/2/5/50	2		3





	€	UE	MOQ	▶ mm	✕ mm
A 3619 CUCHILLO CHULETERO steak knife, couteau steak, coltello bistecca, steakmesser	3,15 €	0/12/120/1920/5760	60	220	
B 5474 CUCHILLO MESA table knife, couteau table, coltello tavola, tafelmesser	3,15 €	0/12/120/1920/5760	60	235	
C 5475 CUCHARA MESA table spoon, cuillère table, cucchiaino tavola, tafellöffel	5,14 €	0/12/120/1440/7200	60	208	7
D 5476 TENEDOR MESA table fork, fourchette table, forchetta tavola, tafelgabel	5,14 €	0/12/120/1440/7200	60	208	7
E 5483 PALA PESCADO fish knife, couteau poisson, coltello pesce, fischmesser	4,32 €	0/12/120/1440/7200	60	200	6
F 5484 TENEDOR PESCADO fish fork, fourchette poisson, forchetta pesce, fischgabel	4,32 €	0/12/120/1440/7200	60	185	6
G 2171 CUCHILLO POSTRE dessert knife, couteau dessert, coltello frutta, dessertmesser	2,88 €	0/12/120/1920/5760	60	205	
H 5485 CUCHARA POSTRE dessert spoon, cuillère dessert, cucchiaino frutta, dessertlöffel	4,04 €	0/12/120/1440/7200	60	170	6
I 5486 TENEDOR POSTRE dessert fork, fourchette dessert, forchetta frutta, dessertgabel	4,04 €	0/12/120/1440/7200	60	170	6
J 5478 TENEDOR LUNCH cake fork, fourchette gâteau, forchetta dolce, kuchengabel	3,51 €	0/12/120/2520/15120	60	148	5,5
K 5477 CUCHARA CAFÉ tea spoon, cuillère café, cucchiaino caffè, kaffeelöffel	3,51 €	0/12/120/2520/15120	60	145	5,5
L 5479 CUCHARA MOKA coffee/moka spoon, cuillère moka, cucchiaino moka, mokkalöffel	2,84 €	0/12/120/2520/15120	60	120	4,5
9801 16 PIEZAS 16 pieces, écin 16 pièces, bauletto 16 pz., 16 stück	69,05 €	1/0/4/56/112	4	7	
1600 24 PIEZAS 24 pieces, écin 24 pièces, bauletto 24 pz., 24 stück	103,59 €	1/0/4/56/112	4	7	
8711 30 PIEZAS 30 pieces, écin 30 pièces, bauletto 30 pz., 30 stück	122,67 €	1/0/4/56/112	4	7	

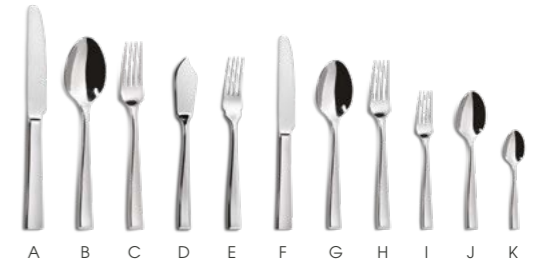

	€	UE	MOQ	▶ mm	✕ mm
A 7022 CUCHILLO MESA table knife, couteau table, coltello tavola, tafelmesser	5,07 €	0/12/120/1920/5760	60	243	8
B 7023 CUCHARA MESA table spoon, cuillère table, cucchiaino tavola, tafellöffel	4,80 €	0/12/120/1440/7200	60	209	6
C 7024 TENEDOR MESA table fork, fourchette table, forchetta tavola, tafelgabel	4,80 €	0/12/120/1440/7200	60	209	6
D 7025 PALA PESCADO fish knife, couteau poisson, coltello pesce, fischmesser	4,71 €	0/12/120/1440/7200	60	188	5
E 7026 TENEDOR PESCADO fish fork, fourchette poisson, forchetta pesce, fischgabel	4,66 €	0/12/120/1440/7200	60	188	5
F 7027 CUCHILLO POSTRE dessert knife, couteau dessert, coltello frutta, dessertmesser	4,38 €	0/12/120/1920/5760	60	210	7
G 7028 CUCHARA POSTRE dessert spoon, cuillère dessert, cucchiaino frutta, dessertlöffel	4,66 €	0/12/120/1440/7200	60	184	5
H 7029 TENEDOR POSTRE dessert fork, fourchette dessert, forchetta frutta, dessertgabel	4,66 €	0/12/120/1440/7200	60	184	5
I 7030 TENEDOR LUNCH cake fork, fourchette gâteau, forchetta dolce, kuchengabel	3,05 €	0/12/120/2520/15120	60	151	4,5
J 7031 CUCHARA CAFÉ tea spoon, cuillère café, cucchiaino caffè, kaffeelöffel	3,05 €	0/12/120/2520/15120	60	151	4,5
K 7032 CUCHARA MOKA coffee/moka spoon, cuillère moka, cucchiaino moka, mokkalöffel	2,75 €	0/12/120/2520/15120	60	108	4
9779 16 PIEZAS 16 pieces, écin 16 pièces, bauletto 16 pz., 16 stück	77,33 €	1/0/2/5/50	2	6	
5965 24 PIEZAS 24 pieces, écin 24 pièces, bauletto 24 pz., 24 stück	115,95 €	1/0/2/5/50	2	6	
8694 30 PIEZAS 30 pieces, écin 30 pièces, bauletto 30 pz., 30 stück	134,21 €	1/0/2/5/50	2	6	



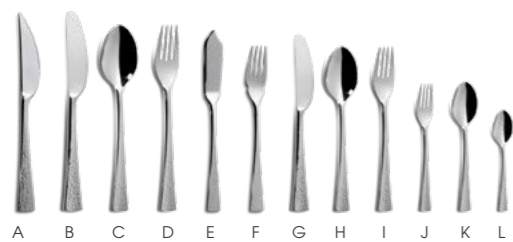

	€	UE	MOQ	✂ mm	✂ mm
A 7010 CUCHILLO CHULETERO steak knife, couteau steak, coltello bistecca, steakmesser	5,05 €	0/12/120/1920/5760	60	225	7
B 7011 CUCHILLO MESA table knife, couteau table, coltello tavola, tafelmesser	4,85 €	0/12/120/1920/5760	60	225	7
C 7012 CUCHARA MESA table spoon, cuillère table, cucchiaino tavola, tafellöffel	3,84 €	0/12/120/1440/7200	60	215	3,5
D 7013 TENEDOR MESA table fork, fourchette table, forchetta tavola, tafelgabel	3,84 €	0/12/120/1440/7200	60	212	3,5
E 7014 PALA PESCADO fish knife, couteau poisson, coltello pesce, fischmesser	3,60 €	0/12/120/1440/7200	60	205	3
F 7015 TENEDOR PESCADO fish fork, fourchette poisson, forchetta pesce, fischgabel	3,60 €	0/12/120/1440/7200	60	188	3
G 7016 CUCHILLO POSTRE dessert knife, couteau dessert, coltello frutta, dessertmesser	4,28 €	0/12/120/1920/5760	60	203	6
H 7017 CUCHARA POSTRE dessert spoon, cuillère dessert, cucchiaino frutta, dessertlöffel	3,05 €	0/12/120/1440/7200	60	185	3
I 7018 TENEDOR POSTRE dessert fork, fourchette dessert, forchetta frutta, dessertgabel	3,05 €	0/12/120/1440/7200	60	185	3
J 7019 TENEDOR LUNCH cake fork, fourchette gâteau, forchetta dolce, kuchengabel	2,44 €	0/12/120/2520/15120	60	145	2,5
K 7020 CUCHARA CAFÉ tea spoon, cuillère café, cucchiaino caffè, kaffeelöffel	2,44 €	0/12/120/2520/15120	60	147	2,5
L 7021 CUCHARA MOKA coffee/moka spoon, cuillère moka, cucchiaino moka, mokkalöffel	2,27 €	0/12/120/2520/15120	60	115	2
9778 16 PIEZAS 16 pieces, écriin 16 pièces, bauletto 16 pz., 16 stück	73,27 €	1/0/2/5/50	2		3,5
5964 24 PIEZAS 24 pieces, écriin 24 pièces, bauletto 24 pz., 24 stück	109,85 €	1/0/2/5/50	2		3,5
8693 30 PIEZAS 30 pieces, écriin 30 pièces, bauletto 30 pz., 30 stück	124,53 €	1/0/2/5/50	2		3,5



	€	UE	MOQ	✂ mm	✂ mm
A 6895 CUCHILLO MESA table knife, couteau table, coltello tavola, tafelmesser	5,20 €	0/12/120/1920/5760	60	255	
B 6896 CUCHARA MESA table spoon, cuillère table, cucchiaino tavola, tafellöffel	4,16 €	0/12/120/1440/7200	60	209	3,5
C 6897 TENEDOR MESA table fork, fourchette table, forchetta tavola, tafelgabel	4,16 €	0/12/120/1440/7200	60	209	3,5
D 6898 PALA PESCADO fish knife, couteau poisson, coltello pesce, fischmesser	3,50 €	0/12/120/1440/7200	60	208	3
E 6899 TENEDOR PESCADO fish fork, fourchette poisson, forchetta pesce, fischgabel	3,50 €	0/12/120/1440/7200	60	190	3
F 6900 CUCHILLO POSTRE dessert knife, couteau dessert, coltello frutta, dessertmesser	4,12 €	0/12/120/1920/5760	60	232	
G 6901 CUCHARA POSTRE dessert spoon, cuillère dessert, cucchiaino frutta, dessertlöffel	3,50 €	0/12/120/1440/7200	60	190	3
H 6902 TENEDOR POSTRE dessert fork, fourchette dessert, forchetta frutta, dessertgabel	3,50 €	0/12/120/1440/7200	60	190	3
I 6903 TENEDOR LUNCH cake fork, fourchette gâteau, forchetta dolce, kuchengabel	2,71 €	0/12/120/2520/15120	60	170	3
J 6904 CUCHARA CAFÉ tea spoon, cuillère café, cucchiaino caffè, kaffeelöffel	2,71 €	0/12/120/2520/15120	60	142	3
K 6905 CUCHARA MOKA coffee/moka spoon, cuillère moka, cucchiaino moka, mokkalöffel	2,38 €	0/12/120/2520/15120	60	111	2
9785 16 PIEZAS 16 pieces, écriin 16 pièces, bauletto 16 pz., 16 stück	79,38 €	1/0/2/5/50	2		3,5
6906 24 PIEZAS 24 pieces, écriin 24 pièces, bauletto 24 pz., 24 stück	119,13 €	1/0/2/5/50	2		3,5
8700 30 PIEZAS 30 pieces, écriin 30 pièces, bauletto 30 pz., 30 stück	135,35 €	1/0/2/5/50	2		3,5



Sangiovese Gold

INOX 18/10 / 3,5mm / Mirror

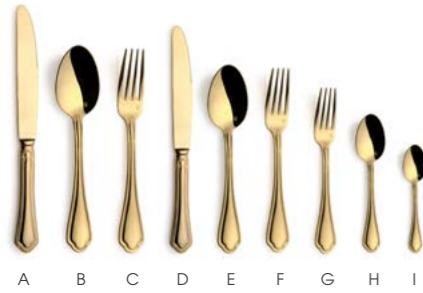

NEW



	€	UE	MOQ	✂ mm	✂ mm
A 7271 CUCHILLO MESA table knife, couteau table, coltello tavola, tafelmesser	7,51 €	0/12/120/1920/5760	60	255	
B 7418 CUCHARA MESA table spoon, cuillère table, cucchiaio tavola, tafellöffel	5,83 €	0/12/120/1440/7200	60	209	3,5
C 7272 TENEDOR MESA table fork, fourchette table, forchetta tavola, tafelgabel	5,83 €	0/12/120/1440/7200	60	209	3,5
D 7420 CUCHILLO POSTRE dessert knife, couteau dessert, coltello frutta, dessertmesser	5,92 €	0/12/120/1920/5760	60	232	
E 7419 CUCHARA POSTRE dessert spoon, cuillère dessert, cucchiaio frutta, dessertlöffel	4,78 €	0/12/120/1440/7200	60	190	3
F 7273 TENEDOR POSTRE dessert fork, fourchette dessert, forchetta frutta, dessertgabel	4,78 €	0/12/120/1440/7200	60	190	3
G 7957 TENEDOR LUNCH cake fork, fourchette gâteau, forchetta dolce, kuchengabel	4,12 €	0/12/120/2520/15120	60	170	3
H 7274 CUCHARA CAFÉ tea spoon, cuillère café, cucchiaio caffè, kaffeelöffel	3,85 €	0/12/120/2520/15120	60	142	3
I 7275 CUCHARA MOKA coffee/moka spoon, cuillère moka, cucchiaio moka, mokkalöffel	3,03 €	0/12/120/2520/15120	60	111	2
5555 16 PIEZAS 16 pieces, écriin 16 pièces, bauletto 16 pz., 16 Stück	96,98 €	1/0/4/56/112	2		3,5
5554 24 PIEZAS 24 pieces, écriin 24 pièces, bauletto 24 pz., 24 Stück	161,56 €	1/0/2/5/50	2		3,5
5556 30 PIEZAS 30 pieces, écriin 30 pièces, bauletto 30 pz., 30 Stück	166,68 €	1/0/4/56/112	2		3,5



Sangiovese Vintage Copper

INOX 18/10 / 3,5mm / Vintage



	€	UE	MOQ	✂ mm	✂ mm
A 5763 CUCHILLO MESA table knife, couteau table, coltello tavola, tafelmesser	8,32 €	0/12/120/1920/5760	60	255	
B 5764 CUCHARA MESA table spoon, cuillère table, cucchiaio tavola, tafellöffel	6,65 €	0/12/120/1440/7200	60	209	3,5
C 7737 TENEDOR MESA table fork, fourchette table, forchetta tavola, tafelgabel	6,65 €	0/12/120/1440/7200	60	209	3,5
D 5765 CUCHILLO POSTRE dessert knife, couteau dessert, coltello frutta, dessertmesser	6,74 €	0/12/120/1920/5760	60	232	
E 5766 CUCHARA POSTRE dessert spoon, cuillère dessert, cucchiaio frutta, dessertlöffel	5,60 €	0/12/120/1440/7200	60	190	3
F 5767 TENEDOR POSTRE dessert fork, fourchette dessert, forchetta frutta, dessertgabel	5,60 €	0/12/120/1440/7200	60	190	3
G 5768 TENEDOR LUNCH cake fork, fourchette gâteau, forchetta dolce, kuchengabel	4,94 €	0/12/120/2520/15120	60	170	3
H 5769 CUCHARA CAFÉ tea spoon, cuillère café, cucchiaio caffè, kaffeelöffel	4,94 €	0/12/120/2520/15120	60	142	3
I 5770 CUCHARA MOKA coffee/moka spoon, cuillère moka, cucchiaio moka, mokkalöffel	3,85 €	0/12/120/2520/15120	60	111	2
5558 16 PIEZAS 16 pieces, écriin 16 pièces, bauletto 16 pz., 16 Stück	110,61 €	1/0/4/56/112	2		3,5
5557 24 PIEZAS 24 pieces, écriin 24 pièces, bauletto 24 pz., 24 Stück	181,19 €	1/0/2/5/50	2		3,5
5559 30 PIEZAS 30 pieces, écriin 30 pièces, bauletto 30 pz., 30 Stück	193,39 €	1/0/4/56/112	2		3,5





Palma

Palma 

INOX 18/10 / 4mm / Mirror



INOX 18/10 / 4mm / Mirror

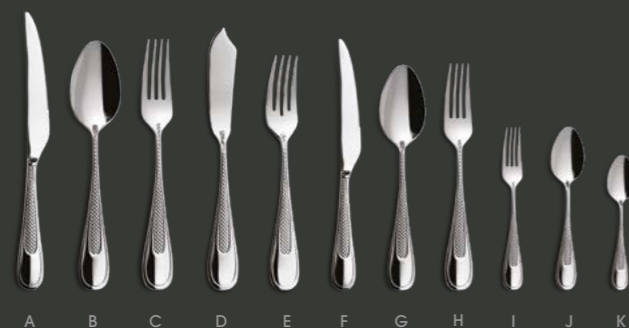

A B C D E F G H I J K



	€	UE	MOQ	✂ mm	✂ mm
A 6525 CUCHILLO MESA table knife, couteau table, coltello tavola, tafelmesser	4,44 €	0/12/120/1920/5760	60	238	
B 6526 CUCHARA MESA table spoon, cuillère table, cucchiaio tavola, tafellöffel	4,51 €	0/12/120/1440/7200	60	213	4
C 6527 TENEDOR MESA table fork, fourchette table, forchetta tavola, tafelgabel	4,51 €	0/12/120/1440/7200	60	213	4
D 6528 PALA PESCADO fish knife, couteau poisson, coltello pesce, fischmesser	4,51 €	0/12/120/1440/7200	60	224	4
E 6529 TENEDOR PESCADO fish fork, fourchette poisson, forchetta pesce, fischgabel	4,51 €	0/12/120/1440/7200	60	200	4
F 6530 CUCHILLO POSTRE dessert knife, couteau dessert, coltello frutta, dessertmesser	4,32 €	0/12/120/1920/5760	60	216	
G 6531 CUCHARA POSTRE dessert spoon, cuillère dessert, cucchiaio frutta, dessertlöffel	3,81 €	0/12/120/1440/7200	60	192	3,5
H 6532 TENEDOR POSTRE dessert fork, fourchette dessert, forchetta frutta, dessertgabel	3,81 €	0/12/120/1440/7200	60	192	3,5
I 6533 TENEDOR LUNCH cake fork, fourchette gâteau, forchetta dolce, kuchengabel	2,41 €	0/12/120/2520/15120	60	140	3
J 6534 CUCHARA CAFÉ tea spoon, cuillère café, cucchiaio caffè, kaffeelöffel	2,41 €	0/12/120/2520/15120	60	140	3
K 6535 CUCHARA MOKA coffee/moka spoon, cuillère moka, cucchiaio moka, mokkalöffel	2,10 €	0/12/120/2520/15120	60	115	2,5
9786 16 PIEZAS 16 pieces, écrin 16 pièces, bauletto 16 pz., 16 stück	83,24 €	1/0/2/5/50	2		4
6536 24 PIEZAS 24 pieces, écrin 24 pièces, bauletto 24 pz., 24 stück	124,89 €	1/0/2/5/50	2		4
8701 30 PIEZAS 30 pieces, écrin 30 pièces, bauletto 30 pz., 30 stück	139,00 €	1/0/2/5/50	2		4





Contour

Contour

INOX 18/10 / 4mm / Mirror



INOX 18/10 / 4mm / Mirror

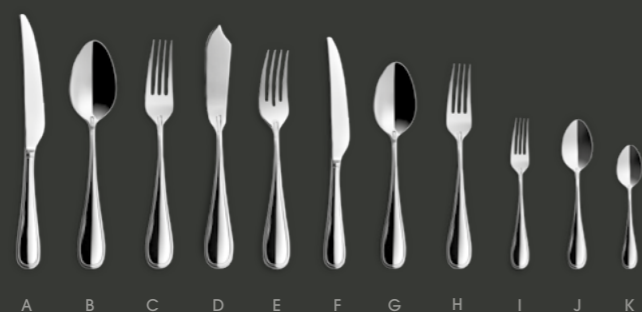

	€	UE	MOQ	▶ mm	✕ mm
A 7968 CUCHILLO MESA table knife, couteau table, coltello tavola, tafeimesser	4,74 €	0/12/60/1920/5760	60	238	
B 7969 CUCHARA MESA table spoon, cuillère table, cucchiaio tavola, tafellöffel	4,56 €	0/12/60/1440/7200	60	213	4
C 7970 TENEDOR MESA table fork, fourchette table, forchetta tavola, tafelgabel	4,56 €	0/12/60/1440/7200	60	213	4
D 7971 PALA PESCADO fish knife, couteau poisson, coltello pesce, fischmesser	4,53 €	0/12/60/1440/7200	60	224	4
E 7972 TENEDOR PESCADO fish fork, fourchette poisson, forchetta pesce, fischgabel	4,53 €	0/12/60/1440/7200	60	200	4
F 7973 CUCHILLO POSTRE dessert knife, couteau dessert, coltello frutta, dessertmesser	4,39 €	0/12/60/1920/5760	60	216	
G 7974 CUCHARA POSTRE dessert spoon, cuillère dessert, cucchiaio frutta, dessertlöffel	3,86 €	0/12/60/1440/7200	60	192	3,5
H 7975 TENEDOR POSTRE dessert fork, fourchette dessert, forchetta frutta, dessertgabel	3,86 €	0/12/60/1440/7200	60	192	3,5
I 7976 TENEDOR LUNCH cake fork, fourchette gâteau, forchetta dolce, kuchengabel	2,34 €	0/12/60/2520/15120	60	140	3
J 7977 CUCHARA CAFÉ tea spoon, cuillère café, cucchiaio caffè, kaffeelöffel	2,34 €	0/12/60/2520/15120	60	140	3
K 7978 CUCHARA MOKA coffee/moka spoon, cuillère moka, cucchiaio moka, mokkalöffel	2,11 €	0/12/60/2520/15120	60	115	2,5
9800 16 PIEZAS 16 pieces, écrin 16 pièces, bauletto 16 pz., 16 stück	68,13 €	1/0/2/5/50	2		4
7979 24 PIEZAS 24 pieces, écrin 24 pièces, bauletto 24 pz., 24 stück	113,30 €	1/0/2/5/50	2		4
8710 30 PIEZAS 30 pieces, écrin 30 pièces, bauletto 30 pz., 30 stück	116,40 €	1/0/2/5/50	2		4





Contour Vintage Gold

INOX 18/10 / 4mm / Vintage



Contour Vintage Copper

INOX 18/10 / 4mm / Vintage



	€	UE	MOQ	▶ mm	✕ mm
A 5783 CUCHILLO MESA table knife, couteau table, coltello tavola, tafelmesser	6,20 €	0/12/60/1920/5760	60	238	
B 5784 CUCHARA MESA table spoon, cuillère table, cucchiaio tavola, tafellöffel	6,79 €	0/12/60/1440/7200	60	213	4
C 5785 TENEDOR MESA table fork, fourchette table, forchetta tavola, tafelgabel	6,79 €	0/12/60/1440/7200	60	213	4
D 5786 CUCHILLO POSTRE dessert knife, couteau dessert, coltello frutta, dessertmesser	5,53 €	0/12/60/1920/5760	60	216	
E 5787 CUCHARA POSTRE dessert spoon, cuillère dessert, cucchiaio frutta, dessertlöffel	5,82 €	0/12/60/1440/7200	60	192	3,5
F 5788 TENEDOR POSTRE dessert fork, fourchette dessert, forchetta frutta, dessertgabel	5,82 €	0/12/60/1440/7200	60	192	3,5
G 5789 TENEDOR LUNCH cake fork, fourchette gâteau, forchetta dolce, kuchengabel	4,43 €	0/12/60/2520/15120	60	140	3
H 5790 CUCHARA CAFÉ tea spoon, cuillère café, cucchiaio caffè, kaffeelöffel	4,43 €	0/12/60/2520/15120	60	140	3
I 5791 CUCHARA MOKA coffee/moka spoon, cuillère moka, cucchiaio moka, mokkalöffel	4,01 €	0/12/60/2520/15120	60	115	2,5
5793 16 PIEZAS 16 pieces, écrin 16 pièces, bauletto 16 pz., 16 Stück	100,96 €	1/0/2/5/50	2	4	
5792 24 PIEZAS 24 pieces, écrin 24 pièces, bauletto 24 pz., 24 Stück	149,39 €	1/0/2/5/50	2	4	
5794 30 PIEZAS 30 pieces, écrin 30 pièces, bauletto 30 pz., 30 Stück	176,00 €	1/0/2/5/50	2	4	



	€	UE	MOQ	▶ mm	✕ mm
A 5771 CUCHILLO MESA table knife, couteau table, coltello tavola, tafelmesser	6,47 €	0/12/60/1920/5760	60	238	
B 5772 CUCHARA MESA table spoon, cuillère table, cucchiaio tavola, tafellöffel	7,06 €	0/12/60/1440/7200	60	213	4
C 5773 TENEDOR MESA table fork, fourchette table, forchetta tavola, tafelgabel	7,06 €	0/12/60/1440/7200	60	213	4
D 5774 CUCHILLO POSTRE dessert knife, couteau dessert, coltello frutta, dessertmesser	5,80 €	0/12/60/1920/5760	60	216	
E 5775 CUCHARA POSTRE dessert spoon, cuillère dessert, cucchiaio frutta, dessertlöffel	6,09 €	0/12/60/1440/7200	60	192	3,5
F 5776 TENEDOR POSTRE dessert fork, fourchette dessert, forchetta frutta, dessertgabel	6,09 €	0/12/60/1440/7200	60	192	3,5
G 5777 TENEDOR LUNCH cake fork, fourchette gâteau, forchetta dolce, kuchengabel	4,71 €	0/12/60/2520/15120	60	140	3
H 5778 CUCHARA CAFÉ tea spoon, cuillère café, cucchiaio caffè, kaffeelöffel	4,71 €	0/12/60/2520/15120	60	140	3
I 5779 CUCHARA MOKA coffee/moka spoon, cuillère moka, cucchiaio moka, mokkalöffel	4,29 €	0/12/60/2520/15120	60	115	2,5
5781 16 PIEZAS 16 pieces, écrin 16 pièces, bauletto 16 pz., 16 Stück	105,32 €	1/0/2/5/50	2	4	
5780 24 PIEZAS 24 pieces, écrin 24 pièces, bauletto 24 pz., 24 Stück	155,94 €	1/0/2/5/50	2	4	
5782 30 PIEZAS 30 pieces, écrin 30 pièces, bauletto 30 pz., 30 Stück	184,18 €	1/0/2/5/50	2	4	





Versailles Satin

Versailles Satin

INOX 18/10 / 3,5mm / Satin



INOX 18/10 / 3,5mm / Satin



A B C D E F G H I



	€	UE	MOQ	▶ mm	Σ mm
A 7765 CUCHILLO MESA table knife, couteau table, coltello tavola, tafelmesser	6,74 €	0/12/60/1920/5760	60	245	
B 7766 CUCHARA MESA table spoon, cuillère table, cucchiaio tavola, tafellöffel	7,07 €	0/12/60/1440/7200	60	210	3,5
C 7767 Tenedor MESA table fork, fourchette table, forchetta tavola, tafelgabel	7,07 €	0/12/60/1440/7200	60	210	3,5
D 7770 CUCHILLO POSTRE dessert knife, couteau dessert, coltello frutta, dessertmesser	6,14 €	0/12/60/1920/5760	60	220	
E 7771 CUCHARA POSTRE dessert spoon, cuillère dessert, cucchiaio frutta, dessertlöffel	5,92 €	0/12/60/1440/7200	60	190	3
F 7772 Tenedor POSTRE dessert fork, fourchette dessert, forchetta frutta, dessertgabel	5,92 €	0/12/60/1440/7200	60	190	3
G 7773 Tenedor LUNCH cake fork, fourchette gâteau, forchetta dolce, kuchengabel	4,67 €	0/12/60/2520/15120	60	140	2,5
H 7774 CUCHARA CAFÉ tea spoon, cuillère café, cucchiaio caffè, kaffeelöffel	4,67 €	0/12/60/2520/15120	60	140	2,5
I 7775 CUCHARA MOKA coffee/moka spoon, cuillère moka, cucchiaio moka, makkalöffel	4,23 €	0/12/60/2520/15120	60	115	1,8
9799 16 PIEZAS 16 pieces, écriin 16 pièces, bauletto 16 pz., 16 stück	77,25 €	1/0/2/5/50	2		3,5
7776 24 PIEZAS 24 pieces, écriin 24 pièces, bauletto 24 pz., 24 stück	117,03 €	1/0/2/5/50	2		3,5
8709 30 PIEZAS 30 pieces, écriin 30 pièces, bauletto 30 pz., 30 stück	131,33 €	1/0/2/5/50	2		3,5





Versailles Satin Gold

INOX 18/10 / 3,5mm / Satin



Versailles Satin Black

INOX 18/10 / 3,5mm / Satin



	€	UE	MOQ	▶ mm	Σ mm
A 5736 CUCHILLO MESA table knife, couteau table, coltello tavola, tafelmesser	6,47 €	0/12/60/1920/5760	60	245	
B 5737 CUCHARA MESA table spoon, cuillère table, cucchiaio tavola, tafellöffel	6,80 €	0/12/60/1440/7200	60	210	3,5
C 5738 TENEDOR MESA table fork, fourchette table, forchetta tavola, tafelgabel	6,80 €	0/12/60/1440/7200	60	210	3,5
D 5739 CUCHILLO POSTRE dessert knife, couteau dessert, coltello frutta, dessertmesser	5,87 €	0/12/60/1920/5760	60	220	
E 5740 CUCHARA POSTRE dessert spoon, cuillère dessert, cucchiaio frutta, dessertlöffel	5,65 €	0/12/60/1440/7200	60	190	3
F 5741 TENEDOR POSTRE dessert fork, fourchette dessert, forchetta frutta, dessertgabel	5,65 €	0/12/60/1440/7200	60	190	3
G 5742 TENEDOR LUNCH cake fork, fourchette gâteau, forchetta dolce, kuchengabel	4,40 €	0/12/60/2520/15120	60	140	2,5
H 5743 CUCHARA CAFÉ tea spoon, cuillère café, cucchiaio caffè, kaffeelöffel	4,40 €	0/12/60/2520/15120	60	140	2,5
I 5744 CUCHARA MOKA coffee/moka spoon, cuillère moka, cucchiaio moka, mokkalöffel	3,96 €	0/12/60/2520/15120	60	115	1,8
8801 16 PIEZAS 16 pieces, écriin 16 pièces, bauletto 16 pz., 16 stück	101,69 €	1/0/2/5/50	2		3,5
8800 24 PIEZAS 24 pieces, écriin 24 pièces, bauletto 24 pz., 24 stück	150,61 €	1/0/2/5/50	2		3,5
8802 30 PIEZAS 30 pieces, écriin 30 pièces, bauletto 30 pz., 30 stück	176,98 €	1/0/2/5/50	2		3,5



	€	UE	MOQ	▶ mm	Σ mm
A 5745 CUCHILLO MESA table knife, couteau table, coltello tavola, tafelmesser	6,74 €	0/12/60/1920/5760	60	245	
B 5746 CUCHARA MESA table spoon, cuillère table, cucchiaio tavola, tafellöffel	7,07 €	0/12/60/1440/7200	60	210	3,5
C 5747 TENEDOR MESA table fork, fourchette table, forchetta tavola, tafelgabel	7,07 €	0/12/60/1440/7200	60	210	3,5
D 5748 CUCHILLO POSTRE dessert knife, couteau dessert, coltello frutta, dessertmesser	6,14 €	0/12/60/1920/5760	60	220	
E 5749 CUCHARA POSTRE dessert spoon, cuillère dessert, cucchiaio frutta, dessertlöffel	5,92 €	0/12/60/1440/7200	60	190	3
F 5750 TENEDOR POSTRE dessert fork, fourchette dessert, forchetta frutta, dessertgabel	5,92 €	0/12/60/1440/7200	60	190	3
G 5751 TENEDOR LUNCH cake fork, fourchette gâteau, forchetta dolce, kuchengabel	4,67 €	0/12/60/2520/15120	60	140	2,5
H 5752 CUCHARA CAFÉ tea spoon, cuillère café, cucchiaio caffè, kaffeelöffel	4,67 €	0/12/60/2520/15120	60	140	2,5
I 5753 CUCHARA MOKA coffee/moka spoon, cuillère moka, cucchiaio moka, mokkalöffel	4,23 €	0/12/60/2520/15120	60	115	1,8
8804 16 PIEZAS 16 pieces, écriin 16 pièces, bauletto 16 pz., 16 stück	106,05 €	1/0/2/5/50	2		3,5
8803 24 PIEZAS 24 pieces, écriin 24 pièces, bauletto 24 pz., 24 stück	157,15 €	1/0/2/5/50	2		3,5
8805 30 PIEZAS 30 pieces, écriin 30 pièces, bauletto 30 pz., 30 stück	185,16 €	1/0/2/5/50	2		3,5





Versailles Satin



INOX 18/10 / 3,5mm / Satin



A B C D E F G H I



Versailles Satin Copper

INOX 18/10 / 3,5mm / Satin



	€	UE	MOQ	▶ mm	✂ mm
A 5754 CUCHILLO MESA table knife, couteau table, coltello tavola, tafelmesser	6,74 €	0/12/60/1920/5760	60	245	
B 5755 CUCHARA MESA table spoon, cuillère table, cucchiaio tavola, tafellöffel	7,07 €	0/12/60/1440/7200	60	210	3,5
C 5756 Tenedor MESA table fork, fourchette table, forchetta tavola, tafelgabel	7,07 €	0/12/60/1440/7200	60	210	3,5
D 5757 CUCHILLO POSTRE dessert knife, couteau dessert, coltello frutta, dessertmesser	6,14 €	0/12/60/1920/5760	60	220	
E 5758 CUCHARA POSTRE dessert spoon, cuillère dessert, cucchiaio frutta, dessertlöffel	5,92 €	0/12/60/1440/7200	60	190	3
F 5759 Tenedor POSTRE dessert fork, fourchette dessert, forchetta frutta, dessertgabel	5,92 €	0/12/60/1440/7200	60	190	3
G 5760 Tenedor LUNCH cake fork, fourchette gâteau, forchetta dolce, kuchengabel	4,67 €	0/12/60/2520/15120	60	140	2,5
H 5761 CUCHARA CAFÉ tea spoon, cuillère café, cucchiaio caffè, kaffeelöffel	4,67 €	0/12/60/2520/15120	60	140	2,5
I 5762 CUCHARA MOKA coffee/moka spoon, cuillère moka, cucchiaio moka, mokkalöffel	4,23 €	0/12/60/2520/15120	60	115	1,8
8807 16 PIEZAS 16 pieces, écrin 16 pièces, bauletto 16 pz., 16 Stück	106,05 €	1/0/2/5/50	2		3,5
8806 24 PIEZAS 24 pieces, écrin 24 pièces, bauletto 24 pz., 24 Stück	157,15 €	1/0/2/5/50	2		3,5
8808 30 PIEZAS 30 pieces, écrin 30 pièces, bauletto 30 pz., 30 Stück	185,16 €	1/0/2/5/50	2		3,5





Maranta

Maranta 

INOX 18/10 / 4mm / Mirror



INOX 18/10 / 4mm / Mirror

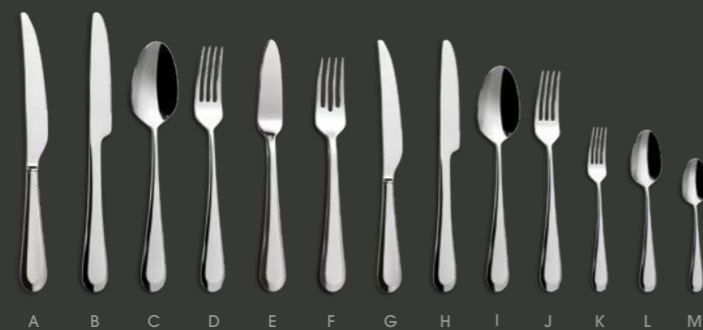

	€	UE	MOQ	✂ mm	✂ mm
A 7288 CUCHILLO MESA CLASICO classic table knife, couteau table classic, coltello tavola classic, tafelmesser classic	4,44 €	0/12/120/1920/5760	60	238	
B 6485 CUCHILLO MESA table knife, couteau table, coltello tavola, tafelmesser	3,97 €	0/12/120/1920/5760	60	238	
C 6486 CUCHARA MESA table spoon, cuillère table, cucchiaio tavola, tafellöffel	3,77 €	0/12/120/1440/7200	60	212	4
D 6487 TENEDOR MESA table fork, fourchette table, forchetta tavola, tafelgabel	3,77 €	0/12/120/1440/7200	60	212	4
E 6488 PALA PESCADO fish knife, couteau poisson, coltello pesce, fischmesser	3,77 €	0/12/120/1440/7200	60	215	4
F 6489 TENEDOR PESCADO fish fork, fourchette poisson, forchetta pesce, fischgabel	3,77 €	0/12/120/1440/7200	60	200	4
G 6691 CUCHILLO POSTRE CLASICO classic dessert knife, couteau dessert classic, coltello frutta classic, dessertmesser classic	3,66 €	0/12/120/1920/5760	60	214	
H 6490 CUCHILLO POSTRE dessert knife, couteau dessert, coltello frutta, dessertmesser	3,60 €	0/12/120/1920/5760	60	214	
I 6491 CUCHARA POSTRE dessert spoon, cuillère dessert, cucchiaio frutta, dessertlöffel	3,14 €	0/12/120/1440/7200	60	191	3,5
J 6492 TENEDOR POSTRE dessert fork, fourchette dessert, forchetta frutta, dessertgabel	3,14 €	0/12/120/1440/7200	60	191	3,5
K 6493 TENEDOR LUNCH cake fork, fourchette gâteau, forchetta dolce, kuchengabel	2,36 €	0/12/120/2520/15120	60	140	3,5
L 6494 CUCHARA CAFÉ tea spoon, cuillère café, cucchiaio caffè, kaffeelöffel	2,36 €	0/12/120/2520/15120	60	140	3,5
M 6495 CUCHARA MOKA coffee/moka spoon, cuillère moka, cucchiaio moka, mokkalöffel	2,05 €	0/12/120/2520/15120	60	114	3,5
9783 16 PIEZAS 16 pieces, écrin 16 pièces, bauletto 16 pz., 16 Stück	74,62 €	1/0/2/5/50	2		3,5
6496 24 PIEZAS 24 pieces, écrin 24 pièces, bauletto 24 pz., 24 Stück	113,05 €	1/0/2/5/50	2		3,5
8698 30 PIEZAS 30 pieces, écrin 30 pièces, bauletto 30 pz., 30 Stück	126,54 €	1/0/2/5/50	2		3,5





Maranta Vintage



INOX 18/10 / 4mm / Vintage

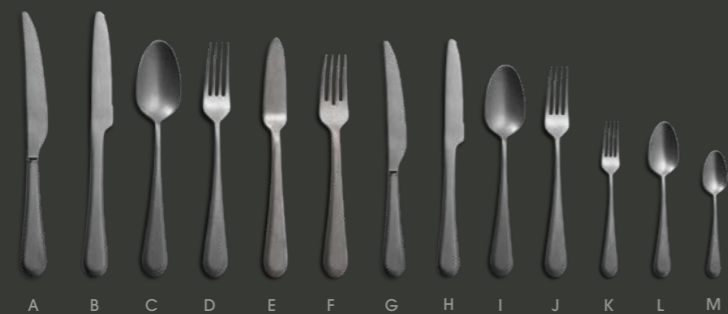

A B C D E F G H I J K L M

Maranta Vintage

INOX 18/10 / 4mm / Vintage

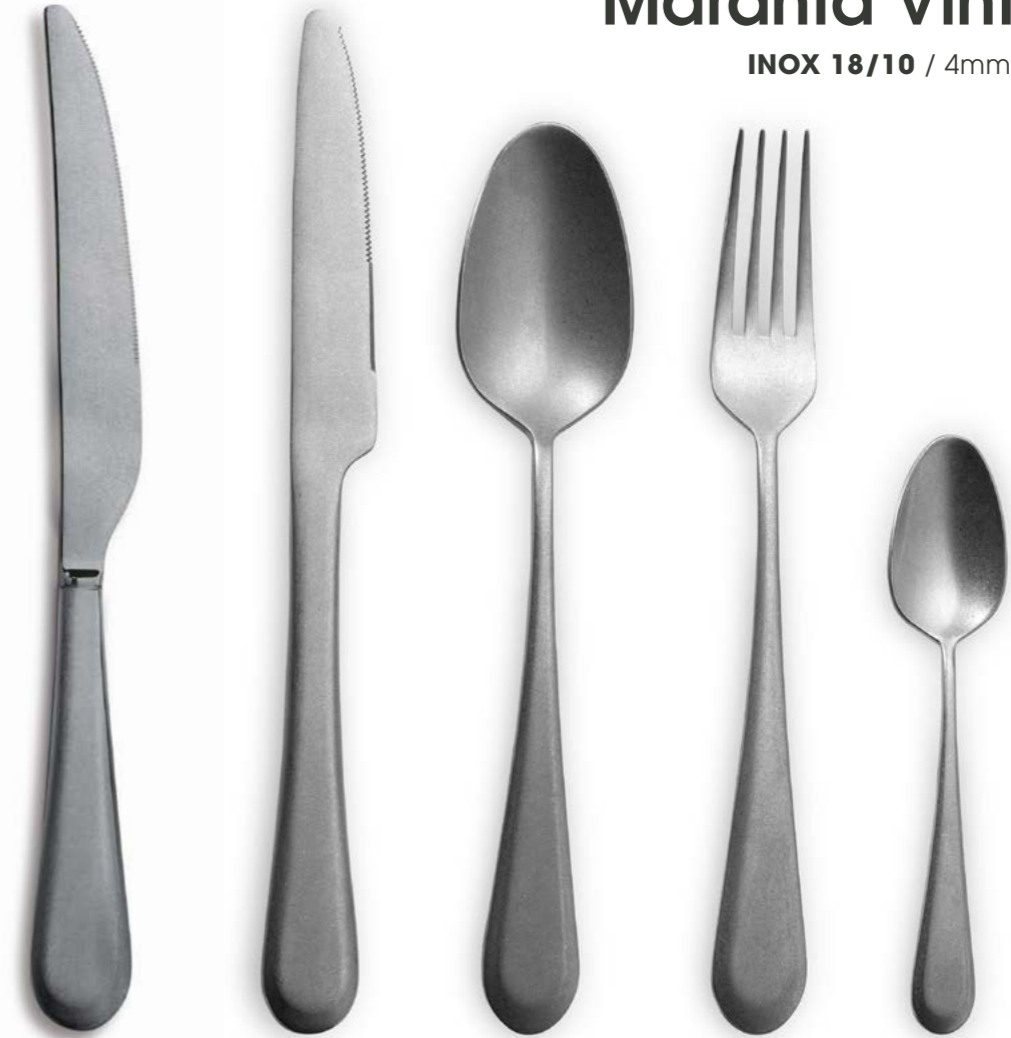

	€	UE	MOQ	▶ mm	✂ mm
A 7784 CUCHILLO MESA CLASICO classic table knife, couteau table classic, coltello tavola classic, tafelmesser classic	4,64 €	0/12/120/1920/5760	60	238	
B 6793 CUCHILLO MESA table knife, couteau table, coltello tavola, tafelmesser	4,50 €	0/12/120/1920/5760	60	238	
C 6794 CUCHARA MESA table spoon, cuillère table, cucchiaio tavola, tafellöffel	4,36 €	0/12/120/1440/7200	60	212	4
D 6795 TENEDOR MESA table fork, fourchette table, forchetta tavola, tafelgabel	4,36 €	0/12/120/1440/7200	60	212	4
E 6796 PALA PESCADO fish knife, couteau poisson, coltello pesce, fischmesser	4,36 €	0/12/120/1440/7200	60	215	4
F 6797 TENEDOR PESCADO fish fork, fourchette poisson, forchetta pesce, fischgabel	4,36 €	0/12/120/1440/7200	60	200	4
G 6692 CUCHILLO POSTRE CLASICO classic dessert knife, couteau dessert classic, coltello frutta classic, dessertmesser classic	4,24 €	0/12/120/1920/5760	60	214	
H 6798 CUCHILLO POSTRE dessert knife, couteau dessert, coltello frutta, dessertmesser	4,14 €	0/12/120/1920/5760	60	214	
I 6799 CUCHARA POSTRE dessert spoon, cuillère dessert, cucchiaio frutta, dessertlöffel	3,75 €	0/12/120/1440/7200	60	191	3,5
J 6800 TENEDOR POSTRE dessert fork, fourchette dessert, forchetta frutta, dessertgabel	3,75 €	0/12/120/1440/7200	60	191	3,5
K 6801 TENEDOR LUNCH cake fork, fourchette gâteau, forchetta dolce, kuchengabel	2,83 €	0/12/120/2520/15120	60	140	3,5
L 6802 CUCHARA CAFÉ tea spoon, cuillère café, cucchiaio caffè, kaffeelöffel	2,83 €	0/12/120/2520/15120	60	140	3,5
M 6803 CUCHARA MOKA coffee/moka spoon, cuillère moka, cucchiaio moka, mokkalöffel	2,65 €	0/12/120/2520/15120	60	114	3,5
9784 16 PIEZAS 16 pieces, écrin 16 pièces, bauletto 16 pz., 16 stück	82,22 €	1/0/2/5/50	2	4	
6804 24 PIEZAS 24 pieces, écrin 24 pièces, bauletto 24 pz., 24 stück	123,36 €	1/0/2/5/50	2	4	
8699 30 PIEZAS 30 pieces, écrin 30 pièces, bauletto 30 pz., 30 stück	140,29 €	1/0/2/5/50	2	4	





London

London 
INOX 18/10 / 4mm / Mirror



INOX 18/10 / 4mm / Mirror



	€	UE	MOQ	✂ mm	✂ mm
A 6700 CUCHILLO CHULETERO steak knife, couteau steak, coltello bistecca, steakmesser	3,31 €	0/12/120/1920/5760	60	233	
B 9836 CUCHILLO MESA RK RK table knife, couteau table RK, coltello tavola RK, RK tafelmesser	3,46 €	0/12/120/1920/5760	60	238	6,2
C 6701 CUCHILLO MESA table knife, couteau table, coltello tavola, tafelmesser	3,31 €	0/12/120/1920/5760	60	228	
D 6702 CUCHARA MESA table spoon, cuillère table, cucchiaio tavola, tafellöffel	3,08 €	0/12/120/1440/7200	60	208	4
E 6703 TENEDOR MESA table fork, fourchette table, forchetta tavola, tafelgabel	3,08 €	0/12/120/1440/7200	60	208	4
F 6497 PALA PESCADO fish knife, couteau poisson, coltello pesce, fischmesser	3,07 €	0/12/120/1440/7200	60	212	4
G 6498 TENEDOR PESCADO fish fork, fourchette poisson, forchetta pesce, fischgabel	3,07 €	0/12/120/1440/7200	60	205	4
H 9837 CUCHILLO POSTRE RK RK dessert knife, couteau dessert RK, coltello frutta RK, RK dessertmesser	3,19 €	0/12/120/1920/5760	60	209	5,6
I 6704 CUCHILLO POSTRE dessert knife, couteau dessert, coltello frutta, dessertmesser	3,08 €	0/12/120/1920/5760	60	208	
J 6705 CUCHARA POSTRE dessert spoon, cuillère dessert, cucchiaio frutta, dessertlöffel	2,79 €	0/12/120/1440/7200	60	186	3,5
K 6706 TENEDOR POSTRE dessert fork, fourchette dessert, forchetta frutta, dessertgabel	2,79 €	0/12/120/1440/7200	60	186	3,5
L 6707 TENEDOR LUNCH cake fork, fourchette gâteau, forchetta dolce, kuchengabel	1,70 €	0/12/120/2520/15120	60	152	2,5
M 6708 CUCHARA CAFÉ tea spoon, cuillère café, cucchiaio caffè, kaffeelöffel	1,70 €	0/12/120/2520/15120	60	150	2,5
N 6709 CUCHARA MOKA coffee/moka spoon, cuillère moka, cucchiaio moka, mokkalöffel	1,45 €	0/12/120/2520/15120	60	115	2
9802 16 PIEZAS 16 pieces, écin 16 pièces, bauletto 16 pz., 16 Stück	54,82 €	1/0/4/56/112	4	4	4
6710 24 PIEZAS 24 pieces, écin 24 pièces, bauletto 24 pz., 24 Stück	85,29 €	1/0/4/56/112	4	4	4
8712 30 PIEZAS 30 pieces, écin 30 pièces, bauletto 30 pz., 30 Stück	95,33 €	1/0/4/56/112	4	4	4





London Vintage



INOX 18/10 / 4mm / Vintage



London Vintage

INOX 18/10 / 4mm / Vintage



	€	UE	MOQ	▶ mm	✂ mm
A 6805 CUCHILLO CHULETERO steak knife, couteau steak, coltello bistecca, steakmesser	3,95 €	0/12/120/1920/5760	60	233	
B 9840 CUCHILLO MESA RK RK table knife, couteau table RK, coltello tavola RK, RK tafelmesser	3,81 €	0/12/120/1920/5760	60	238	
C 6806 CUCHILLO MESA table knife, couteau table, coltello tavola, tafelmesser	3,79 €	0/12/120/1920/5760	60	228	
D 6807 CUCHARA MESA table spoon, cuillère table, cucchiaio tavola, tafellöffel	3,67 €	0/12/120/1440/7200	60	208	4
E 6808 TENEDOR MESA table fork, fourchette table, forchetta tavola, tafelgabel	3,67 €	0/12/120/1440/7200	60	208	4
F 6809 PALA PESCADO fish knife, couteau poisson, coltello pesce, fischmesser	3,66 €	0/12/120/1440/7200	60	212	4
G 6810 TENEDOR PESCADO fish fork, fourchette poisson, forchetta pesce, fischgabel	3,66 €	0/12/120/1440/7200	60	205	4
H 9841 CUCHILLO POSTRE RK RK dessert knife, couteau dessert RK, coltello frutta RK, RK dessertmesser	3,72 €	0/12/120/1920/5760	60	209	
I 6811 CUCHILLO POSTRE dessert knife, couteau dessert, coltello frutta, dessertmesser	3,61 €	0/12/120/1920/5760	60	208	
J 6812 CUCHARA POSTRE dessert spoon, cuillère dessert, cucchiaio frutta, dessertlöffel	3,53 €	0/12/120/1440/7200	60	186	3,5
K 6813 TENEDOR POSTRE dessert fork, fourchette dessert, forchetta frutta, dessertgabel	3,53 €	0/12/120/1440/7200	60	186	3,5
L 6814 TENEDOR LUNCH cake fork, fourchette gâteau, forchetta dolce, kuchengabel	2,33 €	0/12/120/2520/15120	60	152	2,5
M 6815 CUCHARA CAFÉ tea spoon, cuillère café, cucchiaio caffè, kaffeelöffel	2,33 €	0/12/120/2520/15120	60	150	2,5
N 6816 CUCHARA MOKA coffee/moka spoon, cuillère moka, cucchiaio moka, mokkalöffel	2,11 €	0/12/120/2520/15120	60	115	2
9803 16 PIEZAS 16 pieces, écrin 16 pièces, bauletto 16 pz., 16 stück	59,89 €	1/0/4/56/112	4		4
6817 24 PIEZAS 24 pieces, écrin 24 pièces, bauletto 24 pz., 24 stück	90,16 €	1/0/4/56/112	4		4
8713 30 PIEZAS 30 pieces, écrin 30 pièces, bauletto 30 pz., 30 stück	103,46 €	1/0/4/56/112	4		4





	€	UE	MOQ	✂ mm	✂ mm
A 7046 CUCHILLO MESA table knife, couteau table, coltello tavola, tafelmesser	4,39 €	0/12/120/1920/5760	60	240	
B 7047 CUCHARA MESA table spoon, cuillère table, cucchiaio tavola, tafellöffel	3,33 €	0/12/120/1440/7200	60	214	4
C 7048 TENEDOR MESA table fork, fourchette table, forchetta tavola, tafelgabel	3,33 €	0/12/120/1440/7200	60	213	4
D 7049 PALA PESCADO fish knife, couteau poisson, coltello pesce, fischmesser	3,20 €	0/12/120/1440/7200	60	187	3,5
E 7050 TENEDOR PESCADO fish fork, fourchette poisson, forchetta pesce, fischgabel	3,20 €	0/12/120/1440/7200	60	174	3,5
F 7051 CUCHILLO POSTRE dessert knife, couteau dessert, coltello frutta, dessertmesser	3,91 €	0/12/120/1920/5760	60	209	
G 7052 CUCHARA POSTRE dessert spoon, cuillère dessert, cucchiaio frutta, dessertlöffel	2,95 €	0/12/120/1440/7200	60	176	3,5
H 7053 TENEDOR POSTRE dessert fork, fourchette dessert, forchetta frutta, dessertgabel	2,95 €	0/12/120/1440/7200	60	175	3,5
I 7054 TENEDOR LUNCH cake fork, fourchette gâteau, forchetta dolce, kuchengabel	2,22 €	0/12/120/2520/15120	60	147	3
J 7055 CUCHARA CAFÉ tea spoon, cuillère café, cucchiaio caffè, koffeelöffel	2,22 €	0/12/120/2520/15120	60	147	3
K 7056 CUCHARA MOKA coffee/moka spoon, cuillère moka, cucchiaio moka, mokkalöffel	2,09 €	0/12/120/2520/15120	60	121	2,5
9776 16 PIEZAS 16 pieces, écriin 16 pièces, bauletto 16 pz., 16 stück	60,29 €	1/0/2/5/50	2	4	
5962 24 PIEZAS 24 pieces, écriin 24 pièces, bauletto 24 pz., 24 stück	90,44 €	1/0/2/5/50	2	4	
8691 30 PIEZAS 30 pieces, écriin 30 pièces, bauletto 30 pz., 30 stück	103,77 €	1/0/2/5/50	2	4	



	€	UE	MOQ	✂ mm	✂ mm
A 7033 CUCHILLO CHULETERO steak knife, couteau steak, coltello bistecca, steakmesser	4,64 €	0/12/120/1920/5760	60	244	
B 7034 CUCHILLO MESA table knife, couteau table, coltello tavola, tafelmesser	4,64 €	0/12/120/1920/5760	60	237	
C 7035 CUCHARA MESA table spoon, cuillère table, cucchiaio tavola, tafellöffel	3,54 €	0/12/120/1440/7200	60	207	4
D 7036 TENEDOR MESA table fork, fourchette table, forchetta tavola, tafelgabel	3,54 €	0/12/120/1440/7200	60	206	4
E 7037 PALA PESCADO fish knife, couteau poisson, coltello pesce, fischmesser	2,95 €	0/12/120/1440/7200	60	195	3,5
F 7038 TENEDOR PESCADO fish fork, fourchette poisson, forchetta pesce, fischgabel	2,95 €	0/12/120/1440/7200	60	176	3,5
G 7039 CUCHILLO POSTRE dessert knife, couteau dessert, coltello frutta, dessertmesser	3,91 €	0/12/120/1920/5760	60	195	
H 7040 CUCHARA POSTRE dessert spoon, cuillère dessert, cucchiaio frutta, dessertlöffel	2,77 €	0/12/120/1440/7200	60	178	3,5
I 7041 TENEDOR POSTRE dessert fork, fourchette dessert, forchetta frutta, dessertgabel	2,77 €	0/12/120/1440/7200	60	179	3,5
J 7042 TENEDOR LUNCH cake fork, fourchette gâteau, forchetta dolce, kuchengabel	1,82 €	0/12/120/2520/15120	60	142	3
K 7043 CUCHARA CAFÉ tea spoon, cuillère café, cucchiaio caffè, koffeelöffel	1,82 €	0/12/120/2520/15120	60	135	3
L 7044 CUCHARA MOKA coffee/moka spoon, cuillère moka, cucchiaio moka, mokkalöffel	1,57 €	0/12/120/2520/15120	60	111	2,5
M 7045 CUCHARA CONSOMÉ consommé spoon, cuillère consommé, cucchiaio zuppa, bouillonlöffel	2,83 €	0/12/120/1440/7200	60	166	3,5
9775 16 PIEZAS 16 pieces, écriin 16 pièces, bauletto 16 pz., 16 stück	68,68 €	1/0/2/5/50	2	4	
5961 24 PIEZAS 24 pieces, écriin 24 pièces, bauletto 24 pz., 24 stück	103,00 €	1/0/2/5/50	2	4	
8690 30 PIEZAS 30 pieces, écriin 30 pièces, bauletto 30 pz., 30 stück	113,56 €	1/0/2/5/50	2	4	





	€	UE	MOQ	▶ mm	✂ mm
A 5033 CUCHILLO MESA table knife, couteau table, coltello tavola, tafelmesser	3,04 €	0/12/120/1920/5760	60	235	
B 3700 CUCHARA MESA table spoon, cuillère table, cucchiaio tavola, tafellöffel	3,04 €	0/12/120/1440/7200	60	200	3,5
C 3701 TENEDOR MESA table fork, fourchette table, forchetta tavola, tafelgabel	3,04 €	0/12/120/1440/7200	60	200	3,5
D 3702 PALA PESCADO fish knife, couteau poisson, coltello pesce, fischmesser	2,69 €	0/12/120/1440/7200	60	205	3
E 3703 TENEDOR PESCADO fish fork, fourchette poisson, forchetta pesce, fischgabel	2,94 €	0/12/120/1440/7200	60	195	3
F 5034 CUCHILLO POSTRE dessert knife, couteau dessert, coltello frutta, dessertmesser	2,89 €	0/12/120/1920/5760	60	210	
G 3704 CUCHARA POSTRE dessert spoon, cuillère dessert, cucchiaio frutta, dessertlöffel	2,45 €	0/12/120/1440/7200	60	180	2,5
H 3705 TENEDOR POSTRE dessert fork, fourchette dessert, forchetta frutta, dessertgabel	2,45 €	0/12/120/1440/7200	60	180	2,5
I 3706 TENEDOR LUNCH cake fork, fourchette gâteau, forchetta dolce, kuchengabel	1,68 €	0/12/120/2520/15120	60	148	2
J 3707 CUCHARA CAFÉ tea spoon, cuillère café, cucchiaio caffè, kaffeelöffel	1,66 €	0/12/120/2520/15120	60	140	2
K 3708 CUCHARA MOKA coffee/moka spoon, cuillère moka, cucchiaio moka, mokkalöffel	1,49 €	0/12/120/2520/15120	60	116	2
B 9626 CUCHARA MESA 18% table spoon 18%, cuillère table 18%, cucchiaio tavola 18%, tafellöffel 18%	2,01 €	0/12/120/1440/7200	60	200	3,5
C 9627 TENEDOR MESA 18% table fork 18%, fourchette table 18%, forchetta tavola 18%, tafelgabel 18%	2,01 €	0/12/120/1440/7200	60	200	3,5
J 9628 CUCHARA CAFÉ 18% tea spoon 18%, cuillère café 18%, cucchiaio caffè 18%, kaffeelöffel 18%	1,16 €	0/12/120/2520/15120	60	140	2
9807 16 PIEZAS 16 pieces, écriin 16 pièces, bauletto 16 pz., 16 stück	47,71 €	1/0/4/56/112	4		3,5
0706 24 PIEZAS 24 pieces, écriin 24 pièces, bauletto 24 pz., 24 stück	71,58 €	1/0/4/56/112	4		3,5
8717 30 PIEZAS 30 pieces, écriin 30 pièces, bauletto 30 pz., 30 stück	81,25 €	1/0/4/56/112	4		3,5



	€	UE	MOQ	▶ mm	✂ mm
A 6696 CUCHILLO CHULETERO steak knife, couteau steak, coltello bistecca, steakmesser	3,60 €	0/12/120/1920/5760	60	235	
B 3139 CUCHILLO MESA table knife, couteau table, coltello tavola, tafelmesser	3,60 €	0/12/120/1920/5760	60	225	
C 3141 CUCHARA MESA table spoon, cuillère table, cucchiaio tavola, tafellöffel	3,52 €	0/12/120/1440/7200	60	211	4
D 3142 TENEDOR MESA table fork, fourchette table, forchetta tavola, tafelgabel	3,52 €	0/12/120/1440/7200	60	211	4
E 3143 PALA PESCADO fish knife, couteau poisson, coltello pesce, fischmesser	3,01 €	0/12/120/1440/7200	60	206	3,5
F 3144 TENEDOR PESCADO fish fork, fourchette poisson, forchetta pesce, fischgabel	3,01 €	0/12/120/1440/7200	60	186	3,5
G 3145 CUCHILLO POSTRE dessert knife, couteau dessert, coltello frutta, dessertmesser	2,81 €	0/12/120/1920/5760	60	195	
H 3146 CUCHARA POSTRE dessert spoon, cuillère dessert, cucchiaio frutta, dessertlöffel	2,83 €	0/12/120/1440/7200	60	188	3,5
I 3147 TENEDOR POSTRE dessert fork, fourchette dessert, forchetta frutta, dessertgabel	2,83 €	0/12/120/1440/7200	60	186	3,5
J 3148 TENEDOR LUNCH cake fork, fourchette gâteau, forchetta dolce, kuchengabel	2,05 €	0/12/120/2520/15120	60	147	3
K 3149 CUCHARA CAFÉ tea spoon, cuillère café, cucchiaio caffè, kaffeelöffel	2,05 €	0/12/120/2520/15120	60	139	3
L 3150 CUCHARA MOKA coffee/moka spoon, cuillère moka, cucchiaio moka, mokkalöffel	1,58 €	0/12/120/2520/15120	60	114	2,5
M 3176 PALA MANTEQUILLA butter knife, couteau beurre, coltello burro, buttermesser	2,70 €	0/12/120/1440/7200	60	180	
C 9629 CUCHARA MESA 18% table spoon 18%, cuillère table 18%, cucchiaio tavola 18%, tafellöffel 18%	1,87 €	0/12/120/1440/7200	60	211	3,5
D 9630 TENEDOR MESA 18% table fork 18%, fourchette table 18%, forchetta tavola 18%, tafelgabel 18%	1,87 €	0/12/120/1440/7200	60	211	3,5
K 9631 CUCHARA CAFÉ 18% tea spoon 18%, cuillère café 18%, cucchiaio caffè 18%, kaffeelöffel 18%	1,38 €	0/12/120/2520/15120	60	139	3,5
9774 16 PIEZAS 16 pieces, bauletto 16 pz., 16 stück	58,62 €	1/0/2/5/50	2		4
5960 24 PIEZAS 24 pieces, écriin 24 pièces, bauletto 24 pz., 24 stück	87,93 €	1/0/2/5/50	2		4
8689 30 PIEZAS 30 pieces, écriin 30 pièces, bauletto 30 pz., 30 stück	100,04 €	1/0/2/5/50	2		4





Rosewood

Rosewood 
INOX 18/10 / 2,5mm / Mirror



INOX 18/10 / 2,5mm / Mirror



A B C D



- A **6669** CUCHILLO MESA
table knife, couteau table, coltello tavola, tafelmesser
- B **6670** CUCHARA MESA
table spoon, cuillère table, cucchiaio tavola, tafellöffel
- C **6671** TENEDOR MESA
table fork, fourchette table, forchetta tavola, tafelgabel
- D **6672** CUCHARA CAFÉ
tea spoon, cuillère café, cucchiaio caffè, kaffeelöffel
- 6673** 24 PIEZAS
24 pieces, écrin 24 pièces, bauletto 24 pz., 24 stück

€	UE	MOQ	▶ mm	✂ mm
6,88 €	0/6/96/2016/6048	60	228	
6,88 €	0/6/96/1728/3456	60	203	2,5
6,88 €	0/6/96/1728/3456	60	203	2,5
5,92 €	0/6/96/2016/6048	60	140	2
148,28 €	1/0/4/56/112	4		2,5





Munich

Munich 

INOX 18/10 / 3,5mm / Mirror

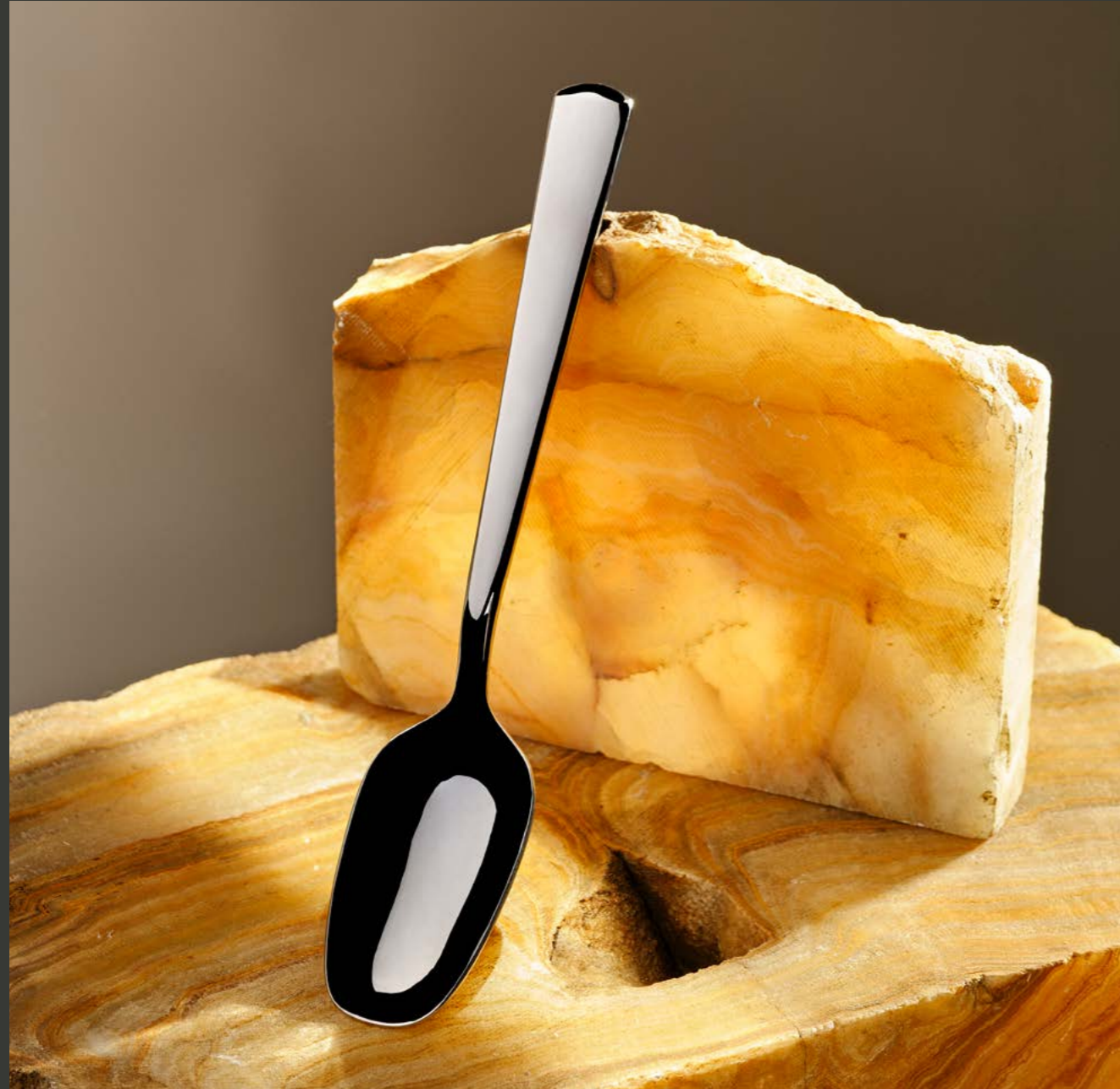

INOX 18/10 / 3,5mm / Mirror

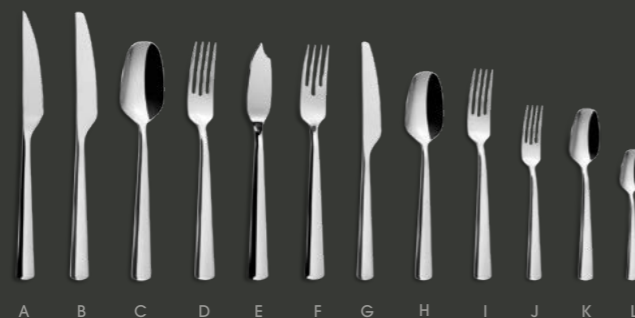

A B C D E F G H I J K L



	€	UE	MOQ	▶ mm	✂ mm
A 6511 CUCHILLO CHULETERO steak knife, couteau steak, coltello bistecca, steakhmesser	2,99 €	0/12/120/1920/5760	60	237	
B 6512 CUCHILLO MESA table knife, couteau table, coltello tavola, tafeimesser	3,08 €	0/12/120/1920/5760	60	235	
C 6513 CUCHARA MESA table spoon, cuillère table, cucchiaino tavola, tafellöffel	2,90 €	0/12/120/1440/7200	60	210	3,5
D 6514 TENEDOR MESA table fork, fourchette table, forchetta tavola, tafelgabel	2,90 €	0/12/120/1440/7200	60	209	3,5
E 6515 PALA PESCADO fish knife, couteau poisson, coltello pesce, fischmesser	2,77 €	0/12/120/1440/7200	60	210	3
F 6516 TENEDOR PESCADO fish fork, fourchette poisson, forchetta pesce, fischgabel	2,77 €	0/12/120/1440/7200	60	207	3
G 6517 CUCHILLO POSTRE dessert knife, couteau dessert, coltello frutta, dessertmesser	2,90 €	0/12/120/1920/5760	60	209	
H 6518 CUCHARA POSTRE dessert spoon, cuillère dessert, cucchiaino frutta, dessertlöffel	2,62 €	0/12/120/1440/7200	60	182	3
I 6519 TENEDOR POSTRE dessert fork, fourchette dessert, forchetta frutta, dessertgabel	2,62 €	0/12/120/1440/7200	60	186	3
J 6520 TENEDOR LUNCH cake fork, fourchette gâteau, forchetta dolce, kuchengabel	1,78 €	0/12/120/2520/15120	60	153	2,5
K 6521 CUCHARA CAFÉ tea spoon, cuillère café, cucchiaino caffè, kaffeelöffel	1,78 €	0/12/120/2520/15120	60	150	2,5
L 6522 CUCHARA MOKA coffee/moka spoon, cuillère moka, cucchiaino moka, mokkalöffel	1,60 €	0/12/120/2520/15120	60	115	2,5
9806 16 PIEZAS pièces, bauletto 16 pz., 16 Stück	47,71 €	1/0/4/56/112	4		3,5
6523 24 PIEZAS 24 pieces, écin 24 pièces, bauletto 24 pz., 24 Stück	71,58 €	1/0/4/56/112	4		3,5
8716 30 PIEZAS 30 pieces, écin 30 pièces, bauletto 30 pz., 30 Stück	80,68 €	1/0/4/56/112	4		3,5



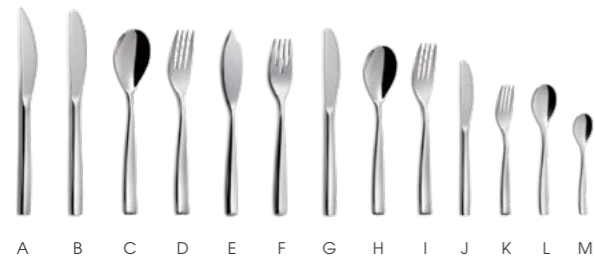

A	0764	CUCHILLO CHULETERO steak knife, couteau steak, coltello bistecca, steakmesser
B	0268	CUCHILLO MESA table knife, couteau table, coltello tavola, tafelmesser
C	2736	CUCHARA MESA table spoon, cuillère table, cucchiaio tavola, tafellöffel
D	2735	TENEDOR MESA table fork, fourchette table, forchetta tavola, tafelgabel
E	2742	PALA PESCADO fish knife, couteau poisson, coltello pesce, fischmesser
F	2741	TENEDOR PESCADO fish fork, fourchette poisson, forchetta pesce, fischgabel
G	5807	CUCHILLO POSTRE dessert knife, couteau dessert, coltello frutta, dessertmesser
H	2740	CUCHARA POSTRE dessert spoon, cuillère dessert, cucchiaio frutta, dessertlöffel
I	2738	TENEDOR POSTRE dessert fork, fourchette dessert, forchetta frutta, dessertgabel
J	5814	CUCHILLO LUNCH cake knife, couteau gâteau, coltello dolce, kuchenmesser
K	2745	TENEDOR LUNCH cake fork, fourchette gâteau, forchetta dolce, kuchengabel
L	2743	CUCHARA CAFÉ tea spoon, cuillère café, cucchiaio caffè, kaffeelöffel
M	2744	CUCHARA MOKA coffee/moka spoon, cuillère moka, cucchiaio moka, mokkalöffel
	9805	16 PIEZAS pièces, bauletto 16 pz., 16 Stück
	2797	24 PIEZAS 24 pieces, écrin 24 pièces, bauletto 24 pz., 24 Stück
	8715	30 PIEZAS 30 pieces, écrin 30 pièces, bauletto 30 pz., 30 Stück

€	UE	MOQ	▶ mm	✂ mm
3,36 €	0/12/120/1920/5760	60	223	
3,36 €	0/12/120/1920/5760	60	221	
3,03 €	0/12/120/1440/7200	60	200	3,5
3,03 €	0/12/120/1440/7200	60	200	3,5
2,62 €	0/12/120/1440/7200	60	200	2,5
2,62 €	0/12/120/1440/7200	60	190	2,5
3,15 €	0/12/120/1920/5760	60	202	
2,62 €	0/12/120/1440/7200	60	183	2,5
2,62 €	0/12/120/1440/7200	60	185	2,5
2,89 €	0/12/120/1920/5760	60	167	
1,58 €	0/12/120/2520/15120	60	140	2,5
1,58 €	0/12/120/2520/15120	60	140	2,5
1,48 €	0/12/120/2520/15120	60	110	2,5
47,71 €	1/0/4/56/112	4		3,5
71,58 €	1/0/4/56/112	4		3,5
80,68 €	1/0/4/56/112	4		3,5



A	5821	CUCHILLO MESA table knife, couteau table, coltello tavola, tafelmesser
B	5822	CUCHARA MESA table spoon, cuillère table, cucchiaio tavola, tafellöffel
C	5823	TENEDOR MESA table fork, fourchette table, forchetta tavola, tafelgabel
D	5824	PALA PESCADO fish knife, couteau poisson, coltello pesce, fischmesser
E	5825	TENEDOR PESCADO fish fork, fourchette poisson, forchetta pesce, fischgabel
F	5826	CUCHILLO POSTRE dessert knife, couteau dessert, coltello frutta, dessertmesser
G	5827	CUCHARA POSTRE dessert spoon, cuillère dessert, cucchiaio frutta, dessertlöffel
H	5828	TENEDOR POSTRE dessert fork, fourchette dessert, forchetta frutta, dessertgabel
I	5829	TENEDOR LUNCH cake knife, couteau gâteau, forchetta dolce, kuchengabel
J	5830	CUCHARA CAFÉ tea spoon, cuillère café, cucchiaio caffè, kaffeelöffel
K	5831	CUCHARA MOKA coffee/moka spoon, cuillère moka, cucchiaio moka, mokkalöffel
L	3158	CUCHARA CONSOMÉ consommé spoon, cuillère consommé, cucchiaio zuppa, bouilloniöffel
M	0463	CAZO SOPA soup ladle, louche à potage, mestolo, suppenkelle
N	0464	CUCHARA ENSALADA salad spoon, cuillère à servir salade, cucchiaio servire, salatlöffel
O	0465	TENEDOR ENSALADA salad fork, fourchette à servir salade, forchetta servire, salatgabel
P	0466	PALA REPOSTERÍA cake server, pelle à tarte, pala torta, tortenheber
Q	0467	CAZO SALSA sauce ladle, cuillère à sauce, mestolino salsa, soßenkelle
	9804	16 PIEZAS 16 pieces, écrin 16 pièces, bauletto 16 pz., 16 Stück
	2900	24 PIEZAS 24 pieces, écrin 24 pièces, bauletto 24 pz., 24 Stück
	8714	30 PIEZAS 30 pieces, écrin 30 pièces, bauletto 30 pz., 30 Stück

€	UE	MOQ	▶ mm	✂ mm
3,36 €	0/12/120/1920/5760	60	229	
3,18 €	0/12/120/1440/7200	60	205	3,5
3,18 €	0/12/120/1440/7200	60	205	3,5
2,87 €	0/12/120/1440/7200	60	215	3,5
2,87 €	0/12/120/1440/7200	60	195	3,5
2,44 €	0/12/120/1920/5760	60	200	
2,87 €	0/12/120/1440/7200	60	190	3,5
2,87 €	0/12/120/1440/7200	60	185	3,5
1,89 €	0/12/120/2520/15120	60	140	2,5
1,89 €	0/12/120/2520/15120	60	147	2,5
1,54 €	0/12/120/2520/15120	60	110	2
2,95 €	0/12/120/1440/7200	60	180	2,5
13,22 €	1/10/50/150/750	10	280	3,5
9,06 €	1/10/50/800/4000	10	275	3,5
9,06 €	1/10/50/800/4000	10	275	3,5
6,76 €	1/10/50/600/2400	10	260	3,5
10,90 €	1/10/50/800/4000	10	180	3,5
50,75 €	1/0/4/56/112	4		3,5
76,15 €	1/0/4/56/112	4		3,5
85,84 €	1/0/4/56/112	4		3,5



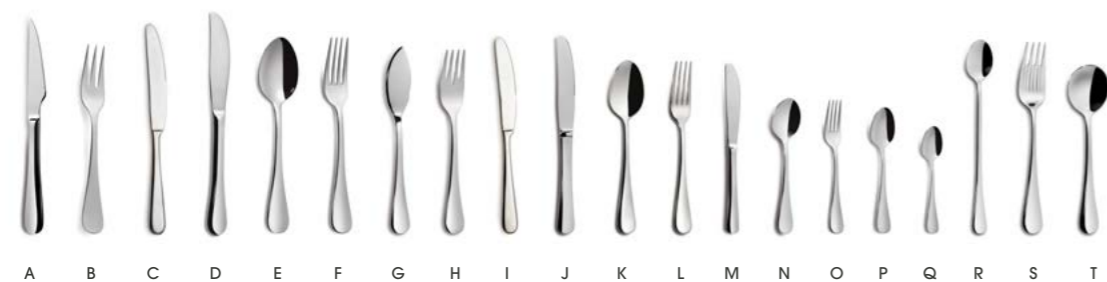

	€	UE	MOQ	✂ mm	✂ mm
A 4402 CUCHILLO CHULETERO table knife, couteau table, coltello tavola, tafelmesser	3,19 €	0/12/120/1920/5760	60	228	
B 5525 TENEDOR CHULETERO steak fork, fourchette steak, forchetta bistecca, steakgabel	2,85 €	0/12/120/1440/7200	60	202	3
C 8593 CUCHILLO MESA RK RK table knife, couteau table RK, coltello tavola RK, RK tafelmesser	3,91 €	0/12/120/1920/5760	60	224	10
D 4535 CUCHILLO MESA table knife, couteau table, coltello tavola, tafelmesser	3,19 €	0/12/120/1920/5760	60	240	
E 4536 CUCHARA MESA table spoon, cuillère table, cucchiaino tavola, tafellöffel	2,87 €	0/12/120/1440/7200	60	210	3
F 4537 TENEDOR MESA table fork, fourchette table, forchetta tavola, tafelgabel	2,87 €	0/12/120/1440/7200	60	210	3
G 5376 PALA PESCADO fish knife, couteau poisson, coltello pesce, fischmesser	2,58 €	0/12/120/1440/7200	60	200	3
H 5377 TENEDOR PESCADO fish fork, fourchette poisson, forchetta pesce, fischgabel	2,76 €	0/12/120/1440/7200	60	195	3
I 8594 CUCHILLO POSTRE RK RK dessert knife, couteau dessert RK, coltello frutta RK, RK dessertmesser	3,34 €	0/12/120/1920/5760	60	210	8,5
J 4538 CUCHILLO POSTRE dessert knife, couteau dessert, coltello frutta, dessertmesser	2,83 €	0/12/120/1920/5760	60	212	
K 5378 CUCHARA POSTRE dessert spoon, cuillère dessert, cucchiaino frutta, dessertlöffel	2,47 €	0/12/120/1440/7200	60	185	2,5
L 5379 TENEDOR POSTRE dessert fork, fourchette dessert, forchetta frutta, dessertgabel	2,47 €	0/12/120/1440/7200	60	185	2,5
M 5015 CUCHILLO LUNCH cake knife, couteau gâteau, coltello dolce, kuchenmesser	2,63 €	0/12/120/1920/5760	60	178	
N 3846 CUCHARA TÉ iced tea spoon, cuillère à té, cucchiaino the, cocktaillöffel	1,64 €	0/12/120/2520/15120	60	145	2
O 5566 TENEDOR LUNCH cake fork, fourchette gâteau, forchetta dolce, kuchengabel	1,57 €	0/12/120/2520/15120	60	145	2
P 3948 CUCHARA CAFÉ tea spoon, cuillère café, cucchiaino caffè, koffeellöffel	1,57 €	0/12/120/2520/15120	60	135	2
Q 3949 CUCHARA MOKA coffee/moka spoon, cuillère moka, cucchiaino moka, mokkalöffel	1,39 €	0/12/120/2520/15120	60	115	2
R 4993 CUCHARA REFRESCO soda spoon, cuillère mazagran, cucchiaino bibita, longdrinklöffel	2,11 €	0/12/120/1440/7200	60	207	2
S 5533 TENEDOR ARROZ rice fork, fourchette à riz, forchetta riso, reisgabel	2,92 €	0/12/120/1440/7200	60	205	2,5
T 3154 CUCHARA CONSOMÉ consommé spoon, cuillère consommé, cucchiaino zuppa, bouillonlöffel	2,79 €	0/12/120/1440/7200	60	180	2,5



	€	UE	MOQ	✂ mm	✂ mm
9809 16 PIEZAS 16 pieces, écrin 16 pièces, bauletto 16 pz., 16 stück	44,97 €	1/0/4/56/112	4		3
7119 24 PIEZAS 24 pieces, écrin 24 pièces, bauletto 24 pz., 24 stück	67,62 €	1/0/4/56/112	4		3
8719 30 PIEZAS 30 pieces, écrin 30 pièces, bauletto 30 pz., 30 stück	76,09 €	1/0/4/56/112	4		3



North M

INOX 18/10 / 2,5mm / Mirror



	€	UE	MOQ	▶ mm	✂ mm
A 6359 CUCHILLO MESA GRANDE long table knife, grande couteau table, coltello tavola grande, tafelmesser lang	2,49 €	0/12/120/1920/5760	60	228	
B 4007 CUCHARA MESA GRANDE table spoon, grande cuillère table, cucchiaio tavola grande, tafellöffel lang	1,99 €	0/12/120/1440/7200	60	198	2,5
C 4008 TENEDOR MESA GRANDE long table fork, grande fourchette table, forchetta tavola grande, tafelgabel lang	1,99 €	0/12/120/1440/7200	60	198	2,5
D 3948 CUCHARA CAFÉ tea spoon, cuillère café, cucchiaio caffè, kaffeelöffel	1,57 €	0/12/120/2520/15120	60	135	2,5
9810 16 PIEZAS 16 pieces, écrin 16 pièces, bauletto 16 pz., 16 stück	31,93 €	1/0/4/56/112	4		2,5
7120 24 PIEZAS 24 pieces, écrin 24 pièces, bauletto 24 pz., 24 stück	53,56 €	1/0/4/56/112	4		2,5
8720 30 PIEZAS 30 pieces, écrin 30 pièces, bauletto 30 pz., 30 stück	56,65 €	1/0/4/56/112	4		2,5



North S

INOX 18/10 / 2mm / Mirror

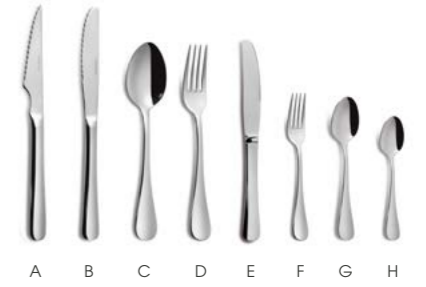

	€	UE	MOQ	▶ mm	✂ mm
A 5631 CUCHILLO CHULETERO steak knife, couteau steak nordic, coltello bistecca nordic, nordic steakmesser	2,36 €	0/12/120/1920/5760	60	230	
B 0094 CUCHILLO MESA table knife, couteau table, coltello tavola, tafelmesser	2,36 €	0/12/120/1920/5760	60	225	
C 3940 CUCHARA MESA table spoon, cuillère table, cucchiaio tavola, tafellöffel	1,59 €	0/12/120/1440/7200	60	193	1,8
D 3941 TENEDOR MESA table knife, couteau table, coltello tavola, tafelmesser	1,59 €	0/12/120/1440/7200	60	190	2
E 0099 CUCHILLO POSTRE dessert knife, couteau dessert, coltello frutta, dessertmesser	1,99 €	0/12/120/1920/5760	60	195	
F 3947 TENEDOR LUNCH cake fork, fourchette gâteau, forchetta dolce, kuchengabel	0,87 €	0/12/120/2520/15120	60	143	1,5
G 5567 CUCHARA CAFÉ tea spoon, cuillère café, cucchiaio caffè, kaffeelöffel	0,87 €	0/12/120/2520/15120	60	140	1,5
H 5568 CUCHARA MOKA coffee/moka spoon, cuillère moka, cucchiaio moka, mokkalöffel	0,79 €	0/12/120/2520/15120	60	120	1,2
9811 16 PIEZAS 16 pieces, écrin 16 pièces, bauletto 16 pz., 16 stück	27,96 €	1/0/4/56/112	4		2
7122 24 PIEZAS 24 pieces, écrin 24 pièces, bauletto 24 pz., 24 stück	43,26 €	1/0/4/56/112	4		2
8721 30 PIEZAS 30 pieces, écrin 30 pièces, bauletto 30 pz., 30 stück	47,99 €	1/0/4/56/112	4		2



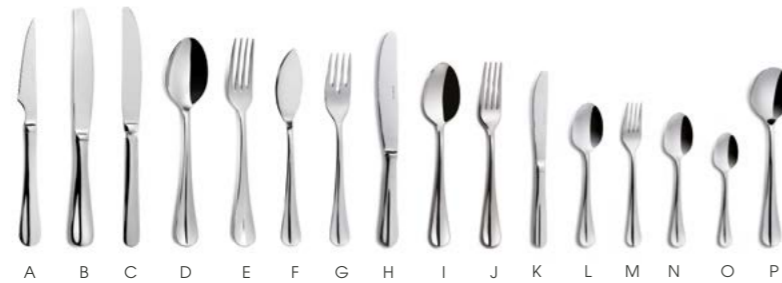

	€	UE	MOQ	✂ mm	✂ mm
A 3526 CUCHILLO CHULETERO steak knife, couteau steak, coltello bistecca, steakmesser	3,20 €	0/12/120/1920/5760	60	230	
B 5013 CUCHILLO MESA table knife, couteau table, coltello tavola, tafelmesser	3,21 €	0/12/120/1920/5760	60	240	
C 2815 CUCHILLO MESA LISO table knife, couteau table, coltello tavola, tafelmesser	3,36 €	0/12/120/1920/5760	60	240	
D 4365 CUCHARA MESA table spoon, cuillère table, cucchiaio tavola, tafellöffel	2,87 €	0/12/120/1440/7200	60	210	3
E 4366 TENEDOR MESA table fork, fourchette table, forchetta tavola, tafelgabel	2,87 €	0/12/120/1440/7200	60	210	3
F 5297 PALA PESCADO fish knife, couteau poisson, coltello pesce, fischmesser	2,58 €	0/12/120/1440/7200	60	200	2,5
G 5298 TENEDOR PESCADO fish fork, fourchette poisson, forchetta pesce, fischgabel	2,58 €	0/12/120/1440/7200	60	195	2,5
H 4367 CUCHILLO POSTRE dessert knife, couteau dessert, coltello frutta, dessertmesser	2,83 €	0/12/120/1920/5760	60	216	
I 5299 CUCHARA POSTRE dessert spoon, cuillère dessert, cucchiaio frutta, dessertlöffel	2,47 €	0/12/120/1440/7200	60	185	2,5
J 5300 TENEDOR POSTRE dessert fork, fourchette dessert, forchetta frutta, dessertgabel	2,47 €	0/12/120/1440/7200	60	185	2,5
K 5014 CUCHILLO LUNCH cake knife, couteau gâteau, coltello dolce, kuchenmesser	2,63 €	0/12/120/1920/5760	60	178	
L 3877 CUCHARA TÉ iced tea spoon, cuillère à té, cucchiaio the, cocktaillöffel	1,65 €	0/12/120/2520/15120	60	145	2
M 5301 TENEDOR LUNCH cake fork, fourchette gâteau, forchetta dolce, kuchengabel	1,53 €	0/12/120/2520/15120	60	145	2
N 5302 CUCHARA CAFÉ tea spoon, cuillère café, cucchiaio caffè, kaffeelöffel	1,53 €	0/12/120/2520/15120	60	135	2
O 5303 CUCHARA MOKA coffee/moka spoon, cuillère moka, cucchiaio moka, mokkalöffel	1,39 €	0/12/120/2520/15120	60	115	2
P 3155 CUCHARA CONSOMÉ consommé spoon, cuillère consommé, cucchiaio zuppa, bouillonlöffel	2,79 €	0/12/120/1440/7200	60	180	2,5



	€	UE	MOQ	✂ mm	✂ mm
9812 16 PIEZAS 16 pieces, écriin 16 pièces, bauletto 16 pz., 16 Stück	44,97 €	1/0/4/56/112	4		3
4883 24 PIEZAS 24 pieces, écriin 24 pièces, bauletto 24 pz., 24 Stück	67,62 €	1/0/4/56/112	4		3
8722 30 PIEZAS 30 pieces, écriin 30 pièces, bauletto 30 pz., 30 Stück	76,09 €	1/0/4/56/112	4		3



Baguette S

INOX 18/10 / 2mm / Mirror

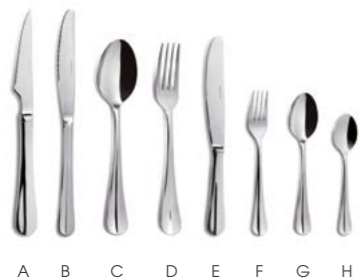

	€	UE	MOQ	▶ mm	Σ mm
A 1283 CUCHILLO CHULETERO steak knife, couteau steak, coltello bistecca, steakmesser	2,36 €	0/12/120/1920/5760	60	223	
B 3522 CUCHILLO MESA table knife, couteau table, coltello tavola, tafelmesser	2,37 €	0/12/120/1920/5760	60	225	
C 4377 CUCHARA MESA table spoon, cuillère table, cucchiaino tavola, tafellöffel	1,60 €	0/12/120/1440/7200	60	193	1,8
D 4378 TENEDOR MESA table fork, fourchette table, forchetta tavola, tafelgabel	1,60 €	0/12/120/1440/7200	60	190	2
E 3523 CUCHILLO POSTRE dessert knife, couteau dessert, coltello frutta, dessertmesser	2,17 €	0/12/120/1920/5760	60	196	
F 4383 TENEDOR LUNCH cake fork, fourchette gâteau, forchetta dolce, kuchengabel	0,87 €	0/12/120/2520/15120	60	143	1,5
G 4384 CUCHARA CAFÉ tea spoon, cuillère café, cucchiaino caffè, kaffeelöffel	0,87 €	0/12/120/2520/15120	60	140	1,5
H 4385 CUCHARA MOKA coffee/moka spoon, cuillère moka, cucchiaino moka, mokkalöffel	0,79 €	0/12/120/2520/15120	60	120	1,2
9813 16 PIEZAS 16 pieces, écriin 16 pièces, bauletto 16 pz., 16 stück	27,96 €	1/0/4/56/112	4		2
7121 24 PIEZAS 24 pieces, écriin 24 pièces, bauletto 24 pz., 24 stück	43,26 €	1/0/4/56/112	4		2
8723 30 PIEZAS 30 pieces, écriin 30 pièces, bauletto 30 pz., 30 stück	47,99 €	1/0/4/56/112	4		2



Fabricación de cubiertos Cutlery manufacturing

1 Bobina ACERO INOXIDABLE Stainless steel coil

Material con el que se inicia la fabricación de los cubiertos.

Material with which the manufacture of cutlery begins.



2 Corte Blanking

Se crea una forma geométrica plana (o "pieza en blanco") al introducir la bobina en una prensa y un troquel.

A geometric shape (or "blank") is created by feeding a coil of sheet metal into a press and die.



3 Laminación Rolling

Proceso de rebaje hasta conseguir el grosor y forma correcta al pasar entre rodillos que giran en dirección opuesta.

The process of trimming to the correct thickness and shape by passing between rollers rotating in the opposite direction.



4 Recorte Cutting

Proceso de corte donde se separa la pieza de chapa aplicando una fuerza grande para provocar la rotura del material.

Cutting process where the piece of sheet metal is separated by applying a large force to cause the material to break.



5 Embutición Embossing

Proceso de estampado para producir diseños en relieve o hundidos o relieves en chapa.

Stamping process to produce embossed or sunken designs or reliefs on sheet metal.



6 Pulido Polished

Proceso de afinado de forma para alisar superficies, eliminar rayones y muescas y escalear la superficie.

Shape refining process to smooth surfaces, remove scratches and indentations, and scale the surface.



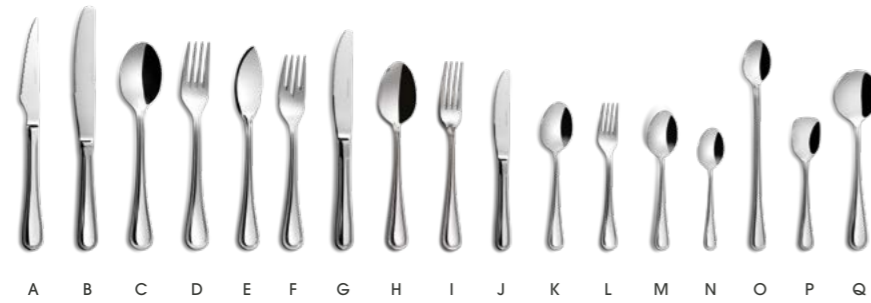

	€	UE	MOQ	✂ mm	✂ mm
A 5952 CUCHILLO CHULETERO steak knife, couteau steak, coltello bistecca, steakmesser	3,21 €	0/12/120/1920/5760	60	228	
B 4362 CUCHILLO MESA table knife, couteau table, coltello tavola, tafelmesser	3,21 €	0/12/120/1920/5760	60	240	
C 4335 CUCHARA MESA table spoon, cuillère table, cucchiaino tavola, tafellöffel	2,60 €	0/12/120/1440/7200	60	205	2,5
D 4336 TENEDOR MESA table fork, fourchette table, forchetta tavola, tafelgabel	2,60 €	0/12/120/1440/7200	60	205	2,5
E 5372 PALA PESCADO fish knife, couteau poisson, coltello pesce, fischmesser	2,56 €	0/12/120/1440/7200	60	200	2,5
F 5373 TENEDOR PESCADO fish fork, fourchette poisson, forchetta pesce, fischgabel	2,47 €	0/12/120/1440/7200	60	195	2,5
G 5012 CUCHILLO POSTRE dessert knife, couteau dessert, coltello frutta, dessertmesser	2,82 €	0/12/120/1920/5760	60	217	
H 5374 CUCHARA POSTRE dessert spoon, cuillère dessert, cucchiaino frutta, dessertlöffel	2,40 €	0/12/120/1440/7200	60	185	2,5
I 5375 TENEDOR POSTRE dessert fork, fourchette dessert, forchetta frutta, dessertgabel	2,40 €	0/12/120/1440/7200	60	185	2,5
J 5038 CUCHILLO LUNCH cake knife, couteau gâteau, coltello dolce, kuchenmesser	2,53 €	0/12/120/1920/5760	60	177	
K 5309 CUCHARA TÉ tea spoon, cuillère à té, cucchiaino the, cocktaillöffel	1,67 €	0/12/120/1440/7200	60	145	2
L 5439 TENEDOR LUNCH cake fork, fourchette gâteau, forchetta dolce, kuchengabel	1,48 €	0/12/120/2520/15120	60	145	2
M 5437 CUCHARA CAFÉ tea spoon, cuillère café, cucchiaino caffè, kaffeelöffel	1,48 €	0/12/120/2520/15120	60	137	2
N 5438 CUCHARA MOKA coffee/moka spoon, cuillère moka, cucchiaino moka, mokkalöffel	1,34 €	0/12/120/2520/15120	60	120	2
O 4508 CUCHARA REFRESCO soda spoon, cuillère mazagran, cucchiaino bibita, longdrinklöffel	2,09 €	0/12/120/1440/7200	60	207	2
P 4018 CUCHARA HELADO ice cream spoon, cuillère à glace, cucchiaino gelato, eiscremelöffel	1,78 €	0/12/120/2520/15120	60	130	2
Q 4019 CUCHARA CONSOMÉ consommé spoon, cuillère consommé, cucchiaino zuppa, bouillonlöffel	2,39 €	0/12/120/1440/7200	60	180	2,5



	€	UE	MOQ	✂ mm	✂ mm
9814 16 PIEZAS 16 pieces, écrin 16 pièces, bauletto 16 pz., 16 stück	38,59 €	1/0/4/56/112	4		2,5
4881 24 PIEZAS 24 pieces, écrin 24 pièces, bauletto 24 pz., 24 stück	67,62 €	1/0/4/56/112	4		2,5
8724 30 PIEZAS 30 pieces, écrin 30 pièces, bauletto 30 pz., 30 stück	71,65 €	1/0/4/56/112	4		2,5



“ Inglés M

INOX 18/10 / 2,5mm / Mirror



“ Inglés S

INOX 18/10 / 2mm / Mirror

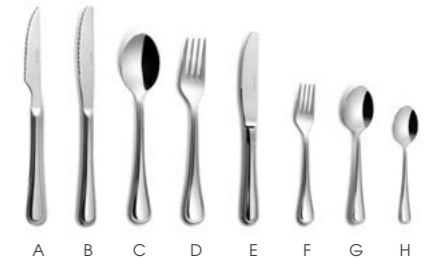

	€	UE	MOQ	▶ mm	✕ mm
A 6360 CUCHILLO MESA GRANDE long table knife, grande couteau table, coltello tavola grande, tafelmesser lang	2,49 €	0/12/120/1920/5760	60	228	
B 4009 CUCHARA MESA GRANDE long table spoon, grande cuillère table, cucchiaio tavola grande, tafellöffel lang	1,99 €	0/12/120/1440/7200	60	198	2,5
C 4010 TENEDOR MESA GRANDE long table fork, grande fourchette table, forchetta tavola grande, tafelgabel lang	1,99 €	0/12/120/1440/7200	60	198	2,5
D 5437 CUCHARA CAFÉ tea spoon, cuillère café, cucchiaio caffè, kaffeelöffel	1,48 €	0/12/120/2520/15120	60	137	2
9815 16 PIEZAS 16 pieces, écrin 16 pièces, bauletto 16 pz., 16 Stück	31,11 €	1/0/4/56/112	4		2,5
7123 24 PIEZAS 24 pieces, écrin 24 pièces, bauletto 24 pz., 24 Stück	51,50 €	1/0/4/56/112	4		2,5
8725 30 PIEZAS 30 pieces, écrin 30 pièces, bauletto 30 pz., 30 Stück	56,65 €	1/0/4/56/112	4		2,5



	€	UE	MOQ	▶ mm	✕ mm
A 2396 CUCHILLO CHULETERO steak knife, couteau steak, coltello bistecca, steakmesser	2,36 €	0/12/120/1920/5760	60	223	
B 2338 CUCHILLO MESA table knife, couteau table, coltello tavola, tafelmesser	2,36 €	0/12/120/1920/5760	60	222	
C 2339 CUCHARA MESA table spoon, cuillère table, cucchiaio tavola, tafellöffel	1,60 €	0/12/120/1440/7200	60	193	1,8
D 2340 TENEDOR MESA table fork, fourchette table, forchetta tavola, tafelgabel	1,60 €	0/12/120/1440/7200	60	190	2
E 2511 CUCHILLO POSTRE dessert knife, couteau dessert, coltello frutta, dessertmesser	1,99 €	0/12/120/1920/5760	60	196	
F 2341 TENEDOR LUNCH cake fork, fourchette gâteau, forchetta dolce, kuchengabel	0,84 €	0/12/120/2520/15120	60	143	1,5
G 2342 CUCHARA CAFÉ tea spoon, cuillère café, cucchiaio caffè, kaffeelöffel	0,84 €	0/12/120/2520/15120	60	140	1,5
H 2343 CUCHARA MOKA coffee/moka spoon, cuillère moka, cucchiaio moka, mokkalöffel	0,79 €	0/12/120/2520/15120	60	120	1,2
9816 16 PIEZAS 16 pieces, écrin 16 pièces, bauletto 16 pz., 16 Stück	27,96 €	1/0/4/56/112	4		2
7124 24 PIEZAS 24 pieces, écrin 24 pièces, bauletto 24 pz., 24 Stück	43,26 €	1/0/4/56/112	4		2
8726 30 PIEZAS 30 pieces, écrin 30 pièces, bauletto 30 pz., 30 Stück	47,99 €	1/0/4/56/112	4		2





		€	UE	MOQ	▶ mm	✂ mm
A	5307 CUCHILLO CHULETERO steak knife, couteau steak, coltello bistecca, steakmesser	3,20 €	0/12/120/1920/5760	60	228	
B	4777 CUCHILLO MESA table knife, couteau table, coltello tavola, tafelmesser	3,20 €	0/12/120/1920/5760	60	240	
C	4714 CUCHARA MESA table spoon, cuillère table, cucchiaio tavola, tafellöffel	2,60 €	0/12/120/1440/7200	60	210	2,5
D	4715 TENEDOR MESA table fork, fourchette table, forchetta tavola, tafelgabel	2,60 €	0/12/120/1440/7200	60	210	2,5
E	4716 PALA PESCADO fish knife, couteau poisson, coltello pesce, fischmesser	2,49 €	0/12/120/1440/7200	60	210	2,5
F	4717 TENEDOR PESCADO fish fork, fourchette poisson, forchetta pesce, fischgabel	2,49 €	0/12/120/1440/7200	60	196	2,5
G	4778 CUCHILLO POSTRE dessert knife, couteau dessert, coltello frutta, dessertmesser	2,82 €	0/12/120/1920/5760	60	210	
H	4721 CUCHARA POSTRE dessert spoon, cuillère dessert, cucchiaio frutta, dessertlöffel	2,39 €	0/12/120/1440/7200	60	191	2,5
I	4722 TENEDOR POSTRE dessert fork, fourchette dessert, forchetta frutta, dessertgabel	2,39 €	0/12/120/1440/7200	60	195	2,5
J	4718 TENEDOR LUNCH cake fork, fourchette gâteau, forchetta dolce, kuchengabel	1,70 €	0/12/120/2520/15120	60	160	2
K	4719 CUCHARA CAFÉ tea spoon, cuillère café, cucchiaio caffè, kaffeelöffel	1,68 €	0/12/120/2520/15120	60	155	2
L	4720 CUCHARA MOKA coffee/moka spoon, cuillère moka, cucchiaio moka, mokkalöffel	1,48 €	0/12/120/2520/15120	60	133	1,8
M	4781 CAZO SOPA soup ladle, louche à potage, mestolo, suppenkelle	10,54 €	1/10/50/150/750	10	280	2,5
N	4780 CUCHARA ENSALADA salad spoon, cuillère à servir salade, cucchiaio servire, salatlöffel	7,05 €	1/10/50/800/4000	10	240	2,5
O	4779 TENEDOR ENSALADA salad fork, fourchette à servir salade, forchetta servire, salatgabel	7,05 €	1/10/50/800/4000	10	240	2,5
P	4784 PALA REPOSTERÍA cake server, pelle à tarte, pala torta, tortenheber	7,24 €	1/10/50/800/2400	10	240	2,5
Q	4783 CAZO SALSA sauce ladle, cuillère à sauce, mestolino salsa, soßenkelle	7,24 €	1/10/50/800/4000	10	170	2,7



		€	UE	MOQ	▶ mm	✂ mm
9818	16 PIEZAS 16 pieces, écrin 16 pièces, bauletto 16 pz., 16 stück	40,18 €	1/0/4/56/112	4		2,5
9817	24 PIEZAS 24 pieces, écrin 24 pièces, bauletto 24 pz., 24 stück	57,86 €	1/0/4/56/112	4		2,5
8727	30 PIEZAS 30 pieces, écrin 30 pièces, bauletto 30 pz., 30 stück	67,48 €	1/0/4/56/112	4		2,5





	€	UE	MOQ	▶ mm	✕ mm
A 6116 CUCHILLO STANDING steak knife, couteau steak, coltello bistecca, steakmesser	6,08 €	0/12/120/1920/5760	60	231	
B 0764 CUCHILLO CHULETERO table knife, couteau table, coltello tavola, tafelmesser	3,36 €	0/12/120/1920/5760	60	223	
C 0268 CUCHILLO MESA table knife, couteau table, coltello tavola, tafelmesser	3,36 €	0/12/120/1920/5760	60	221	
D 5803 CUCHARA MESA table spoon, cuillère table, cucchiaio tavola, tafellöffel	2,80 €	0/12/120/1440/7200	60	200	3
E 5804 TENEDOR MESA table fork, fourchette table, forchetta tavola, tafelgabel	2,80 €	0/12/120/1440/7200	60	200	3
F 5805 PALA PESCADO fish knife, couteau poisson, coltello pesce, fischmesser	2,76 €	0/12/120/1440/7200	60	205	2,5
G 5806 TENEDOR PESCADO fish fork, fourchette poisson, forchetta pesce, fischgabel	2,76 €	0/12/120/1440/7200	60	190	2,5
H 5807 CUCHILLO POSTRE dessert knife, couteau dessert, coltello frutta, dessertmesser	3,15 €	0/12/120/1920/5760	60	202	
I 5808 CUCHARA POSTRE dessert spoon, cuillère dessert, cucchiaio frutta, dessertlöffel	2,76 €	0/12/120/1440/7200	60	183	2,5
J 5809 TENEDOR POSTRE dessert fork, fourchette dessert, forchetta frutta, dessertgabel	2,76 €	0/12/120/1440/7200	60	185	2,5
K 5814 CUCHILLO LUNCH cake knife, couteau gâteau, coltello dolce, kuchenmesser	2,89 €	0/12/120/1920/5760	60	167	
L 5810 TENEDOR LUNCH cake fork, fourchette gâteau, forchetta dolce, kuchengabel	1,67 €	0/12/120/2520/15120	60	140	2,5
M 5811 CUCHARA CAFÉ tea spoon, cuillère café, cucchiaio caffè, koffeelöffel	1,67 €	0/12/120/2520/15120	60	140	2,5
N 5812 CUCHARA MOKA coffee/moka spoon, cuillère moka, cucchiaio moka, makkalöffel	1,52 €	0/12/120/2520/15120	60	110	2,5
O 5815 PALA MANTEQUILLA butter knife, couteau beurre, coltello burro, buttermesser	2,76 €	0/12/120/1440/7200	60	165	2,5
P 3152 CUCHARA REFRESCO soda spoon, cuillère mazagran, cucchiaio bibita, longdrinklöffel	2,16 €	0/12/120/1440/7200	60	200	2,5
Q 3153 CUCHARA CONSOMÉ consommé spoon, cuillère consommé, cucchiaio zuppa, bouillonlöffel	2,80 €	0/12/120/1440/7200	60	180	2,5
R 0470 CAZO SOPA soup ladle, louche à potage, mestalo, suppenkelle	11,39 €	1/10/50/150/750	10	268	3
S 0471 CUCHARA ENSALADA salad spoon, cuillère à servir salade, cucchiaio servire, salatlöffel	7,78 €	1/10/50/800/4000	10	270	3
T 0472 TENEDOR ENSALADA salad fork, fourchette à servir salade, forchetta servire, salatgabel	7,78 €	1/10/50/800/4000	10	265	3
U 0473 PALA LASAÑA lasagna server, pelle à lasagne, pala lasagna, lasagneheber	7,20 €	1/10/50/600/2400	10	235	3
V 0474 CAZO SALSA sauce ladle, cuillère à sauce, mestolino salsa, soßenkelle	5,46 €	1/10/50/800/4000	10	180	3



* CUCHILLO STANDING

	€	UE	MOQ	▶ mm	✕ mm
9808 16 PIEZAS 16 pieces, écriin 16 pièces, bauletto 16 pz., 16 stück	44,97 €	1/0/4/56/112	4		3
5818 24 PIEZAS 24 pieces, écriin 24 pièces, bauletto 24 pz., 24 stück	67,62 €	1/0/4/56/112	4		3
8718 30 PIEZAS 30 pieces, écriin 30 pièces, bauletto 30 pz., 30 stück	76,52 €	1/0/4/56/112	4		3



El concepto RK (Revolution Knife) nace con el objetivo de crear un cuchillo con un diseño único, pensado para poder adaptarlo a diferentes colecciones ya existentes y así modernizar el conjunto dándole un aire actual y diferente.

Nuestros cuchillos RK North XL, RK London y RK London Vintage cogen como base los cuchillos de mesa y postre de estas colecciones y se transforman redibujando sus formas hasta acabar surgiendo un cuchillo totalmente nuevo con el que poder jugar a combinarlos con otras familias de cubiertos COMAS.

Revolution Knife (RK) is fruit of our desire to create a knife with a truly unique design, capable of fitting into existing collections to bring them up to date with a different, contemporary look.

Our knives RK North XL, RK London and RK London Vintage are based on the table and dessert knives from those collections, taking their lines and remoulding them to produce a totally new knife which can be married with other COMAS flatware collections.

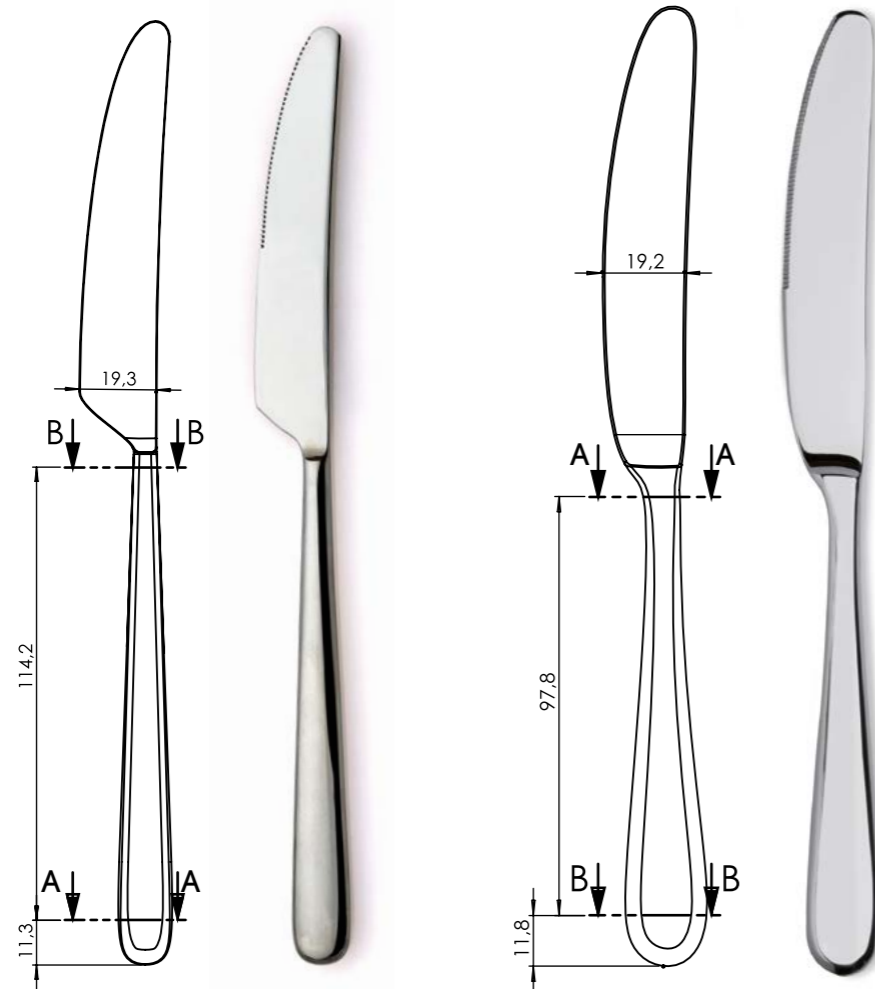

NORTH XL



CHEF



NORTH M



SEVILLA



RK NORTH XL



LONDON



CANADÁ



CUBA



MALVARROSA



RK LONDON



LONDON VINTAGE



SEVILLA VINTAGE



RK LONDON VINTAGE



Bcn Satin



INOX Nickel Free 18%/ 3mm / Satin

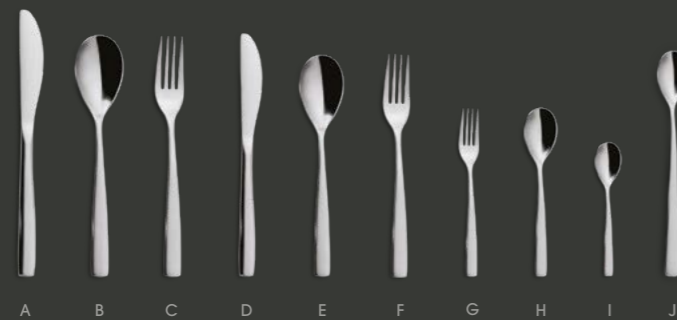

NEW

Bcn Satin

INOX Nickel Free 18% / 3mm / Satin



	€	UE	MOQ	▶ mm	✂ mm
A 6721 CUCHILLO MESA table knife, couteau table, coltello tavola, tafelmesser	2,75 €	1/12/120/1920/5760	120	221	
B 6722 CUCHARA MESA table spoon, cuillère table, cucchiaio tavola, tafellöffel	1,71 €	1/12/120/1440/7200	120	200	3
C 6723 Tenedor MESA table fork, fourchette table, forchetta tavola, tafelgabel	1,71 €	1/12/120/1440/7200	120	200	3
D 6724 CUCHILLO POSTRE dessert knife, couteau dessert, coltello frutta, dessertmesser	2,50 €	1/12/120/1920/5760	120	202	
E 6725 CUCHARA POSTRE dessert spoon, cuillère dessert, cucchiaio frutta, dessertlöffel	1,60 €	1/12/120/1440/7200	120	183	2,5
F 6726 Tenedor POSTRE dessert fork, fourchette dessert, forchetta frutta, dessertgabel	1,60 €	1/12/120/1440/7200	120	185	2,5
G 6727 Tenedor LUNCH cake fork, fourchette gâteau, forchetta dolce, kuchengabel	1,30 €	1/12/120/2520/15120	120	140	2,5
H 6728 CUCHARA CAFÉ tea spoon, cuillère café, cucchiaio caffè, kaffeelöffel	1,30 €	1/12/120/2520/15120	120	140	2,5
I 6729 CUCHARA MOKA coffee/moka spoon, cuillère moka, cucchiaio moka, mokkalöffel	1,27 €	1/12/120/2520/15120	120	110	2,5
J 8378 CUCHARA REFRESCO soda spoon, cuillère mazagan, cucchiaio bibita, longdrinklöffel	1,39 €	1/12/120/1440/7200	60		
NEW 8796 CUCHARA APERITIVO appetizer spoon, cuillère apéritif, cucchiaio antipasto, aperitif löffel	1,92 €	0/6/60/1440/4320	60		3
8232 16 PIEZAS 16 pieces, écrin 16 pièces, bauletto 16 pz., 16 Stück	29,85 €	1/0/4/56/112	4		3
6730 24 PIEZAS 24 pieces, écrin 24 pièces, bauletto 24 pz., 24 Stück	47,60 €	1/0/4/56/112	4		3
8666 30 PIEZAS 30 pieces, écrin 30 pièces, bauletto 30 pz., 30 Stück	57,25 €	1/0/4/56/112	4		3



Bcn Satin Gold

INOX Nickel Free 18% / 3mm / Satin



INOX
NICKEL
FREE
18%



Bcn Satin Copper

INOX Nickel Free 18% / 3mm / Satin



INOX
NICKEL
FREE
18%



	€	UE	MOQ	✂ mm	✂ mm
A 6096 CUCHILLO MESA table knife, couteau table, coltello tavola, tafelmesser	4,05 €	1/12/120/1920/5760	60	221	
B 6097 CUCHARA MESA table spoon, cuillère table, cucchiaio tavola, tafellöffel	3,43 €	1/12/120/1440/7200	60	200	3
C 6098 TENEDOR MESA table fork, fourchette table, forchetta tavola, tafelgabel	3,43 €	1/12/120/1440/7200	60	200	3
D 6350 CUCHILLO POSTRE dessert knife, couteau dessert, coltello frutta, dessertmesser	3,67 €	1/12/120/1920/5760	60	202	
E 6351 CUCHARA POSTRE dessert spoon, cuillère dessert, cucchiaio frutta, dessertlöffel	3,11 €	1/12/120/1440/7200	60	183	2,5
F 6352 TENEDOR POSTRE dessert fork, fourchette dessert, forchetta frutta, dessertgabel	3,11 €	1/12/120/1440/7200	60	185	2,5
G 6099 TENEDOR LUNCH cake fork, fourchette gâteau, forchetta dolce, kuchengabel	2,54 €	1/12/120/2520/15120	60	140	2,5
H 6100 CUCHARA CAFÉ tea spoon, cuillère café, cucchiaio caffè, kaffeelöffel	2,54 €	1/12/120/2520/15120	60	140	2,5
I 6101 CUCHARA MOKA coffee/moka spoon, cuillère moka, cucchiaio moka, makkalöffel	2,33 €	1/12/120/2520/15120	60	110	2,5
J 7551 CUCHARA REFRESCO soda spoon, cuillère mazagran, cucchiaio bibita, longdrinklöffel	2,96 €	1/12/120/1440/7200	60	202	2,5
NEW 8797 CUCHARA APERITIVO appetizer spoon, cuillère apéritif, cucchiaio antipasto, aperitif löffel	3,03 €	0/6/60/1440/4320	60		3
K 7902 CUCHARA ENSALADA salad spoon, cuillère à servir salade, cucchiaio servire, salatlöffel	5,07 €	1/10/50/800/4000	10	270	3
L 7903 TENEDOR ENSALADA salad fork, fourchette à servir salade, forchetta servire, salatgabel	5,07 €	1/10/50/800/4000	10	265	3
8228 16 PIEZAS 16 pieces, écriin 16 pièces, bauletto 16 pz., 16 stück	54,97 €	1/0/4/56/112	4		3
6324 24 PIEZAS 24 pieces, écriin 24 pièces, bauletto 24 pz., 24 stück	80,55 €	1/0/4/56/112	4		3
8662 30 PIEZAS 30 pieces, écriin 30 pièces, bauletto 30 pz., 30 stück	89,12 €	1/0/4/56/112	4		3

	€	UE	MOQ	✂ mm	✂ mm
A 6108 CUCHILLO MESA table knife, couteau table, coltello tavola, tafelmesser	4,05 €	1/12/120/1920/5760	60	221	
B 6109 CUCHARA MESA table spoon, cuillère table, cucchiaio tavola, tafellöffel	3,43 €	1/12/120/1440/7200	60	200	3
C 6110 TENEDOR MESA table fork, fourchette table, forchetta tavola, tafelgabel	3,43 €	1/12/120/1440/7200	60	200	3
D 6356 CUCHILLO POSTRE dessert knife, couteau dessert, coltello frutta, dessertmesser	3,67 €	1/12/120/1920/5760	60	202	
E 6357 CUCHARA POSTRE dessert spoon, cuillère dessert, cucchiaio frutta, dessertlöffel	3,11 €	1/12/120/1440/7200	60	183	2,5
F 6358 TENEDOR POSTRE dessert fork, fourchette dessert, forchetta frutta, dessertgabel	3,11 €	1/12/120/1440/7200	60	185	2,5
G 6111 TENEDOR LUNCH cake fork, fourchette gâteau, forchetta dolce, kuchengabel	2,54 €	1/12/120/2520/15120	60	140	2,5
H 6112 CUCHARA CAFÉ tea spoon, cuillère café, cucchiaio caffè, kaffeelöffel	2,54 €	1/12/120/2520/15120	60	140	2,5
I 6113 CUCHARA MOKA coffee/moka spoon, cuillère moka, cucchiaio moka, makkalöffel	2,33 €	1/12/120/2520/15120	60	110	2,5
J 7553 CUCHARA REFRESCO soda spoon, cuillère mazagran, cucchiaio bibita, longdrinklöffel	2,96 €	1/12/120/1440/7200	60	202	2,5
NEW 8799 CUCHARA APERITIVO appetizer spoon, cuillère apéritif, cucchiaio antipasto, aperitif löffel	3,03 €	0/6/60/1440/4320	60		3
K 7965 CUCHARA ENSALADA salad spoon, cuillère à servir salade, cucchiaio servire, salatlöffel	5,07 €	1/10/50/800/4000	10	270	3
L 7966 TENEDOR ENSALADA salad fork, fourchette à servir salade, forchetta servire, salatgabel	5,07 €	1/10/50/800/4000	10	265	3
8230 16 PIEZAS 16 pieces, écriin 16 pièces, bauletto 16 pz., 16 stück	54,97 €	1/0/4/56/112	4		3
6325 24 PIEZAS 24 pieces, écriin 24 pièces, bauletto 24 pz., 24 stück	82,19 €	1/0/4/56/112	4		3
8664 30 PIEZAS 30 pieces, écriin 30 pièces, bauletto 30 pz., 30 stück	89,12 €	1/0/4/56/112	4		3

Bcn Satin Champagne

INOX Nickel Free 18% / 3mm / Satin



		€	UE	MOQ	✂ mm	✂ mm
A	6711 CUCHILLO MESA table knife, couteau table, cattello tavola, tafelmesser	4,05 €	1/12/120/1920/5760	60	221	
B	6712 CUCHARA MESA table spoon, cuillère table, cucchiaio tavola, tafellöffel	3,43 €	1/12/120/1440/7200	60	200	3
C	6713 TENEDOR MESA table fork, fourchette table, forchetta tavola, tafelgabel	3,43 €	1/12/120/1440/7200	60	200	3
D	6714 CUCHILLO POSTRE dessert knife, couteau dessert, cattello frutta, dessertmesser	3,67 €	1/12/120/1920/5760	60	202	
E	6715 CUCHARA POSTRE dessert spoon, cuillère dessert, cucchiaio frutta, dessertlöffel	3,11 €	1/12/120/1440/7200	60	183	2,5
F	6716 TENEDOR POSTRE dessert fork, fourchette dessert, forchetta frutta, dessertgabel	3,11 €	1/12/120/1440/7200	60	185	2,5
G	6717 TENEDOR LUNCH cake fork, fourchette gâteau, forchetta dolce, kuchengabel	2,54 €	1/12/120/2520/15120	60	140	2,5
H	6718 CUCHARA CAFE tea spoon, cuillère café, cucchiaio caffè, kaffeelöffel	2,54 €	1/12/120/2520/15120	60	140	2,5
I	6719 CUCHARA MOKA coffee/moka spoon, cuillère moka, cucchiaio moka, mokkalöffe	2,33 €	1/12/120/2520/15120	60	110	2,5
J	7899 CUCHARA REFRESCO soda spoon, cuillère mazagran, cucchiaio bibita, longdrinklöffel	2,96 €	1/12/120/1440/7200	60	202	2,5
K	7900 CUCHARA ENSALADA salad spoon, cuillère à servir salade, cucchiaio servire, salatlöffel	5,07 €	1/10/50/800/4000	10	270	3
L	7901 TENEDOR ENSALADA salad fork, fourchette à servir salade, forchetta servire, salatgabel	5,07 €	1/10/50/800/4000	10	265	3
	8231 16 PIEZAS 16 pieces, écriin 16 pièces, bauletto 16 pz., 16 Stück	54,97 €	1/0/4/56/112	4		3
	6720 24 PIEZAS 24 pieces, écriin 24 pièces, bauletto 24 pz., 24 Stück	82,19 €	1/0/4/56/112	4		3
	8665 30 PIEZAS 30 pieces, écriin 30 pièces, bauletto 30 pz., 30 Stück	89,12 €	1/0/4/56/112	4		3

Bcn Satin Black

INOX Nickel Free 18% / 3mm / Satin



		€	UE	MOQ	✂ mm	✂ mm
A	6102 CUCHILLO MESA table knife, couteau table, cattello tavola, tafelmesser	4,05 €	1/12/120/1920/5760	60	221	
B	6103 CUCHARA MESA table spoon, cuillère table, cucchiaio tavola, tafellöffel	3,43 €	1/12/120/1440/7200	60	200	3
C	6104 TENEDOR MESA table fork, fourchette table, forchetta tavola, tafelgabel	3,43 €	1/12/120/1440/7200	60	200	3
D	6353 CUCHILLO POSTRE dessert knife, couteau dessert, cattello frutta, dessertmesser	3,67 €	1/12/120/1920/5760	60	202	
E	6354 CUCHARA POSTRE dessert spoon, cuillère dessert, cucchiaio frutta, dessertlöffel	3,11 €	1/12/120/1440/7200	60	183	2,5
F	6355 TENEDOR POSTRE dessert fork, fourchette dessert, forchetta frutta, dessertgabel	3,11 €	1/12/120/1440/7200	60	185	2,5
G	6105 TENEDOR LUNCH cake fork, fourchette gâteau, forchetta dolce, kuchengabel	2,54 €	1/12/120/2520/15120	60	140	2,5
H	6106 CUCHARA CAFE tea spoon, cuillère café, cucchiaio caffè, kaffeelöffel	2,54 €	1/12/120/2520/15120	60	140	2,5
I	6107 CUCHARA MOKA coffee/moka spoon, cuillère moka, cucchiaio moka, mokkalöffe	2,33 €	1/12/120/2520/15120	60	110	2,5
J	7552 CUCHARA REFRESCO soda spoon, cuillère mazagran, cucchiaio bibita, longdrinklöffel	2,96 €	1/12/120/1440/7200	60	202	2,5
	NEW 8798 CUCHARA APERITIVO appetizer spoon, cuillère apéritif, cucchiaio antipasto, aperitif löffel	3,03 €	0/6/60/1440/4320	60		3
K	7963 CUCHARA ENSALADA salad spoon, cuillère à servir salade, cucchiaio servire, salatlöffel	5,07 €	1/10/50/800/4000	10	270	3
L	7964 TENEDOR ENSALADA salad fork, fourchette à servir salade, forchetta servire, salatgabel	5,07 €	1/10/50/800/4000	10	265	3
	8229 16 PIEZAS 16 pieces, écriin 16 pièces, bauletto 16 pz., 16 Stück	54,97 €	1/0/4/56/112	4		3
	6323 24 PIEZAS 24 pieces, écriin 24 pièces, bauletto 24 pz., 24 Stück	82,19 €	1/0/4/56/112	4		3
	8663 30 PIEZAS 30 pieces, écriin 30 pièces, bauletto 30 pz., 30 Stück	89,12 €	1/0/4/56/112	4		3

INOX
NICKEL
FREE
18%



7967 24 PIEZAS
24 pièces, écriin 24 pièces, bauletto 24 pz., 24 stück

€ 42,22 €

UE 1/0/4/56/112

MOQ 4 ✂ mm 221 ✂ mm 2,5



INOX
NICKEL
FREE
18%

	€	UE	MOQ	✂ mm	✂ mm
A 1335 CUCHILLO MESA table knife, couteau table, coltello tavola, tafelmesser	3,15 €	0/12/120/1920/5760	120	225	
B 1336 CUCHARA MESA table spoon, cuillère table, cucchiaio tavola, tafellöffel	3,27 €	0/12/120/1440/7200	120	208	7
C 1337 TENEDOR MESA table fork, fourchette table, forchetta tavola, tafelgabel	3,27 €	0/12/120/1440/7200	120	208	7
D 2568 TENEDOR LUNCH cake fork, fourchette gâteau, forchetta dolce, kuchengabel	2,40 €	0/12/120/2520/15120	120	150	5,5
E 1338 CUCHARA CAFÉ tea spoon, cuillère café, cucchiaio caffè, kaffeelöffel	2,40 €	0/12/120/2520/15120	120	145	5,5
F 2569 CUCHARA MOKA coffee/moka spoon, cuillère moka, cucchiaio moka, mokkalöffe	2,07 €	0/12/120/2520/15120	120	120	4,5
8223 16 PIEZAS 16 pièces, écriin 16 pièces, bauletto 16 pz., 16 stück	42,47 €	1/0/4/56/112	4		7
0298 24 PIEZAS 24 pièces, écriin 24 pièces, bauletto 24 pz., 24 stück	85,83 €	1/0/4/56/112	4		7
8657 30 PIEZAS 30 pièces, écriin 30 pièces, bauletto 30 pz., 30 stück	97,47 €	1/0/4/56/112	4		7





Malvarrosa



INOX Nickel Free 18% / 4mm / Mirror

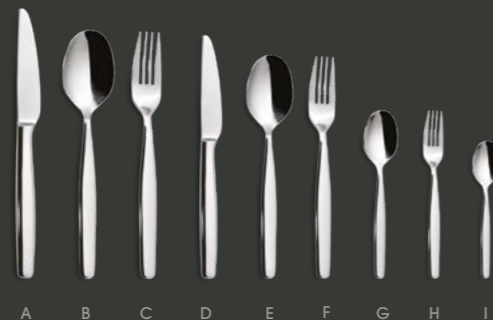

Malvarrosa

INOX Nickel Free 18% / 4mm / Mirror



	€	UE	MOQ	✂ mm	✂ mm
A 6573 CUCHILLO MESA table knife, couteau table, coltello tavola, tafelmesser	2,72 €	0/12/120/1920/5760	120	225	
B 6574 CUCHARA MESA table spoon, cuillère table, cucchiaio tavola, tafellöffel	2,06 €	0/12/120/1440/7200	120	206	4
C 6575 TENEDOR MESA table fork, fourchette table, forchetta tavola, tafelgabel	2,06 €	0/12/120/1440/7200	120	206	4
D 6576 CUCHILLO POSTRE dessert knife, couteau dessert, coltello frutta, dessertmesser	2,43 €	0/12/120/1440/7200	120	203	
E 6577 CUCHARA POSTRE dessert spoon, cuillère dessert, cucchiaio frutta, dessertlöffel	1,80 €	0/12/120/1440/7200	120	185	3,5
F 6578 TENEDOR POSTRE dessert fork, fourchette dessert, forchetta frutta, dessertgabel	1,80 €	0/12/120/1440/7200	120	185	3,5
G 6579 CUCHARA CAFÉ tea spoon, cuillère café, cucchiaio caffè, kaffeelöffel	1,18 €	0/12/120/2520/15120	120	140	3
H 6580 TENEDOR LUNCH cake fork, fourchette gâteau, forchetta dolce, kuchengabel	1,18 €	0/12/120/2520/15120	120	140	3
I 6581 CUCHARA MOKA coffee/moka spoon, cuillère moka, cucchiaio moka, mokkalöffe	1,08 €	0/12/120/2520/15120	120	115	3
6582 MAZO 2 CUCHILLO MESA film 2 table knife, film 2 couteau table, film 2 coltello tavola, film 2 tafelmesser	6,92 €	1/0/48/1008/3024	48	225	
6583 MAZO 3 CUCHARA MESA film 3 table spoon, film 3 cuillère table, film 3 cucchiaio tavola, film 3 tafellöffel	6,92 €	1/0/48/1200/3600	48	206	4
6584 MAZO 3 TENEDOR MESA film 3 table fork, film 3 fourchette table, film 3 forchetta tavola, film 3 tafelgabel	6,92 €	1/0/48/1200/3600	48	206	4
6585 MAZO 6 TENEDOR LUNCH film 6 cake fork, film 6 fourchette gâteau, film 6 forchetta dolce, film 6 kuchengabel	6,92 €	1/0/48/1152/4608	48	140	3
6586 MAZO 6 CUCHARA CAFÉ film 6 tea spoon, film 6 cuillère café, film 6 cucchiaio caffè, film 6 kaffeelöffel	6,92 €	1/0/48/1152/4608	48	140	3
6587 MAZO 6 CUCHARA MOKA film 6 coffee/moka spoon, film 6 cuillère moka, film 6 cucchiaio moka, film 6 mokkalöffe	6,92 €	1/0/48/1152/4608	48	115	3
8224 16 PIEZAS 16 pieces, écrin 16 pièces, bauletto 16 pz., 16 Stück	32,45 €	1/0/4/56/112	4	4	4
6588 24 PIEZAS 24 pieces, écrin 24 pièces, bauletto 24 pz., 24 Stück	47,80 €	1/0/4/56/112	4	4	4
8658 30 PIEZAS 30 pieces, écrin 30 pièces, bauletto 30 pz., 30 Stück	53,56 €	1/0/4/56/112	4	4	4



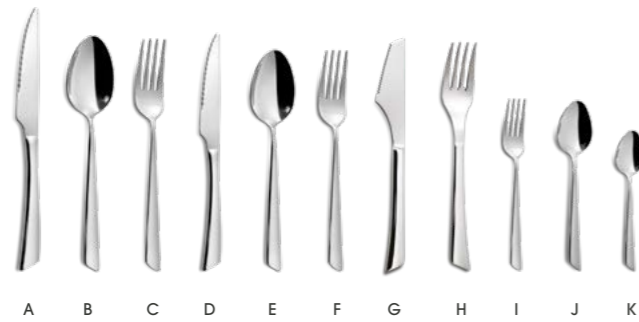

	€	UE	MOQ	▶ mm	✂ mm
A 3197 CUCHILLO CHULETERO steak knife, couteau steak, coltello bistecca, steakmesser	2,62 €	0/12/120/1920/5760	120	233	
B 3198 CUCHARA MESA table spoon, cuillère table, cucchiaio tavola, tafellöffel	1,93 €	0/12/120/1440/7200	120	208	4
C 3199 TENEDOR MESA table fork, fourchette table, forchetta tavola, tafelgabel	1,93 €	0/12/120/1440/7200	120	208	4
D 3200 CUCHILLO POSTRE dessert knife, couteau dessert, coltello frutta, dessertmesser	2,59 €	0/12/120/1920/5760	120	210	
E 3201 CUCHARA POSTRE dessert spoon, cuillère dessert, cucchiaio frutta, dessertlöffel	1,87 €	0/12/120/1440/7200	120	195	4
F 3202 TENEDOR POSTRE dessert fork, fourchette dessert, forchetta frutta, dessertgabel	1,87 €	0/12/120/1440/7200	120	195	4
G 3263 CUCHILLO PIZZA pizza knife, couteau pizza, coltello pizza, pizza tafelmesser	2,63 €	0/12/120/1920/5760	120	205	
H 3264 TENEDOR PIZZA pizza fork, fourchette pizza, forchetta pizza, pizza gabel	2,01 €	0/12/120/1920/5760	120	202	4
I 3203 TENEDOR LUNCH cake fork, fourchette gâteau, forchetta dolce, kuchengabel	1,23 €	0/12/120/2520/15120	120	152	3
J 3204 CUCHARA CAFÉ tea spoon, cuillère café, cucchiaio caffè, kaffeelöffel	1,23 €	0/12/120/2520/15120	120	150	3
K 3205 CUCHARA MOKA coffee/moka spoon, cuillère moka, cucchiaio moka, mokkalöffel	1,18 €	0/12/120/2520/15120	120	125	3
3216 MAZO 2 CUCHILLO CHULETERO film 2 steak knife, film 2 couteau steak, film 2 coltello bistecca, film 2 steakmesser	7,11 €	1/0/48/1008/3024	48	233	
3217 MAZO 3 CUCHARA MESA film 3 table spoon, film 3 cuillère table, film 3 cucchiaio tavola, film 3 tafellöffel	7,11 €	1/0/48/1200/3600	48	208	4
3218 MAZO 3 TENEDOR MESA film 3 table fork, film 3 fourchette table, film 3 forchetta tavola, film 3 tafelgabel	7,11 €	1/0/48/1200/3600	48	208	4
3219 MAZO 2 CUCHILLO POSTRE film 2 dessert knife, film 2 couteau dessert, film 2 coltello frutta, film 2 dessertmesser	7,11 €	1/0/48/1008/3024	48	210	
3220 MAZO 3 CUCHARA POSTRE film 3 dessert spoon, film 3 cuillère dessert, film 3 cucchiaio frutta, film 3 dessertlöffel	7,11 €	1/0/48/1200/3600	48	195	4
3221 MAZO 3 TENEDOR POSTRE film 3 dessert fork, film 3 fourchette dessert, film 3 forchetta frutta, film 3 dessertgabel	7,11 €	1/0/48/1200/3600	48	195	4
3222 MAZO 6 TENEDOR LUNCH film 6 cake fork, film 6 fourchette gâteau, film 6 forchetta dolce, film 6 kuchengabel	7,11 €	1/0/48/1152/4608	48	152	3
3223 MAZO 6 CUCHARA CAFÉ film 6 tea spoon, film 6 cuillère café, film 6 cucchiaio caffè, film 6 kaffeelöffel	7,11 €	1/0/48/1152/4608	48	150	3
3224 MAZO 6 CUCHARA MOKA film 6 coffee/moka spoon, film 6 cuillère moka, film 6 cucchiaio moka, film 6 mokkalöffel	7,11 €	1/0/48/1152/4608	48	125	3



	€	UE	MOQ	▶ mm	✂ mm
8227 16 PIEZAS 16 pieces, écrin 16 pièces, bauletto 16 pz., 16 stück	31,87 €	1/0/4/56/112	4	140	4
3227 24 PIEZAS 24 pieces, écrin 24 pièces, bauletto 24 pz., 24 stück	47,66 €	1/0/4/56/112	4	115	4
8661 30 PIEZAS 30 pieces, écrin 30 pièces, bauletto 30 pz., 30 stück	53,31 €	1/0/4/56/112	4	140	4





Canada

Canada

INOX Nickel Free 18% / 4mm / Mirror



INOX Nickel Free 18% / 4mm / Mirror



A B C D E F G H I J K L M



	€	UE	MOQ	✂ mm	✂ mm
A 6537 CUCHILLO MESA LARGO long table knife, couteau table longue, coltello tavola lungo, lang tafelmesser	2,66 €	0/12/120/1920/5760	120	250	
B 6538 CUCHARA MESA LARGO long table spoon, cuillère table longue, cucchiaio tavola lungo, lang tafellöffel	2,00 €	0/12/120/1440/7200	120	230	4
C 6539 TENEDOR MESA LARGO long table fork, fourchette table longue, forchetta tavola europa lunga, lang tafelgabel	2,00 €	0/12/120/1440/7200	120	228	4
D 6546 CUCHARA CAFÉ LARGO long coffee spoon, cuillère café longue, cucchiaio caffè lungo, lang kaffeelöffel	1,21 €	0/12/120/2520/15120	120	162	3
E 6540 CUCHILLO MESA table knife, couteau table, coltello tavola, tafelmesser	2,52 €	0/12/120/1920/5760	120	233	
F 6541 CUCHARA MESA table spoon, cuillère table, cucchiaio tavola, tafellöffel	1,93 €	0/12/120/1440/7200	120	206	4
G 6542 TENEDOR MESA table fork, fourchette table, forchetta tavola, tafelgabel	1,93 €	0/12/120/1440/7200	120	204	4
H 6543 CUCHILLO POSTRE dessert knife, couteau dessert, coltello frutta, dessertmesser	2,37 €	0/12/120/1920/5760	120	209	
I 6544 CUCHARA POSTRE dessert spoon, cuillère dessert, cucchiaio frutta, dessertlöffel	1,48 €	0/12/120/1440/7200	120	185	3
J 6545 TENEDOR POSTRE dessert fork, fourchette dessert, forchetta frutta, dessertgabel	1,48 €	0/12/120/1440/7200	120	184	3
K 6547 CUCHARA CAFÉ tea spoon, cuillère café, cucchiaio caffè, kaffeelöffel	1,16 €	0/12/120/2520/15120	120	145	3
L 6548 TENEDOR LUNCH cake fork, fourchette gâteau, forchetta dolce, kuchengabel	1,16 €	0/12/120/2520/15120	120	150	3
M 6549 CUCHARA MOKA coffee/moka spoon, cuillère moka, cucchiaio moka, mokkalöffe	0,98 €	0/12/120/2520/15120	120	115	2
6550 MAZO 2 CUCHILLO MESA film 2 table knife, film 2 couteau table, film 2 coltello tavola, film 2 tafelmesser	6,92 €	1/0/48/1008/3024	48	233	
6551 MAZO 3 CUCHARA MESA film 3 table spoon, film 3 cuillère table, film 3 cucchiaio tavola, film 3 tafellöffel	6,92 €	1/0/48/1200/3600	48	206	4
6552 MAZO 3 TENEDOR MESA film 3 table fork, film 3 fourchette table, film 3 forchetta tavola, film 3 tafelgabel	6,92 €	1/0/48/1200/3600	48	204	4
6553 MAZO 6 TENEDOR LUNCH film 6 cake fork, film 6 fourchette gâteau, film 6 forchetta dolce, film 6 kuchengabel	6,92 €	1/0/48/1152/4608	48	150	3
6554 MAZO 6 CUCHARA CAFÉ film 6 tea spoon, film 6 cuillère café, film 6 cucchiaio caffè, film 6 kaffeelöffel	6,92 €	1/0/48/1152/4608	48	145	3
6555 MAZO 6 CUCHARA MOKA film 6 coffee/moka spoon, film 6 cuillère moka, film 6 cucchiaio moka, film 6 mokkalöffe	6,92 €	1/0/48/1152/4608	48	115	2
8225 16 PIEZAS 16 pieces, écriin 16 pièces, bauletto 16 pz., 16 stück	32,45 €	1/0/4/56/112	4	3	
6556 24 PIEZAS 24 pieces, écriin 24 pièces, bauletto 24 pz., 24 stück	47,80 €	1/0/4/56/112	4	3	
8659 30 PIEZAS 30 pieces, écriin 30 pièces, bauletto 30 pz., 30 stück	53,56 €	1/0/4/56/112	4	3	



Canada Vintage

INOX Nickel Free 18% / 4mm / Vintage

NEW

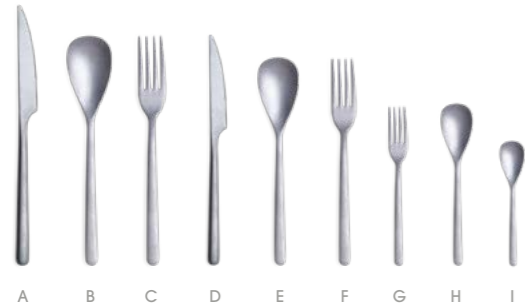

INOX
NICKEL
FREE
18%



INOX
NICKEL
FREE
18%

Canada Vintage Gold

INOX Nickel Free 18% / 4mm / Vintage



	€	UE	MOQ	✂ mm	✂ mm
A 1241 CUCHILLO MESA table knife, couteau table, coltello tavola, tafelmesser	2,85 €	0/12/120/1920/5760	60	233	
B 1242 CUCHARA MESA table spoon, cuillère table, cucchiaio tavola, tafellöffel	2,38 €	0/12/120/1440/7200	60	206	4
C 1243 TENEDOR MESA table fork, fourchette table, forchetta tavola, tafelgabel	2,38 €	0/12/120/1440/7200	60	204	4
D 1244 CUCHILLO POSTRE dessert knife, couteau dessert, coltello frutta, dessertmesser	2,74 €	0/12/120/1920/5760	60	209	
E 1245 CUCHARA POSTRE dessert spoon, cuillère dessert, cucchiaio frutta, dessertlöffel	1,92 €	0/12/120/1440/7200	60	185	3
F 1246 TENEDOR POSTRE dessert fork, fourchette dessert, forchetta frutta, dessertgabel	1,92 €	0/12/120/1440/7200	60	184	3
G 1247 TENEDOR LUNCH cake fork, fourchette gâteau, forchetta dolce, kuchengabel	1,61 €	0/12/120/2520/15120	60	145	3
H 1248 CUCHARA CAFÉ tea spoon, cuillère café, cucchiaio caffè, kaffeelöffel	1,61 €	0/12/120/2520/15120	60	150	3
I 1249 CUCHARA MOKA coffee/moka spoon, cuillère moka, cucchiaio moka, mokkalöffe	1,41 €	0/12/120/2520/15120	60	115	2
8226 16 PIEZAS 16 pieces, écriin 16 pièces, bauletto 16 pz., 16 stück	57,98 €	1/0/4/56/112	4	4	4
1228 24 PIEZAS 24 pieces, écriin 24 pièces, bauletto 24 pz., 24 stück	58,72 €	1/0/4/56/112	4	4	4
8660 30 PIEZAS 30 pieces, écriin 30 pièces, bauletto 30 pz., 30 stück	102,38 €	1/0/4/56/112	4	4	4



	€	UE	MOQ	✂ mm	✂ mm
A 1252 CUCHILLO MESA table knife, couteau table, coltello tavola, tafelmesser	4,38 €	0/12/120/1920/5760	60	233	
B 1253 CUCHARA MESA table spoon, cuillère table, cucchiaio tavola, tafellöffel	3,91 €	0/12/120/1440/7200	60	206	4
C 1254 TENEDOR MESA table fork, fourchette table, forchetta tavola, tafelgabel	3,91 €	0/12/120/1440/7200	60	204	4
D 1255 CUCHILLO POSTRE dessert knife, couteau dessert, coltello frutta, dessertmesser	4,27 €	0/12/120/1920/5760	60	209	
E 1256 CUCHARA POSTRE dessert spoon, cuillère dessert, cucchiaio frutta, dessertlöffel	3,44 €	0/12/120/1440/7200	60	185	3
F 1257 TENEDOR POSTRE dessert fork, fourchette dessert, forchetta frutta, dessertgabel	3,44 €	0/12/120/1440/7200	60	184	3
G 1258 TENEDOR LUNCH cake fork, fourchette gâteau, forchetta dolce, kuchengabel	3,13 €	0/12/120/2520/15120	60	145	3
H 1259 CUCHARA CAFÉ tea spoon, cuillère café, cucchiaio caffè, kaffeelöffel	3,13 €	0/12/120/2520/15120	60	150	3
I 1260 CUCHARA MOKA coffee/moka spoon, cuillère moka, cucchiaio moka, mokkalöffe	2,92 €	0/12/120/2520/15120	60	115	2
8741 16 PIEZAS 16 pieces, écriin 16 pièces, bauletto 16 pz., 16 stück	67,05 €	1/0/4/56/112	4	4	4
1229 24 PIEZAS 24 pieces, écriin 24 pièces, bauletto 24 pz., 24 stück	100,58 €	1/0/4/56/112	4	4	4
8728 30 PIEZAS 30 pieces, écriin 30 pièces, bauletto 30 pz., 30 stück	51,34 €	1/0/4/56/112	4	4	4



Canada Vintage Copper

INOX Nickel Free 18% / 4mm / Vintage



Canada Vintage Black

INOX Nickel Free 18% / 4mm / Vintage



	€	UE	MOQ	✂ mm	✂ mm
A 1270 CUCHILLO MESA table knife, couteau table, coltello tavola, tafelmesser	4,38 €	0/12/120/1920/5760	60	233	
B 1271 CUCCHARA MESA table spoon, cuillère table, cucchiaio tavola, tafelöffel	3,91 €	0/12/120/1440/7200	60	206	4
C 1272 Tenedor MESA table fork, fourchette table, forchetta tavola, tafelgabel	3,91 €	0/12/120/1440/7200	60	204	4
D 1273 CUCHILLO POSTRE dessert knife, couteau dessert, coltello frutta, dessertmesser	4,27 €	0/12/120/1920/5760	60	209	
E 1274 CUCCHARA POSTRE dessert spoon, cuillère dessert, cucchiaio frutta, dessertlöffel	3,44 €	0/12/120/1440/7200	60	185	3
F 1275 Tenedor POSTRE dessert fork, fourchette dessert, forchetta frutta, dessertgabel	3,44 €	0/12/120/1440/7200	60	184	3
G 1276 Tenedor LUNCH cake fork, fourchette gâteau, forchetta dolce, kuchengabel	3,13 €	0/12/120/2520/15120	60	145	3
H 1277 CUCCHARA CAFÉ tea spoon, cuillère café, cucchiaio caffè, kaffeelöffel	3,13 €	0/12/120/2520/15120	60	150	3
I 1278 CUCCHARA MOKA coffee/moka spoon, cuillère moka, cucchiaio moka, mokkalöffe	2,92 €	0/12/120/2520/15120	60	115	2
8763 16 PIEZAS 16 pieces, écriin 16 pièces, bauletto 16 pz., 16 Stück	67,05 €	1/0/4/56/112	4	4	4
1231 24 PIEZAS 24 pieces, écriin 24 pièces, bauletto 24 pz., 24 Stück	100,58 €	1/0/4/56/112	4	4	4
8730 30 PIEZAS 30 pieces, écriin 30 pièces, bauletto 30 pz., 30 Stück	117,88 €	1/0/4/56/112	4	4	4



	€	UE	MOQ	✂ mm	✂ mm
A 1261 CUCHILLO MESA table knife, couteau table, coltello tavola, tafelmesser	4,38 €	0/12/120/1920/5760	60	233	
B 1262 CUCCHARA MESA table spoon, cuillère table, cucchiaio tavola, tafelöffel	3,91 €	0/12/120/1440/7200	60	206	4
C 1263 Tenedor MESA table fork, fourchette table, forchetta tavola, tafelgabel	3,91 €	0/12/120/1440/7200	60	204	4
D 1264 CUCHILLO POSTRE dessert knife, couteau dessert, coltello frutta, dessertmesser	4,27 €	0/12/120/1920/5760	60	209	
E 1265 CUCCHARA POSTRE dessert spoon, cuillère dessert, cucchiaio frutta, dessertlöffel	3,44 €	0/12/120/1440/7200	60	185	3
F 1266 Tenedor POSTRE dessert fork, fourchette dessert, forchetta frutta, dessertgabel	3,44 €	0/12/120/1440/7200	60	184	3
G 1267 Tenedor LUNCH cake fork, fourchette gâteau, forchetta dolce, kuchengabel	3,13 €	0/12/120/2520/15120	60	145	3
H 1268 CUCCHARA CAFÉ tea spoon, cuillère café, cucchiaio caffè, kaffeelöffel	3,13 €	0/12/120/2520/15120	60	150	3
I 1269 CUCCHARA MOKA coffee/moka spoon, cuillère moka, cucchiaio moka, mokkalöffe	2,92 €	0/12/120/2520/15120	60	115	2
8752 16 PIEZAS 16 pieces, écriin 16 pièces, bauletto 16 pz., 16 Stück	67,05 €	1/0/4/56/112	4	4	4
1230 24 PIEZAS 24 pieces, écriin 24 pièces, bauletto 24 pz., 24 Stück	100,58 €	1/0/4/56/112	4	4	4
8729 30 PIEZAS 30 pieces, écriin 30 pièces, bauletto 30 pz., 30 Stück	117,88 €	1/0/4/56/112	4	4	4





Finger Food



INOX Nickel Free 18% / 2mm / Mirror



NEW

Finger Food



INOX Nickel Free 18% / 2mm / Vintage



INOX
NICKEL
FREE
18%

MINI CUBIERTOS PARA EXPERIENCIAS DE GRAN SABOR



Cubertería de diseño propio creada para comidas de servicio rápido.

	€	UE	MOQ	✂ mm	✂ mm	
A 8784 CUCHILLO LUNCH cake knife, couteau gâteau, coltello dolce, kuchenmesser	2,04 €	0/12/120/2520/15120	24	140	6	
B 8786 CUCHARA CAFÉ tea spoon, cuillère café, cucchiaio caffè, kaffeelöffel	0,91 €	0/12/120/2520/15120	24	130	2	
C 8785 TENEDOR LUNCH cake fork, fourchette gâteau, forchetta dolce, kuchengabel	0,91 €	0/12/120/2520/15120	24	130	2	
D 8787 PINCHO TAPAS cocktail stick, stick à cocktail, spiedo, spieb	0,91 €	0/12/120/2520/15120	24	137	2	
8795 PACK 4 PCS 4 pieces, pack 4 pièces, pack 4 pz., 4 pack	5,33 €	1/24/96/576/2880	24		2	



Santorini



INOX Nickel Free 18% / 3,5mm / Mirror

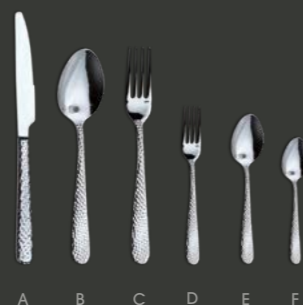

A B C D E F

NEW

Santorini 

INOX Nickel Free 18% / 3mm / Mirror



INOX
NICKEL
FREE
18%

	€	UE	MOQ	✂ mm	✂ mm
A 10642 CUCHILLO MESA table knife, couteau table, coltello tavola, tafelmesser	3,03 €	0//120/1920/5760	120	235	
B 10643 CUCHARA MESA table spoon, cuillère table, cucchiaio tavola, tafellöffel	1,89 €	0//120/1440/7200	120	200	3,5
C 10644 TENEDOR MESA table fork, fourchette table, forchetta tavola, tafelgabel	1,89 €	0//120/1440/7200	120	200	3,5
D 10645 TENEDOR LUNCH cake fork, fourchette gâteau, forchetta dolce, kuchengabel	1,09 €	0//120/2520/15120	120	148	2
E 10646 CUCHARA CAFÉ tea spoon, cuillère café, cucchiaio caffè, kaffeelöffel	1,09 €	0//120/2520/15120	120	140	2
F 10647 CUCHARA MOKA coffee/moka spoon, cuillère moka, cucchiaio moka, mokkalöffe	1,02 €	0//120/2520/15120	120	116	2



Chef Free

INOX Nickel Free 18% / 3,5mm / Mirror



A B C D



- A **5033** CUCHILLO MESA
table knife, couteau table, coltello tavola, tafelmesser
- B **9626** CUCHARA MESA
table spoon, cuillère table, cucchiaio tavola, tafellöffel
- C **9627** TENEDOR MESA
table fork, fourchette table, forchetta tavola, tafelgabel
- D **9628** CUCHARA CAFÉ
tea spoon, cuillère café, cucchiaio caffè, kaffeelöffel

€	UE	MOQ	▶ mm	✂ mm
3,04 €	0/12/120/1920/5760	60	235	
2,01 €	0/12/120/1920/5760	120	200	3,5
2,01 €	0//120/1440/7200	120	200	3,5
1,16 €	0//120/1440/7200	120	140	2
	0//120/2520/15120			



Lotus Free

INOX Nickel Free 18% / 3,5mm / Mirror



A B C D



- A **3139** CUCHILLO MESA
table knife, couteau table, coltello tavola, tafelmesser
- B **9629** CUCHARA MESA
table spoon, cuillère table, cucchiaio tavola, tafellöffel
- C **9630** TENEDOR MESA
table fork, fourchette table, forchetta tavola, tafelgabel
- D **9631** CUCHARA CAFÉ
tea spoon, cuillère café, cucchiaio caffè, kaffeelöffel

€	UE	MOQ	▶ mm	✂ mm
3,60 €	0/12/120/1920/5760	60	225	
1,87 €	0//120/1440/7200	120	211	3,5
1,87 €	0//120/1440/7200	120	211	3,5
1,38 €	0//120/2520/15120	120	139	3,5



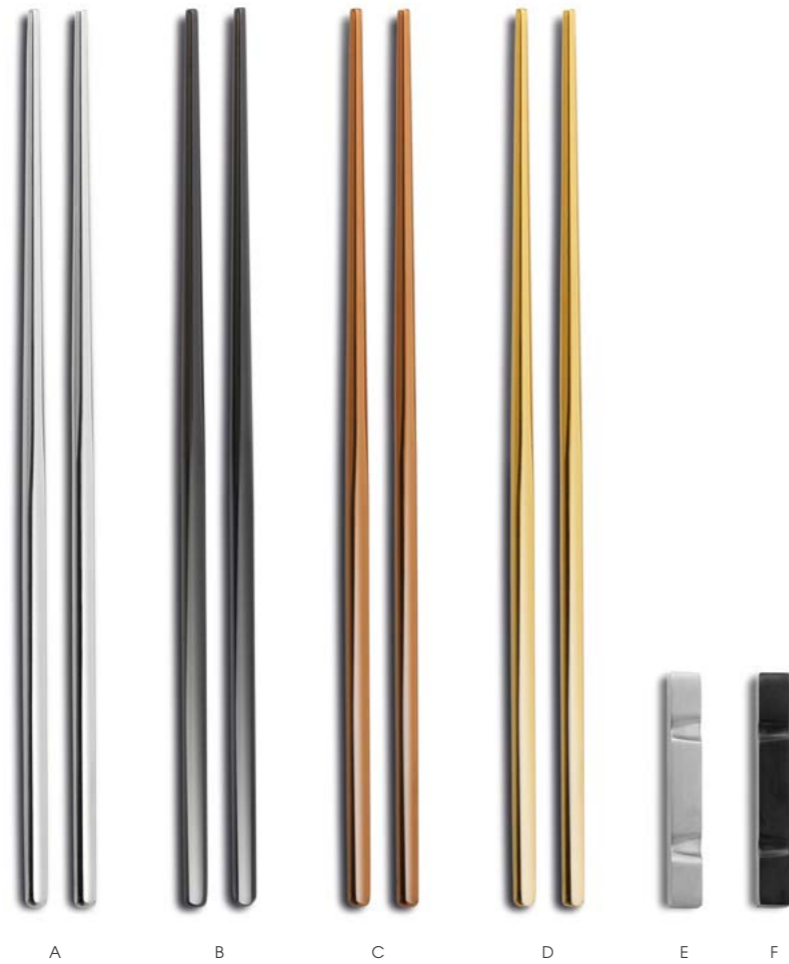

		€	UE	MOQ	✂ mm	✂ mm
A	7421 SET PALILLOS INOX chopsticks set 18/10, set baguettes 18/10, set baguettes 18/10, esst�bchen set 18/10	2,96 €	0/12/120/1920/5760	12	230	11
B	7422 SET PALILLOS BLACK chopsticks set black 18/10, set baguettes black 18/10, set baguettes black 18/10, esst�bchen set 18/10 black	3,40 €	0/12/120/1920/5760	12	230	11
C	7423 SET PALILLOS COPPER chopsticks set copper 18/10, set baguettes copper 18/10, set baguettes copper 18/10, esst�bchen set 18/10 copper	3,40 €	0/12/120/1920/5760	12	230	11
D	7424 SET PALILLOS GOLD chopsticks set gold 18/10, set baguettes gold 18/10, set baguettes gold 18/10, esst�bchen set 18/10 gold	3,40 €	0/12/120/1920/5760	12	230	11
E	7554 REPOSA PALILLOS BLOQUE SATIN chopsticks rest satin 18/10, parte baguette satin 18/10, supporto posate satin 18/10, besteckhalter satin 18/10	3,70 €	0/12/120/1920/5760	12	60	
F	7555 REPOSA PALILLOS BLOQUE NEGRO chopsticks rest black 18/10, parte baguette black 18/10, supporto posate black 18/10, besteckhalter black 18/10	4,44 €	0/12/120/1920/5760	12	60	

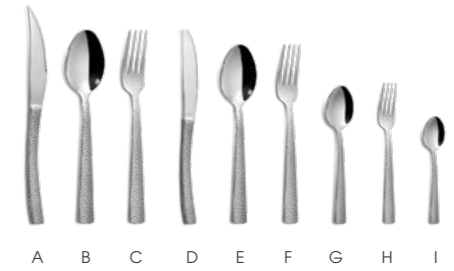

	€	UE	MOQ	✂ mm	✂ mm
A 5610 CUCHILLO CHULETERO steak knife, couteau steak, coltello bistecca, steakmesser	2,56 €	0/12/120/1920/5760	120	225	7
B 5611 CUCHARA MESA table spoon, cuill�re table, cucchiaio tavola, tafell�ffel	1,60 €	0/12/120/1440/7200	120	200	3
C 5612 TENEDOR MESA table fork, fourchette table, forchetta tavola, tafelgabel	1,60 €	0/12/120/1440/7200	120	200	3
D 5615 CUCHILLO POSTRE dessert knife, couteau dessert, coltello frutta, dessertmesser	2,43 €	0/12/120/1920/5760	120	200	
E 5613 CUCHARA POSTRE dessert spoon, cuill�re dessert, cucchiaio frutta, dessertl�ffel	1,52 €	0/12/120/1440/7200	120	184	2
F 5614 TENEDOR POSTRE dessert fork, fourchette dessert, forchetta frutta, dessertgabel	1,52 €	0/12/120/1440/7200	120	184	2
G 5593 CUCHARA CAF� tea spoon, cuill�re caf�, cucchiaio caf�, kaffeel�ffel	0,93 €	0/12/120/2520/15120	120	142	2
H 5595 TENEDOR LUNCH cake fork, fourchette g�teau, forchetta dolce, kuchengabel	0,93 €	0/12/120/2520/15120	120	145	2
I 5594 CUCHARA MOKA coffee/moka spoon, cuill�re moka, cucchiaio moka, mokkal�ffel	0,88 €	0/12/120/2520/15120	120	110	1,8
5616 MAZO 2 CUCHILLO CHULETERO film 2 steak knife, film 2 couteau steak, film 2 coltello bistecca, film 2 steakmesser	5,24 €	1/0/48/1008/3024	48	225	
5617 MAZO 3 CUCHARA MESA film 3 table spoon, film 3 cuill�re table, film 3 cucchiaio tavola, film 3 l�ffel	5,24 €	1/0/48/1200/3600	48	200	3
5618 MAZO 3 TENEDOR MESA film 3 table fork, film 3 fourchette table, film 3 forchetta tavola, film 3 tafelgabel	5,24 €	1/0/48/1200/3600	48	200	3
5619 MAZO 6 TENEDOR LUNCH film 6 cake fork, film 6 fourchette g�teau, film 6 forchetta dolce, film 6 kuchengabel	5,24 €	1/0/48/1152/4608	48	145	2
5620 MAZO 6 CUCHARA CAF� film 6 tea spoon, film 6 cuill�re caf�, film 6 cucchiaio caf�, film 6 kaffeel�ffel	5,24 €	1/0/48/1152/4608	48	142	2
5621 MAZO 6 CUCHARA MOKA film 6 coffee/moka spoon, film 6 cuill�re moka, film 6 cucchiaio moka, film 6 mokkal�ffel	5,24 €	1/0/48/1152/4608	48	110	1,8
8235 16 PIEZAS 16 pieces, �crin 16 pi�ces, bauletto 16 pz., 16 st�ck	26,68 €	1/0/4/56/112	4		2,5
2894 24 PIEZAS 24 pieces, �crin 24 pi�ces, bauletto 24 pz., 24 st�ck	35,47 €	1/0/4/56/112	4		2,5
8668 30 PIEZAS 30 pieces, �crin 30 pi�ces, bauletto 30 pz., 30 st�ck	43,57 €	1/0/4/56/112	4		2,5



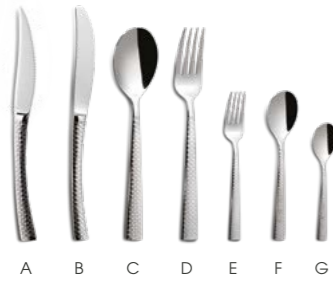

INOX
NICKEL
FREE
18%

INOX
NICKEL
FREE
18%

	€	UE	MOQ	✂ mm	✂ mm
A 6464 CUCHILLO CHULETERO steak knife, couteau steak, coltello bistecca, steakmesser	2,69 €	0/12/120/1920/5760	120	220	
B 6326 CUCHILLO MESA table knife, couteau table, coltello tavola, tafelmesser	2,69 €	0/12/120/1920/5760	120	220	
C 6327 CUCHARA MESA table spoon, cuillère table, cucchiaio tavola, tafellöffel	1,73 €	0/12/120/1440/7200	120	200	3
D 6328 TENEDOR MESA table fork, fourchette table, forchetta tavola, tafelgabel	1,73 €	0/12/120/1440/7200	120	200	3
E 6329 TENEDOR LUNCH cake fork, fourchette gâteau, forchetta dolce, kuchengabel	0,99 €	0/12/120/2520/15120	120	140	2
F 6331 CUCHARA CAFÉ tea spoon, cuillère café, cucchiaio caffè, kaffeelöffel	0,99 €	0/12/120/2520/15120	120	140	2
G 6330 CUCHARA MOKA coffee/moka spoon, cuillère moka, cucchiaio moka, mokkalöffel	0,95 €	0/12/120/2520/15120	120	110	2
6499 MAZO 2 CUCHILLO CHULETERO film 2 steak knife, film 2 couteau steak, film 2 coltello bistecca, film 2 steakmesser	5,37 €	1/0/48/1008/3024	48	220	
6344 MAZO 2 CUCHILLO MESA film 2 table knife, film 2 couteau table, film 2 coltello tavola, film 2 tafelmesser	5,37 €	1/0/48/1008/3024	48	220	
6345 MAZO 3 CUCHARA MESA film 3 table spoon, film 3 cuillère table, film 3 cucchiaio tavola, film 3 tafellöffel	5,37 €	1/0/48/1200/3600	48	200	3
6346 MAZO 3 TENEDOR MESA film 3 table fork, film 3 fourchette table, film 3 forchetta tavola, film 3 tafelgabel	5,37 €	1/0/48/1200/3600	48	200	3
6347 MAZO 6 TENEDOR LUNCH film 6 cake fork, film 6 fourchette gâteau, film 6 forchetta dolce, film 6 kuchengabel	5,37 €	1/0/48/1152/4608	48	140	2
6348 MAZO 6 CUCHARA CAFÉ film 6 tea spoon, film 6 cuillère café, film 6 cucchiaio caffè, film 6 kaffeelöffel	5,37 €	1/0/48/1152/4608	48	140	2
6349 MAZO 6 CUCHARA MOKA film 6 coffee/moka spoon, film 6 cuillère moka, film 6 cucchiaio moka, film 6 mokkalöffel	5,37 €	1/0/48/1152/4608	48	110	2
8233 16 PIEZAS 16 pieces, écriin 16 pièces, bauletto 16 pz., 16 stück	31,53 €	1/0/4/56/112	4	3	
6332 24 PIEZAS 24 pieces, écriin 24 pièces, bauletto 24 pz., 24 stück	43,94 €	1/0/4/56/112	4	3	
8667 30 PIEZAS 30 pieces, écriin 30 pièces, bauletto 30 pz., 30 stück	51,00 €	1/0/4/56/112	4	3	



	€	UE	MOQ	✂ mm	✂ mm
A 7207 CUCHILLO MESA table knife, couteau table, coltello tavola, tafelmesser	4,01 €	0/12/120/1920/5760	60	220	
B 7208 CUCHARA MESA table spoon, cuillère table, cucchiaio tavola, tafellöffel	2,73 €	0/12/120/1440/7200	60	200	3
C 7209 TENEDOR MESA table fork, fourchette table, forchetta tavola, tafelgabel	2,73 €	0/12/120/1440/7200	60	200	3
D 7210 CUCHARA CAFÉ tea spoon, cuillère café, cucchiaio caffè, kaffeelöffel	1,77 €	0/12/120/2520/15120	60	140	2
8234 16 PIEZAS 16 pieces, écriin 16 pièces, bauletto 16 pz., 16 stück	45,27 €	1/0/4/56/112	4	3	
7211 24 PIEZAS 24 pieces, écriin 24 pièces, bauletto 24 pz., 24 stück	73,13 €	1/0/4/56/112	4	3	





	€	UE	MOQ	✂ mm	✂ mm
A 1339 CUCHILLO CHULETERO steak knife, couteau steak, coltello bistecca, steakmesser	2,68 €	0/12/120/1920/5760	120	224	
B 2775 CUCHILLO MESA table knife, couteau table, coltello tavola, tafelmesser	2,68 €	0/12/120/1920/5760	120	221	
C 1340 CUCHARA MESA table spoon, cuillère table, cucchiaio tavola, tafellöffel	1,57 €	0/12/120/1440/7200	120	200	3
D 1341 TENEDOR MESA table fork, fourchette table, forchetta tavola, tafelgabel	1,57 €	0/12/120/1440/7200	120	200	3
E 6114 PALA PESCADO fish knife, couteau poisson, coltello pesce, fischmesser	1,48 €	0/12/120/1440/7200	120	200	3
F 9653 TENEDOR PESCADO fish fork, fourchette poisson, forchetta pesce, fischgabel	1,48 €	0/12/120/1440/7200	120	200	3
G 6115 CUCHILLO POSTRE dessert knife, couteau dessert, coltello frutta, dessertmesser	2,44 €	0/12/120/1920/5760	120	204	
H 1595 CUCHARA POSTRE dessert spoon, cuillère dessert, cucchiaio frutta, dessertlöffel	1,48 €	0/12/120/1440/7200	120	183	3
I 6117 TENEDOR POSTRE dessert fork, fourchette dessert, forchetta frutta, dessertgabel	1,48 €	0/12/120/1440/7200	120	185	3
J 9655 TENEDOR LUNCH cake fork, fourchette gâteau, forchetta dolce, kuchengabel	0,91 €	0/12/120/2520/15120	120	140	2
K 1342 CUCHARA CAFÉ tea spoon, cuillère café, cucchiaio caffè, kaffeelöffel	0,91 €	0/12/120/2520/15120	120	135	2
L 9654 CUCHARA MOKA coffee/moka spoon, cuillère moka, cucchiaio moka, mokkalöffel	0,88 €	0/12/120/2520/15120	120	110	2
M 1619 CAZO SOPA soup ladle, louche à potage, mestolo, suppenkelle	8,03 €	1/10/50/150/750	10	268	3
N 1620 CUCHARA ENSALADA salad spoon, cuillère à servir salade, cucchiaio servire, salatlöffel	4,03 €	1/10/50/800/4000	10	270	3
O 1622 TENEDOR ENSALADA salad fork, fourchette à servir salade, forchetta servire, salatgabel	4,03 €	1/10/50/800/4000	10	265	3
P 1621 PALA LASAÑA lasagna server, pelle à lasagne, pala lasagna, lasagneheber	4,46 €	1/10/50/600/2400	10	235	3
Q 1625 CAZO SALSA sauce ladle, cuillère à sauce, mestolino salsa, saßenkelle	4,46 €	1/10/50/800/4000	10	180	3
1193 MAZO 2 CUCHILLO CHULETERO film 2 steak knife, film 2 couteau steak, film 2 coltello bistecca, film 2 steakmesser	5,02 €	1/0/48/1008/3024	48	224	
1194 MAZO 3 CUCHARA MESA film 3 table spoon, film 3 cuillère table, film 3 cucchiaio tavola, film 3 tafellöffel	5,02 €	1/0/48/1200/3600	48	200	3
1195 MAZO 3 TENEDOR MESA film 3 table fork, film 3 fourchette table, film 3 forchetta tavola, film 3 tafelgabel	5,02 €	1/0/48/1200/3600	48	200	3
1078 MAZO 2 CUCHILLO POSTRE film 2 dessert knife, film 2 couteau dessert, film 2 coltello frutta, film 2 dessertmesser	5,02 €	1/0/48/1008/3024	48	204	
1079 MAZO 3 CUCHARA POSTRE film 3 dessert spoon, film 3 cuillère dessert, film 3 cucchiaio frutta, film 3 dessertlöffel	5,02 €	1/0/48/1200/3600	48	183	3
1080 MAZO 3 TENEDOR POSTRE film 3 dessert fork, film 3 fourchette dessert, film 3 forchetta frutta, film 3 dessertgabel	5,02 €	1/0/48/1200/3600	48	185	3
1196 MAZO 6 TENEDOR LUNCH film 6 cake fork, film 6 fourchette gâteau, film 6 forchetta dolce, film 6 kuchengabel	5,02 €	1/0/48/1152/4608	48	140	2
1197 MAZO 6 CUCHARA CAFÉ film 6 tea spoon, film 6 cuillère café, film 6 cucchiaio caffè, film 6 kaffeelöffel	5,02 €	1/0/48/1152/4608	48	135	2
1198 MAZO 6 CUCHARA MOKA film 6 coffee/moka spoon, film 6 cuillère moka, film 6 cucchiaio moka, film 6 mokkalöffel	5,02 €	1/0/48/1152/4608	48	110	2



	€	UE	MOQ	✂ mm	✂ mm
8236 16 PIEZAS 16 pieces, écriin 16 pièces, bauletto 16 pz., 16 stück	27,40 €	1/0/4/56/112	4		2,5
2895 24 PIEZAS 24 pieces, écriin 24 pièces, bauletto 24 pz., 24 stück	39,50 €	1/0/4/56/112	4		2,5
8669 30 PIEZAS 30 pieces, écriin 30 pièces, bauletto 30 pz., 30 stück	44,44 €	1/0/4/56/112	4		2,5



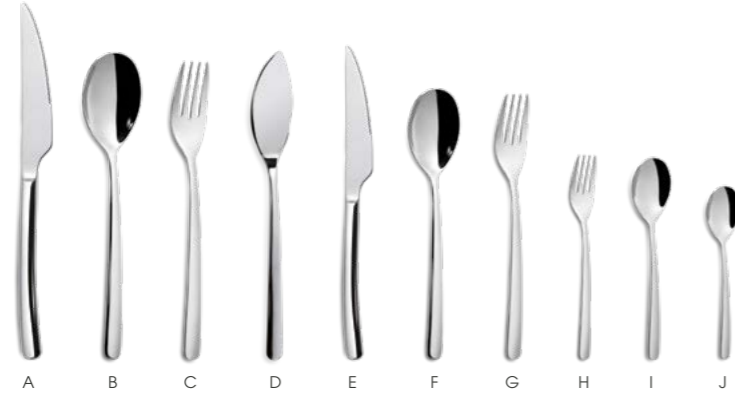

		€	UE	MOQ	✂ mm	✂ mm
A	2283 CUCHILLO MESA table knife, couteau table, coltello tavola, tafelmesser	2,56 €	0/12/120/1920/5760	120	240	
B	2274 CUCHARA MESA table spoon, cuillère table, cucchiaino tavola, tafellöffel	1,57 €	0/12/120/1440/7200	120	200	3
C	2275 TENEDOR MESA table fork, fourchette table, forchetta tavola, tafelgabel	1,57 €	0/12/120/1440/7200	120	200	3
D	2758 PALA PESCADO fish knife, couteau poisson, coltello pesce, fischmesser	1,49 €	0/12/120/1440/7200	120	206	3
E	2284 CUCHILLO POSTRE dessert knife, couteau dessert, coltello frutta, dessertmesser	2,44 €	0/12/120/1920/5760	120	210	
F	2759 CUCHARA POSTRE dessert spoon, cuillère dessert, cucchiaino frutta, dessertlöffel	1,49 €	0/12/120/1440/7200	120	180	3
G	2760 TENEDOR POSTRE dessert fork, fourchette dessert, forchetta frutta, dessertgabel	1,49 €	0/12/120/1440/7200	120	178	3
H	2761 TENEDOR LUNCH cake fork, fourchette gâteau, forchetta dolce, kuchengabel	0,91 €	0/12/120/2520/15120	120	137	2
I	2762 CUCHARA CAFÉ tea spoon, cuillère café, cucchiaino caffè, koffeelöffel	0,91 €	0/12/120/2520/15120	120	134	2
J	2763 CUCHARA MOKA coffee/moka spoon, cuillère moka, cucchiaino moka, mokkalöffel	0,88 €	0/12/120/2520/15120	120	115	2
M2283	MAZO 2 CUCHILLO MESA film 2 table knife, film 2 couteau table, film 2 coltello tavola, film 2 tafelmesser	5,02 €	1/0/48/1008/3024	48	240	
M2274	MAZO 3 CUCHARA MESA film 3 table spoon, film 3 cuillère table, film 3 cucchiaino tavola, film 3 tafellöffel	5,02 €	1/0/48/1200/3600	48	200	3
M2275	MAZO 3 TENEDOR MESA film 3 table fork, film 3 fourchette table, film 3 forchetta tavola, film 3 tafelgabel	5,02 €	1/0/48/1200/3600	48	200	3
M5084	MAZO 2 CUCHILLO POSTRE film 2 dessert knife, film 2 couteau dessert, film 2 coltello frutta, film 2 dessertmesser	5,02 €	1/0/48/1008/3024	48	210	
M2759	MAZO 3 CUCHARA POSTRE film 3 dessert spoon, film 3 cuillère dessert, film 3 cucchiaino frutta, film 3 dessertlöffel	5,02 €	1/0/48/1200/3600	48	180	3
M2760	MAZO 3 TENEDOR POSTRE film 3 dessert fork, film 3 fourchette dessert, film 3 forchetta frutta, film 3 dessertgabel	5,02 €	1/0/48/1200/3600	48	178	3
M2761	MAZO 6 TENEDOR LUNCH film 6 cake fork, film 6 fourchette gâteau, film 6 forchetta dolce, film 6 kuchengabel	5,02 €	1/0/48/1152/4608	48	137	2
M2762	MAZO 6 CUCHARA CAFÉ film 6 tea spoon, film 6 cuillère café, film 6 cucchiaino caffè, film 6 koffeelöffel	5,02 €	1/0/48/1152/4608	48	134	2
M2763	MAZO 6 CUCHARA MOKA film 6 coffee/moka spoon, film 6 cuillère moka, film 6 cucchiaino moka, film 6 mokkalöffel	5,02 €	1/0/48/1152/4608	48	115	2



		€	UE	MOQ	✂ mm	✂ mm
8238	16 PIEZAS 16 pieces, écriin 16 pièces, bauletto 16 pz., 16 stück	27,09 €	1/0/4/56/112	4		2,5
2764	24 PIEZAS 24 pieces, écriin 24 pièces, bauletto 24 pz., 24 stück	39,50 €	1/0/4/56/112	4		2,5
8671	30 PIEZAS 30 pieces, écriin 30 pièces, bauletto 30 pz., 30 stück	43,87 €	1/0/4/56/112	4		2,5



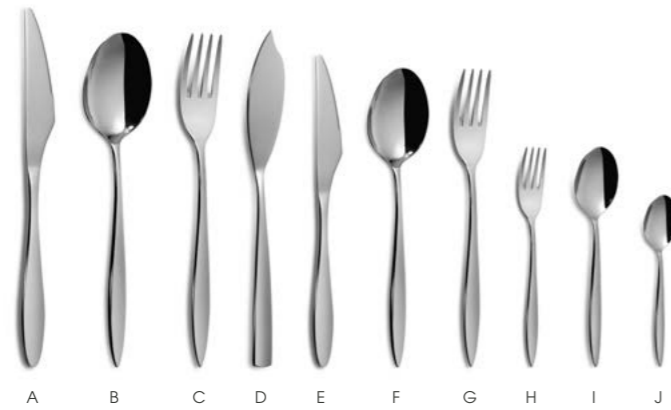

INOX
NICKEL
FREE
18%

	€	UE	MOQ	✂ mm	✂ mm
A 2774 CUCHILLO MESA table knife, couteau table, coltello tavola, tafelmesser	2,56 €	0/12/120/1920/5760	60	229	
B 2710 CUCHARA MESA table spoon, cuillère table, cucchiaio tavola, tafellöffel	1,57 €	0/12/120/1440/7200	120	213	3
C 2711 TENEDOR MESA table fork, fourchette table, forchetta tavola, tafelgabel	1,57 €	0/12/120/1440/7200	120	213	3
D 2734 PALA PESCADO fish knife, couteau poisson, coltello pesce, fischmesser	1,49 €	0/12/120/1440/7200	120	215	2,5
E 5826 CUCHILLO POSTRE dessert knife, couteau dessert, coltello frutta, dessertmesser	2,44 €	0/12/120/1920/5760	60	200	
F 2712 CUCHARA POSTRE dessert spoon, cuillère dessert, cucchiaio frutta, dessertlöffel	1,49 €	0/12/120/1440/7200	120	190	2,5
G 2713 TENEDOR POSTRE dessert fork, fourchette dessert, forchetta frutta, dessertgabel	1,49 €	0/12/120/1440/7200	120	190	2,5
H 2714 TENEDOR LUNCH cake fork, fourchette gâteau, forchetta dolce, kuchengabel	0,91 €	0/12/120/2520/15120	120	140	2
I 2715 CUCHARA CAFÉ tea spoon, cuillère café, cucchiaio caffè, koffeelöffel	0,91 €	0/12/120/2520/15120	120	140	2
J 2716 CUCHARA MOKA coffee/moka spoon, cuillère moka, cucchiaio moka, mokkalöffel	0,88 €	0/12/120/2520/15120	120	109	1,5
M2297 MAZO 2 CUCHILLO MESA film 2 table knife, film 2 couteau table, film 2 coltello tavola, film 2 tafelmesser	5,02 €	1/0/48/1008/3024	48	229	
M2710 MAZO 3 CUCHARA MESA film 3 table spoon, film 3 cuillère table, film 3 cucchiaio tavola, film 3 tafellöffel	5,02 €	1/0/48/1200/3600	48	213	3
M2711 MAZO 3 TENEDOR MESA film 3 table fork, film 3 fourchette table, film 3 forchetta tavola, film 3 tafelgabel	5,02 €	1/0/48/1200/3600	48	213	3
M2161 MAZO 2 CUCHILLO POSTRE film 2 dessert knife, film 2 couteau dessert, film 2 coltello frutta, film 2 dessertmesser	5,02 €	1/0/48/1008/3024	48	200	
M2712 MAZO 3 CUCHARA POSTRE film 3 dessert spoon, film 3 cuillère dessert, film 3 cucchiaio frutta, film 3 dessertlöffel	5,02 €	1/0/48/1200/3600	48	190	2,5
M2713 MAZO 3 TENEDOR POSTRE film 3 dessert fork, film 3 fourchette dessert, film 3 forchetta frutta, film 3 dessertgabel	5,02 €	1/0/48/1200/3600	48	190	2,5
M2714 MAZO 6 TENEDOR LUNCH film 6 cake fork, film 6 fourchette gâteau, film 6 forchetta dolce, film 6 kuchengabel	5,02 €	1/0/48/1152/4608	48	140	2
M2715 MAZO 6 CUCHARA CAFÉ film 6 tea spoon, film 6 cuillère café, film 6 cucchiaio caffè, film 6 koffeelöffel	5,02 €	1/0/48/1152/4608	48	140	2
M2716 MAZO 6 CUCHARA MOKA film 6 coffee/moka spoon, film 6 cuillère moka, film 6 cucchiaio moka, film 6 mokkalöffel	5,02 €	1/0/48/1152/4608	48	109	1,5



	€	UE	MOQ	✂ mm	✂ mm
8237 16 PIEZAS 16 pieces, écriin 16 pièces, bauletto 16 pz., 16 stück	27,09 €	1/0/4/56/112	4		3
2757 24 PIEZAS 24 pieces, écriin 24 pièces, bauletto 24 pz., 24 stück	39,50 €	1/0/4/56/112	4		3
8670 30 PIEZAS 30 pieces, écriin 30 pièces, bauletto 30 pz., 30 stück	43,87 €	1/0/4/56/112	4		3



Reposa cubiertos

Cutlery rest



	€	UE	MOQ	∑ mm	≡ mm
A 7843 REPOSA CUBIERTOS CUADRADO square cutlery rest, repose couverts carré, supporto posate quadrato, quadratische messerablage	1,55 €	0/60/240/3840/11520	6	122	15
B 7844 REPOSA CUBIERTOS PENTAGONAL pentagon cutlery rest, repose couverts pentagonal, supporto posate pentagonale, funkeckige messerablage	1,55 €	0/60/240/3840/11520	6	122	15
C 7841 REPOSA CUBIERTOS CILÍNDRICO round cutlery rest, repose couverts cylindrique, supporto posate tondo, runde messerablage	1,55 €	0/60/240/3840/11520	6	122	15
D 7842 REPOSA CUBIERTOS TRIANGULAR triangle cutlery rest, repose couverts triangulaire, supporto posate triangolare, dreieckige messerablage	1,55 €	0/60/240/3840/11520	6	122	15
E 7554 REPOSA PALILLOS BLOQUE SATIN chopsticks rest satin 18/10, porte baguette satin 18/10, supporto posate satin 18/10, besteckhalter satin 18/10	3,70 €	0/12/120/1920/5760	12	60	8
F 7555 REPOSA PALILLOS BLOQUE NEGRO chopsticks rest black 18/10, porte baguette black 18/10, supporto posate black 18/10, besteckhalter black 18/10	4,44 €	0/12/120/1920/5760	12	60	8
G 7869 SOPORTE CUBIERTOS SAKURA sakura cutlery holder, panier à couverts sakura, supporto coperte sakura, besteckhalter sakura	11,20 €	0/6/60/1440/4320	60	80	15
NEW H 10431 REPOSA CUBIERTOS ATLÁNTIDA atlantida cutlery holder, plateau à couverts atlantida, porta posate atlantida, schneidewagen atlantida	36,52 €	0/4/48/	4	190	80

NEW



Vieux Paris

INOX Nickel Free 18% / 3mm / Mirror + Satin



Acabado mirror
Mirror finish

Acabado sarinado
Satin finish

INOX
NICKEL
FREE
18%

	€	UE	MOQ	≡ mm	∑ mm
A 5795 CUCHILLO MESA table knife, couteau table, coltello tavola, tafelmesser	3,00 €	0//120/1920/5760	60	238	
B 5796 CUCHARA MESA table spoon, cuillère table, cucchiaio tavola, tafellöffel	1,96 €	0//120/1440/7200	60	210	3
C 5797 TENEDOR MESA table fork, fourchette table, forchetta tavola, tafelgabel	1,96 €	0//120/1440/7200	60	208	3
D 5798 CUCHILLO POSTRE dessert knife, couteau dessert, coltello frutta, dessertmesser	2,74 €	0//120/1920/5760	60	215	
E 5799 CUCHARA POSTRE dessert spoon, cuillère dessert, cucchiaio frutta, dessertlöffel	1,49 €	0//120/1440/7200	60	178	2,5
F 5800 TENEDOR POSTRE dessert fork, fourchette dessert, forchetta frutta, dessertgabel	1,49 €	0//120/1440/7200	60	178	2,5
G 5801 CUCHARA CAFÉ tea spoon, cuillère café, cucchiaio caffè, kaffeelöffel	1,08 €	0//120/2520/15120	60	143	2
H 5802 CUCHARA MOKA coffee/moka spoon, cuillère moka, cucchiaio moka, mokkalöffel	0,94 €	0//120/2520/15120	60	112	2





	€	UE	MOQ	▶ mm	✂ mm
A 0094 CUCHILLO MESA table knife, couteau table, coltello tavola, tafelmesser	2,36 €	0/12/120/1920/5760	60	225	
B 5631 CUCHILLO CHULETERO nordic steak knife, couteau steak, coltello bistecca, steakmesser	2,36 €	0/12/120/1920/5760	60	230	
C 9657 CUCHARA MESA table spoon, cuillère table, cucchiaio tavola, tafellöffel	1,70 €	0/12/120/1440/7200	120	205	3
D 9658 TENEDOR MESA table fork, fourchette table, forchetta tavola, tafelgabel	1,70 €	0/12/120/1440/7200	120	205	3
E 9659 PALA PESCADO fish knife, couteau poisson, coltello pesce, fischmesser	1,68 €	0/12/120/1440/7200	120	200	2,5
F 9660 TENEDOR PESCADO fish fork, fourchette poisson, forchetta pesce, fischgabel	1,68 €	0/12/120/1440/7200	120	197	2,5
G 0099 CUCHILLO POSTRE dessert knife, couteau dessert, coltello frutta, dessertmesser	1,99 €	0/12/120/1920/5760	60	195	
H 9662 CUCHARA POSTRE dessert spoon, cuillère à dessert, cucchiaio frutta, dessertlöffel	1,68 €	0/12/120/1440/7200	120	185	2,5
I 9663 TENEDOR POSTRE dessert fork, fourchette à dessert, forchetta frutta, dessertgabel	1,68 €	0/12/120/1440/7200	120	185	2,5
J 9664 TENEDOR LUNCH cake fork, fourchette gâteau, forchetta dolce, kuchengabel	0,92 €	0/12/120/2520/15120	120	145	2
K 9665 CUCHARA CAFÉ tea spoon, cuillère café, cucchiaio caffè, koffeellöffel	0,92 €	0/12/120/2520/15120	120	135	2
L 9666 CUCHARA MOKA coffee/moka spoon, cuillère moka, cucchiaio moka, mokkalöffel	0,89 €	0/12/120/2520/15120	120	115	2
M 1626 CAZO SOPA soup ladle, louche à potage, mestolo, suppenkelle	6,59 €	1/10/50/200/800	10	260	2,5
N 1627 CUCHARA SERVIR serving spoon, cuillère à servir, cucchiaio servir, servierlöffel	4,20 €	1/10/50/800/400	10	235	2,5
O 1628 TENEDOR SERVIR serving fork, fourchette à servir, forchetta servire, serviergabel	4,07 €	1/10/50/800/400	10	235	2,5
P 1629 PALA REPOSTERÍA cake server, pelle à tarte, pala torta, tortenheber	4,07 €	1/10/50/600/2400	10	240	2,7
Q 1632 CAZO SALSA sauce ladle, cuillère à sauce, mestolino salsa, soßenkelle	6,57 €	1/10/50/800/4000	10	170	2,7



	€	UE	MOQ	▶ mm	✂ mm
1297 MAZO 2 CUCHILLO CHULETERO film 2 steak knife, film 2 couteau steak, film 2 coltello bistecca, film 2 steakmesser	5,27 €	1/0/48/1008/3024	48	230	
1298 MAZO 3 CUCHARA MESA film 3 table spoon, film 3 cuillère table, film 3 cucchiaio tavola, film 3 tafellöffel	5,27 €	1/0/48/1200/3600	48	205	3
1299 MAZO 3 TENEDOR MESA film 3 table fork, film 3 fourchette table, film 3 forchetta tavola, film 3 tafelgabel	5,27 €	1/0/48/1200/3600	48	205	3
1315 MAZO 2 CUCHILLO POSTRE film 2 dessert knife, film 2 couteau dessert, film 2 coltello frutta, film 2 dessertmesser	5,27 €	1/0/48/1008/3024	48	200	
1316 MAZO 3 CUCHARA POSTRE film 3 dessert spoon, film 3 cuillère à dessert, film 3 cucchiaio frutta, film 3 dessertlöffel	5,27 €	1/0/48/1200/3600	48	185	2,5
1317 MAZO 3 TENEDOR POSTRE film 3 dessert fork, film 3 fourchette à dessert, film 3 forchetta frutta, film 3 dessertgabel	5,27 €	1/0/48/1200/3600	48	185	2,5
1300 MAZO 6 TENEDOR LUNCH film 6 cake fork, film 6 fourchette gâteau, film 6 forchetta dolce, film 6 kuchengabel	5,27 €	1/0/48/1152/4608	48	145	2
1301 MAZO 6 CUCHARA CAFÉ film 6 tea spoon, film 6 cuillère café, film 6 cucchiaio caffè, film 6 koffeellöffel	5,27 €	1/0/48/1152/4608	48	135	2
1302 MAZO 6 CUCHARA MOKA film 6 coffee/moka spoon, film 6 cuillère moka, film 6 cucchiaio moka, film 6 mokkalöffel	5,27 €	1/0/48/1152/4608	48	115	2



Sevilla S

INOX Nickel Free 18% / 1,8mm / Mirror

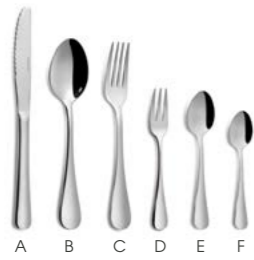

	€	UE	MOQ	✂ mm	✂ mm
A 4712 CUCHILLO MESA MICRODENTADO table knife micro, couteau table micro, coltello tavola micro, tafelmesser micro	1,63 €	0/12/120/1920/5760	120	224	
B 0451 CUCHARA MESA table spoon, cuillère table, cucchiaio tavola, tafellöffel	0,94 €	0/12/120/1440/7200	120	193	1,5
C 0452 TENEDOR MESA table fork, fourchette table, forchetta tavola, tafelgabel	0,94 €	0/12/120/1440/7200	120	190	1,8
D 0453 TENEDOR LUNCH cake fork, fourchette gâteau, forchetta dolce, kuchengabel	0,63 €	0/12/120/2520/15120	120	143	1,5
E 0454 CUCHARA CAFÉ tea spoon, cuillère café, cucchiaio caffè, kaffeelöffel	0,63 €	0/12/120/2520/15120	120	140	1,5
F 0455 CUCHARA MOKA coffee/moka spoon, cuillère moka, cucchiaio moka, mokkalöffel	0,59 €	0/12/120/2520/15120	120	120	1,2
M3950 MAZO 2 CUCHILLO MESA MICRO film 2 table knife micro, film 2 couteau table micro, film 2 coltello tavola micro, film 2 tafelmesser micro	3,55 €	1/0/48/1008/3024	48	224	
M4306 MAZO 3 CUCHARA MESA film 3 table spoon, film 3 cuillère table, film 3 cucchiaio tavola, film 3 tafellöffel	3,55 €	1/0/48/1200/3600	48	193	1,5
M4307 MAZO 3 TENEDOR MESA film 3 table fork, film 3 fourchette table, film 3 forchetta tavola, film 3 tafelgabel	3,55 €	1/0/48/1200/3600	48	190	1,8
M4755 MAZO 6 TENEDOR LUNCH film 6 cake fork, film 6 fourchette gâteau, film 6 forchetta dolce, film 6 kuchengabel	3,55 €	1/0/48/1152/4608	48	143	1,5
M4756 MAZO 6 CUCHARA CAFÉ film 6 tea spoon, film 6 cuillère café, film 6 cucchiaio caffè, film 6 kaffeelöffel	3,55 €	1/0/48/1152/4608	48	140	1,5
M4757 MAZO 6 CUCHARA MOKA film 6 coffee/moka spoon, film 6 cuillère moka, film 6 cucchiaio moka, film 6 mokkalöffel	3,55 €	1/0/48/1152/4608	48	120	1,2
3950 CORBATA 2 CUCHILLO MESA ECO MICRO Tie 2 table knife eco micro, cavalier 2 couteau table eco micro, cravatta 2 coltello tavola eco micro, krawatte 2 tafelmesser eco micro	3,66 €	1/4/48/672/2688	48	224	
4306 CORBATA 3 CUCHARA MESA Tie 3 table spoon, cavalier 3 cuillère table, cravatta 3 cucchiaio tavola, krawatte 3 tafellöffel	3,66 €	1/4/48/672/2688	48	193	1,5
4307 CORBATA 3 TENEDOR MESA Tie 3 table fork, cavalier 3 fourchette table, cravatta 3 forchetta tavola, krawatte 3 tafelgabel	3,66 €	1/4/48/672/2688	48	190	1,8
4755 CORBATA 6 TENEDOR LUNCH Tie 6 cake fork, cavalier 6 fourchette gâteau, cravatta 6 forchetta dolce, krawatte 6 kuchengabel	3,66 €	1/4/48/672/2688	48	143	1,5
4756 CORBATA 6 CUCHARA CAFÉ Tie 6 tea spoon, cavalier 6 cuillère café, cravatta 6 cucchiaio caffè, krawatte 6 kaffeelöffel	3,66 €	1/4/48/672/2688	48	140	1,5
4757 CORBATA 6 CUCHARA MOKA Tie 6 moka spoon, cavalier 6 cuillère moka, cravatta 6 cucchiaio moka, krawatte 6 mokkalöffel	3,66 €	1/4/48/672/2688	48	120	1,2
8239 16 PIEZAS 6 pieces, écriin 16 pièces, bauletto 16 pz., 16 stück	18,84 €	1/0/4/56/112	4		1,8
4885 24 PIEZAS 24 pieces, écriin 24 pièces, bauletto 24 pz., 24 stück	27,31 €	1/0/4/56/112	4		1,8
4999 24 PIEZAS CON CHULETERO 24 pieces + steak knife, écriin 24 pièces + c. steak, bauletto 24 pz. + bistecca, 24 stück + steakmesser	30,90 €	1/0/4/56/112	4		1,8
8672 30 PIEZAS 30 pieces, écriin 30 pièces, bauletto 30 pz., 30 stück	31,09 €	1/0/4/56/112	4		1,8



Sevilla Vintage

INOX Nickel Free 18% / 2,5mm / Vintage

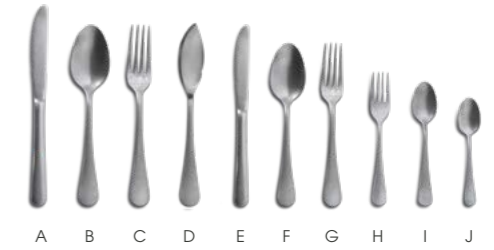

	€	UE	MOQ	✂ mm	✂ mm
A 7425 CUCHILLO MESA table knife, couteau table, coltello tavola, tafelmesser	2,37 €	0/12/120/1920/5760	120	225	
B 7426 CUCHARA MESA table spoon, cuillère table, cucchiaio tavola, tafellöffel	1,44 €	0/12/120/1440/7200	120	198	2,5
C 7427 TENEDOR MESA table fork, fourchette table, forchetta tavola, tafelgabel	1,44 €	0/12/120/1440/7200	120	198	2,5
D 8567 PALA PESCADO fish knife, couteau poisson, coltello pesce, fischmesser	1,18 €	0/12/120/1440/7200	120	200	2,5
E 8568 CUCHILLO POSTRE dessert knife, couteau dessert, coltello frutta, dessertmesser	1,93 €	0/12/120/1440/7200	120	195	
F 8569 CUCHARA POSTRE dessert spoon, cuillère à dessert, cucchiaio frutta, dessertlöffel	1,18 €	0/12/120/1440/7200	120	185	2,5
G 8570 TENEDOR POSTRE dessert fork, fourchette à dessert, forchetta frutta, dessertgabel	1,18 €	0/12/120/1440/7200	120	185	2,5
H 7428 TENEDOR LUNCH cake fork, fourchette gâteau, forchetta dolce, kuchengabel	0,88 €	0/12/120/2520/15120	120	145	2
I 7429 CUCHARA CAFÉ tea spoon, cuillère café, cucchiaio caffè, kaffeelöffel	0,88 €	0/12/120/2520/15120	120	135	2
J 7430 CUCHARA MOKA coffee/moka spoon, cuillère moka, cucchiaio moka, mokkalöffel	0,84 €	0/12/120/2520/15120	120	115	2
8240 16 PIEZAS 16 pieces, écriin 16 pièces, bauletto 16 pz., 16 stück	25,31 €	1/0/4/56/112	4		
7917 24 PIEZAS 24 pieces, écriin 24 pièces, bauletto 24 pz., 24 stück	36,36 €	1/0/4/56/112	4		
8673 30 PIEZAS 30 pieces, écriin 30 pièces, bauletto 30 pz., 30 stück	41,04 €	1/0/4/56/112	4		





		€	UE	MOQ	▶ mm	✕ mm
A	1283 CUCHILLO CHULETERO steak knife, couteau steak, coltello bistecca, steakmesser	2,36 €	0/12/120/1920/5760	60	223	
B	3522 CUCHILLO MESA table knife, couteau table, coltello tavola, tafelmesser	2,37 €	0/12/120/1920/5760	60	225	
C	2700 CUCHARA MESA table spoon, cuillère table, cucchiaio tavola, tafellöffel	1,57 €	0/12/120/1440/7200	120	205	2,5
D	2701 TENEDOR MESA table fork, fourchette table, forchetta tavola, tafelgabel	1,57 €	0/12/120/1440/7200	120	205	2,5
E	2702 PALA PESCADO fish knife, couteau poisson, coltello pesce, fischmesser	1,49 €	0/12/120/1440/7200	120	200	2,5
F	2703 TENEDOR PESCADO fish fork, fourchette poisson, forchetta pesce, fischgabel	1,49 €	0/12/120/1440/7200	120	200	2,5
G	3523 CUCHILLO POSTRE dessert knife, couteau dessert, coltello frutta, dessertmesser	2,17 €	0/12/120/1920/5760	120	196	
H	2705 CUCHARA POSTRE dessert spoon, cuillère à dessert, cucchiaio frutta, dessertlöffel	1,49 €	0/12/120/1440/7200	120	185	2,5
I	2706 TENEDOR POSTRE dessert fork, fourchette à dessert, forchetta frutta, dessertgabel	1,49 €	0/12/120/1440/7200	120	185	2,5
J	2707 TENEDOR LUNCH cake fork, fourchette gâteau, forchetta dolce, kuchengabel	0,88 €	0/12/120/2520/15120	120	145	2
K	2708 CUCHARA CAFÉ tea spoon, cuillère café, cucchiaio caffè, koffeellöffel	0,88 €	0/12/120/2520/15120	120	135	2
L	2709 CUCHARA MOKA coffee/moka spoon, cuillère moka, cucchiaio moka, mokkalöffel	0,87 €	0/12/120/2520/15120	120	115	2
M	2303 CAZO SOPA soup ladle, louche à potage, mestolo, suppenkelle	5,51 €	1/10/50/150/750	10	260	2,5
N	2304 CUCHARA SERVIR serving spoon, cuillère à servir, cucchiaio servir, servierlöffel	4,07 €	1/10/50/?800?4000	10	230	2,8
O	2305 TENEDOR SERVIR serving fork, fourchette à servir, forchetta servire, serviergabel	4,07 €	1/10/50/?800?4000	10	230	2,5
P	2306 PALA REPOSTERÍA cake server, pelle à tarte, pala torta, tortenheber	4,49 €	1/10/50/600/2400	10	240	2,7
Q	2307 CAZO SALSA sauce ladle, cuillère à sauce, mestolino salsa, soßenkelle	5,39 €	1/10/50/800/4000	10	170	2,7



		€	UE	MOQ	▶ mm	✕ mm
M1462	MAZO 2 CUCHILLO CHULETERO film 2 steak knife, film 2 couteau steak, film 2 coltello bistecca, film 2 steakmesser	5,02 €	1/0/48/1008/3024	48	223	
1597	MAZO 3 CUCHARA MESA film 3 table spoon, film 3 cuillère table, film 3 cucchiaio tavola, film 3 tafellöffel	5,02 €	1/0/48/1200/3600	48	205	2,5
1598	MAZO 3 TENEDOR MESA film 3 table fork, film 3 fourchette table, film 3 forchetta tavola, film 3 tafelgabel	5,02 €	1/0/48/1200/3600	48	205	2,5
M4564	MAZO 2 CUCHILLO POSTRE film 2 dessert knife, film 2 couteau dessert, film 2 coltello frutta, film 2 dessertmesser	5,02 €	1/0/48/1008/3024	48	196	
1601	MAZO 3 CUCHARA POSTRE film 3 dessert spoon, film 3 cuillère à dessert, film 3 cucchiaio frutta, film 3 dessertlöffel	5,02 €	1/0/48/1200/3600	48	185	2,5
1602	MAZO 3 TENEDOR POSTRE film 3 dessert fork, film 3 fourchette à dessert, film 3 forchetta frutta, film 3 dessertgabel	5,02 €	1/0/48/1200/3600	48	185	2,5
1603	MAZO 6 TENEDOR LUNCH film 6 cake fork, film 6 fourchette gâteau, film 6 forchetta dolce, film 6 kuchengabel	5,02 €	1/0/48/1152/4608	48	145	2
1604	MAZO 6 CUCHARA CAFÉ film 6 tea spoon, film 6 cuillère café, film 6 cucchiaio caffè, film 6 koffeellöffel	5,02 €	1/0/48/1152/4608	48	135	2
1605	MAZO 6 CUCHARA MOKA film 6 coffee/moka spoon, film 6 cuillère moka, film 6 cucchiaio moka, film 6 mokkalöffel	5,02 €	1/0/48/1152/4608	48	115	2



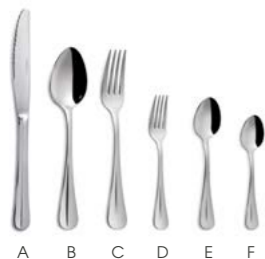

	€	UE	MOQ	▶ mm	✂ mm
A 4632 CUCHILLO MESA table knife, couteau table, coltello tavola, tafelmesser	1,63 €	0/12/120/1920/5760	120	224	
B 0424 CUCHARA MESA table spoon, cuillère table, cucchiaino tavola, tafellöffel	0,94 €	0/12/120/1440/7200	120	193	1,5
C 0425 TENEDOR MESA table fork, fourchette table, forchetta tavola, tafelgabel	0,94 €	0/12/120/1440/7200	120	190	1,8
D 0426 TENEDOR LUNCH cake fork, fourchette gâteau, forchetta dolce, kuchengabel	0,63 €	0/12/120/2520/15120	120	143	1,5
E 0427 CUCHARA CAFÉ tea spoon, cuillère café, cucchiaino caffè, kaffeelöffel	0,63 €	0/12/120/2520/15120	120	140	1,5
F 0428 CUCHARA MOKA coffee/moka spoon, cuillère moka, cucchiaino moka, mokkalöffel	0,59 €	0/12/120/2520/15120	120	120	1,2
8083 MAZO 2 CUCHILLO MESA film 2 knife, film 2 couteau, film 2 coltello, film 2 messer	3,55 €	1/0/48/1008/3024	48	224	
8084 MAZO 3 CUCHARA MESA film 3 table spoon, film 3 cuillère table, film 3 cucchiaino tavola, film 3 tafellöffel	3,55 €	1/0/48/1200/3600	48	193	1,5
8085 MAZO 3 TENEDOR MESA film 3 table fork, film 3 fourchette table, film 3 forchetta tavola, film 3 tafelgabel	3,55 €	1/0/48/1200/3600	48	190	1,8
8086 MAZO 6 TENEDOR LUNCH film 6 cake fork, film 6 fourchette gâteau, film 6 forchetta dolce, film 6 kuchengabel	3,55 €	1/0/48/1152/4608	48	143	1,5
8087 MAZO 6 CUCHARA CAFÉ film 6 tea spoon, film 6 cuillère café, film 6 cucchiaino caffè, film 6 kaffeelöffel	3,55 €	1/0/48/1152/4608	48	140	1,5
8088 MAZO 6 CUCHARA MOKA film 6 coffee/moka spoon, film 6 cuillère moka, film 6 cucchiaino moka, film 6 mokkalöffel	3,55 €	1/0/48/1152/4608	48	120	1,2
5107 CORBATA 2 CUCHILLO MESA Tie 2 table knife, cavalier 2 couteau table, cravatta 2 coltello tavola, krawatte 2 tafelmesser	3,66 €	1/4/48/672/2688	48	224	
4623 CORBATA 3 CUCHARA MESA Tie 3 table spoon, cavalier 3 cuillère table, cravatta 3 cucchiaino tavola, krawatte 3 tafellöffel	3,66 €	1/4/48/672/2688	48	193	1,5
4624 CORBATA 3 TENEDOR MESA Tie 3 table fork, cavalier 3 fourchette table, cravatta 3 forchetta tavola, krawatte 3 tafelgabel	3,66 €	1/4/48/672/2688	48	190	1,8
3515 CORBATA 6 TENEDOR LUNCH Tie 6 cake fork, cavalier 6 fourchette gâteau, cravatta 6 forchetta dolce, krawatte 6 kuchengabel	3,66 €	1/4/48/672/2688	48	143	1,5
3516 CORBATA 6 CUCHARA CAFÉ Tie 6 tea spoon, cavalier 6 cuillère café, cravatta 6 cucchiaino caffè, krawatte 6 kaffeelöffel	3,66 €	1/4/48/672/2688	48	140	1,5
3517 CORBATA 6 CUCHARA MOKA Tie 6 moka spoon, cavalier 6 cuillère moka, cravatta 6 cucchiaino moka, krawatte 6 mokkalöffel	3,66 €	1/4/48/672/2688	48	120	1,2
8241 16 PIEZAS 6 pièces, écriin 16 pièces, bauletto 16 pz., 16 stück	18,84 €	1/0/4/56/112	4	1,8	
4884 24 PIEZAS 24 pièces, écriin 24 pièces, bauletto 24 pz., 24 stück	27,31 €	1/0/4/56/112	4	1,8	
8674 30 PIEZAS 30 pièces, écriin 30 pièces, bauletto 30 pz., 30 stück	31,09 €	1/0/4/56/112	4	1,8	



Mantenimiento de los cubiertos Cutlery care



Prelavado Prewash

- Después de su uso, eliminar los restos de comida que podamos con la ayuda de un estropajo suave.
After use, remove any food residues with a soft scouring pad.
- Sumergirlos en agua.
Submerge them in water.



Lavado automático Automatic washing

- No utilizar productos de limpieza con base ácida ni agua con exceso de cloro.
Don't use acid-based cleaning products or excessively chlorinated water.
- No utilizar detergentes excesivamente abrasivos.
Don't use excessively abrasive detergents.
- Al introducir los cubiertos en el cesto del lavavajillas, recomendamos ponerlos verticalmente con las hojas hacia arriba.
When placing cutlery in the dishwasher basket, we recommend placing them vertically with the blades facing upwards.
- Utilizar un detergente de calidad.
Use a quality detergent.



Lavado a mano Hand wash

- No utilizar estropajos metálicos o sintéticos para evitar el rayado de la cubertería.
Don't use metallic or synthetic scouring pads to avoid scratching the cutlery.
- No utilizar detergentes excesivamente abrasivos.
Don't use excessively abrasive detergents.
- No utilizar productos de limpieza con base ácida ni agua con exceso de cloro.
Don't use acid-based cleaning products or excessively chlorinated water.



Secado Drying

- Nada más terminado el lavado, secar los cubiertos para evitar manchas de gotas de agua y conseguir un brillo duradero.
As soon as you have finished washing, dry the cutlery to avoid water spots and to achieve a long-lasting shine.
- Secar con un paño suave.
Dry with a soft cloth.



		€	UE	MOQ	▶ mm	✂ mm
A	2396 CUCHILLO CHULETERO steak knife, couteau steak, coltello bistecca, steakmesser	2,36 €	0/12/120/1920/5760	60	223	
B	2338 CUCHILLO MESA table knife, couteau table, coltello tavola, tafelmesser	2,36 €	0/12/120/1920/5760	60	222	
C	2632 CUCHARA MESA table spoon, cuillère table, cucchiaino tavola, tafellöffel	1,57 €	0/12/120/1440/7200	120	205	2,5
D	2633 TENEDOR MESA table fork, fourchette table, forchetta tavola, tafelgabel	1,57 €	0/12/120/1440/7200	120	205	2,5
E	2634 PALA PESCADO fish knife, couteau poisson, coltello pesce, fischmesser	1,48 €	0/12/120/1440/7200	120	200	2,5
F	2635 TENEDOR PESCADO fish fork, fourchette poisson, forchetta pesce, fischgabel	1,48 €	0/12/120/1440/7200	120	195	2,5
G	2511 CUCHILLO POSTRE dessert knife, couteau dessert, coltello frutta, dessertmesser	1,99 €	0/12/120/1920/5760	60	196	
H	2637 CUCHARA POSTRE dessert spoon, cuillère à dessert, cucchiaino frutta, dessertlöffel	1,48 €	0/12/120/1440/7200	120	185	2,5
I	2638 TENEDOR POSTRE dessert fork, fourchette à dessert, forchetta frutta, dessertgabel	1,48 €	0/12/120/1440/7200	120	185	2,5
J	2639 TENEDOR LUNCH cake fork, fourchette gâteau, forchetta dolce, kuchengabel	0,91 €	0/12/120/2520/15120	120	145	2
K	2640 CUCHARA CAFÉ tea spoon, cuillère café, cucchiaino caffè, koffeelöffel	0,91 €	0/12/120/2520/15120	120	137	2
L	2641 CUCHARA MOKA coffee/moka spoon, cuillère moka, cucchiaino moka, mokkalöffel	0,88 €	0/12/120/2520/15120	120	115	2
M	2298 CAZO SOPA soup ladle, louche à potage, mestolo, suppenkelle	5,49 €	1/10/50/150/750	10	260	2,5
N	2040 CUCHARA SERVIR serving spoon, cuillère à servir, cucchiaino servir, servierlöffel	4,03 €	1/10/50/800/4000	10	240	2,5
O	2300 TENEDOR SERVIR serving fork, fourchette à servir, forchetta servire, serviergabel	4,03 €	1/10/50/800/4000	10	230	2,5
P	2301 PALA REPOSTERÍA cake server, pelle à tarte, pala torta, tortenheber	4,48 €	1/10/50/600/2400	10	240	2,5
Q	2302 CAZO SALSA sauce ladle, cuillère à sauce, mestolino salsa, saßenkelle	6,18 €	1/10/50/800/4000	10	170	2,7



		€	UE	MOQ	▶ mm	✂ mm
M2397	MAZO 2 CUCHILLO CHULETERO film 2 steak knife, film 2 couteau steak, film 2 coltello bistecca, film 2 steakmesser	4,97 €	1/0/48/1008/3024	48	223	
1635	MAZO 3 CUCHARA MESA film 3 table spoon, film 3 cuillère table, film 3 cucchiaino tavola, film 3 tafellöffel	4,97 €	1/0/48/1200/3600	48	205	2,5
1642	MAZO 3 TENEDOR MESA film 3 table fork, film 3 fourchette table, film 3 forchetta tavola, film 3 tafelgabel	4,97 €	1/0/48/1200/3600	48	205	2,5
M4591	MAZO 2 CUCHILLO POSTRE film 2 dessert knife, film 2 couteau dessert, film 2 coltello frutta, film 2 dessertmesser	4,96 €	1/0/48/1008/3024	48	200	
1644	MAZO 3 CUCHARA POSTRE film 3 dessert spoon, film 3 cuillère à dessert, film 3 cucchiaino frutta, film 3 dessertlöffel	4,97 €	1/0/48/1200/3600	48	185	2,5
1646	MAZO 3 TENEDOR POSTRE film 3 dessert fork, film 3 fourchette à dessert, film 3 forchetta frutta, film 3 dessertgabel	4,97 €	1/0/48/1200/3600	48	185	2,5
1647	MAZO 6 TENEDOR LUNCH film 6 cake fork, film 6 fourchette gâteau, film 6 forchetta dolce, film 6 kuchengabel	4,97 €	1/0/48/1152/4608	48	145	2
1648	MAZO 6 CUCHARA CAFÉ film 6 tea spoon, film 6 cuillère café, film 6 cucchiaino caffè, film 6 koffeelöffel	4,97 €	1/0/48/1152/4608	48	137	2
1649	MAZO 6 CUCHARA MOKA film 6 coffee/moka spoon, film 6 cuillère moka, film 6 cucchiaino moka, film 6 mokkalöffel	4,97 €	1/0/48/1152/4608	48	115	2





A B C D E F



	€	UE	MOQ	▶ mm	✕ mm
A 1623 CUCHILLO MESA table knife, couteau table, coltello tavola, tafelmesser	1,63 €	0/12/120/1920/5760	120	224	
B 3130 CUCHARA MESA table spoon, cuillère table, cucchiaio tavola, tafellöffel	0,94 €	0/12/120/1440/7200	120	193	1,5
C 3131 TENEDOR MESA table fork, fourchette table, forchetta tavola, tafelgabel	0,94 €	0/12/120/1440/7200	120	190	1,8
D 3814 TENEDOR LUNCH cake fork, fourchette gâteau, forchetta dolce, kuchengabel	0,63 €	0/12/120/2520/15120	120	143	1,5
E 3812 CUCHARA CAFÉ tea spoon, cuillère café, cucchiaio caffè, kaffeelöffel	0,63 €	0/12/120/2520/15120	120	140	1,5
F 3813 CUCHARA MOKA coffee/moka spoon, cuillère moka, cucchiaio moka, mokkalöffel	0,59 €	0/12/120/2520/15120	120	120	1,2
M0010 MAZO 2 CUCHILLO MESA film 2 knife, film 2 couteau, film 2 coltello, film 2 messer	3,55 €	1/0/48/1008/3024	48	224	
M3435 MAZO 3 CUCHARA MESA film 3 table spoon, film 3 cuillère table, film 3 cucchiaio tavola, film 3 tafellöffel	3,55 €	1/0/48/1200/3600	48	193	1,5
M3970 MAZO 3 TENEDOR MESA film 3 table fork, film 3 fourchette table, film 3 forchetta tavola, film 3 tafelgabel	3,55 €	1/0/48/1200/3600	48	190	1,8
M4540 MAZO 6 TENEDOR LUNCH film 6 cake fork, film 6 fourchette gâteau, film 6 forchetta dolce, film 6 kuchengabel	3,55 €	1/0/48/1152/4608	48	143	1,5
M4541 MAZO 6 CUCHARA CAFÉ film 6 tea spoon, film 6 cuillère café, film 6 cucchiaio caffè, film 6 kaffeelöffel	3,55 €	1/0/48/1152/4608	48	140	1,5
M4542 MAZO 6 CUCHARA MOKA film 6 coffee/moka spoon, film 6 cuillère moka, film 6 cucchiaio moka, film 6 mokkalöffel	3,55 €	1/0/48/1152/4608	48	120	1,2
0010 CORBATA 2 CUCHILLO MESA Tie 2 table knife, cavalier 2 couteau table, cravatta 2 coltello tavola, krawatte 2 tafelmesser	3,66 €	1/4/48/672/2688	48	224	
3435 CORBATA 3 CUCHARA MESA Tie 3 table spoon, cavalier 3 cuillère table, cravatta 3 cucchiaio tavola, krawatte 3 tafellöffel	3,66 €	1/4/48/672/2688	48	193	1,5
3970 CORBATA 3 TENEDOR MESA Tie 3 table fork, cavalier 3 fourchette table, cravatta 3 forchetta tavola, krawatte 3 tafelgabel	3,66 €	1/4/48/672/2688	48	190	1,8
4540 CORBATA 6 TENEDOR LUNCH Tie 6 cake fork, cavalier 6 fourchette gâteau, cravatta 6 forchetta dolce, krawatte 6 kuchengabel	3,66 €	1/4/48/672/2688	48	143	1,5
4541 CORBATA 6 CUCHARA CAFÉ Tie 6 tea spoon, cavalier 6 cuillère café, cravatta 6 cucchiaio caffè, krawatte 6 kaffeelöffel	3,66 €	1/4/48/672/2688	48	140	1,5
4542 CORBATA 6 CUCHARA MOKA Tie 6 moka spoon, cavalier 6 cuillère moka, cravatta 6 cucchiaio moka, krawatte 6 mokkalöffel	3,66 €	1/4/48/672/2688	48	120	1,2
8244 16 PIEZAS 6 pieces, écriin 16 pièces, bauletto 16 pz., 16 stück	18,84 €	1/0/4/56/112	4		1,8
2455 24 PIEZAS 24 pieces, écriin 24 pièces, bauletto 24 pz., 24 stück	27,31 €	1/0/4/56/112	4		1,8
8676 30 PIEZAS 30 pieces, écriin 30 pièces, bauletto 30 pz., 30 stück	31,09 €	1/0/4/56/112	4		1,8



A B C D E F



	€	UE	MOQ	▶ mm	✕ mm
A 1934 CORBATA 2 CUCHILLO MESA Tie 2 table knife, cavalier 2 couteau table, cravatta 2 coltello tavola, krawatte 2 tafelmesser	3,66 €	1/4/48/672/2688	48	224	
B 3976 CORBATA 3 CUCHARA MESA Tie 3 table spoon, cavalier 3 cuillère table, cravatta 3 cucchiaio tavola, krawatte 3 tafellöffel	3,66 €	1/4/48/672/2688	48	193	1,5
C 3771 CORBATA 3 TENEDOR MESA Tie 3 table fork, cavalier 3 fourchette table, cravatta 3 forchetta tavola, krawatte 3 tafelgabel	3,66 €	1/4/48/672/2688	48	190	1,8
D 4539 CORBATA 6 TENEDOR LUNCH Tie 6 cake fork, cavalier 6 fourchette gâteau, cravatta 6 forchetta dolce, krawatte 6 kuchengabel	3,66 €	1/4/48/672/2688	48	143	1,5
E 2555 CORBATA 6 CUCHARA CAFÉ Tie 6 tea spoon, cavalier 6 cuillère café, cravatta 6 cucchiaio caffè, krawatte 6 kaffeelöffel	3,66 €	1/4/48/672/2688	48	140	1,5
F 4556 CORBATA 6 CUCHARA MOKA Tie 6 moka spoon, cavalier 6 cuillère moka, cravatta 6 cucchiaio moka, krawatte 6 mokkalöffel	3,66 €	1/4/48/672/2688	48	120	1,2
2458 24 PIEZAS 24 pieces, écriin 24 pièces, bauletto 24 pz., 24 stück	27,31 €	1/0/4/56/112	4		1,8



Luna

INOX Nickel Free 18% / 1,8mm / Mirror



A B C D E F



	€	UE	MOQ	✦ mm	✧ mm
A 7142 CUCHILLO MESA table knife, couteau table, coltello tavola, tafelmesser	1,68 €	0/12/120/1920/5760	120	224	
B 7143 CUCHARA MESA table spoon, cuillère table, cucchiaio tavola, tafellöffel	0,97 €	0/12/120/1440/7200	120	193	1,5
C 7144 TENEDOR MESA table fork, fourchette table, forchetta tavola, tafelgabel	0,97 €	0/12/120/1440/7200	120	190	1,8
D 7145 TENEDOR LUNCH cake fork, fourchette gâteau, forchetta dolce, kuchengabel	0,63 €	0/12/120/2520/15120	120	143	1,5
E 7146 CUCHARA CAFÉ tea spoon, cuillère café, cucchiaio caffè, kaffeelöffel	0,63 €	0/12/120/2520/15120	120	140	1,5
F 7147 CUCHARA MOKA coffee/moka spoon, cuillère moka, cucchiaio moka, mokkalöffel	0,59 €	0/12/120/2520/15120	120	120	1,2
7148 MAZO 2 CUCHILLO MESA film 2 knife, film 2 couteau, film 2 coltello, film 2 messer	3,55 €	1/0/48/1008/3024	48	224	
7149 MAZO 3 CUCHARA MESA film 3 table spoon, film 3 cuillère table, film 3 cucchiaio tavola, film 3 tafellöffel	3,55 €	1/0/48/1200/3600	48	193	1,5
7150 MAZO 3 TENEDOR MESA film 3 table fork, film 3 fourchette table, film 3 forchetta tavola, film 3 tafelgabel	3,55 €	1/0/48/1200/3600	48	190	1,8
7151 MAZO 6 TENEDOR LUNCH film 6 cake fork, film 6 fourchette gâteau, film 6 forchetta dolce, film 6 kuchengabel	3,55 €	1/0/48/1152/4608	48	143	1,5
7152 MAZO 6 CUCHARA CAFÉ film 6 tea spoon, film 6 cuillère café, film 6 cucchiaio caffè, film 6 kaffeelöffel	3,55 €	1/0/48/1152/4608	48	140	1,5
7153 MAZO 6 CUCHARA MOKA film 6 coffee/moka spoon, film 6 cuillère moka, film 6 cucchiaio moka, film 6 mokkalöffel	3,55 €	1/0/48/1152/4608	48	120	1,2
7155 CORBATA 2 CUCHILLO MESA Tie 2 table knife, cavalier 2 couteau table, cravatta 2 coltello tavola, krawatte 2 tafelmesser	3,66 €	1/4/48/672/2688	48	224	
7156 CORBATA 3 CUCHARA MESA Tie 3 table spoon, cavalier 3 cuillère table, cravatta 3 cucchiaio tavola, krawatte 3 tafellöffel	3,66 €	1/4/48/672/2688	48	193	1,5
7157 CORBATA 3 TENEDOR MESA Tie 3 table fork, cavalier 3 fourchette table, cravatta 3 forchetta tavola, krawatte 3 tafelgabel	3,66 €	1/4/48/672/2688	48	190	1,8
7158 CORBATA 6 TENEDOR LUNCH Tie 6 cake fork, cavalier 6 fourchette gâteau, cravatta 6 forchetta dolce, krawatte 6 kuchengabel	3,66 €	1/4/48/672/2688	48	143	1,5
7159 CORBATA 6 CUCHARA CAFÉ Tie 6 tea spoon, cavalier 6 cuillère café, cravatta 6 cucchiaio caffè, krawatte 6 kaffeelöffel	3,66 €	1/4/48/672/2688	48	140	1,5
7160 CORBATA 6 CUCHARA MOKA Tie 6 moka spoon, cavalier 6 cuillère moka, cravatta 6 cucchiaio moka, krawatte 6 mokkalöffel	3,66 €	1/4/48/672/2688	48	120	1,2
8242 16 PIEZAS 6 pieces, écrin 16 pièces, bauletto 16 pz., 16 Stück	18,84 €	1/0/4/56/112	4	1,8	
7154 24 PIEZAS 24 pieces, écrin 24 pièces, bauletto 24 pz., 24 Stück	27,31 €	1/0/4/56/112	4	1,8	
8675 30 PIEZAS 30 pieces, écrin 30 pièces, bauletto 30 pz., 30 Stück	31,09 €	1/0/4/56/112	4	1,8	

Luna Satin Black



INOX Nickel Free 18% / 1,8mm / Satin



A B C D



	€	UE	MOQ	✦ mm	✧ mm
A 8011 CUCHILLO MESA table knife, couteau table, coltello tavola, tafelmesser	2,83 €	0/12/120/1920/5760	120	224	
B 8012 CUCHARA MESA table spoon, cuillère table, cucchiaio tavola, tafellöffel	2,13 €	0/12/120/1920/5760	120	193	1,5
C 8013 TENEDOR MESA table fork, fourchette table, forchetta tavola, tafelgabel	2,13 €	0/12/120/1920/5760	120	190	1,8
D 8014 CUCHARA CAFÉ tea spoon, cuillère café, cucchiaio caffè, kaffeelöffel	1,64 €	0/12/120/2520/15120	120	140	1,5
8243 16 PIEZAS 6 pieces, écrin 16 pièces, bauletto 16 pz., 16 Stück	35,23 €	1/0/4/56/112	4	1,8	
8015 24 PIEZAS 24 pieces, écrin 24 pièces, bauletto 24 pz., 24 Stück	54,08 €	1/0/4/56/112	4	1,8	
7434 PACK 2 CUCHILLO MESA Pack 2 table knife, 2 couteau table, 2 coltello tavola, 2 tafelmesser	5,85 €	1/24/96/576/2880	24	224	
7435 PACK 2 CUCHARA MESA Pack 2 table spoon, 2 cuillère table, 2 cucchiaio tavola, 2 tafellöffel	4,64 €	1/24/96/576/2880	24	193	1,5
7436 PACK 2 TENEDOR MESA 2 pack table fork, 2 fourchette table, 2 forchetta tavola, 2 tafelgabel	4,64 €	1/24/96/576/2880	24	190	1,8
7437 PACK 3 CUCHARA CAFÉ pack 3 tea spoon, 3 cuillère café, 3 cucchiaio caffè, 3 kaffeelöffel	5,41 €	1/24/96/?/?	24	140	1,5



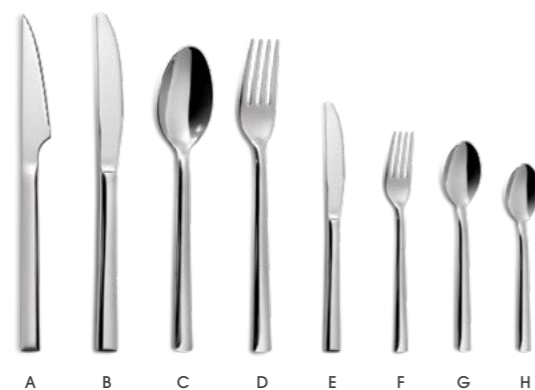

		€	UE	MOQ	▶ mm	✂ mm
A	2454 CUCHILLO CHULETERO steak knife, couteau steak, coltello bistecca, steakmesser	1,72 €	0/12/120/1920/5760	120	225	
B	1613 CUCHILLO MESA ECO table knife, couteau table, coltello tavola, tafelmesser	2,11 €	0/12/120/1920/5760	120	225	
C	2816 CUCHARA MESA table spoon, cuillère table, cucchiaio tavola, tafellöffel	1,19 €	0/12/120/1440/7200	120	203	1,5
D	2817 TENEDOR MESA table fork, fourchette table, forchetta tavola, tafelgabel	1,19 €	0/12/120/1440/7200	120	208	2
E	0021 CUCHILLO LUNCH cake knife, couteau gâteau, coltello dolce, kuchenmesser	1,39 €	0/12/120/1920/5760	120	165	
F	1825 TENEDOR LUNCH cake fork, fourchette gâteau, forchetta dolce, kuchengabel	0,71 €	0/12/120/2520/15120	120	145	1,5
G	1826 CUCHARA CAFÉ tea spoon, cuillère café, cucchiaio caffè, kaffeelöffel	0,71 €	0/12/120/2520/15120	120	140	1,5
H	1827 CUCHARA MOKA coffee/moka spoon, cuillère moka, cucchiaio moka, mokkalöffel	0,69 €	0/12/120/2520/15120	120	125	1,5
M9332	MAZO 2 CUCHILLO CHULETERO film 2 steak knife, film 2 couteau steak, film 2 coltello bistecca, film 2 steakmesser	4,02 €	1/0/48/1008/3024	48	225	
1612	MAZO 2 CUCHILLO MESA ECO film 2 table knife eco, film 2 couteau table eco, film 2 coltello tavola eco, film 2 tafelmesser eco	4,53 €	1/0/48/1008/3024	48	225	
1607	MAZO 3 CUCHARA MESA film 3 table spoon, film 3 cuillère table, film 3 cucchiaio tavola, film 3 tafellöffel	4,02 €	1/0/48/1200/3600	48	205	1,5
1608	MAZO 3 TENEDOR MESA film 3 table fork, film 3 fourchette table, film 3 forchetta tavola, film 3 tafelgabel	4,02 €	1/0/48/1200/3600	48	208	2
1887	MAZO 6 TENEDOR LUNCH film 6 cake fork, film 6 fourchette gâteau, film 6 forchetta dolce, film 6 kuchengabel	4,02 €	1/0/48/1152/4608	48	145	1,5
1610	MAZO 6 CUCHARA CAFÉ film 6 tea spoon, film 6 cuillère café, film 6 cucchiaio caffè, film 6 kaffeelöffel	4,02 €	1/0/48/1152/4608	48	140	1,5
1611	MAZO 6 CUCHARA MOKA film 6 coffee/moka spoon, film 6 cuillère moka, film 6 cucchiaio moka, film 6 mokkalöffel	4,02 €	1/0/48/1152/4608	48	125	1,5
2660	CORBATA 2 CUCHILLO CHULETERO Tie 2 steak knife, cavalier 2 couteau steak, cravatta 2 coltello bistecca, krawatte 2 steakmesser	4,12 €	1/4/48/672/2688	48	225	
2509	CORBATA 3 CUCHARA MESA Tie 3 table spoon, cavalier 3 cuillère table, cravatta 3 cucchiaio tavola, krawatte 3 tafellöffel	4,12 €	1/4/48/672/2688	48	205	1,5
2510	CORBATA 3 TENEDOR MESA Tie 3 table fork, cavalier 3 fourchette table, cravatta 3 forchetta tavola, krawatte 3 tafelgabel	4,12 €	1/4/48/672/2688	48	208	2
1889	CORBATA 6 TENEDOR LUNCH Tie 6 cake fork, cavalier 6 fourchette gâteau, cravatta 6 forchetta dolce, krawatte 6 kuchengabel	4,12 €	1/4/48/672/2688	48	145	1,5
2513	CORBATA 6 CUCHARA CAFÉ Tie 6 tea spoon, cavalier 6 cuillère café, cravatta 6 cucchiaio caffè, krawatte 6 kaffeelöffel	4,12 €	1/4/48/672/2688	48	140	1,5
1890	CORBATA 6 CUCHARA MOKA Tie 6 moka spoon, cavalier 6 cuillère moka, cravatta 6 cucchiaio moka, krawatte 6 mokkalöffel	4,12 €	1/4/48/672/2688	48	125	1,5



8245	16 PIEZAS 6 pieces, écrin 16 pièces, bauletto 16 pz., 16 Stück	21,90 €	1/0/4/56/112	4	1,8
2515	24 PIEZAS 24 pieces, écrin 24 pièces, bauletto 24 pz., 24 Stück	29,47 €	1/0/4/56/112	4	2
8677	30 PIEZAS 30 pieces, écrin 30 pièces, bauletto 30 pz., 30 Stück	35,42 €	1/0/4/56/112	4	1,8





INOX
NICKEL
FREE
18%

B



INOX
NICKEL
FREE
18%



A



C



D

- A **1232** MART VINTAGE / 24 PIEZAS
24 pieces, écrin 24 pièces, bauletto 24 pz., 24 stück
- B **1233** MART VINTAGE GOLD / 24 PIEZAS
24 pieces, écrin 24 pièces, bauletto 24 pz., 24 stück
- C **1234** MART VINTAGE BLACK / 24 PIEZAS
24 pieces, écrin 24 pièces, bauletto 24 pz., 24 stück
- D **1235** MART VINTAGE COPPER / 24 PIEZAS
24 pieces, écrin 24 pièces, bauletto 24 pz., 24 stück

€	UE	MOQ	✂ mm	✂ mm
31,26 €	1/0/4/56/112	6		2,5
43,72 €	1/0/4/56/112	6		2,5
53,70 €	1/0/4/56/112	6		2,5
43,72 €	1/0/4/56/112	6		2,5



- A **0013** CUCHILLO MESA
table knife, couteau table, coltello tavola, tafelmesser
- B **6320** CUCHARA MESA GRANDE EUROPA
europa long table spoon, europa grande cuillère table, cucchiaio tavola europa grande, tafellöffel europa lang
- C **6321** TENEDOR MESA GRANDE EUROPA
europa long table fork, europa grande fourchette table, forchetta tavola europa grande, tafelgabel europa lang
- D **2686** CUCHARA CAFÉ
tea spoon, cuillère café, cucchiaio caffè, kaffeelöffel

€	UE	MOQ	✂ mm	✂ mm
1,68 €	0/12/120/1920/5760	120	214	
1,26 €	0/12/120/1440/7200	120	195	2,5
1,26 €	0/12/120/1440/7200	120	195	2,5
0,68 €	0/12/120/2520/15120	120	140	1,5



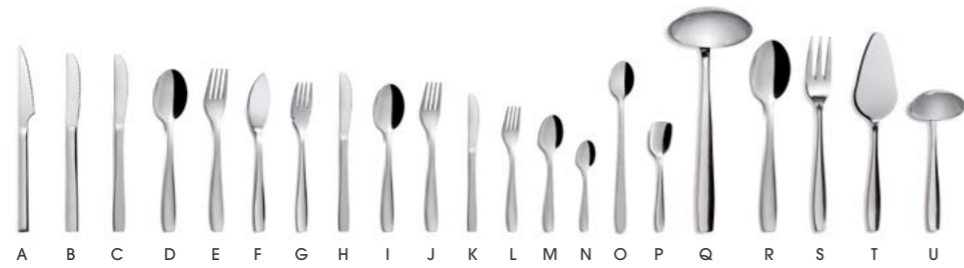

		€	UE	MOQ	✂ mm	✂ mm
A	2454 CUCHILLO CHULETERO steak knife, couteau steak, coltello bistecca, steakmesser	1,72 €	0/12/120/1920/5760	120	225	
B	5497 CUCHILLO MESA MICRODENTADO table knife micro., couteau table micro, coltello tavola micro, tafelmesser micro	1,68 €	0/12/120/1920/5760	120	215	
C	0013 CUCHILLO MESA table knife, couteau table, coltello tavola, tafelmesser	1,68 €	0/12/120/1920/5760	120	214	
D	2679 CUCHARA MESA table spoon, cuillère table, cucchiaio tavola, tafellöffel	0,95 €	0/12/120/1440/7200	120	195	1,5
E	2680 TENEDOR MESA table fork, fourchette table, forchetta tavola, tafelgabel	0,95 €	0/12/120/1440/7200	120	196	2
F	2681 PALA PESCADO fish knife, couteau poisson, coltello pesce, fischmesser	1,01 €	0/12/120/1440/7200	120	190	1,5
G	2682 TENEDOR PESCADO fish fork, fourchette poisson, forchetta pesce, fischgabel	1,01 €	0/12/120/1440/7200	120	180	1,5
H	0018 CUCHILLO POSTRE dessert knife, couteau dessert, coltello frutta, dessertmesser	1,63 €	0/12/120/1920/5760	120	190	
I	2683 CUCHARA POSTRE dessert spoon, cuillère dessert, cucchiaio frutta, dessertlöffel	0,89 €	0/12/120/1440/7200	120	177	1,5
J	2684 TENEDOR POSTRE dessert fork, fourchette dessert, forchetta frutta, dessertgabel	0,89 €	0/12/120/1440/7200	120	180	1,5
K	0021 CUCHILLO LUNCH cake knife, couteau gâteau, coltello dolce, kuchenmesser	1,39 €	0/12/120/1920/5760	120	165	
L	2685 TENEDOR LUNCH cake fork, fourchette gâteau, forchetta dolce, kuchengabel	0,68 €	0/12/120/2520/15120	120	150	1,5
M	2686 CUCHARA CAFÉ tea spoon, cuillère café, cucchiaio caffè, koffeelöffel	0,68 €	0/12/120/2520/15120	120	140	1,5
N	2687 CUCHARA MOKA coffee/moka spoon, cuillère moka, cucchiaio moka, mokkalöffel	0,57 €	0/12/120/2520/15120	120	110	1,2
O	2688 CUCHARA REFRESCO soda spoon, cuillère mazagrán, cucchiaio bibita, longdrinklöffel	0,89 €	0/12/120/1440/7200	120	205	1,5
P	3092 CUCHARA HELADO ice cream spoon, cuillère à glace, cucchiaio gelato, eiscremlöffel	0,83 €	0/12/120/1440/7200	120	132	1,2
Q	2689 CAZO SOPA soup ladle, louche à potage, mestalo, suppenkelle	6,80 €	1/10/50/150/750	10	270	2,6
R	2690 CUCHARA ENSALADA salad spoon, cuillère à servir salade, cucchiaio servire, salatlöffel	5,04 €	1/10/50/800/4000	10	230	2,8
S	2691 TENEDOR ENSALADA salad fork, fourchette à servir salade, forchetta servire, salatgabel	5,04 €	1/10/50/800/4000	10	235	2,6
T	0031 PALA REPOSTERÍA cake server, pelle à tarte, pala torta, tortenheber	5,04 €	1/10/50/600/2400	10	240	2,5
U	5517 CAZO SALSA sauce ladle, cuillère à sauce, mestolino salsa, soßenkelle	6,75 €	1/10/50/800/4000	10	170	2,5



		€	UE	MOQ	✂ mm	✂ mm
M5206	MAZO 2 CUCHILLO MESA film 2 knife, film 2 couteau, film 2 coltello, film 2 messer	3,71 €	1/0/48/1008/3024	48	215	
M5202	MAZO 3 CUCHARA MESA film 3 table spoon, film 3 cuillère table, film 3 cucchiaio tavola, film 3 tafellöffel	3,71 €	1/0/48/1200/3600	48	195	1,5
M5203	MAZO 3 TENEDOR MESA film 3 table fork, film 3 fourchette table, film 3 forchetta tavola, film 3 tafelgabel	3,71 €	1/0/48/1200/3600	48	196	2
M3036	MAZO 6 TENEDOR LUNCH film 6 cake fork, film 6 fourchette gâteau, film 6 forchetta dolce, film 6 kuchengabel	3,71 €	1/0/48/1152/4608	48	150	1,5
M3037	MAZO 6 CUCHARA CAFÉ film 6 tea spoon, film 6 cuillère café, film 6 cucchiaio caffè, film 6 koffeelöffel	3,71 €	1/0/48/1152/4608	48	140	1,5
M3038	MAZO 6 CUCHARA MOKA film 6 coffee/moka spoon, film 6 cuillère moka, film 6 cucchiaio moka, film 6 mokkalöffel	3,71 €	1/0/48/1152/4608	48	110	1,2



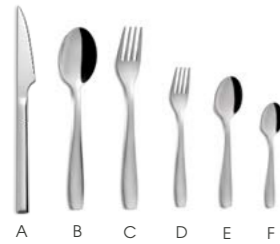

	€	UE	MOQ	✂ mm	✂ mm
A 2454 CUCHILLO CHULETERO steak knife, couteau steak, coltello bistecca, steakmesser	1,72 €	0/12/120/1920/5760	120	225	
B 8009 CUCHARA MESA ECO cake fork eco, fourchette gâteau eco, forchetta dolce eco, kuchengabel eco	0,78 €	0/12/120/1440/7200	120	195	
C 8010 TENEDOR MESA ECO tea spoon eco, cuillère café eco, cucchiaino caffè eco, kaffeelöffel eco	0,78 €	0/12/120/1440/7200	120	196	
D 0940 TENEDOR LUNCH ECO cake fork eco, fourchette gâteau eco, forchetta dolce eco, kuchengabel eco	0,67 €	0/12/120/2520/15120	120	150	1,2
E 0941 CUCHARA CAFÉ ECO tea spoon eco, cuillère café eco, cucchiaino caffè eco, kaffeelöffel eco	0,67 €	0/12/120/2520/15120	120	140	1,2
F 0942 CUCHARA MOKA ECO coffee/moka spoon eco, cuillère moka eco, cucchiaino moka eco, mokkalöffel eco	0,57 €	0/12/120/2520/15120	120	110	1
5206 CORBATA 2 CUCHILLO MESA MICRO Tie 2 steak knife micro, cavalier 2 couteau steak micro, cravatta 2 coltello bistecca micro, krawatte 2 steakmesser micro	3,81 €	1/4/48/672/2688	48	215	
5202 CORBATA 3 CUCHARA MESA Tie 3 table fork, cavalier 3 cuillère table, cravatta 3 cucchiaino tavola, krawatte 3 tafellöffel	3,81 €	1/4/48/672/2688	48	195	1,5
5203 CORBATA 3 TENEDOR MESA Tie 3 table fork, cavalier 3 fourchette table, cravatta 3 forchetta tavola, krawatte 3 tafelgabel	3,81 €	1/4/48/672/2688	48	196	1,5
3036 CORBATA 6 TENEDOR LUNCH Tie 6 cake fork, cavalier 6 fourchette gâteau, cravatta 6 forchetta dolce, krawatte 6 kuchengabel	3,81 €	1/4/48/672/2688	48	150	1,5
3037 CORBATA 6 CUCHARA CAFÉ Tie 6 tea spoon, cavalier 6 cuillère café, cravatta 6 cucchiaino caffè, krawatte 6 kaffeelöffel	3,81 €	1/4/48/672/2688	48	140	1,5
3038 CORBATA 6 CUCHARA MOKA Tie 6 moka spoon, cavalier 6 cuillère moka, cravatta 6 cucchiaino moka, krawatte 6 mokkalöffel	3,81 €	1/4/48/672/2688	48	110	1,2



	€	UE	MOQ	✂ mm	✂ mm
A 2454 CUCHILLO CHULETERO steak knife, couteau steak, coltello bistecca, steakmesser	1,72 €	0/12/120/1920/5760	120	225	
B 5497 CUCHILLO MESA MICRODENTADO table knife micro, couteau table micro, coltello tavola micro, tafelmesser micro	1,68 €	0/12/120/1920/5760	120	215	
C 0013 CUCHILLO MESA table knife, couteau table, coltello tavola, tafelmesser	1,68 €	0/12/120/1920/5760	120	214	
D 0014 CUCHARA MESA table spoon, cuillère table, cucchiaino tavola, tafellöffel	0,61 €	0/12/120/1440/7200	120	195	1,5
E 0015 TENEDOR MESA table fork, fourchette table, forchetta tavola, tafelgabel	0,61 €	0/12/120/1440/7200	120	197	1,5
F 0018 CUCHILLO POSTRE dessert knife, couteau dessert, coltello frutta, dessertmesser	1,63 €	0/12/120/1920/5760	120	190	
G 0019 CUCHARA POSTRE dessert spoon, cuillère dessert, cucchiaino frutta, dessertlöffel	0,57 €	0/12/120/1440/7200	120	177	1,5
H 0020 TENEDOR POSTRE dessert fork, fourchette dessert, forchetta frutta, dessertgabel	0,57 €	0/12/120/1440/7200	120	178	1,5
I 0021 CUCHILLO LUNCH cake knife, couteau gâteau, coltello dolce, kuchenmesser	1,39 €	0/12/120/1920/5760	120	165	
J 0022 TENEDOR LUNCH cake fork, fourchette gâteau, forchetta dolce, kuchengabel	0,39 €	0/12/120/2520/15120	120	150	1,2
K 0023 CUCHARA CAFÉ tea spoon, cuillère café, cucchiaino caffè, kaffeelöffel	0,39 €	0/12/120/2520/15120	120	140	1,2
L 0024 CUCHARA MOKA coffee/moka spoon, cuillère moka, cucchiaino moka, mokkalöffel	0,35 €	0/12/120/2520/15120	120	110	1
M 0033 CUCHARA REFRESCO soda spoon, cuillère mazagan, cucchiaino bibita, longdrinklöffel	0,71 €	0/12/120/1440/72008	120	205	1,5



* Bolsa con apertura lateral.



	€	UE	MOQ	▶ mm	✂ mm
A 8334 CUCHILLO MESA table knife, couteau table, coltello tavola, tafelmesser	0,22 €	0/12/360/7200/14400	360	185	0,6
B 8335 CUCHARA MESA table spoon, cuillère table, cucchiaio tavola, tafellöffel	0,21 €	0/12/360/7200/14400	360	170	0,6
C 8336 TENEDOR MESA table fork, fourchette table, forchetta tavola, tafelgabel	0,18 €	0/12/360/7200/14400	360	170	0,6
D 8337 CUCHARA CAFÉ tea spoon, cuillère café, cucchiaio caffè, kaffeelöffel	0,15 €	0/12/600/7200/36000	600	120	0,6
8338 KIT 4 PCS CUCHILLO, TENEDOR, CUCHARA Y SERVILLETA set table knife/fork/spoon + napkin set couteau table/cuillère table/fourchette table + serviette set coltello tavola/cucchiaio tavola /forchetta tavola + tovagliolo set tafelmesser/tafellöffel/tafelgabel + serviettel	0,83 €	1/0/120/0/0	120		0,6
8184 KIT 4 PCS CUCHILLO, TENEDOR, CUCHARA CAFÉ Y SERVILLETA set table knife/fork/tea spoon + napkin set couteau table/cuillère café/fourchette table + serviette set coltello tavola/cucchiaio caffè /forchetta tavola + tovagliolo set tafelmesser/kaffeelöffel/tafelgabel + serviette	0,98 €	1/0/50/200/0	50		0,6



* Los cubiertos no van incluidos
Cutlery is not included

	€	UE	MOQ	▶ mm	✂ mm
A 8372 BOLSA BEIGE 25*7 beige bag, sac beige, borsa beige, beige tasche	1,13 €	1/6/120/0/0	6	255	
B 8373 CAJA PP 23,5*3,2 pp box, boîte pp, scatola pp, box pp	1,03 €	1/6/120/0/0	6	210	
C 8374 FUNDA 25*6 CON CIERRE zippered cover, couverture zippée, copertura con cerniera, reibverschlussabdeckung	1,32 €	1/6/120/0/0	6	260	
D 8375 BOLSA JAPONESA 22*22 japanese bag, sac japonais, borsa giapponese, japanische tasche	2,99 €	1/6/120//	6	240	
E 8376 FUNDA JAPONESA 24*6 japanese bag, sac japonais, borsa giapponese, japanische tasche	1,44 €	1/0/4/?/?	6	250	



INOX
NICKEL
FREE
18%

	€	UE	MOQ	✂ mm	✂ mm
A 6505 CUCHILLO MESA table knife, couteau table, coltello tavola, tafelmesser	1,47 €	0/12/120/1920/5760	120	210	
B 6506 CUCHARA MESA table spoon, cuillère table, cucchiaio tavola, tafellöffel	0,54 €	0/24/360/7200/14400	360	200	1,2
C 6507 TENEDOR MESA table fork, fourchette table, forchetta tavola, tafelgabel	0,54 €	0/24/360/7200/14400	360	200	1,2
D 6509 TENEDOR LUNCH cake fork, fourchette gâteau, forchetta dolce, kuchengabel	0,31 €	0/60/600/12600/37800	60	150	1,2
E 6510 CUCHARA TÉ iced tea spoon, cuillère à té, cucchiaio the, cocktailöffel	0,36 €	0/60/600/13200/26400	60	150	1,2
F 6342 CUCHARA CAFÉ tea spoon, cuillère café, cucchiaio caffè, kaffeelöffel	0,26 €	0/60/600/16800/50400	60	122	1
G 6343 CUCHARA MOKA coffee/moka spoon, cuillère moka, cucchiaio moka, mokkalöffel	0,18 €	0/60/600/25200/75600	60	103	1
H 6508 CUCHARA REFRESCO soda spoon, cuillère mazagran, cucchiaio bibita, longdrinklöffel	0,42 €	0/24/360/7200/14400	360	202	1,2



INOX
NICKEL
FREE
18%



	€	UE	MOQ	✂ mm	✂ mm
A 6500 CUCHILLO MESA table knife, couteau table, coltello tavola, tafelmesser	1,47 €	0/12/120/1920/5760	120	220	
B 6501 CUCHARA MESA table spoon, cuillère table, cucchiaio tavola, tafellöffel	0,54 €	0/24/360/7200/14400	360	200	1,2
C 6502 TENEDOR MESA table fork, fourchette table, forchetta tavola, tafelgabel	0,54 €	0/24/360/7200/14400	360	200	1,2
D 6504 TENEDOR LUNCH cake fork, fourchette gâteau, forchetta dolce, kuchengabel	0,31 €	0/60/600/12600/37800	60	150	1,2
E 6605 CUCHARA TÉ iced tea spoon, cuillère à té, cucchiaio the, cocktailöffel	0,36 €	0/60/600/13200/26400	60	150	1,2
F 6338 CUCHARA CAFÉ tea spoon, cuillère café, cucchiaio caffè, kaffeelöffel	0,26 €	0/60/600/16800/50400	60	120	1
G 6339 CUCHARA MOKA coffee/moka spoon, cuillère moka, cucchiaio moka, mokkalöffel	0,18 €	0/60/600/25200/75600	60	102	1
H 6503 CUCHARA REFRESCO soda spoon, cuillère mazagran, cucchiaio bibita, longdrinklöffel	0,42 €	0/24/360/7200/14400	360	202	1,2



	€	UE	MOQ	▶ mm	✂ mm
A 1489 CUCHILLO MESA table knife, couteau table, coltello tavola, tafelmesser	1,68 €	0/12/120/1920/5760	120	210	
B 0001 CUCCHARA MESA table spoon, cuillère table, cucchiaio tavola, tafellöffel	0,60 €	0/12/360/7200/14400	360	200	1,5
C 0002 TENEDOR MESA table fork, fourchette table, forchetta tavola, tafelgabel	0,60 €	0/12/360/7200/14400	360	200	1,5
D 0009 CUCHILLO POSTRE dessert knife, couteau dessert, coltello frutta, dessertmesser	1,58 €	0/12/120/1920/5760	120	190	
E 0003 CUCCHARA CADETE dessert spoon, cuillère dessert, cucchiaio frutta, dessertlöffel	0,55 €	0/12/360/8640/17280	360	185	1,2
F 0004 TENEDOR CADETE dessert fork, fourchette dessert, forchetta frutta, dessertgabel	0,55 €	0/12/360/10800/21600	360	185	1,2
G 0005 TENEDOR LUNCH cake fork, fourchette gâteau, forchetta dolce, kuchengabel	0,30 €	0/12/600/16800/50400	600	140	1,2
H 4504 TENEDOR MINI LUNCH mini cake fork, fourchette minigâteau, forchetta mini dolce, kuchengabel klein	0,24 €	0/12/600/25200/75600	600	110	1
I 1664 CUCCHARA CAFÉ REFORZADA tea spoon reinf., cuillère café renforcé, cucchiaio caffè rinforzato, kaffeelöffel verstärkt	0,32 €	0/12/600/12000/36000	600	140	1,2
J 0006 CUCCHARA CAFÉ tea spoon, cuillère café, cucchiaio caffè, kaffeelöffel	0,30 €	0/12/600/12000/36000	600	140	1
K 2731 CUCCHARA CAFÉ ECO tea spoon eco, cuillère café eco, cucchiaio caffè eco, kaffeelöffel eco	0,25 €	0/12/600/12000/36000	600	140	1
L 0007 CUCCHARA MOKA coffee/moka spoon, cuillère moka, cucchiaio moka, makkalöffel	0,24 €	0/12/600/25200/75600	600	110	1
2459 2 CUCCHARA MESA 2 table spoon, 2 cuillère table, 2 cucchiaio tavola, 2 tafellöffel	1,12 €	2/18/270/5400/10800	270	185	1,2
2460 2 TENEDOR MESA 2 table fork, 2 fourchette table, 2 forchetta tavola, 2 tafelgabel	1,12 €	2/18/270/5400/10800	270	185	1,2
2461 4 TENEDOR PASTEL 4 cake fork, 4 fourchette gâteau, 4 forchetta dolce, 4 kuchengabel	1,12 €	2/18/270/5400/10800	270	140	1,2
2462 4 CUCCHARA CAFÉ 4 tea spoon, 4 cuillère café, 4 cucchiaio caffè, 4 kaffeelöffel	1,12 €	2/18/270/5400/10800	270	140	1
2463 4 CUCCHARA MOKA 4 coffee/moka spoon, 4 cuillère moka, 4 cucchiaio moka, 4 makkalöffel	1,12 €	4/18/270/6750/13500	270	110	1

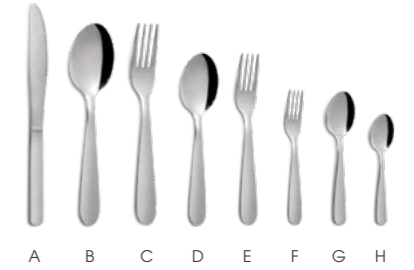

	€	UE	MOQ	▶ mm	✂ mm
A 0481 CUCHILLO MESA table knife, couteau table, coltello tavola, tafelmesser	0,69 €	0/12/240/6000/18000	240	220	2,5
B 3185 CUCCHARA MESA table spoon, cuillère table, cucchiaio tavola, tafellöffel	0,44 €	0/12/360/7200/14400	360	200	1,5
C 3186 TENEDOR MESA table fork, fourchette table, forchetta tavola, tafelgabel	0,44 €	0/12/360/10440/20880	360	200	1,5
D 3187 CUCCHARA POSTRE dessert spoon, cuillère dessert, cucchiaio frutta, dessertlöffel	0,42 €	0/12/360/10800/21600	360	170	1,5
H 3188 TENEDOR POSTRE dessert fork, fourchette dessert, forchetta frutta, dessertgabel	0,42 €	0/12/360/10800/21600	360	170	1,5
F 3189 TENEDOR LUNCH cake fork, fourchette gâteau, forchetta dolce, kuchengabel	0,23 €	0/12/600/16800/50400	600	133	1,2
G 3190 CUCCHARA CAFÉ tea spoon, cuillère café, cucchiaio caffè, kaffeelöffel	0,23 €	0/12/600/12000/36000	600	133	1,2
H 3191 CUCCHARA MOKA coffee/moka spoon, cuillère moka, cucchiaio moka, makkalöffel	0,19 €	0/12/600/25200/75600	600	110	1
4571 2 CUCHILLO MESA ECO 2 table knife eco, 2 couteau table eco, 2 coltello tavola eco, 2 tafelmesser eco	1,24 €	0/18/270/3240/6480	270	220	
3192 3 CUCCHARA MESA 3 table spoon, 3 cuillère table, 3 cucchiaio tavola, 3 tafellöffel	1,24 €	0/12/180/2700/5400	180	170	1,5
3193 3 TENEDOR MESA 3 table fork, 3 fourchette table, 3 forchetta tavola, 3 tafelgabel	1,24 €	0/12/180/3600/7200	180	170	1,5
3194 6 TENEDOR PASTEL 6 cake fork, 6 fourchette gâteau, 6 forchetta dolce, 6 kuchengabel	1,24 €	0/12/180/3600/7200	180	133	1,2
3195 6 CUCCHARA CAFÉ 6 tea spoon, 6 cuillère café, 6 cucchiaio caffè, 6 kaffeelöffel	1,24 €	0/12/180/3600/7200	180	133	1,2
3196 6 CUCCHARA MOKA 6 coffee/moka spoon, 6 cuillère moka, 6 cucchiaio moka, 6 makkalöffel	1,24 €	0/12/180/3600/10800	180	110	1

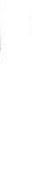



INOX
NICKEL
FREE
18%



INOX
NICKEL
FREE
18%



	€	UE	MOQ	✂ mm	✂ mm
A 3618 CUCHILLO MESA table knife, couteau table, coltello tavola, tafelmesser	1,61 €	0/12/120/1920/5760	120	224	
B 3548 3 CUCHARA MESA 3 table spoon, 3 cuillère table, 3 cucchiaino tavola, 3 tafellöffel	1,24 €	3/12/180/3600/7200	180	185	1,2
C 3549 3 TENEDOR MESA 3 table fork, 3 fourchette table, 3 forchetta tavola, 3 tafelgabel	1,24 €	3/12/180/3600/7200	180	185	1,2
D 3550 6 TENEDOR PASTEL 6 cake fork, 6 fourchette gâteau, 6 forchetta dolce, 6 kuchengabel	1,24 €	6/12/180/3600/7200	180	140	1
E 3551 6 CUCHARA CAFÉ 6 tea spoon, 6 cuillère café, 6 cucciaio caffè, 6 kaffeelöffel	1,24 €	6/12/180/3600/7200	180	140	1
F 3552 6 CUCHARA MOKA 6 coffee/moka spoon, 6 cuillère moka, 6 cucciaio moka, 6 mokkalöffel	1,24 €	6/12/180/4500/9600	180	110	1



	€	UE	MOQ	✂ mm	✂ mm
A 0278 3 CUCHARA MESA 3 table spoon, 3 cuillère table, 3 cucchiaino tavola, 3 tafellöffel	1,24 €	3/12/180/3600/7200	180	185	1,2
B 0279 3 TENEDOR MESA 3 table fork, 3 fourchette table, 3 forchetta tavola, 3 tafelgabel	1,24 €	3/12/180/3600/7200	180	185	1,2
C 0280 6 TENEDOR PASTEL 6 cake fork, 6 fourchette gâteau, 6 forchetta dolce, 6 kuchengabel	1,24 €	6/12/180/3600/7200	180	140	1,2
D 0281 6 CUCHARA CAFÉ 6 tea spoon, 6 cuillère café, 6 cucciaio caffè, 6 kaffeelöffel	1,24 €	6/12/180/3600/7200	180	140	1
E 0282 6 CUCHARA MOKA 6 coffee/moka spoon, 6 cuillère moka, 6 cucciaio moka, 6 mokkalöffel	1,24 €	6/12/180/4500/9000	180	110	1



Chuleteros

Steak Knives



CHULETEROS STEAK KNIVES

- 202 HQ
- 212 INOX
- 214 NAPOLI PIZZA COLLETION
- 216 ECO
- 217 BASIC KNIVES



CUCHILLO CHULETERO K6 - BOJ SATIN GOLD

	€	UE	MOQ	✂ mm	✂ mm
A 0242 CUCHILLO CHULETERO K3 MALVA <small>k2 malva steak knife, couteau steak k3 malva, coltello bistecca k3 malva, steak-messer k3 malva</small>	9,27 €	0/6/60/720/3600	60	235	
B 3008 CUCHILLO CHULETERO K4 KENTIA <small>k4 kentia steak knife, couteau steak k4 kentia, coltello bistecca k4 kentia, steak-messer k4 kentia</small>	5,07 €	0/6/60/720/3600	60	225	
C 3031 CUCHILLO CHULETERO K5 YUCCA <small>k5 yucca steak knife, couteau steak k5 yucca, coltello bistecca k5 yucca, steak-messer k5 yucca</small>	5,19 €	0/6/60/720/3600	60	232	
D 2999 CUCHILLO CHULETERO K6 BOJ SATIN <small>k6 boj satin steak knife, couteau steak k6 boj satin, coltello bistecca k6 boj satin, steak-messer k6 boj satin</small>	4,82 €	0/6/60/720/3600	60	221	
E 6013 CUCHILLO CHULETERO K6.2 BOJ <small>k6.2 boj steak knife, couteau steak k6.2 boj, coltello bistecca k6.2 boj satin, steackmesser k6.2 boj</small>	4,82 €	0/6/60/720/3600	60	221	
F 7432 CUCHILLO CHULETERO K6 BOJ SATIN GOLD <small>boj satin/k6 steak knife gold, couteau steak boj satin/k6 gold, coltello bistecca boj satin/k6 gold, steackmesser boj satin/k6 gold</small>	8,88 €	0/6/60/720/2880	60	221	
G 7433 CUCHILLO CHULETERO K6 BOJ SATIN GUNMETAL <small>boj satin/k6 steak knife gunmetal, couteau steak boj satin/k6 gunmetal, coltello bistecca boj satin/k6 gunmetal, steackmesser boj satin/k6 gunmetal</small>	8,88 €	0/6/60/720/2880	60	221	
H 7431 CUCHILLO CHULETERO K6 BOJ SATIN COPPER <small>boj satin/k6 steak knife copper, couteau steak boj satin/k6 copper, coltello bistecca boj satin/k6 copper, steackmesser boj satin/k6 copper</small>	8,88 €	0/6/60/720/2880	60	221	





CUCHILLO CHULETERO K8 - WILLOW GREEN



	€	UE	MOQ	✂ mm	✂ mm
A 3009 CUCHILLO CHULETERO K7 PERSIL k7 persil steak knife, couteau steak k7 persil, coltello bistecca k7 persil, steakmesser k7 persil	5,07 €	0/6/60/720/3600	60	217	
B 3110 CHULETERO K8-BLACK WILLOW k8-black willow steak knife, couteau steak k8-black willow, coltello bistecca k8-nero willow, steakmesser k8-black willow	2,06 €	0/6/60/720/3600	60	226	
C 3111 CHULETERO K8-BROWN WILLOW k8-brown willow steak knife, couteau steak k8-brown willow, coltello bistecca k8-marrone willow, steakmesser k8-brown willow	2,06 €	0/6/60/720/3600	60	226	
D 3112 CHULETERO K8-GREEN WILLOW k8-green willow steak knife, couteau steak k8-green willow, coltello bistecca k8-green willow, steakmesser k8-green willow	2,06 €	0/6/60/720/3600	60	226	
E 7442 CUCHILLO CHULETERO ACR WHITE acr white steak knife, couteau steak acr white, coltello bistecca acr white, steak messer acr white	8,64 €	0/6/60/720/2880	60	225	86
F 7443 CUCHILLO CHULETERO ACR RED acr red steak knife, couteau steak acr red, coltello bistecca acr red, steak messer acr red	8,64 €	0/6/60/720/2880	60	225	86
G 7444 CUCHILLO CHULETERO MONTBLANC BLACK montblanc black steak knife, couteau steak montblanc black, coltello bistecca montblanc black, steak messer montblanc black	9,68 €	0/6/60/720/2880	60	230	97





CUCHILLO CHULETERO ANETO MIKARTA



		€	UE	MOQ	✂ mm	✂ mm
NEW A	8508 CUCHILLO CHULETERO ANETO MIKARTA aneto mikarta steak knife, couteau steak aneto mikarta, coltello bistecca aneto mikarta, steakmesser aneto mikarta	14,94 €	0/6/60/720/2880	60	223	
B	7532 CUCHILLO CHULETERO ANETO aneto blackteak knife, couteau steak aneto, coltello bistecca aneto, steakmesser aneto	10,36 €	0/6/60/720/2880	60	223	
C	7445 CUCHILLO CHULETON ACONCAGUA BLACK aconcagua black steak knife, couteau steak aconcagua black, coltello bistecca aconcagua black, steak messer aconcagua black	13,91 €	0/6/60/540/2160	60	258	
D	7446 CUCHILLO CHULETON ACONCAGUA aconcagua steak knife, couteau steak aconcagua, coltello bistecca aconcagua, steak messer aconcagua	13,91 €	0/6/60/540/2160	60	258	
E	7447 CUCHILLO QUESO ZERMAT zermatt cheese knife, couteau à fromage zermatt, coltello da formaggio zermatt, kosemesser zermatt	10,33 €	0/6/60/540/2160	60	205	
	6161 CUCHILLO CHULETERO GEOMETRIC geometric steak knife, couteau steak geometric, coltello bistecca geometric, steak-messer geometric	4,85 €	0/6/60/540/2160	60	223	
F	6333 6 PCS MADERA GEOMETRIC geometric 6 pieces wood, écrin 6 pièces géométric, bauletto in legno 6 pz. geometric, geometric 6 Stück holz	37,41 €	1/6/78/234	6	232	
	3107 CUCHILLO CHULETERO SUTIL sutil steak knife, couteau steak sutil, coltello bistecca sutil, sutil steakmesser	3,54 €	0/6/60/720/3600	60	232	
G	5277 6 PCS MADERA SUTIL sutil 6 pieces wood, écrin 6 pièces sutil, bauletto in legno 6 pz. sutil, sutil 6 Stück holz	29,66 €	1/6/78/234	6	232	





CUCHILLO CHULETERO ALPS

		€	UE	MOQ	▶ mm	✂ mm
A	3000 CHULETERO ALPS alps steak knife, couteau steak alps, coltello bistecca alps, steakmesser alps	8,98 €	0/6/60/540/2160	60	230	
	5286 6 PCS MADERA ALPS alps 6 pieces wood, écrin 6 pièces alps, bauletto in legno 6 pz. alps, alps 6 stück holz	63,86 €	1/6/78/234	6	230	
B	3013 CHULETERO ALPS FILO alps filo steak knife, couteau steak alps filo, coltello bistecca alps filo, steakmesser alps filo	8,97 €	0/6/60/540/2160	60	230	
	6887 6 PCS MADERA ALPS FILO alps filo steak knife 6 pieces wood, écrin 6 pièces alps, bauletto in legno 6 pz. alps, alps 6 stück holz	63,09 €	1/6/78/234	6	230	
C	6162 TENEDOR CHULETERO ALPS alps steak fork, fourchette steak alps, forchetta bistecca alps, steakgabel alps	8,98 €	0/6/60/540/2160	60	227	
	6334 6 PCS MADERA TENEDOR ALPS alps fork 6 pieces wood, écrin 6 pièces fourchette alps, bauletto in legno 6 pz. forchetta alps, gabel 6 stück holz alps	63,86 €	1/6/78/234	6	227	
D	3137 CHULETERO K2 NEGRO k2 black steak knife, couteau steak k2 noir, coltello bistecca k2 nero, steakmesser k2 schwarz	10,31 €	0/6/60/540/2160	60	225	
	5278 6 PCS MADERA K2 NEGRO k2 black 6 pieces wood, écrin 6 pièces k2 noir, bauletto in legno 6 pz. k2 nero, k2 schwarz 6 stück holz	66,82 €	1/6/78/34	6	225	
E	3001 CHULETERO NICOLAS nicolas steak knife, couteau steak nicolas, coltello bistecca nicolas, steakmesser nicolas	8,06 €	0/6/60/540/2160	60	230	
	5280 6 PCS MADERA NICOLAS nicolas 6 pieces wood, écrin 6 pièces nicolas, bauletto in legno 6 pz. nicolas, nicolas 6 stück holz	58,71 €	1/6/78/234	6	230	
F	3136 CHULETERO K2 k2 steak knife, couteau steak k2, coltello bistecca k2, steakmesser k2	10,25 €	0/6/60/540/2160	60	225	
	5287 6 PCS MADERA K2 k2 6 pieces wood, écrin 6 pièces k2, bauletto in legno 6 pz. k2, k2 6 stück holz	67,74 €	1/6/78/234	6	225	
G	3010 CHULETERO ACR NEGRO acr black steak knife, couteau steak acr noir, coltello bistecca acr nero, steakmesser acr schwarz	8,64 €	0/6/60/540/2160	60	225	
	5279 6 PCS MADERA ACR NEGRO acr black 6 pieces wood, écrin 6 pièces acr noir, bauletto in legno 6 pz. acr nero, acr schwarz 6 stück holz	59,49 €	1/6/78/234	6	225	
H	3011 TENEDOR CHULETERO ACR NEGRO acr black steak fork, fourchette steak acr noir, forchetta bistecca acr nero, steakgabel acr schwarz	8,64 €	0/6/60/540/2160	60	210	2
	6335 6 PCS MADERA TENEDOR ACR NEGRO acr black fork 6 pieces wood, écrin 6 pièces fourchette acr noir, bauletto in legno 6 pz. forchetta acr nero, 6 stück holz gabel acr schwarz	59,49 €	1/6/78/234	6	210	2



A



B



C



D



E



F



G



H



CUCHILLO CHULETERO MONTBLANC



		€	UE	MOQ	▶ mm	✂ mm
A	2818 CUCHILLO CHULETERO RAMBO steak knife rambo, couteau steak rambo, coltello bistecca rambo, steakmesser rambo	5,77 €	6/60/720/3600	60	225	
	5288 6 PCS MADERA RAMBO rambo 6 pieces wood, écrin 6 pièces rambo, bauletto in legno 6 pz. rambo, rambo 6 stück holz	42,23 €	1/6/78/234	6	225	
B	6164 CUCHILLO CHULETERO TORINO torino steak knife, couteau steak torino, coltello bistecca torino, steakmesser torino	9,58 €	0/6/60/780/3120	60	230	
C	6163 CUCHILLO CHULETERO ZERMATT zermatt steak knife, couteau steak zermatt, coltello bistecca zermatt, steakmesser zermatt	10,07 €	6/60/780/3120	60	227	
D	7067 CUCHILLO CHULETERO KILIMANJARO kilimanjaro steak knife, couteau steak kilimanjaro, coltello bistecca kilimanjaro, steakmesser kilimanjaro	14,16 €	6/60/780/3120	60	245	
	7068 CUCHILLO CHULETERO MONTBLANC montblanc steak knife, couteau steak montblanc, coltello bistecca montblanc, steakmesser montblanc	9,09 €	6/60/720/3600	60	230	
E	5285 6 PCS MADERA MONTBLANC montblanc steak knife 6 pieces wood, écrin bois 6 couteaux montblanc, 6 pz legno montblanc, 6-teilige holz-untersetzer montblanc	66,60 €	1/6/78/234	6	230	
F	8595 CUCHILLO CHULETERO MONTBLANC NEGRO montblanc black steak knife, couteau steak montblanc black, coltello bistecca montblanc black, steak messer montblanc black	10,30 €	6/60/720/3600	60		
G	3100 CUCHILLO CHULETERO CHURRASCO churrasco steak knife, couteau steak churrasco, coltello bistecca churrasco, churrasco steakmesser	6,08 €	6/60/540/2160	60	254	





CUCHILLO CHULETERO MADRID



	€	UE	MOQ	▶ mm	✂ mm
A 2072 CUCHILLO CHULETERO PERFECT perfect steak knife, couteau steak perfect, coltello bistecca perfect, perfekt steakmesser	2,22 €	0/12/120/1920/5760	120	224	
B 5903 TENEDOR CHULETERO PERFECT perfect steak fork, fourchette steak perfect, forchetta bistecca perfect, perfekt steakgabel	1,91 €	0/12/120/1920/7200	120	195	
C 2732 CUCHILLO CHULETERO PERFECT PREMIUM perfect premium steak knife, couteau steak perfect premium, coltello bistecca perfect premium, perfekt premium steakmesser	2,62 €	0/12/120/1920/5760	120	224	
D M1538 2 CUCHILLO CHULETERO PERFECT LACASA 2 perfect steak knife lacasa, 2 couteau steak perfect lacasa, 2 coltello bistecca perfect lacasa, 2 perfekt steakmesser lacasa	4,04 €	2/0/48/1008/2016	48	215	
E 6116 CUCHILLO STANDING standing knife, couteau standing, coltello standing, standing tafelmesser	6,08 €	0/12/120/1920/5760	60	231	
F 1339 CUCHILLO CHULETERO MADRID steak knife, couteau steak madrid, coltello bistecca madrid, steakmesser madrid	2,68 €	0/12/120/1920/5760	120	224	
G 2935 CUCHILLO CHULETERO TORONTO toronto steak knife, couteau steak toronto, coltello bistecca toronto, toronto steakmesser	2,94 €	0/12/120/1920/5760	120	225	
H 5447 CUCHILLO CHULETERO PERFECT ECO perfect eco steak knife, couteau steak perfect eco, coltello bistecca perfect eco, steakmesser perfect eco	1,88 €	0/12/120/1920/5760	120	215	
I 5631 CUCHILLO CHULETERO NORDIC nordic steak knife, couteau steak nordic, coltello bistecca nordic, nordic steakmesser	2,36 €	0/12/120/1920/5760	60	230	
J 4713 CUCHILLO CHULETERO NORDIC ECO nordic steak knife eco, couteau steak nordic eco, coltello bistecca nordic eco, nordic steakmesser eco	1,62 €	0/12/120/1920/5760	120	230	





A



B



C



D



	€	UE	MOQ	▶ mm	✂ mm
A 3263 CUCHILLO PIZZA pizza knife, couteau pizza, coltello pizza, pizza tafelmesser	2,63 €	0/12/120/1920/5760	120	205	
B 3264 TENEDOR PIZZA pizza fork, fourchette pizza, forchetta pizza, pizza gabel	2,01 €	0/12/120/1920/5760	120	202	4
C 3265 BLISTER 3 CUCHILLO PIZZA blister 3 pizza knife, blister 3 couteau pizza, blister 3 coltello pizza, blister pizza-messer	8,76 €	1/0/24/4561/2280	24	205	
D 3266 BLISTER CUCHILLO + TENEDOR PIZZA blister pizza knife + fork, blister couteau + fourchette pizza, blister coltello + forchetta pizza, blister pizza messer + gabel	5,15 €	1/0/48/576/2304	48	205	4



A



B



C



D



E



F



G



H

	€	UE	MOQ	✂ mm	✂ mm
A 3002 CHULETON NEGRO big black steak knife, gros couteau steak noir, grande coltello bistecca nero, gros steakmesser schwarz	3,20 €	0/12/120/2520/5040	120	232	
B 3004 CHULETERO FINO NEGRO black thin steak knife, couteau steak fin noir, coltello bistecca sottile nero, steakmesser schwarz dünn	2,87 €	0/12/120/2880/5760	120	212	
C 3003 TENEDOR CHULETERO NEGRO black steak fork, fourchette steak noire, forchetta bistecca nera, steakgabel schwarz	3,20 €	0/12/120/2520/5040	120	191	
D 0072 CUCHILLO MANTECA MARFIL ivory knife, couteau ivoire, coltello avorio, elfenbeinmesser	0,65 €	0/12/288/6336/19008	288	200	
E 3006 CHULETERO ECO eco steak knife, couteau steak eco, coltello bistecca eco, steakmesser eco	0,76 €	0/6/144/2304/6912	144	220	
F 7777 CUCHILLO PIZZA ECO pizza knife eco, couteau pizza eco, coltello pizza eco, pizza tafelmesser eco	0,76 €	0/6/144/?/?	144	220	
G 7787 CHULETERO CLASICO ECO steak knife classic eco, couteau steak classic eco, coltello bistecca classic eco, steakmesser classic eco	3,08 €	0/6/144/?/?	144	220	
H 7788 CUCHILLO PIZZA CLASICO ECO pizza knife classic eco, couteau pizza classic eco, coltello pizza classic eco, pizza tafelmesser classic eco	3,08 €	0/6/144/?/?	144	220	



A



B



C



D



E



F



G



H

	€	UE	MOQ	✂ mm
A F02004 PALA MANTEQUILLA MANGO PLASTICO 0.9MM plastic handle 0.9mm butter server, pelle beurre manche plastique 0.9mm, pala burro manico plastica 0.9mm, plannenwender butter plastik griff 0.9mm	1,03 €	1/24/480/1920/3840	24	160
B F02005 BLISTER CUCHILLO CHULETERO MANGO PLASTICO 0.9MM SIERRA FINA plastic handle 0.9mm small blade steak knife blister, blister couteau steak manche plastique 0.9mm fin lame, blister coltello bistecca manico plastica 0.9mm sottile lame, blister messer steak plastik griff 0.9mm dünn Klinge	1,06 €	1/24/480/1920/3840	24	200
C F02008 BLISTER CUCHILLO CHULETERO MANGO PLASTICO 0.9MM SIN SIERRA plastic handle 0.9mm sharp blade steak knife blister, blister couteau steak manche plastique 0.9mm filo, blister coltello bistecca manico plastica 0.9mm filo, blister steakmesser plastik griff 0.9mm filo	1,06 €	1/24/480/1920/3840	24	200
D F03044 BLISTER CUCHILLO CHULETERO MANGO PLASTICO 0.9MM MARRÓN plastic handle 0.9mm brown steak knife blister, blister couteau steak manche plastique 0.9mm marron, blister coltello bistecca manico plastica 0.9mm marrone, blister messer steak plastik griff 0.9mm braun	1,01 €	1/24/480/1920/3840	24	215
E F03045 BLISTER TENEDOR MESA MANGO PLASTICO 1.0MM MARRÓN plastic handle 1.0mm brown table fork blister, blister fourchette table manche plastique 1.0mm marron, blister forchetta tavola manico plastica 1.0mm marrone, blister gabel tafel plastik griff 1.0mm braun	1,13 €	1/24/480/1920/1920	24	200
F F03067 BLISTER CUCHARA MESA MANGO PLASTICO 1.0MM MARRÓN plastic handle 1.0mm brown table spoon blister, blister cuillère table manche plastique 1.0mm marron, blister cucchiaio tavola manico plastica 1.0mm marrone, blister löffel tafel plastik griff 1.0mm braun	1,25 €	1/24/480/1920/1920	24	205
G F05025 BLISTER 2 CUCHILLO MANTEQUILLA MANGO PLASTICO 0.8MM plastic handle 0.8mm butter knife 2 blister, blister 2 couteau beurre manche plastique 0.8mm, blister 2 coltello burro manico plastica 0.8mm, blister 2 messer butter plastik griff 0.8mm	2,04 €	1/12/144/1152/2304	12	220
H F09009 CUCHILLO PATATERO MANGO PLASTICO 0.9MM plastic handle 0.9mm paring knife, couteau à épilucher manche plastique 0.9mm, coltello spelucchino manico plastica 0.9mm, messer tournier plastik griff 0.9mm	0,96 €	1/24/480/2400/4800	24	164



		€	UE	MOQ	✂ mm
A	F02009 BLISTER PALA MANTEQUILLA MANGO MADERA 0.9MM ash wood handle 0.9mm butter server blister, blister pelle beurre boise manche 0.9mm, blister pala burro legno manico 0.9mm, blister pfannenwender butter holz greff 0.9mm	1,13 €	1/24/480/1920/3840	24	170
A	F02009A BLISTER 2 PALA MANTEQUILLA MANGO MADERA 0.9MM ash wood handle 0.9mm butter server 2blister, blister 2 pelle beurre boise manche 0.9mm, blister 2 pala burro legno manico 0.9mm, blister 2 pfannenwender butter holz greff 0.9mm	2,21 €	1/12/144/1152/2304	12	170
B	F02010 BLISTER CUCHILLO CHULETERO MANGO MADERA 0.9MM SIERRA FINA ash wood handle 0.9mm small blade steak knife blister, blister couteau steak boise manche 0.9mm fin lame, blister coltello bistecca legno manico 0.9mm sottile lame, blister messer steak holz greff 0.9mm dünn klinge	1,15 €	1/24/480/1920/3840	24	205
B	F02010A BLISTER 2 CUCHILLO CHULETERO MANGO MADERA 0.9MM SIERRA FINA ash wood handle 0.9mm small blade steak knife 2 blister, blister 2 couteau steak boise manche 0.9mm fin lame, blister 2 coltello bistecca legno manico 0.9mm sottile lame, blister 2 messer steak holz greff 0.9mm dünn klinge	2,26 €	1/12/144/1152/2304	12	205
C	F02012 BLISTER CUCHILLO CHULETERO MANGO MADERA 0.9MM SIERRA LASER ash wood handle 0.9mm laser blade steak knife blister, blister couteau steak boise manche 0.9mm laser lame, blister coltello bistecca legno manico 0.9mm laser lame, blister messer steak holz griff 0.9mm laser klinge	1,15 €	1/24/480/1920/3840	24	205
C	F02012A BLISTER 2 CUCHILLO CHULETERO MANGO MADERA 0.9MM SIERRA LASER ash wood handle 0.9mm laser blade steak knife 2 blister, blister 2 couteau steak boise manche 0.9mm laser lame, blister 2 coltello bistecca legno manico 0.9mm laser lame, blister 2 messer steak holz greff 0.9mm laser klinge	2,26 €	1/12/144/1152/2304	12	205
D	F02013 BLISTER CUCHILLO CHULETERO MANGO MADERA 0.9MM SIN SIERRA ash wood handle 0.9mm sharp blade steak knife blister, blister couteau steak boise manche 0.9mm filo, blister coltello bistecca legno manico 0.9mm filo, blister steakmesser holz greff 0.9mm filo	1,15 €	1/24/480/1920/3840	24	205
D	F02013A BLISTER 2 CUCHILLO CHULETERO MANGO MADERA 0.9MM SIN SIERRA ash wood handle 0.9mm sharp blade steak knife 2 blister, blister 2 couteau steak boise manche 0.9mm non dentelé, blister 2 coltello bistecca legno manico 0.9mm non dentellata, blister 2 messer steak holz greff 0.9mm nicht gezacht	2,26 €	1/12/144/1152/2304	12	205
E	F03023 BLISTER CUCHILLO CHULETERO MANGO MADERA 0.9MM ash wood handle 0.9mm steak knife blister, blister couteau steak boise manche 0.9mm, blister coltello bistecca legno manico 0.9mm, blister messer steak holz greff 0.9mm	1,20 €	1/24/480/1920/3840	24	215
F	F03024 BLISTER TENEDOR MESA MANGO MADERA 1.0MM ash wood handle 1.0mm table fork blister, blister fourchette table boise manche 1.0mm, blister forchetta tavola legno manico 1.0mm, blister gabel tafel holz greff 1.0mm	1,35 €	1/24/480/1920/1920	24	195
G	F03025 BLISTER CUCHARA MESA MANGO MADERA 1.0MM ash wood handle 1.0mm table spoon blister, blister cuillère table boise manche 1.0mm, blister cucchiaino tavola legno manico 1.0mm, blister löffel tafel holz greff 1.0mm	1,26 €	1/24/480/1440/1440	24	195
H	F06061 BLISTER ABRELATAS MANGO MADERA ash wood handle bottle opener blister, ouvre-boîte boise manche, blister apriscatole legno manico, blister flaschenöffner holz greff	1,59 €	1/24/240/1920/1920	24	195
I	F07008 BLISTER CORTA PIZZA MANGO MADERA ash wood handle pizza cutter blister, blister coupe pizza boise manche, blister pizza taglierina legno manico, blister pizza schneider holz greff	2,21 €	1/12/144/864/1728	12	196
J	F09014 BLISTER CUCHILLO PATATERO MANGO MADERA 0.9MM ash wood handle 0.9mm paring knife blister, blister couteau à éplucher boise manche 0.9mm, blister coltello spelucchino legno manico 0.9mm, blister messer tournier holz griff 0.9mm	1,13 €	1/24/480/1920/3840	24	180
J	F09014A BLISTER 2 CUCHILLO PATATERO MANGO MADERA 0.9MM ash wood handle 0.9mm paring knife 2 blister, blister 2 couteau à éplucher boise manche 0.9mm, blister 2 coltello spelucchino legno manico 0.9mm, blister 2 messer tournier holz griff 0.9mm	2,21 €	1/12/144/1152/2304	12	180
K	F10025 BLISTER CUCHILLO JAMONERO MANGO MADERA 1.2MM ash wood handle 1.2mm ham slicer knife blister, blister couteau à jambon boise manche 1.2mm, blister coltello prosciutto legno manico 1.2mm, blister messer schinken holz griff 1.2mm	2,88 €	1/12/144/576/1152	12	370
L	F11042 BLISTER CUCHILLO VERDULERO MANGO MADERA 1.8MM ash wood handle 1.8mm chef knife blister, blister couteau de chef boise manche 1.8mm, blister coltello dello chef legno manico 1.8mm, blister kochmesser holz griff 1.8mm	2,64 €	1/12/144/576/1152	12	325
M	FAE202 BLISTER CUCHILLO CARNE MANGO MADERA 1.8MM ash wood handle 1.8mm carving knife blister, blister couteau à viande boise manche 1.8mm, blister coltello carne legno manico 1.8mm, blister bratenmesser holz griff 1.8mm	3,36 €	1/12/144/576/1152	12	310
N	F05032 BLISTER ESPÁTULA MANGO PLASTICO 1.0MM plastic handle 1.0mm spatula blister, blister spatule manche plastique 1.0mm, blister spatola manico plastica 1.0mm, blister bratenheber plastik griff 1.0mm	1,97 €	1/24/240/1440/1440	24	198







Acabado Finish

Escoge el acabado que prefieras para cualquier colección del catálogo.
Choose the finish you prefer for any collection in the catalogue.



VINTAGE

Aspecto antiguo y desgastado que proporciona elegancia a la pieza. Efecto envejecido.

Ancient and worn aspect that gives elegance to the piece. Aged effect.

MOQ
1.080 u./ MIX



ICE

Efecto granulado "sandblasting". Acabado mate, suave y liso, que resalta la delicadeza de cada pieza.

"Sandblasting" effect. A matt and smooth finish that stand out the delicacy of every piece.

MOQ
1.080 u./ MIX



SATIN

Este tratamiento regala al cubierto un efecto satinado agradable al tacto.

This treatment gives the cover a satin effect pleasant to the touch.

MOQ
1.080 u./ Item



MIRROR

El acabado más extremo, efecto espejo, sumará elegancia y sofisticación a la mesa.

The most extreme finish, mirror effect, will add elegance and sophistication to the table.

MOQ
1.080 u./ MIX

Plazo entrega 30 días. Delivery time 30 days.

Personaliza la cubertería con el color que prefieras, y busca ese toque que hará destacar tu mesa.
 Personalize the cutlery with the color you prefer, and look for that touch that will make your table stand out.



CHAMPAGNE

La elegancia llevada al color.
 Elegance brought to colour.



GOLD

Sofisticación en estado puro.
 Pure sophistication.



COPPER

El toque industrial que necesitas.
 The industrial touch you need.



BLACK

El color de moda para vestir tu mesa.
 The fashionable color to dress your table.



GUNMETAL

Un color atrevido y elegante.
 A dared and elegant color.

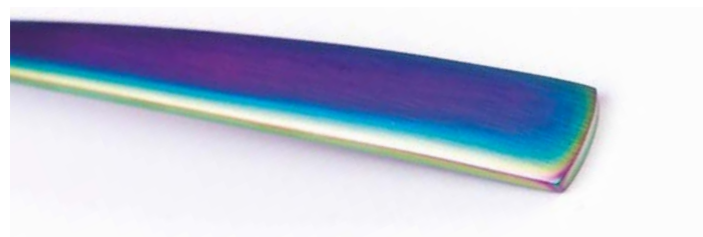

RAINBOW

Un efecto original y desenfadado.
 An original and casual effect.

Acabados aplicables a cualquier modelo del catálogo.
 Finishes applicable to any model in the catalogue.

VINTAGE



ICE



SATIN



MIRROR



Certificado SGS de calidad.
 SGS Quality Certificate.



Garantizado para el contacto con alimentos.
 Guaranteed for contact with food.



Garantizado el lavado en lavavajillas.
 Guaranteed dishwashing.



PVD

La tecnología de revestimiento decorativo de PVD (Physical Vapor Deposition) consiste en un revestimiento fino (de entre 0,4 a 1,5mm) de cerámica que se deposita en el cubierto por plasma altamente ionizado en una cámara de alto vacío. Esta técnica de revestimiento se puede aplicar a todos los modelos que tengan un acabado mate o brillante.

Antialérgico: El revestimiento PVD protege del contacto directo con el sustrato, evitando así reacciones alérgicas a diferentes componentes como el níquel.

Biocompatible: Se reduce significativamente la adhesión y proliferación bacteriana.

Resistencia: Aumenta la resistencia al desgaste y a la corrosión y, en consecuencia, la vida útil de las piezas.

Ecológico: Procedimiento no contaminante. Revestimiento ecológico.

Physical Vapor Deposition (PVD) is a thin (0.4-1.5 mm) layer of ceramic deposited on the cutlery by highly ionised plasma in a high-vacuum chamber.

This coating technique can be used for all products that have a matt or gloss finish.

Antiallergic: a PVD layer protects against direct contact with the substrate and so avoids allergic reaction to components like nickel.

Biocompatible: PVD significantly reduces the adherence and proliferation of bacteria.

Resistance: Reduces wear and tear and corrosion and hence the useful life of cutlery.

Ecological: Non-polluting process. Eco-friendly coating.

CUIDADOS

CARE

Recomendaciones de uso de cubiertos con PVD:

- Las piezas PVD deben lavarse a máquina.
- No usar ningún agente abrasivo o mecánico abrasivo (scotch-brite, esponja, paño abrasivo)
- No usar ningún químico corrosivo o detergente que los contenga.
- Usar un programa de lavado a temperatura inferior a 80°C y detergente con fosfatos en cantidad inferior al 10%.

Recomendaciones para el mantenimiento de cubiertos PVD:

- Se debe tratar de evitar los golpes por caída o lanzamiento del cubierto al lavavajillas
- La limpieza en lavavajillas se debe realizar en posición vertical
- En caso de que la limpieza no se lleve a cabo en posición vertical, el secado del cubierto se deberá reparar a mano con un paño.

El recubrimiento PVD garantiza una resistencia de hasta 500 ciclos de lavado.

How to use cutlery coated using PVD:

- PVD pieces should be washed in the dishwasher.
- Don't use anything abrasive (scourer, sponge, rough cloths)
- Don't use any corrosive chemicals or detergents that contain corrosive chemicals.
- Use a wash programme below 80°C and detergent with phosphate content below 10%.

How to maintain PVD cutlery:

- Avoid impacts from dropping the cutlery or throwing it into the dishwasher
- Stand the cutlery upright in the dishwasher
- If the cutlery is not completely clean after being washed standing up, dry by hand with a cloth.

The PVD coating guarantees a resistance of up to 500 washing cycles.



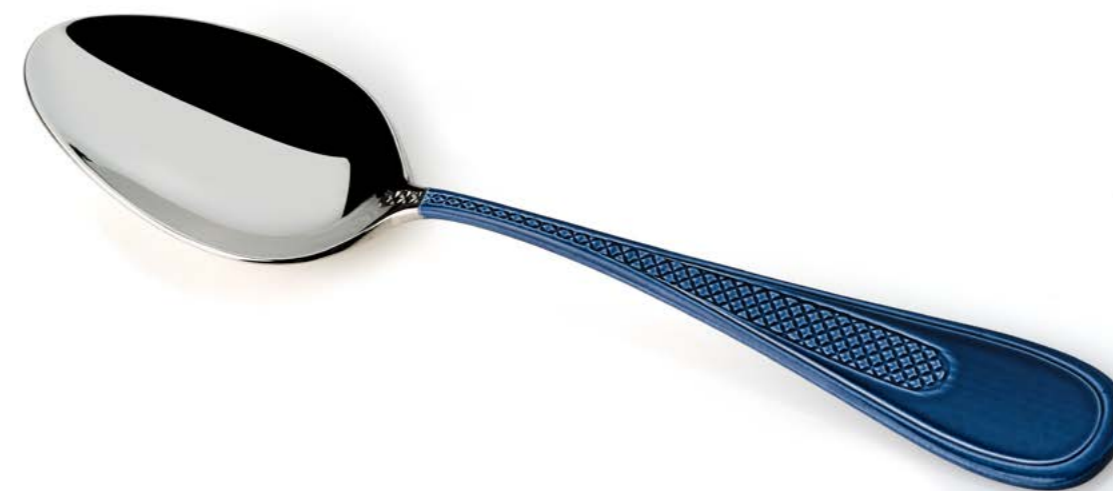

VERDE LISO



FUCSIA LISO



ROJO LISO



GRIS LISO



ROSA LISO



AMARILLO FLUOR



NARANJA FLUOR



DENIM

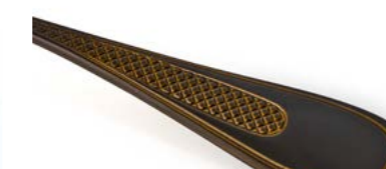

TIERRA



SPIDER ULTRAVIOLETA
ROJO



SPIDER ULTRAVIOLETA
GRIS



AZUL BRILLO



ROJO BRILLO

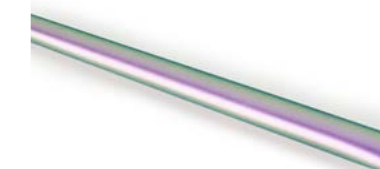

PLATEADO



TORNASOLADO

Pintura plástica biocompatible aplicada de forma tradicional, con un pretratamiento que permite pintar las piezas en cualquier color Pantone.

La aplicación de este acabado es válida para cualquier modelo, así como para los utensilios.

Biocompatible plastic paint applied in the traditional way, with a pre-treatment that allows the pieces to be painted in any Pantone colour.

The application of this finish is valid for any model, as well as for utensils.

Otros acabados Other finishes

Precios Prices



SILVER PLATE

Dale un toque de distinción a tus cubiertos añadiendo un acabado en plata.

Add a touch of distinction to your cutlery by adding a silver plated.



LASER MARK

Escoge la cubertería y customiza con tu logo cada una de las piezas.





Choose the cutlery and customize each piece with your logo.



TAMPO

Personaliza con los motivos que prefieras las piezas de tu cubertería.

Personalize with the motives that you prefer the pieces of your cutlery.

	ACABADO	MOQ	€
	VINTAGE	1080 u. / MIX	1,25 € / pieza + PVD STEEL
	ICE	1080 u. / MIX	1,25 € / pieza + PVD STEEL
	SATIN	1080 u. / ITEM	1,25 € / pieza
	MIRROR	1080 u. / ITEM	1,25 € / pieza
		120 u. / ITEM	0 € / pieza estándar catálogo

	PVD COLOR	MOQ	€
	STEEL*	1080 u. / MIX	5 € / pieza
	CHAMPAGNE	1080 u. / MIX	5 € / pieza
	GOLD	1080 u. / MIX	5 € / pieza
	COPPER	1080 u. / MIX	5 € / pieza
	GUNMETAL	1080 u. / MIX	5 € / pieza
	BLACK	1080 u. / MIX	5 € / pieza
	RAINBOW	1080 u. / MIX	5 € / pieza

	RECUBRIMIENTO / COATING	MOQ	€
	CUALQUIER RECUBRIMIENTO ANY COATING	360 u. / COLOR	4,95 € / pieza



	SILVER PLATE	MOQ	€
	PLATA	1080 u. / MIX	5 € / pieza



	LASER	€
	120 pcs	1,54 € / pieza
	360 pcs	1,46 € / pieza
	1.200 pcs	1,15 € / pieza
	3.600 pcs	0,77 € / pieza
	7.200 pcs	0,69 € / pieza
	15.000 pcs	0,58 € / pieza

50 € / diseño logotipo



	TAMPO	MOQ	€
	1 COLOR	1080 u. / MIX	0,38€ / pieza
	2 COLORES	1080 u. / MIX	0,75 € / pieza

140 € / precio fotolito

Cocina

Kitchen

COCINA KITCHEN

232-257 CORTE

- 234 TABLAS DE CORTE
- 238 CUCHILLOS COCINA
 - 238 CARBON
 - 242 IBÉRICA
 - 244 PUNTILLAS
 - 246 MARBLE
- 250 ACCESORIOS
- 252 RALLADORES
- 256 ESPÁTULAS

258-271 UTENSILIOS

- 258 EMPLATADO
- 260 JUEGOS DE COCINA
 - 260 MONOBLOCK
 - 262 NYLON

270-285 PASTELERÍA

- 272 MOLDES (MARTELLATO)
- 278 MANGAS PASTELERAS (MARTELLATO)
- 280 RECIPIENTES POLIESTILENO (MARTELLATO)
- 282 COCCIÓN (RISOLI)

286-311 COCCIÓN

- 286 SARTENES PROFESIONALES
 - 290 ALUMINIO
 - 294 INOX
- 296 PAELLERAS
- 300 RISOLI

314-337 GASTRONORM

- 316 INOX 18/10 (MORIZA)
- 322 INOX 18 %
- 324 POLICARBONATO (MORIZA)
- 328 POLIPROPILENO (MORIZA)
- 332 HELADERÍA (MORIZA)
- 333 VASOS (MORIZA)





Carne cocinada
Cooked meat



Pescado
Fish



Aves
Poultry



Pan y lácteos
Bread and dairy



Fruta y vegetales
Vegetables + fruits



Carne
Meat



POLIETILENO 500 DE ALTA DENSIDAD DE ALTO PESO MOLECULAR (HD-HMW)

POLIETILENO 500 DE ALTA DENSIDAD DE ALTO PESO MOLECULAR (HD-HMW)

SUPERFICIE AUTOCICATRIZANTE
Más higiénica. Evita que se acumule suciedad y bacterias en los cortes.

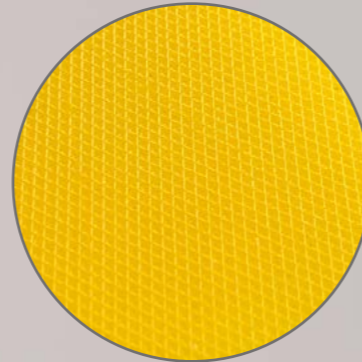

SELF-HEALING SURFACE.
More hygienic. Prevents the build-up of dirt and bacteria in cuts.



GRUESO
THICKNESS

2cm

Tacos antideslizantes de silicona para un mejor agarre en la superficie.

Anti-slip silicone pads for better surface grip.

Mayor rigidez. No se deforma con las altas temperaturas. Máx. 70°C

Stiffer. Does not deform in high temperatures. Max. 70 °C

Mayor resistencia a la abrasión.

More abrasion-resistant.



Tabla corte pan y lacteos blanca

White cutting board
Grattoir planche à découper
Tagliere bianca
Wibes schneidebrett



REF.	W(mm)	L(mm)	€	UE / MOQ
8522	GN 1/1	GN 1/1	34,76	1-0-5-0-0/1
8523	GN 1/2	GN 1/2	19,96	1-0-10-0-0/1
8525	200	300	13,64	1-0-10-0-0/1
8526	300	400	26,22	1-0-6-0-0/1
8527	300	500	33,64	1-0-6-0-0/1
8528	400	600	53,86	1-0-4-0-0/1

Tabla corte fruta y vegetales verde

Green cutting board
Planche à découper vert
Tagliere verde
Grün schneidebrett



REF.	W(mm)	L(mm)	€	UE / MOQ
8536	GN 1/1	GN 1/1	34,76	1-0-5-0-0/1
8539	200	300	13,64	1-0-10-0-0/1
8540	300	400	26,22	1-0-6-0-0/1
8541	300	500	33,64	1-0-6-0-0/1
8542	400	600	53,86	1-0-4-0-0/1

Tabla corte carne cruda aves amarilla

Yellow cutting board
Planche à découper jaune
Tagliere giallo
Gelb schneidebrett



REF.	W(mm)	L(mm)	€	UE / MOQ
8550	GN 1/1	GN 1/1	34,76	1-0-5-0-0/1
8553	200	300	13,64	1-0-10-0-0/1
8554	300	400	26,22	1-0-6-0-0/1
8555	300	500	33,64	1-0-6-0-0/1
8556	400	600	53,86	1-0-4-0-0/1

Tabla corte pescado azul

Blue cutting board
Planche à découper bleu
Tagliere blue
Blau schneidebrett



REF.	W(mm)	L(mm)	€	UE / MOQ
8529	GN 1/1	GN 1/1	34,76	1-0-5-0-0/1
8532	200	300	13,64	1-0-10-0-0/1
8533	300	400	26,91	1-0-6-0-0/1
8534	300	500	33,64	1-0-6-0-0/1
8535	400	600	53,86	1-0-4-0-0/1

Tabla corte carne cruda roja

Red cutting board
Planche à découper rouge
Tagliere rosso
Rot schneidebrett



REF.	W(mm)	L(mm)	€	UE / MOQ
8543	GN 1/1	GN 1/1	34,76	1-0-5-0-0/1
8546	200	300	13,64	1-0-10-0-0/1
8547	300	400	26,22	1-0-6-0-0/1
8548	300	500	33,64	1-0-6-0-0/1
8549	400	600	53,86	1-0-4-0-0/1

Tabla corte carnes guisadas marrón

Brown cutting board
Planche à découper marron
Tagliere marrone
Braun schneidebrett



REF.	W(mm)	L(mm)	€	UE / MOQ
8557	GN 1/1	GN 1/1	34,76	1-0-5-0-0/1
8560	200	300	13,64	1-0-10-0-0/1
8561	300	400	26,22	1-0-6-0-0/1
8562	300	500	33,64	1-0-6-0-0/1
8563	400	600	53,86	1-0-4-0-0/1

El afilado de las hojas hecho manualmente por un profesional es la manera de garantizar un afilado perfecto y duradero.

Blades sharpening is carried out manually by a professional in order to guarantee a perfect and durable sharpening.

La forma convexa de la hoja en ambas caras otorga a la hoja un grosor más continuado hasta el filo, garantizando una mayor firmeza en el corte. El pulido asegura un acabado liso e impecable.

The convex line of the blade on both sides grants the blade a more skiving continuing thickness up to the edge, ensuring a steadfast cutting. The polishing ensures a flawless flattening and finishing.

Mangos resistentes a esterilización y lavavajillas, de acuerdo con las normas HACCP, NSF y CE.

Handless resistant to sterilisation and washing machine, in accordance with the HACCP, NSF and CE standard.



Hojas fabricadas en acero inoxidable de alta calidad con molibdeno / vanadio, que con un correcto tratamiento térmico permite obtener una dureza de 55-57 HRC, ofreciendo una alta calidad en el corte, duración del filo y resistencia a la corrosión.

High quality stainless steel with molybdenum / vanadium, perfectly treated to give them a Hardness of 55-57 HRC, giving a strong cutting ability, a long lasting edge and resistant to corrosion.



Sello de calidad del fabricante y su compromiso de durabilidad y fiabilidad del producto.

Manufacturer's seal of quality and commitment to product durability and reliability.

TechFlex: Polímeros de PP con EVA para más sensibilidad, adherencia, confort y disminución de fatiga.

TechFlex: Polymers of PP with EVA for a more sensitivity, adhesion, comfort and decreased fatigue



La línea CARBON permite al usuario distinguir el cuchillo por colores según su necesidad para garantizar la seguridad en la preparación de los alimentos, evitando la contaminación alimentaria.

The CARBON line, allows its users to make the necessary distinction to ensure food safety when preparing or cutting food.



● 10074	Cuchillo chef 180	16,50€	UE / MOQ: 1-12-144-0-0 / 12
● 10093	Chef knife 180		
● 10104	Couteau de cuisine 180		
● 10114	Coltello chef 180		
● 10128	Kochmesser 180		



● 10075	Cuchillo chef 200	20,14€	UE / MOQ: 1-12-72-0-0 / 12
● 10094	Chef knife 200		
● 10105	Couteau de cuisine 200		
● 10115	Coltello chef 200		
● 10129	Kochmesser 200		



● 10076	Cuchillo chef 250	21,92€	UE / MOQ: 1-12-72-0-0 / 12
● 10095	Chef knife 250		
● 10106	Couteau de cuisine 250		
● 10116	Coltello chef 250		
● 10130	Kochmesser 250		



● 10077	Cuchillo chef 300	24,75€	UE / MOQ: 1-6-48-0-0 / 6
● 10096	Chef knife 300		
● 10107	Couteau de cuisine 300		
● 10117	Coltello chef 300		
● 10131	Kochmesser 300		

Cocina / Kitchen

Carbon / Carbon

Corte / Cuchillos de cocina
Cutting / Kitchen knives



- 10078
- 10097
- 10108
- 10118

Cuchillo deshuesador 140
Boning knife 140
Couteau de desossage 140
Coltello disossato 140
Ausbeinmesser 140

10,94€

UE / MOQ:
1-12-144-0-0 / 12



- 10079
- 10098
- 10109
- 10119

Cuchillo carnicero 160
Butcher knife 160
Couteau boucher 160
Coltello scannare 160
Fleischermesser 180

12,58€

UE / MOQ:
1-12-144-0-0 / 12



- 10084
- 10127

Cuchillo pan y pastelero 250
Bread and pastry knife 250
Couteau à pain et pâtisserie 250
Coltello pane 250
Brotmesser 250

15,57€

UE / MOQ:
1-12-72-0-0 / 12



- 10080
- 10099
- 10110
- 10120

Cuchillo carnicero 180
Butcher knife 180
Couteau boucher 180
Coltello scannare 180
Fleischermesser 180

14,36€

UE / MOQ:
1-12-144-0-0 / 12



- 10085
- 10124

Cuchillo para fiambres 300
Slicing knife 300
Couteau à charcuterie 300
Coltello affettati 300
Tranchiermesser 300

18,58€

UE / MOQ:
1-6-48-0-0 / 6



- 10081
- 10100
- 10111
- 10121

Cuchillo carnicero 200
Butcher knife 200
Couteau boucher 200
Coltello scannare 200
Fleischermesser 200

17,07€

UE / MOQ:
1-12-72-0-0 / 12



- 10086
- 10103
- 10125

Cuchillo salmón 300
Salmon knife 300
Couteau saumon 300
Coltello salmone 300
Lachsmesser 300

26,09€

UE / MOQ:
1-6-48-0-0 / 6



- 10082
- 10101
- 10112
- 10122

Cuchillo carnicero 240
Butcher knife 240
Couteau boucher 240
Coltello scannare 240
Fleischermesser 240

20,98€

UE / MOQ:
1-12-72-0-0 / 12



- 10087
- 10126

Cuchillo jamonero 280
Ham knife 280
Couteau à jambon 280
Coltello prosciutto 280
Schinkenmesser 280

17,43€

UE / MOQ:
1-6-48-0-0 / 6



- 10083
- 10102
- 10113
- 10123

Cuchillo carnicero 300
Butcher knife 300
Couteau boucher 300
Coltello scannare 300
Fleischermesser 300

24,95€

UE / MOQ:
1-6-48-0-0 / 6



- 10092

Cuchillo chuletero 130
Steak knife 130
Couteau à steak 130
Coltello per bistecca 130
Steakmesser 130

6,34€

UE / MOQ:
1-12-60-0-0 / 12



Los cuchillos de la línea IBÉRICA pueden ser utilizados para cortar o filetear gracias a su fino espesor.

Esta gama presenta un mango moderno, ergonómico y antideslizante que garantiza un mayor confort y seguridad en su uso.

The ibérica line cleavers can be used for various functions, including cutting and filleting due to their thin thickness. This line uses a modern, ergonomic and non-stick polypropylene handles in order to provide the greater comfort to its user.



Macheta 180
Cleaver 180
Couperet 180
Mannaietta 180
Hackmesser 180

REF.	HQ3A (mm)	L(mm)	€	UE / MOQ
● 10088	180/7"	300	41,34	1-12-12-0-0 / 12



Hachuela 250
Cleaver 250
Couperet 250
Mannaietta 250
Hackmesser 250

REF.	HQ3A (mm)	L(mm)	€	UE / MOQ
● 10089	250/10"	345	63,93	1-12-12-0-0 / 12



Macheta filetera 220
Fillets cleaver 220
Couperet filet 220
Mannaietta per affettare 220
Filetirmesser 220

REF.	HQ3A (mm)	L(mm)	€	UE / MOQ
● 10090	220/8'6"	315	28,08	1-6-6-0-0 / 6



Macheta filetera 280
Fillets cleaver 280
Couperet filet 280
Mannaietta per affettare 280
Filetirmesser 280

REF.	HQ3A (mm)	L(mm)	€	UE / MOQ
● 10091	280/11"	362	32,43	1-6-6-0-0/6



Cuchillo multiusos.
Micro serrated knife.



Cuchillo pelador.
Paring knife.



Cuchillo chuletero.
Steak knife.



Cuchillo fruta micro.
Micro serrated fruit knife.



Cuchillo chuletero rojo
Red steak knife
Couteau steak rouge
Coltello bistecca rosso
Steakmesser rot

REF.	HQ3A (mm)	L (mm)	€	UE / MOQ
7535	120	230	3,03	1-24-240-7200-21600 / 24



Cuchillo multiusos micro azul
Blue micro serrated utility knife
Couteau multi-usage micro bleu
Coltello multiuso micro blu
Universalmesser micro blau

REF.	HQ3A (mm)	L (mm)	€	UE / MOQ
7537	100	209	3,12	1-24-240-7200-21600 / 24

sierra microdentada
micro toothed saw



Cuchillo fruta micro amarillo
Yellow micro serrated fruit knife
Couteau à fruits micro jaune
Coltello fruta micro giallo
Universalmesser obst micro gelb

REF.	HQ3A (mm)	L (mm)	€	UE / MOQ
7538	88	199	3,03	1-24-240-7200-21600 / 24

sierra microdentada
micro toothed saw



Cuchillo pelador verde
Green paring knife
Couteau à éplucher vert
Coltello spellucchino verde
Schälmesser grün

REF.	HQ3A (mm)	L (mm)	€	UE / MOQ
7536	80	195	2,89	1-24-240-7200-21600 / 24



PACKAGING
BLISTER

Blister



Blister 2 cuchillos
Blister 2 knives
Blister 2 couteaux
Blister 2 coltelli
Blister 2 messern

REF.	PACK	€	MOQ
8301	A	6,83	24
8302	B	6,55	24
8303	C	7,01	24
8304	D	6,83	24



FILO: Afilado en "V" para una mejor precisión en el corte.

EDGE: With "V"-grind for a finer cut.

HOJA: Fabricado con acero alemán de alta calidad: DIN1.4116 / HRC55±2.

BLADE: Made with high-quality German steel: DIN1.4116 / HRC55±2.

Proceso de endurecimiento de la hoja en frío para un afilado duradero y resistente al óxido.

Cold-hardened blade for a long-lasting, rust-free grind.

REFUERZO: Cabezal cónico para un agarre cómodo y seguro.

REINFORCEMENT: Cone-shaped bolster for a comfortable, secure grip.

MANGO: Diseño ergonómico para un mejor agarre, proporcionando el equilibrio perfecto en la sujeción del cuchillo.

HANDLE: Ergonomically designed for better grip, giving perfect balance in the hand.



PACKAGING BOX

Remaches resistentes a la corrosión. Fabricado en ABS, le proporciona una mayor dureza y una alta resistencia al calor.

Rust-resistant rivets. Made from boron steel which makes it tougher and more heat resistant.

Talón acabado en acero inoxidable que proporciona protección y mayor robustez al mango.

Butt finished in stainless steel to provide protection and make the handle more durable.

Cocina / Kitchen

Marble / Marble

Corte / Cuchillos de cocina
Cutting / Kitchen knives



Cuchillo chef 20
Chef knife 20
Couteau de cuisine 20
Coltello chef 20
Kochmesser 20

REF.	HOJA (mm)	L (mm)	€	UE / MOQ
8108	200/8"	320	28,66	1-6-36-144-432 / 6



Cuchillo chef 25
Chef knife 25
Couteau de cuisine 25
Coltello chef 25
Kochmesser 25

REF.	HOJA (mm)	L (mm)	€	UE / MOQ
8117	250/10"	380	30,10	1-6-36-144-432 / 6



Cuchillo mini Santoku
Mini Santoku knife
Couteau mini Santoku
Coltello mini Santoku
Mini Santoku messer

REF.	HOJA (mm)	L (mm)	€	UE / MOQ
8112	125/5"	230	17,85	1-6-48-192-384 / 6



Cuchillo verduras
Utility knife
Couteau à légumes
Coltello multiuso
Universalmesser

REF.	HOJA (mm)	L (mm)	€	UE / MOQ
8113	125/5"	230	15,52	1-6-48-192-384 / 6



Cuchillo fileteador
Carving knife
Couteau à filet
Coltello per affettare
Tranchiermesser

REF.	HOJA (mm)	L (mm)	€	UE / MOQ
8109	200/8"	320	22,65	1-6-36-144-432 / 6



Cuchillo panero
Bread knife
Couteau à pain
Coltello pane
Brotmesser

REF.	HOJA (mm)	L (mm)	€	UE / MOQ
8110	200/8"	320	23,07	1-6-36-144-432 / 6



Cuchillo chuletero
Steak knife
Couteau à steak
Coltello per bistecca
Steakmesser

REF.	HOJA (mm)	L (mm)	€	UE / MOQ
8114	115/4,5"	220	15,52	1-6-48-192-384 / 6



Cuchillo Mondador
Paring knife
Couteau d'office
Coltello sbucciatore
Schälmesser

REF.	HOJA (mm)	L (mm)	€	UE / MOQ
8115	80/3,5"	190	15,52	1-6-48-192-384 / 6



Cuchillo Santoku
Santoku knife
Couteau Santoku
Coltello Santoku
Santoku messer

REF.	HOJA (mm)	L (mm)	€	UE / MOQ
8111	180/7"	300	28,80	1-6-36-144-432 / 6



Cuchillo jamonero
Slicing knife
Couteau à jambon
Coltello da prosciutto
Schinkenmesser

REF.	HOJA (mm)	L (mm)	€	UE / MOQ
8116	260/10"	385	24,05	1-6-36-144-432 / 6



Cuchillo deshuesador
Boning knife
Couteau de désossage
Coltello disossato
Ausbeinmesser

REF.	HOJA (mm)	L (mm)	€	UE / MOQ
8118	200/7,8"	280	19,81	1-6-36-144-432 / 6



Chaira
Sharpening stell
Fusil
Acciaini
Skärpstål

REF.	HOJA (mm)	L (mm)	€	UE / MOQ
8119	200/7,8"	325	12,11	1-6-36-144-432 / 6



Imán madera
Wood magnetic bar
Porte-couteaux magnetic
Barra magnetica legno
Magnet-messerhalter Holz

REF.	L(mm)	H(mm)	€	UE / MOQ
8471	460	67	38,17	1-6-12-144-432 / 6



Imán inox
Magnetic bar inox
Porte-couteaux magnetic inox
Barra magnetica inox
Magnet-messerhalter inox

REF.	L(mm)	H(mm)	€	UE / MOQ
8470	350	47	34,96	1-6-12-144-432 / 6



Imán PP
PP magnetic bar
Porte-couteaux magnetic PP
Barra magnetica PP
Magnet-messerhalter PP

REF.	L(mm)	H(mm)	€	UE / MOQ
8472	550	50	13,01	1-6-12-144-432 / 6



Afilador mango
Two stage knife sharpener
Affûteur couteau
Arrotino
Messerschärfer mit griff

REF.	L(mm)	€	UE / MOQ
6957	190	10,45	1-0-36-180-360 / 6

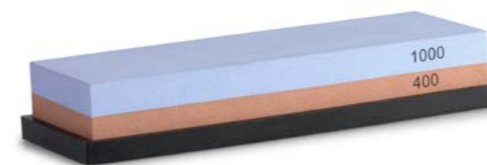

Piedra afilar
Whetstone
Pierre à aiguiser
Cote
Messerschärfer stein

REF.	L(mm)	€	UE / MOQ
6958	180	29,02	1-0-16-176-528 / 2



Afilador ventosa 3 filas
3 Stage suction knife sharpener
Affûteur à ventouse
Affilatore
Messerschärfer mit saugnapf

REF.	L(mm)	€	UE / MOQ
7460	145	7,26	0-2-20-480-960 / 2

INOX AISI 304

Acero inoxidable de alta resistencia al desgaste y la corrosión.

INOX AISI 304

Stainless steel highly resistant to wear and rust.

Mango fabricado en caucho termoplástico. Antideslizante.

Handle made in thermoplastic rubber. Anti-slip.



Rallador WIDE extra fino
St. Steel "wide" grater extra-thin
Râpe en inox coupe ultra fine
Grattugia taglio superfine
Rostfreie reibe breit extra fein

REF.	L HOJA	L TOTAL	€	UE / MOQ
8946	135	320	7,32	1-6-96-0-0 / 6

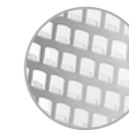

Rallador WIDE fino
St. Steel "wide" grater thin
Râpe en inox coupe fine
Grattugia taglio fine
Rostfreie reibe breit fein

REF.	L HOJA	L TOTAL	€	UE / MOQ
8947	135	320	7,32	1-6-96-0-0 / 6

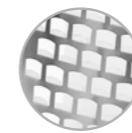

Rallador WIDE grueso
St. Steel "wide" grater extra coarse
Râpe en inox coupe épaisse
Grattugia taglio spesso
Rostfreie reibe breit grob

REF.	L HOJA	L TOTAL	€	UE / MOQ
8948	135	320	7,32	1-6-96-0-0 / 6



Rallador WIDE tiras largas
St. Steel "wide" grater large shaver
Râpe en inox coupe julienne
Grattugia taglio julienne
Rostfreie reibe breit lange streifen

REF.	L HOJA	L TOTAL	€	UE / MOQ
8949	135	320	7,32	1-6-96-0-0 / 6

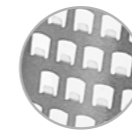

Rallador SLIM fino
St. Steel lengthways grater thin
Râpe longue en inox coupe fine
Grattugia lunga taglio fine
Rostfreie reibe schmal fein

REF.	L HOJA	L TOTAL	€	UE / MOQ
8950	220	410	7,32	1-6-96-0-0 / 6

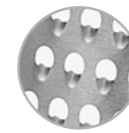

Rallador SLIM medio redondo
St. Steel lengthways grater medium
Râpe longue en inox coupe redondo moyen
Grattugia lunga taglio mezzo giro
Rostfreie reibe schmal medium

REF.	L HOJA	L TOTAL	€	UE / MOQ
8951	220	410	7,32	1-6-96-0-0 / 6

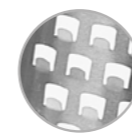

Rallador SLIM grueso
St. Steel lengthways grater extra coarse
Râpe longue en inox coupe épaisse
Grattugia lunga taglio spesso
Rostfreie reibe schmal grob

REF.	L HOJA	L TOTAL	€	UE / MOQ
8952	220	410	7,32	1-6-96-0-0 / 6

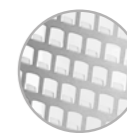

Rallador SLIM dual
St. Steel lengthways grater dual
Râpe longue en inox coupe dual
Grattugia lunga taglio dual
Rostfreie reibe schmal doppel

REF.	L HOJA	L TOTAL	€	UE / MOQ
8953	220	410	7,32	1-6-96-0-0 / 6

Se presenta con una funda de plástico para proteger la zona de corte

Comes with a plastic sheath to protect the cutting edge

Mango ergonómico

Ergonomic handle



Acero inoxidable resistente al desgaste y la corrosión.

Wear and corrosion resistant stainless steel.



Grueso Coarse **Fino** Fine **Medio** Medium **Rebanador** Slicer

Rallador 4 caras HQ

4 side grater HQ
Rape 4 cotés HQ
Grattugia 4 facce HQ
Reibe, 4-seiting HQ

REF.	L(mm)	€	UE / MOQ
7448	240	7,13	1-12-72-288-288 / 6

Rallador
Grater
Râpes
Grattugia
Reibe



REF.	MODEL	L(mm)	€	UE / MOQ
1405	TRIPLE	280	4,71	1-0-60-720-2160 / 12
1407	GRUESO	280	4,39	1-0-60-720-2160 / 12
1408	FINO	280	4,39	1-0-60-720-2160 / 12

Rallador Graziella colores
Graziella colour grater
Râpe couleur graziella
Grattugia graziella
Farbige reiben



REF.	L(mm)	€	UE / MOQ
1411	235	5,59	1-0-48-192-192 / 6

Rallador 4 caras
4 side grater
Râpe 4 faces
Grattugia 4 lam.
4-seitige reibe



REF.	L(mm)	€	UE / MOQ
1150	210	5,38	1-0-60-240-720 / 6

Pelapatatas
Potato-peeler
Économe acier inox
Pelapatate
Kartoffelschäler



REF.	L(mm)	€	UE / MOQ
3455	110	3,30	0-0-12-120-480 / 12

Tenedor marisco
Shellfish fork
Fourchette crustacé
Forchetta crostacei
Fischgabel



REF.	L(mm)	€	UE / MOQ
5099	220	2,71	0-12-120-3000-15k / 12

Pinza rompe marisco
Lobster cracker
Pince homard
Pinza per aragosta
Hummerzange



REF.	L(mm)	€	UE / MOQ
0738	190	16,31	1-5-50-350-1400 / 12

Acero inoxidable AISI 420-4034

Stainless steel

HRc 56 Rockwell

Microdentada

Micro-Toothed

Forjada en caliente

Hot forged

Diseño ergonómico

Ergonomic design

Todo tipo de alimentos

All types of food



Tijera profesional 8"
Scissors prof. Inox 8"
Ciseaux prof. Acier 8"
Forbice prof. Acciaio 8"
Schere prof. Stahl 8"

NEW

REF.	L(mm)	€	UE / MOQ
5164	160	77,68	1-0-6-84-588 / 1



Tijera master 8"
Scissors master inox 8"
Ciseaux master acier 8"
Forbice master acciaio 8"
Schere master stahl 8"

NEW

REF.	L(mm)	€	UE / MOQ
5165	220	60,51	1-0-6-84-588 / 1

Tijera cocina 8,5
Kitchen scissors 8,5
Ciseaux cuisine 8,5
Forbice multiuso 8,5
Küchenschere 8,5

REF.	L(mm)	€	UE / MOQ
8988	210	7,04	1-12-96-0-0 / 12

Tijera para aves
Poultry shears
Coupe volailles
Trinciapollo
Geflügelschere

REF.	L(mm)	€	UE / MOQ
8989	200	17,40	1-6-36-0-0 / 6

Cascanueces
Nut cracker
Case-noix
Rompinoci
Nussknacker



REF.	L(mm)	€	UE / MOQ
3623	160	16,31	1-10-50-900-2700 / 10

Tijera cocina inox
Kitchen scissors
Ciseaux de cuisine
Forbici cucina
küchenschere

REF.	L(mm)	€	UE / MOQ
3910	220	23,24	1-12-48-1080-3240 / 12



PASTELERÍA
PASTRY

Espátula pastelera

Baker spatula
Palette
Spatola cuoco
Kuchenspachtel



REF.	SIZE	HOJA (mm)	€	UE / MOQ
8932	S	135	2,16	1-12-48-0-0 / 12
8933	M	225	2,44	1-12-48-0-0 / 12
8934	L	300	3,05	1-12-48-0-0 / 12



PASTELERÍA
PASTRY

Pala repostería

Cake server
Pelle à gâteau
Spatola dolci
Keksschaufel



REF.	W (mm)	€	UE / MOQ
8941	120	2,67	1-12-48-0-0 / 12



PLANCHA
GRILL

Espátula plancha rectangular biselada

Solid, beveled turner
Palette pleine, biseauté
Spatola hamburger
Bratenwender



REF.	W (mm)	H (mm)	€	UE / MOQ
8935	80	120	3,61	1-12-48-0-0 / 12



PLANCHA
GRILL

Espátula flexible acodada

Angular spatula
Palette coudée
Spatola cuoco con scalino
Confiseriepalette



REF.	SIZE	HOJA (mm)	€	UE / MOQ
8938	S	140	2,67	1-12-48-0-0 / 12
8937	L	200	2,82	1-12-48-0-0 / 12

Mango de polipropileno (PP) de forma redondeada para una sujeción más cómoda.

Rounded polypropylene (PP) handle for a more comfortable grip.

Piezas aptas para lavavajillas.

Dishwasher safe.

Alta resistencia a la corrosión.

Highly rust-resistant.

Pala fabricada en Acero inoxidable endurecido de alta calidad.

Spatula in high-quality hardened stainless steel.

Acabado satinado.

Satin finished.

Resistencia y flexibilidad para facilitar el trabajo en la cocina.

Hard-wearing and versatile round the kitchen.



PLANCHA
GRILL

Paleta plancha triangular

Cleaning spatula
Palette triangle
Spatola triangolare
Bratenspachtel



REF.	SIZE	HOJA (mm)	€	UE / MOQ
8939	S	80	2,86	1-12-48-0-0 / 12
8940	L	100	2,95	1-12-48-0-0 / 12



PLANCHA
GRILL

Espátula pescado biselada

Fish turner
Palette poisson
Spatola pesce
Fischschaufel



REF.	W (mm)	H (mm)	€	UE / MOQ
8936	75	165	4,22	1-12-48-0-0 / 12



PACKAGING
BLISTER



Espatula pescado

Spatula fish
Spatule poisson
Pesce spatola
Spatel fisch



REF.	W (mm)	L (mm)	€	UE / MOQ
9996	80	235	3,05	1-12-48-384-768 / 1



Rasqueta plancha profesional 30cm

Professional scraper
Racleur professionnelle
Raschietti
Schaber

REF.	L (mm)	€	UE / MOQ
8474	300	10,42	1-12-24-0-0 / 12

Rodillo de recambio

Wheel (spare part)
Rouleau (pièce de rechange)
Rullo
Austauschrad

REF.	€	UE / MOQ
8566	20,42	1-0-200-0-0 / 1

Cuchilla de recambio

Knife (spare part)
Couteau (pièce de rechange)
Lame
Austauschklinge

REF.	€	UE / MOQ
8565	7,66	1-0-200-0-0 / 1



Espatula plancha rectangular biselada mango madera

Spatula. Wood handle
Palette. Manche en bois
Spatola hamburger
Bratenwender holzgriff



REF.	MODELO	W (mm)	L (mm)	€	UE / MOQ
8942	RECTANGULAR	80	290	4,31	1-12-48-0-0 / 12
8943	TRIANGULAR	80	235	3,56	1-12-48-0-0 / 12



Recambio 10 cuchillas

Blister 10 blades
Blister 10 lames
Blister 10 lame
Blister 10 messer

REF.	€	UE / MOQ
8507	3,99	1-50-100-0-0 / 10



Abrelatas industrial

Can opener
Ouvre-boîtes professionnel
Apriscatole
Industrieller edelstahl dosenöffner

REF.	H (mm)	€	UE / MOQ
8564	640	150,58	1-0-8-0-0 / 1



Espátula recta emplatado
 Straight spatula
 Mini spatule
 Spatola
 Minispachtel



REF.	L Total (mm)	Paleta (mm)	€	UE / MOQ
8475	210	110	4,39	1-48-288-0-0 / 12



Espátula ancha emplatado
 Spreader
 Mini spatule
 Spatola
 Minispachtel



REF.	L Total (mm)	Paleta (mm)	€	UE / MOQ
8477	180	70	4,39	1-48-288-0-0 / 12



Aro redondo
 Round ring
 Moulage rond
 Teglia tondo
 Ringe rund

REF.	Ø (mm)	H (mm)	€	UE / MOQ
7461	60	45	1,42	1-32-128-512-1536 / 12
7462	70	45	1,42	1-32-128-768-1536 / 12
7463	80	45	1,67	1-32-128-768-1536 / 12
7464	90	45	1,80	1-32-128-768-1536 / 12
7465	100	45	1,93	1-32-128-256-512 / 12
7466	120	45	2,06	1-32-128-256-512 / 12

REF.	SET	€	UE / MOQ
7449	PACK 6	10,84	1-24-48-192-392 / 6



Espátula angular emplatado
 Angular spatula
 Mini spatule
 Spatola
 Minispachtel



REF.	L Total (mm)	Paleta (mm)	€	UE / MOQ
8476	220	95	4,39	1-48-288-0-0 / 12



Tenedor emplatado
 Fork
 Fourchette
 Forchetta
 Spiess



REF.	L Total (mm)	Paleta (mm)	€	UE / MOQ
8478	190	80	4,39	1-48-288-0-0 / 12



Aro cuadrado
 Square ring
 Moulage carre
 Teglia quadrato
 Ringe quadratisch

REF.	W/L (mm)	H (mm)	€	UE / MOQ
7467	60	45	1,61	1-32-128-512-1536 / 12
7468	70	45	1,80	1-32-128-768-1536 / 12
7469	80	45	2,06	1-32-128-768-1536 / 12
7470	90	45	2,32	1-32-128-768-1536 / 12
7471	100	45	2,58	1-32-128-768-1536 / 12
7472	120	45	2,45	1-32-128-768-1536 / 12

REF.	SET	€	UE / MOQ
7450	PACK 6	13,13	1-24-48-192-392 / 6

Ideal para remover salsas, rebañar o emplatado. Su tamaño reducido permite al chef llevarla siempre encima para tenerla siempre a mano.

Ideal for stirring sauces, basting or plating. Its small size allows the chef to carry it with him or her at all times so that it is always at hand.



Mini lengua de silicona
 Silicone spoon
 Cuillère silicone
 Spatola silicone
 Silikonlöffel



REF.	L (mm)	COLOR	€	UE / MOQ
5163	170	ROSA	3,86	1-24-96-1920-5760 / 24
5162	170	VERDE	3,86	1-24-96-1920-5760 / 24
5161	170	ROJA	3,86	1-24-96-1920-5760 / 24



Pinza chef recta
 Straight chef tong
 Pince chef droite
 Pinze chef diritta
 Konventionelle küchenmeister zange

REF.	L (mm)	€	UE / MOQ
7477	210	6,47	1-24-96-1920-5760 / 6
7478	300	9,42	1-24-96-1920-5760 / 6



Pinza chef precisión
 Precision chef tong
 Pince chef précision
 Pinze chef precisione
 Präzisions-küchenmeister zange

REF.	L (mm)	€	UE / MOQ
7475	160	5,75	1-24-96-1920-5760 / 6
7476	240	7,52	1-24-96-1920-5760 / 6



Pinza chef curva
 Curved chef tong
 Pince chef courbée
 Pinze chef curve
 Chefkoch zange gebogen

REF.	L (mm)	COLOR	€	UE / MOQ
7473	145	INOX	5,46	1-24-96-1920-5760 / 6
7474	200	INOX	6,90	1-24-96-1920-5760 / 6
8680	200	ORO	7,21	1-24-96-1920-5760 / 6
8681	200	COBRE	7,21	1-24-96-1920-5760 / 6
8682	200	NEGRO	7,21	1-24-96-1920-5760 / 6



* Punta estriada para un mejor agarre de los alimentos.

Grooved tip for a better grip of the foods.



Acabado brillo: más higiénico.
Menos poroso, facilita la limpieza.

Mirror finish: more hygienic.
Less porous, easier to clean.

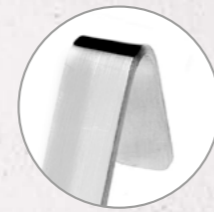

Mango con gancho para un fácil almacenamiento.

Hook handle for easy storage



Capacidad grabada en el mango.

Capacity engraved on the handle

Mango más grueso con nervio central que le proporciona más rigidez y resistencia.

Thicker handle with a central rib for more rigidity and stiffens and strengthens the handle.



Monoblock / Monoblock

Espumadera con malla

Mesh skimmer
Écumoire maillée
Schiumarola a rete passabrodo
Drahtschaumlöffel



REF.	Ø(mm)	€	UE / MOQ
9735	140	13,38	1-0-50-0-0 / 10
9736	160	15,00	1-0-30-0-0 / 10
9737	180	17,00	1-0-30-0-0 / 10
9738	200	18,75	1-0-30-0-0 / 10
9739	240	21,11	1-0-30-0-0 / 10

Cazo Monoblock

One piece laddle
Louche monoblock
Mestolo monoblock
Löffel monoblock

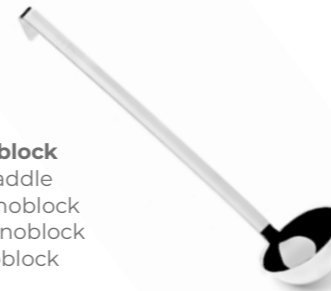

REF.	Ø(mm)	L(mm)	€	UE / MOQ
9712	65	300	8,63	1-10-60-0-0 / 10
9713	80	320	9,73	1-10-60-0-0 / 10
9714	90	330	11,25	1-10-40-0-0 / 10
9715	100	370	12,44	1-10-40-0-0 / 10
9716	120	430	13,50	1-10-40-0-0 / 10
9717	140	440	16,22	1-10-40-0-0 / 10
9718	160	470	18,93	1-10-20-0-0 / 10

Cuchara servir Monoblock

One piece spoon
Coulliere monoblock
Cucchiaio monoblock
Servierlöffel



REF.	L(mm)	€	UE / MOQ
9726	330	10,00	1-12-24-0-0 / 1

Tenedor 2 púas monoblock

One piece meat fork
Fourchette monoblock
Forchetta monoblock
Fleischgabel monoblock



REF.	L(mm)	€	UE / MOQ
9728	520	13,12	1-12-24-0-0 / 1

Utensilios / Juegos de cocina

Utensils / Kitchen tool

Araña

Tinned skimmer
Escumoire etamée
Schiumarola filo
Fritierschaufel



REF.	Ø(mm)	€	UE / MOQ
9729	140	9,35	1-12-24-0-0 / 1
9730	160	9,74	1-12-24-0-0 / 1
9731	180	10,47	1-12-24-0-0 / 1
9732	200	11,09	1-12-24-0-0 / 1
9733	220	12,16	1-12-24-0-0 / 1
9734	240	13,23	1-12-24-0-0 / 1

Espumadera Monoblock

One piece skimmer
Écumoire monoblock
Schiumarola monoblock
Schäumer monoblock



REF.	Ø(mm)	L(mm)	€	UE / MOQ
9719	80	290	6,75	1-10-60-0-0 / 10
9720	100	320	8,75	1-10-60-0-0 / 10
9721	120	350	11,46	1-10-40-0-0 / 10
9722	140	380	13,00	1-10-40-0-0 / 10
9723	160	410	15,50	1-10-40-0-0 / 10
9724	180	430	20,00	1-10-40-0-0 / 10
9725	200	450	23,75	1-10-40-0-0 / 10

Espátula perforada

Perforated spatula
Spatule perforée
Spatola forata
Schaufel gelocht



REF.	L(mm)	€	UE / MOQ
9727	350	11,50	1-12-24-0-0 / 1



Cazo
Ladle
Louche
Mestolo
Schöpflöffel

REF.	L _(mm)	€	UE / MOQ
8398	330	4,95	1-0-0-0-0 / 12



Espátula perforada
Slotted turner
Spatule perforée
Palafritto nylon
Schaufel gelocht

REF.	L _(mm)	€	UE / MOQ
8400	345	3,86	1-0-0-0-0 / 12



Forma antivuelco
No tipping

Pala lasaña
Nylon lasagna shovel
Palette à lasagne
Pala lasagna
Lasagneheber

REF.	L _(mm)	€	UE / MOQ
8402	290	3,91	1-0-0-0-0 / 12



Pala freir
Lasagna shovel
Palette à lasagne
Pala lasagna
Lasagneheber

REF.	L _(mm)	€	UE / MOQ
8404	290	4,39	1-0-0-0-0 / 12



Cuchara spaguetti
Spaghetti server
Cuillère a spaghetti
Servispaghetti nylon
Spaghettilöffel

REF.	L _(mm)	€	UE / MOQ
8405	325	4,35	1-0-0-0-0 / 12



Paleta pescado
Universal shovel
Pelle à poisson
Pala multiuso
Fischheber

REF.	L _(mm)	€	UE / MOQ
8401	335	4,00	1-0-0-0-0 / 12



Cuchara servir
Rice shovel
Cuillère de service
Cucchiaione riso
Servierlöffel

REF.	L _(mm)	€	UE / MOQ
8403	285	3,86	1-0-0-0-0 / 12



Pinza cocina
Kitchen pincers
Pince
Pinza cucina
Zange

REF.	L _(mm)	€	UE / MOQ
8407	310	4,04	1-0-0-0-0 / 12



Mango ergonómico.
Con relieves para mejorar el agarre.
Ergonomic handle.
Raised pattern for better grip.

BPA FREE
BPA FREE

Alta resistencia térmica.
Soportan temperatura de hasta 220°C
Strong heat-resistance.
For use in temperatures up to 220 °C

Nylon 6.6
Fibra de alta calidad.
Poca porosidad mayor dureza.
Nylon 6.6
High-quality fibres.
Non-porous, more hard-wearing.

Ligeras
Slight

No raya.
Suavidad con las superficies antiadherentes
Non-scratching.
Delicate on non-stick surfaces



Espátula crepes
Crepes spatula
Palette
Spatola crepes
Kuchenheber

REF.	L _(mm)	€	UE / MOQ
8406	335	3,99	1-0-0-0-0 / 12



Espumadera
Skimmer
Écumoire
Schiumarola
Schaumlöffel

REF.	L _(mm)	€	UE / MOQ
8399	335	4,35	1-0-0-0-0 / 12



PACKAGING BLISTER

NEW

Espátula madera
Solid turner
Spatule en bois
Spatola di legno
Holz-spatula

ACACIA WOOD



REF.	L(mm)	€	UE / MOQ
10717	330	4,00	1-12-72/12

NEW

Cuchara madera
Ponited spoon
Cuillère en bois
Cucchiaio di legno
Holzlöffel

ACACIA WOOD



REF.	L(mm)	€	UE / MOQ
10718	330	4,00	1-12-72/12



Soporte cubiertos 4 vasos
Cutlery holder stand 4 hole
Réceptient à couverts 4
Cestello porta posate
Besteckbehälter

REF.	W(mm)	L(mm)	H(mm)	€	UE / MOQ
9761	160	295	198	71,66	1-0-4-0-0/1

Vaso inox cubertería
Cutlery holder
Réceptient à couverts
Cestello porta posate
Besteckbehälter

REF.	Ø(mm)	H(mm)	€	UE / MOQ
9763	130	118	4,31	1-6-72-0-0/6

Biberón rojo
Red squeeze bottles
Distributeur
à pression rouge
Garrafa rosso
Rot dosierflasche



REF.	ml	H(mm)	€	UE / MOQ
8439	240	190	1,62	0-4-24-0-0 / 24
8440	360	220	1,73	0-4-24-0-0 / 24
8441	720	260	2,05	0-4-24-0-0 / 24

Biberón amarillo
Yellow squeeze bottles
Distributeur
à pression jaune
Garrafa giallo
Gelb dosierflasche



REF.	ml	H(mm)	€	UE / MOQ
8442	240	190	1,62	0-4-24-0-0 / 24
8443	360	220	1,73	0-4-24-0-0 / 24
8444	720	260	2,05	0-4-24-0-0 / 24



Barra de comandas
Order rack
Porte-fiches à billes
Asta portascontrini
Bons-/zettelhalte

REF.	W(mm)	L(mm)	H(mm)	€	UE / MOQ
9760	24	615	24	12,38	1-6-24-0-0/6

Pala recogeverduras
Dough scraper
Ramasse-légumes
Raschietto verdure
Gemüseschaufel



REF.	L(mm)	€	UE / MOQ
3029	140	4,64	1-0-24-288-1152/6



Triple boquilla:
ideal para decoraciones.
Triple nozzle:
great for decorations.

Biberón triple
Triple squeeze bottle
Triple distributeur
Garrafa com boquilha triplo
Dosierflasche mit dreifachdüse

REF.	ml	H(mm)	€	UE / MOQ
8449	360	180	2,04	0-4-24-0-0 / 24
8450	720	245	2,43	0-4-24-0-0 / 24



Todos los biberones
tienen marcas de medición
en milímetros.
All bottles
have measurement marks
in millimeters.

Biberón transparente
Clear squeeze bottles
Distributeur à pression transparent
Garrafa trasparente
Transparent dosierflasche

REF.	ml	H(mm)	€	UE / MOQ
8445	240	190	1,62	0-4-24-0-0 / 24
8446	360	220	1,73	0-4-24-0-0 / 24
8447	720	260	2,05	0-4-24-0-0 / 24
8448	1.000	310	3,53	0-4-24-0-0 / 24

NEW

Espolvoreador 3 posiciones
Stainless steel sprinkler 3p
Saupoudreuse acier 3p
Draga acciaio 3p
Bagger stahl



REF.	H(mm)	€	UE / MOQ
8794	110	5,99	1-1-100-600-1200 / 1

NEW

Salero profesional
Professional salt shaker
Salière prof.
Saliera prof.
Prof. Salzstreuer



REF.	H(mm)	€	UE / MOQ
8793	185	17,50	1-1-40-160-480 / 40

Pinza chef quitaespinas

Fish bone chef tong
Pince chef à désarêter
Pinze lisca del pesce chef
Frischgräten küchenmeister zange



REF.	L(mm)	€	UE / MOQ
7479	120	3,59	1-24-96-1920-5760 / 6

Pinza para rustidera

Lasagna pan tong
Pince plat à rôtir
Molla forno
Lasagnezangel



REF.	L(mm)	€	UE / MOQ
5656	185	7,16	1-10-100-600-1800 / 6



Colador chino con clip
Conical soup strainer with clip
Passoire chinoise
Cornetto cinese
Spitzsieb

REF.	Ø(mm)	€	UE / MOQ
9764	160	5,68	1-0-60-0-0 / 10
9765	180	6,77	1-0-60-0-0 / 10
9766	200	8,28	1-0-60-0-0 / 10
9767	220	9,43	1-0-60-0-0 / 10
9768	240	10,42	1-0-30-0-0 / 10
9769	260	11,56	1-0-30-0-0 / 10



Colador inox
Oil strainer
Passoire à huile
Colino per l'olio
Ölsieb

REF.	Ø(mm)	€	UE / MOQ
2884	80	2,54	1-0-24-960-1920 / 6
2885	100	2,84	1-0-24-960-1920 / 6
2886	120	3,84	1-0-24-960-1920 / 6
2887	140	4,30	1-0-24-960-1920 / 6
2888	160	4,47	1-0-24-960-1920 / 6
2889	180	5,55	1-0-24-960-1920 / 6
2890	200	6,15	1-0-24-960-1920 / 6
2891	220	6,94	1-0-24-960-1920 / 6

Rustidera

Lasagna pan
Plat à rôtir
Rostiera
Lasagneform

REF.	W(mm)	L(mm)	H(mm)	€	UE / MOQ
1422	250	180	40	9,74	1-0-24-120-240 / 4
1421	300	220	50	13,23	1-0-12-108-216 / 4
1420	350	260	50	17,60	1-0-12-60-120 / 4
1419	400	300	60	21,39	1-0-12-60-120 / 4
5282	450	320	65	49,05	1-0-4-16-48 / 4
5283	500	360	70	60,25	1-0-4-16-48 / 4
5284	600	400	75	77,13	1-0-4-20-20 / 4



NEW

Tapa inox multiusos
Lid
Couvercle
Coperchio
Deckel



REF.	Ø(mm)	€	UE / MOQ
8788	210	3,57	1-20-40-0-0 / 20
8789	250	4,77	1-20-40-0-0 / 20
8790	290	6,26	1-20-40-0-0 / 20
8791	320	7,40	1-20-40-0-0 / 20

NEW

Cazoleta inox
Stainless steel serving pot
Casserole de service acier
Casseruola per servire acciaio
Servierpfanne aus stahl



REF.	Ø(mm)	€	UE / MOQ
8792	150	7,35	1-5-40-100-800 / 40

Escurre fritos y carnes

Fry colander
Passoire à frites
Cesta per friggere
Frittensieb

REF.	W(mm)	L(mm)	€	UE / MOQ
8381	290	400	149,35	1-0-6-24-24 / 1
8382	390	500	184,13	1-0-4-12-24 / 1
8383	390	600	209,62	1-0-3-9-27 / 1



Harinero

Flour bin
Tamis à farine inox
Farinheiro
Mehlsieb

REF.	W _(mm)	L _(mm)	H _(mm)	€	UE / MOQ
8384	265	370	180	126,15	1-0-1-8-24 / 1
8385	265	500	180	143,81	1-0-1-6-18 / 1
8386	330	500	180	146,80	1-0-1-4-12 / 1

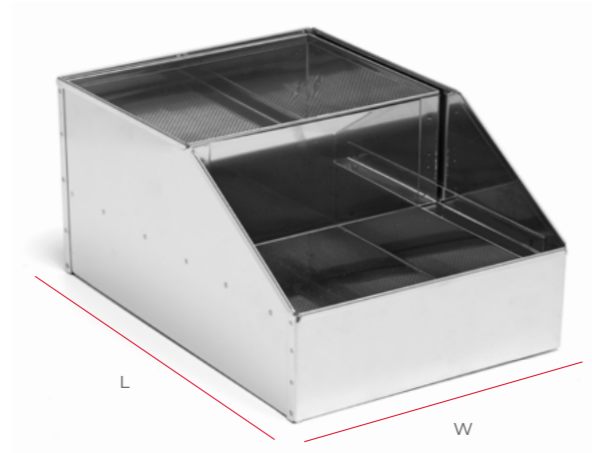

Cedazo 4 mallas intercambiables

Sieve - inter changeable
Tamis 4 maille
Setaccio 4 rete
Siebe 4 maschen

REF.	Ø _(mm)	€	UE / MOQ
9770	220	19,58	1-0-48-0-0 / 6
9771	260	23,18	1-0-48-0-0 / 6



NEW

Cedazo Velo

Sieve velo
Tamis velo
Setaccio velo
Siebe velo

REF.	Ø _(mm)	€	UE / MOQ
10650	250	13,18	1-6-12-0-0 / 1
10651	300	16,51	1-6-12-0-0 / 1
10652	350	20,83	1-4-8-0-0 / 1



NEW

Cedazo Harina

Sieve flour
Tamis farine
Setaccio farina
Siebe muscheln

REF.	Ø _(mm)	€	UE / MOQ
10653	250	13,18	1-6-12-0-0 / 1
10654	300	16,51	1-6-12-0-0 / 1
10655	350	20,83	1-4-8-0-0 / 1



NEW

Cedazo Pan

Sieve bread
Tamis pain
Setaccio pane
Siebe brot

REF.	Ø _(mm)	€	UE / MOQ
10656	300	16,51	1-6-12-0-0 / 1
10657	350	20,83	1-4-8-0-0 / 1



NEW

Cedazo Pescado

Sieve fish
Tamis poisson
Setaccio peixe
Siebe fish

REF.	Ø _(mm)	€	UE / MOQ
10658	300	16,51	1-6-12-0-0 / 1
10659	350	20,83	1-4-8-0-0 / 1





Barillas de acero inoxidable de alta resistencia.

Tough stainless steel bars.



Mango de nylon de forma ergonómica. Con relieves para mejorar el agarre.

Ergonomic nylon handle. Raised pattern for better grip.

Fácil almacenaje.

Easy to store.



Batidor 8 varillas Nylon

Whisk 8 wires
Fouet 8 fils
Frusta 8 fili
Rührbesen 8 drähte

REF.	L (mm)	€	UE / MOQ
8480	250	7,90	1-12-48-0-0 / 12
8481	300	9,01	1-12-48-0-0 / 12
8482	350	10,67	1-12-48-0-0 / 12
8483	400	11,37	1-6-24-0-0 / 6

Batidor 8 varillas

Whisk 8 wires
Fouet 8 fils
Frusta 8 fili
Rührbesen 8 drähte

REF.	L (mm)	€	UE / MOQ
9740	250	8,34	1-0-40-0-0 / 10
9741	300	8,45	1-0-30-0-0 / 10
9742	350	8,86	1-0-30-0-0 / 10
9743	400	9,73	1-0-30-0-0 / 10
9744	450	10,18	1-0-30-0-0 / 10
9745	500	10,63	1-0-30-0-0 / 10



Cuchara silicona

Silicon spoon
Cuillère silicone
Cucchiaio silicone
Silikonlöffel



REF.	L (mm)	€	UE / MOQ
8484	250	4,18	1-12-72-0-0 / 12
8485	350	5,10	1-12-72-0-0 / 12
8486	400	5,82	1-12-72-0-0 / 12



Espátula silicona

Silicon spatula
Spatule silicone
Spatola silicone
Silikonspachtel



REF.	L (mm)	€	UE / MOQ
8487	250	4,18	1-12-72-0-0 / 12
8488	350	5,10	1-12-72-0-0 / 12
8489	400	5,82	1-12-72-0-0 / 12



Jarra medidora

Measuring PP jug
Pichet gradué PP
Caraffa graduata
Messbecher



REF.	ml	H (mm)	€	UE / MOQ
8451	500	133	2,17	1-12-60-0-0 / 12
8452	1.000	160	2,65	1-6-60-0-0 / 6
8453	2.000	215	3,80	1-6-60-0-0 / 6



Espátula pastelera

Small baker spatula
Palette
Spatola cuoco
Kuchenspachtel

REF.	SIZE	HOJA (mm)	€	UE / MOQ
8932	s	135	2,16	1-12-48-0-0 / 12
8933	M	225	2,44	1-12-48-0-0 / 12
8934	L	300	3,05	1-12-48-0-0 / 12

Bol semiesférico

Mixing bowl
Bassine hémisphérique
Bastardella semisferica
Schneeslagkessel



REF.	Ø (mm)	€	UE / MOQ
9748	160	2,14	1-0-100-0-0 / 10
9749	220	3,96	1-0-50-0-0 / 10
9750	240	4,74	1-0-50-0-0 / 10
9751	300	7,92	1-0-50-0-0 / 10
9752	340	10,05	1-0-25-0-0 / 5
9753	360	10,77	1-0-25-0-0 / 5
9754	400	14,74	1-0-25-0-0 / 5

Flanera

Pudding mould
Moule à flan
Crème caramel
Becherförmchen



REF.	Ø (mm)	H (mm)	€	UE / MOQ
9746	75	45	2,58	1-0-48-0-0 / 48
9747	85	85	3,86	1-0-48-0-0 / 48

Flanera profesional

Pudding mould
Moule à flan
Crème caramel
Becherförmchen



REF.	Ø (mm)	H (mm)	€	UE / MOQ
9632	75	5	2,58	1-12-120-960-3840 / 12
9633	85	55	3,86	1-12-120-960-3840 / 12

NEW



Molde PC semiesfera 30mm
Semisphere polycarbonate mould
Moule PC demi-sphère
Stampo semisfera
Halbkugelförmige PC-Form

REF.	size(mm)	€
10356	275x175	24,03



Molde PC bombón corazón diamante
Heart diamond praline chocolate mould
Moule PC à chocolat cœur diamant
Stampo PC bonbon a cuore di diamante
Diamant-Herz-Pralinenform aus PC

REF.	size(mm)	€
10358	275x175	24,03



Molde PC bombón cacao
Pralina cocoa stampo polycarbonate mould
Moule PC à chocolat cacao
Stampo PC bonbon al cacao
Kakaobonbonform aus PC

REF.	size(mm)	€
10357	275x175	24,03



Molde PC bombón círculo
Circle chocolate PC mould
Moule PC à chocolat rond
Stampo PC bonbon cerchio
Pralinenkreisform aus PC

REF.	size(mm)	€
10362	275x175	24,03



Molde PC bombón cuadrado
Chocolate square PC mould
Moule PC à chocolat carré
Stampo bonbon quadrato
Quadratische Pralinenform aus PC

REF.	size(mm)	€
10363	275x175	24,03



Molde PC bombón corazón
Chocolate heart PC mould
Moule PC à chocolat cœur
Stampo PC bonbon cuore
Herz-Pralinenform aus PC

REF.	size(mm)	€
10359	275x175	24,03



Molde PC bombón piramide
Chocolate pyramid PC mould
Moule PC à chocolat pyramide
Stampo PC bonbon a piramide
Pyramiden-Pralinenform aus PC

REF.	size(mm)	€
10360	275x175	24,03



Molde PC bombón redondo
Chocolate round PC mould
Moule PC à chocolat rond
Stampo PC bonbon rotondo
Runde Pralinenform aus PC

REF.	size(mm)	€
10361	275x175	24,03



Molde PC bombón cuadrado
Chocolate square PC mould
Moule PC à chocolat carré
Stampo PC bonbon quadrato
Quadratische Pralinenform aus PC

REF.	size(mm)	€
10365	275x175	24,03



Molde PC bombón redondo twist
Chocolate twist PC mould
Moule PC à chocolat rond twist
Stampo bonbon rotondo twist
Runde Pralinenform aus PC twist

REF.	size(mm)	€
10364	275x175	24,03



Fuente de chocolate evolución 5 niveles
Chocolate fountain evolution 5 levels
Fontaine à chocolat 5 niveaux
Fontana di cioccolato evolution 5 nivelli
Schokoladenbrunnen - Entwicklung in 5 Stufen

REF.	Ø(mm)	H(mm)	€
10366	380	800	1379,17



MELTINCHOC PRO DIGITAL 6L

REF.	size(mm)	H(mm)	€
10369	330x400	135	1066,39



MELTINCHOC PRO DIGITAL 1,8L

REF.	size(mm)	H(mm)	€
10370	260x260	160	313,64





Horno / Moldes Silicona
Bakery / Silicon Moulds

Artículos en color naranja hasta fin de stock. Sigüentes entregas en color negro.

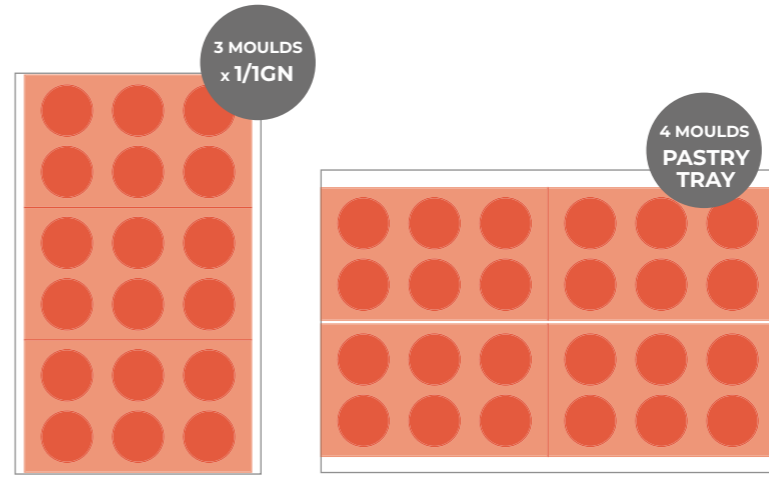

Molde silicona
Silicone mould
Moule silicone
Stampo in silicone
Muffin-Kugelform



ART.	REF.	size(mm)	piece(mm)	€	
A	Muffin 6 figuras	10389	175x300	68	15,45
B	Media esfera 5 figuras	10386	175x300	80	15,45
C	Media esfera 6 figuras	10387	175x300	70	15,45
D	Media esfera 6 figuras	10388	175x300	60	15,45
E	Pastel 12 figuras	10390	175x300	79x29	15,45

Molde silicona éclair 28 figuras
Silicone mould éclair 28 pcs
Moule silicone éclair 28 figures
Stampo in silicone éclair 28 figure
Silikonform Eclair 28 Figuren



REF.	size(mm)	piece(mm)	€
10393	595x395	130x30	72,10



Molde silicona love 24 figuras
Silicone mould love 24 pcs
Moule silicone love 24 figures
Stampo in silicone love 24 figure
Silikonform Love 24 Figuren

REF.	size(mm)	piece(mm)	€
10392	595x395	75x68	72,10



Molde silicona media esfera 24 figuras
Silicone mould half sphere 24 pcs
Moule silicone demi-sphère 24 figures
Stampo in silicone a mezza sfera 24 figure
Silikonform Halbkugel 24 Figuren

REF.	size(mm)	piece(mm)	€
10391	595x395	40	72,10



Manga pastelera desechable 100 piezas

Roll pipingbags 100 pieces
Poche à douille jetable 100 pièces
Sacca da pasticceria usa e getta 100 pezzi
Einweg-Spritzbeutel 100 Stück

REF.	size(mm)	€
10373	400	20,60
10371	550	27,47
10372	650	34,33



Apto para cualquier tipo de alimento.

Suitable for any type of food.

No deja olores ni sabores en tus elaboraciones.

It leaves no odours or flavours in your preparations.

Muy fina y manejable, se puede retorcer, estirar y presionar sin deformarse.

Very thin and manageable, it can be twisted, stretched and pressed without deformation.

Manga pastelera superflexible

Pastry bag superflex
Poche à douille super flexible
Sacca da pasticceria super flessibile
Superflexibler Spritzbeutel

REF.	size(mm)	€
10375	340	9,61
10376	450	12,70
10374	500	18,03

Multi Ice Revolution. Moldes de plástico especial con una capa externa adicional de resina naranja que hace que las dos carcasas sean más elásticas y resistentes a la expansión del hielo.

La capa de silicona en el interior de la carcasa y los tornillos de fijación no dejan salir el agua y aseguran que el molde pueda ser reutilizado muchas veces.

Multi Ice Revolution. Moulds made of special plastic with an additional external orange resin layer which makes the two shells more elastic and more resistant against ice expansion.

The silicone packing inside the shell and the fixing screws do not let the water come out and assure that the mould can be reused many times.



Molde hielo cisne

Ice mould swan
Moule glaçon cygne
Stampo del ghiaccio cigno
Schwanen-Eisform

REF.	size(mm)	H(mm)	€
10368	600x250	650	583,67



Molde hielo pareja

Ice mould married couple
Moule glaçon couple
Stampo del ghiaccio sposi
Paar-Eisform

REF.	size(mm)	H(mm)	€
10367	510x410	960	583,67



Vaso transparente eclair 120ml
Transparent glass eclair 120ml
Verrine transparente
Vetro trasparente eclair 120ml
Transparente Glas

REF.	size(mm)	H(mm)	PACK	€
10383	137x37	41	100	31,93



Tapa transparente eclair 120ml
Transparent lid eclair 120ml
Couvercle transparent 120ml
Coperchio trasparente eclair 120ml
Transparente Abdeckung 120ml

REF.	size(mm)	H(mm)	PACK	€
10384	137x37	6	100	19,74



Vaso transparente classic 65ml
Transparent glass classic 65ml
Verrine transparente classic 65ml
Vetro trasparente classic 65ml
Transparente Abdeckung classic 65ml

REF.	size(mm)	H(mm)	PACK	€
10377	42	65	100	23,00



Vaso transparente cup 135ml
Transparent glass cup 135ml
Verrine transparente 135ml
Vetro trasparente cup 135ml
Transparente Glas 135ml

REF.	size(mm)	H(mm)	PACK	€
10382	70	67	100	40,51



Tapa transparente
Transparent lids
Couvercle transparent
Coperchio trasparente
Transparente Abdeckung

REF.	Ø(mm)	PACK	€
10379	78	100	22,66



Vaso transparente bucket 210ml
Transparent glass bucket 210ml
Verrine transparente bucket 210ml
Vetro trasparente bucket 210ml
Transparente Glas 210ml

REF.	size(mm)	H(mm)	PACK	€
10378	78	57	100	37,42



Vaso transparente cuadrado
Transparent glass square
Verrine transparente carrée
Vetro trasparente quadrato
Quadratisches transparentes Glas

REF.	size(mm)	H(mm)	PACK	€
10380	50x50 - 120ML	70	100	28,50
10381	57x57 - 175ML	73	100	34,68



Vaso transparente triangulo 175ml
Transparent glass triangle 175ml
Verrine transparente triangulaire 175ml
Vetro trasparente triangolo 175ml
Dreieckiges transparentes Glas 175ml

REF.	size(mm)	H(mm)	PACK	€
10385	81x83	65	100	33,99



Sartén pancake con mango BK

Pancake frypan with BK handle
Poêle pancake avec manche BK
Padella pancake manico BK
Pfanne pancake mit BK-griff

MOQ 1 UNIDAD



REF.	Ø(mm/inches)	ml	e(mm)	H(mm)	€	EAN
10060	250/9,8"	-	65	25	63,88	8001586004705



Sartén creps con mango BK

Crepe frying pan with BK handle
Crêpe poêle avec manche BK
Crepe padella manico BK
Pfanne Krepp mit BK-griff

MOQ 1 UNIDAD



REF.	Ø(mm/inches)	ml	e(mm)	H(mm)	€	EAN
10061	280/11"	-	65	23	80,48	8001586003340

MOLDE PARA HORNEAR REPOSTERÍA CREATIVA
BAKING MOLD FOR CREATIVE CAKES

Producidos íntegramente en Italia, su diseño hace que los moldes para tartas Risolí sean la opción correcta para todos tus postres.

Produced entirely made in Italy, their design makes Risoli cake tins the ideal choice for all your baking.



EXCELENTE ANTIADHERENTE
EXCELLENT NON-STICK

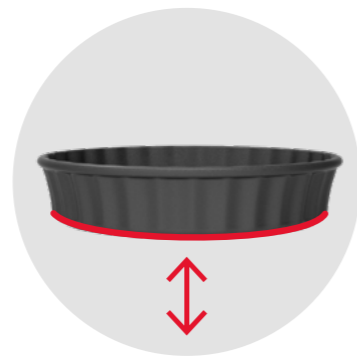

GRAN ESPESOR, ROBUSTO
EXTRA THICK, EXTREME HARD

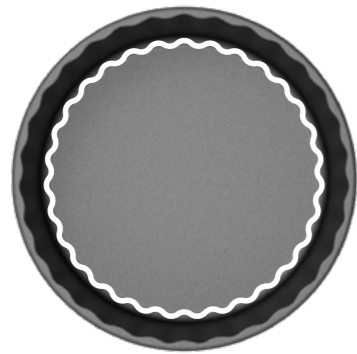

PARA TARTAS CREATIVAS
FOR CREATIVE CAKES

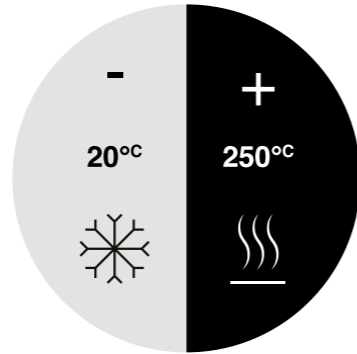

PERFECTO DE -20° A 250°
PERFECT FROM -20° TO 250°C

Los fondos extragrosos y los revestimientos antiadherentes de los moldes garantizan no solo el horneado, gracias a su correcta conducción del calor, sino también asegura que mantengan mejor su forma que otros moldes similares, haciéndolos perfectos también para servir en la mesa.

Extra thick bottoms and non-stick coatings guarantee not just even baking thanks to correct heat conduction, but also ensure the tins keep their shape better than others on the market, making them perfect also for serving at the table.



ROYAL D'ALÙ. DESDE 1965.

Diseño: Mínima 2020
Design: Minimal 2020

Material: Aluminio fundido - hecho a mano
Material: Cast Aluminium - Handmade

Capa: Verde, Granito, Perfil
Coating: Green, Granito, Profile

Garantía: 2 años
Warranty: 2 years

Black Plus®
ELDIAMANT®
PROFILE



Tarta de plato hondo "crostata" 4/6 personas
Deep dish tart "crostata" 4/6 people
Tarte creuse "crostata" 4/6 personnes
Crostata 4/6 persone
Deep dish torte "crostata" 4/6 personen

MOQ 1 UNIDAD

REF.	Ø (mm)	ml	€	EAN
10062	240	200	44,27	8001586013462



Black Plus®
ELDIAMANT®
PROFILE



Tarta de plato hondo "donut" 6/8 personas
Deep dish tart "donut" 6/8 people
Tartelette "beignet" 6/8 personnes
Ciambellone con foro 6/8 persone
"Donut"-torte 6/8 personen

MOQ 1 UNIDAD

REF.	Ø (mm)	ml	€	EAN
10063	260	200	53,75	8001586013586





Cocción / Sartenes profesionales
Cooking / Professionals fry pans

COLECCIÓN / COLLECTION

/ ETNA / TEIDE / VULCANO / AUVERNIA / USSON / VESUVIO / FUJI

comas



	SARTÉN FRY PAN	ALUMINIO ALUMINIUM	ALUMINIO ALUMINIUM	ALUMINIO ALUMINIUM	ALUMINIO ALUMINIUM	ALUMINIO ALUMINIUM	INOX	INOX
	MANGO HANDLE	INOX	INOX	INOX	HIERRO IRON	HIERRO IRON	INOX	INOX
	ANTIADHERENTE NON-STICK							
	VITRO	●	●	●	●	●	●	●
	ELÉCTRICO ELECTRIC	●	●	●	●	●	●	●
	GAS	●	●	●	●	●	●	●
	INDUCCIÓN INDUCTION		●			●	●	●
	HORNO OVEN	●	●	●				
	APTO CONTACTO ALIMENTARIO FOODCONTACT SAFE							

RISOLI
IL PRESSOFUSO IN CUCINA

/ FUSA / CLASSICA / ERGO



	SARTÉN FRY PAN	ALUMINIO FUNDIDO CAST ALUMINIUM	ALUMINIO FUNDIDO CAST ALUMINIUM	ALUMINIO FUNDIDO CAST ALUMINIUM
	MANGO HANDLE	INOX	INOX	
	ANTIADHERENTE NON-STICK			
	VITRO	●	●	
	ELÉCTRICO ELECTRIC	●	●	
	GAS	●	●	
	INDUCCIÓN INDUCTION			●
	LAVAVAJILLAS DISWASHER	●		
	APTO CONTACTO ALIMENTARIO FOODCONTACT SAFE			



Capa intermedia parcialmente reforzada.

Partially reinforced mid-layer.

Imprimación reforzada: Base de partículas de Titanio.

Reinforced printing: Base of Titanium particles.



Acabado de alta liberación.

Highly nonstick finish.

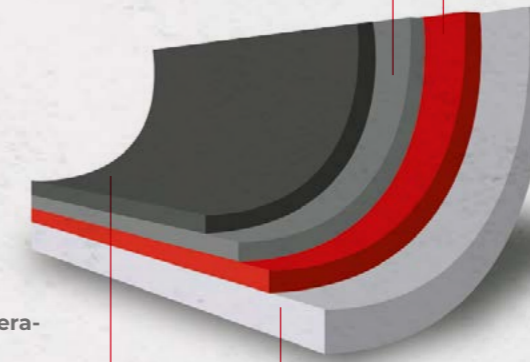

Aluminio de 4 mm de espesor.

4 mm thick aluminium.



QuanTanium is a trademark of PPG Industries Ohio, Inc., used with permission. © 2020 PPG Industries, Inc. All rights reserved.

Primer y único antiadherente con una mezcla única de partículas de titanio.

La multi-capa reforzada de titanio es un antiadherente más resistente conocido hasta hoy.

El sistema utilizado para la fabricación del QuanTanium® ha sido diseñado para obtener la máxima sinergia con el titanio obteniendo así la máxima resistencia.

The first and only non-stick coating with a unique blend of titanium particles.

The titanium reinforced multi-layer is the strongest non-stick coating known to date.

The system used to manufacture QuanTanium® has been designed for maximum synergy with the titanium for maximum strength.

Sartenes diseñadas para resistir los servicios más exigentes.

Mango hermético.

Sealed handle.

Mango fabricado en acero inoxidable de forma tubular para facilitar la sujeción de la sartén.

Tubular stainless steel handle for easy handling.

Remachado al cuerpo de la sartén para proporcionar una sujeción superior y una máxima seguridad en el momento de su uso.

Riveted to the pan for strength and safety in use.

Eficiencia de la distribución calórica: Su cuerpo de aluminio de alta calidad capta y distribuye de la mejor manera el calor por toda la superficie.

Efficient conduction of heat: The high-quality aluminium body captures and conducts heat across the whole surface.

Triple capa antiadherente de alto rendimiento.

High-performance reinforced non-stick coating.

Recubrimiento totalmente libre de PFOA.

Coating totally PFOA-free.

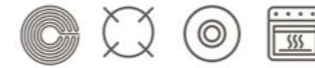

4mm de grosor.
4mm thickness

ETNA

Sartén aluminio mango inox

Aluminium fry pan with inox handle
Poêle aluminium manche en inox
Padella in alluminio manico en inox
Aluminium-bratfanne griff inox

REF.	Ø(mm)	e(mm)	€	UE / MOQ
8342	180	2,5	18,00	1-0-6-54-324 / 12
8343	200	3,5	20,86	1-0-6-0-0 / 12
8344	220	3,5	24,95	1-0-6-0-0 / 12
8345	240	3,5	27,92	1-0-6-0-0 / 6
8346	260	4	30,13	1-0-6-0-0 / 6
8347	280	4	31,21	1-0-6-0-0 / 6
8348	320	4	43,25	1-0-6-0-0 / 6
8349	360	4	43,78	1-0-6-0-0 / 6
8350	400	4	52,00	1-0-6-0-0 / 6



Fondo de inducción. Difusión rápida y uniforme del calor.
Induction base. Rapid, uniform distribution of heat.

TEIDE

Sartén aluminio mango inox / Inducción

Aluminium induction fry pan with inox handle
Poêle induction aluminium manche en inox
Padella induzione in alluminio manico en inox
Induktion aluminium-bratfanne griff inox

REF.	Ø(mm)	e(mm)	€	UE / MOQ
8954	200	3	19,96	1-0-6-0-0 / 6
8955	240	3	25,36	1-0-6-0-0 / 6
8956	280	3	30,26	1-0-6-0-0 / 6
8957	320	3	37,34	1-0-6-0-0 / 6

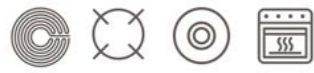

Sartén saltapasta. La altura de la pared y la curvatura del ángulo de la base, hacen de ésta una sartén ideal para salteados de pasta, arroces y verduras.

Efficient conduction of heat: The high-quality aluminium body captures and conducts heat across the whole surface.



VULCANO

Sartén aluminio antiadherente alta mango inox
Deep frypan, non stick coating
Poêle avec revêtement anti-adhésif
Padella inox antiaderente
Bratpfanne mit antihafbeschichtung

REF.	Ø(mm)	e(mm)	H(mm)	€	UE / MOQ
9971	200	3	45	20,54	1-0-6-0-0/1
9972	240	3	50	26,21	1-0-6-0-0/1
9973	280	3	50	34,16	1-0-6-0-0/1
9974	320	3	50	40,41	1-0-6-0-0/1
9975	360	3	60	52,25	1-0-6-0-0/1
9976	400	3	70	60,98	1-0-6-0-0/1



Altura especial saltapasta.
Deep frying pan sauta pasta.

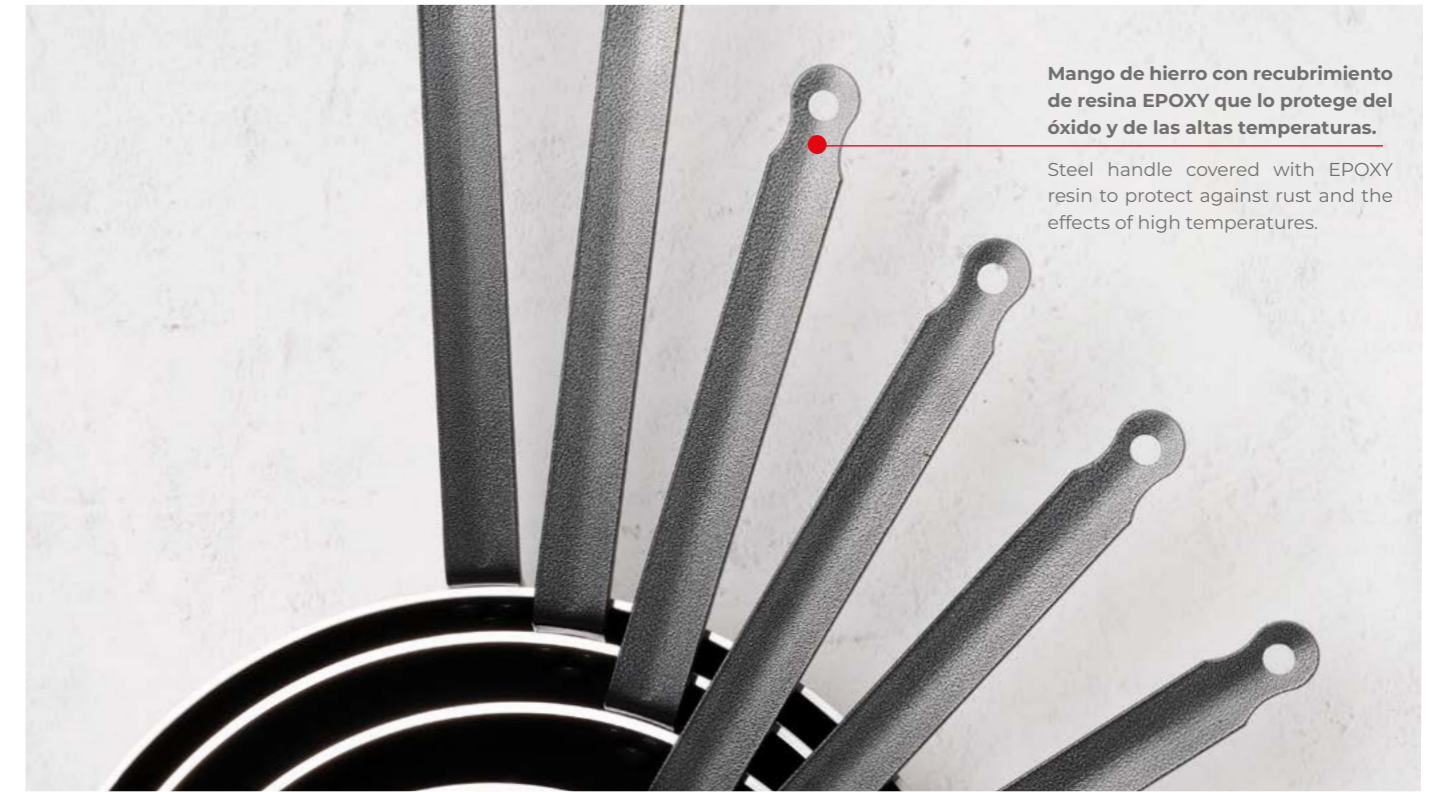

Mango de hierro con recubrimiento de resina EPOXY que lo protege del óxido y de las altas temperaturas.

Steel handle covered with EPOXY resin to protect against rust and the effects of high temperatures.



4mm de grosor.
4mm thickness..

AUVERNIA

Sartén aluminio mango hierro
Aluminium fry pan with iron handle
Poêle aluminium manche en fer
Padella in alluminio manico in ferro
Aluminium-bratfanne eisengriff

REF.	Ø(mm)	e(mm)	€	UE / MOQ
8351	180	2,5	14,30	1-0-6-0-0/12
8352	200	3,5	18,21	1-0-6-0-0/12
8353	220	3,5	19,25	1-0-6-0-0/12
8354	240	3,5	24,71	1-0-6-0-0/6
8355	260	4	27,57	1-0-6-0-0/6
8356	280	4	30,17	1-0-6-0-0/6
8357	320	4	36,41	1-0-6-0-0/6
8358	360	4	40,56	1-0-6-0-0/6
8359	400	4	59,23	1-0-6-0-0/6



Fondo de inducción. Difusión rápida y uniforme del calor.
Induction base. Rapid, uniform distribution of heat.

USSON

Sartén aluminio mango hierro / Inducción
Aluminium induction fry pan with inox handle
Poêle induction aluminium manche en inox
Padella induzione in alluminio manico in inox
Induktion aluminium-bratfanne griff inox

REF.	Ø(mm)	e(mm)	€	UE / MOQ
8958	200	3	22,75	1-0-6-0-0/6
8959	240	3	28,75	1-0-6-0-0/6
8960	280	3	33,73	1-0-6-0-0/6
8961	320	3	40,40	1-0-6-0-0/6

CAPA 1 Y CAPA 3
ACERO INOXIDABLE SUPERIOR

Una nueva gama de acero inoxidable que mezcla cromo, titanio y cobre.

LAYER 1 AND LAYER 3
SUPERIOR STAINLESS STEEL

A new stainless steel range mixing chrome, titanium and copper.

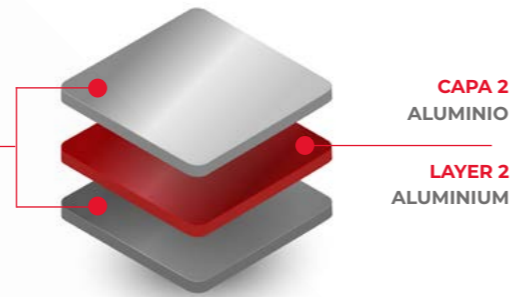

Alta resistencia a la corrosión y los ácidos alimentarios.

Highly resistant to rust and food acids.

Menos porosidad, más higiénico.

Less porous, more hygienic surface.

Óptima difusión del calor por toda la superficie.

Optimum heat distribution across the whole base.

Muy resistente a las altas temperaturas y al desgaste.

Hard-wearing and tolerant of high temperatures.

Apta para inducción
Suitable for induction.

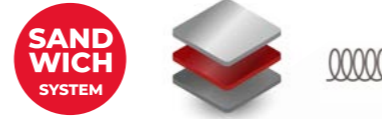

FUJI

Sartén inox mango inox

Frypan inox
Poêle à frire inox
Padella inox
Bratpfanne inox

REF.	Ø(mm)	e(mm)	€	UE / MOQ
8515	200	7	32,33	1-0-6-0-0/1
8516	240	7	38,16	1-0-6-0-0/1
8517	280	7	48,21	1-0-6-0-0/1
* 8518	320	10	63,13	1-0-4-0-0/1
* 8519	360	10	79,00	1-0-4-0-0/1
* 8520	400	10	94,50	1-0-4-0-0/1

VESUVIO

Sartén inox antiadherente mango inox

Frypan, non stick coating
Poêle avec revêtement anti-adhésif
Padella inox antiaderente
Bratpfanne mit antihaftbeschichtung

REF.	Ø(mm)	e(mm)	€	UE / MOQ
8509	200	7	42,75	1-0-6-0-0/1
8510	240	7	52,63	1-0-6-0-0/1
8511	280	7	65,00	1-0-6-0-0/1
* 8512	320	10	80,88	1-0-4-0-0/1
* 8513	360	10	106,10	1-0-4-0-0/1
* 8514	400	10	122,13	1-0-4-0-0/1



Después de usar lavar con esponja suave, secar y aplicar una capa de aceite de oliva para conservar el material.

After use, wash with a non-abrasive sponge, dry and apply a coat of olive oil to protect the material.

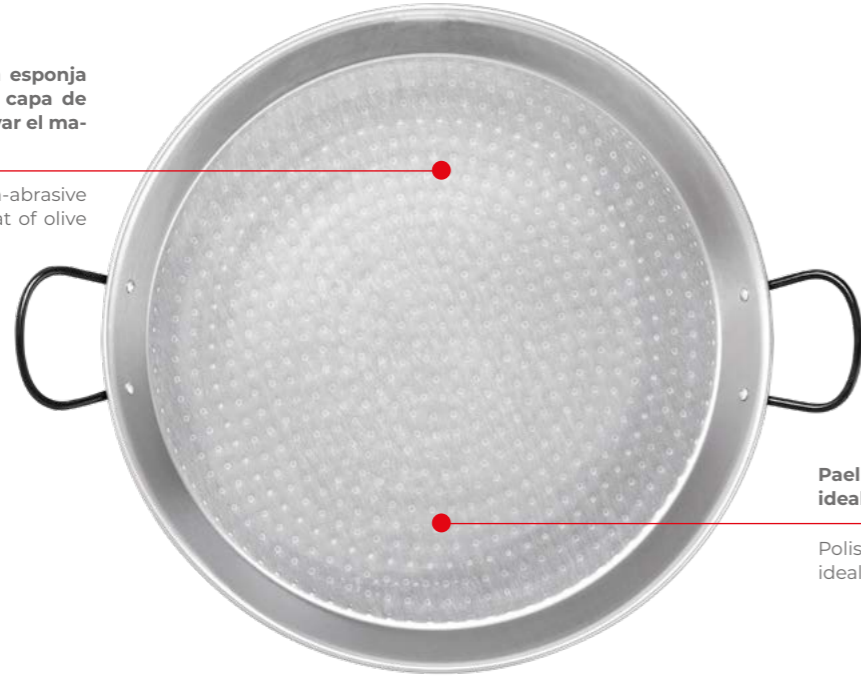

Paellera de acero pulido ideal para cocción de llama.

Polished steel paella pan, ideal for use over flame.



Paellera de acero con recubrimiento de esmalte que le proporciona una mayor resistencia al óxido.

Rust-resistant enamelled steel paella pan.

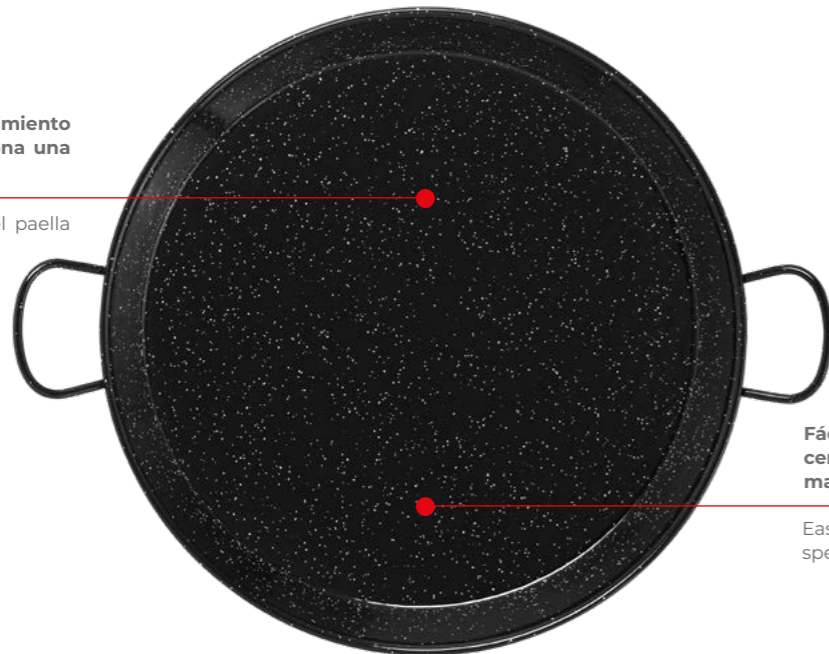

Fácil de limpiar y de almacenar, no precisan de un mantenimiento específico.

Easy to clean and store, no special care is required.



También para raciones individuales. Also for individual portions. **COLECCIÓN PELTRE (p.000)**



También para raciones individuales. Also for individual portions. **COLECCIÓN PELTRE (p.000)**

EL SALER

Paellera acero pulido

Polished steel spanish paella pan
Plat à paella toile acier
Padella valenciana lucida
Spanische paellapfanne aus poliertem stahl

REF.	Ø(mm)	Raciones	€	UE / MOQ
8964	300	4	9,50	1-0-0-0-0/1
8965	340	6	11,39	1-0-0-0-0/1
8966	380	8	14,20	1-0-0-0-0/1
8967	420	10	17,65	1-0-0-0-0/1
8968	460	12	20,76	1-0-0-0-0/1
8969	500	13	23,99	1-0-0-0-0/1
8970	600	20	39,75	1-0-0-0-0/1

RIBA ROJA

Paellera acero esmaltado

Enamelled steel paella pan
Plat à paella acier émaillé
Padella valenciana smaltata
Paellapfanne aus emailliertem stahl

REF.	Ø(mm)	Raciones	€	UE / MOQ
8971	300	4	13,66	1-0-0-0-0/1
8972	340	6	16,72	1-0-0-0-0/1
8973	380	8	20,67	1-0-0-0-0/1
8974	420	10	27,39	1-0-0-0-0/1
8975	460	12	32,02	1-0-0-0-0/1
8976	500	13	37,35	1-0-0-0-0/1
8977	600	20	60,25	1-0-0-0-0/1

ALBUFERA

Sartén honda acero esmaltado

Deep enamelled fry pan with handles.
Poele haute avec anses.
Padella smaltata con manici.
Tiefe paellapfanne aus emailliertem stahl mit griffen.

REF.	Ø(mm)	€	UE / MOQ
8978	280	13,11	1-0-0-0-0/1
8979	320	15,63	1-0-0-0-0/1
8980	360	20,00	1-0-0-0-0/1
8981	400	24,87	1-0-0-0-0/1
8982	450	35,50	1-0-0-0-0/1
8983	500	46,97	1-0-0-0-0/1



Quemador de cocción para uso doméstico y/o profesional. Fabricado en acero y recubierto de una capa de esmalte. Diseñado para ser utilizado en el exterior.

Burner for domestic or professional use. Made of enamelled steel. Designed for outdoor use.



Quemador paellero a gas
Enamelled gas burner
Brûleur émaillé
Bruciatore smaltato padella
Emaillierter gasbrenner

* Este producto está certificado según la normativa de gas vigente. Conexión roscada especial para Gas Natural.

También disponible bajo demanda para otras conexiones europeas.

This product has been certified under the law relating to gas appliances. Threaded Natural Gas connector.

Available on request to fit other European connectors.

REF.	Ø(mm)	€	UE / MOQ
8985	300	38,48	1-0-0-0-0 /1
8986	400	65,94	1-0-0-0-0 /1
8987	500	81,45T	1-0-0-0-0 /1



Tripode regulable para quemador
Base for burner
Pied pour bruleur
Trepiede padella
Dreifußständer für gasbrenner

REF.	W(mm)	H(mm)	€	UE / MOQ
8984	300	300	45,05	1-0-0-0-0 /1



Paravientos 3 piezas
Windshield
Pare-bris 3 pieces
Paravento 3 pezzi
Windschutzscheibe

REF.	W(mm)	H(mm)	€	UE / MOQ
8505	670	160	47,18	1-0-0-0-0 /1





La cuidadosa selección de nuestros materiales: Aluminio fundido a presión.
The careful selection of our materials: Die-cast aluminium.



Seleccionamos cuidadosamente las técnicas y los materiales más avanzados para crear nuestros productos. El uso exclusivo de aluminio fundido a presión (una materia prima certificada para uso alimentario) proporciona una distribución óptima y constante del calor, así como una gran resistencia a los diferentes métodos de cocción y un proceso de cocción más natural

We carefully select the most advanced techniques and materials to create our products. The exclusive use of die-cast aluminium (a raw material certified for food use) provides an optimal and constant heat distribution, as well as a high resistance to different cooking methods and a more natural cooking process.

Cocción homogénea.
Homogeneous cooking.

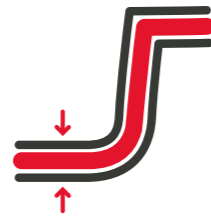

El aluminio fundido a presión tiene excelentes propiedades de conducción del calor y los alimentos se cocinan de manera uniforme sin que se quemen ni se altere su sabor, manteniendo las propiedades nutritivas en cada tipo de alimento.

The die-cast aluminium has excellent heat conduction properties and the food cooks evenly without burning or altering its taste, maintaining the nutritional properties in each type of food.

El aluminio está fundido a presión con un grosor considerable que distribuye el calor de manera uniforme y una base resistente a la deformación.

The aluminium is die-cast with a considerable thickness that distributes heat evenly and a base that is resistant to deformation.

No pierde calor, lo que permite ahorrar energía. Incluso cuando se apaga la fuente de calor, mantiene la temperatura durante otros 10/15 minutos manteniendo los alimentos calientes mientras se sirven en la mesa.

It doesn't lose heat, which saves energy. Even when the heat source is turned off, it maintains the temperature for another 10/15 minutes keeping the food warm while it's being served at the table.



La gama BLACKplus incluye en exclusiva el revestimiento ELDIAMANT PROFILE de última generación, capaz de garantizar una resistencia a las rayadas sin precedentes en los recubrimientos antiadherentes. El cuerpo en aluminio fundido de alto espesor para obtener ligereza, indeformabilidad y mejor distribución del calor, ELDIAMANT PROFILE con partículas minerales para cocinar sin aceite.



The BLACKplus range exclusively includes the latest generation ELDIAMANT PROFILE coating, capable of guaranteeing unprecedented scratch resistance in non-stick coatings. The high thickness cast aluminium body for lightness, non-deformability and better heat distribution, ELDIAMANT PROFILE with mineral particles for oil-free cooking.



40.000 ciclos de uso.



La garantía del producto es de (2+1 años) desde el momento de la compra (presentando el comprobante) y si se respetan las instrucciones de uso. Risolì no se hace responsables de daños causados por un incorrecto uso del producto.

The product is guaranteed (2+1 years) from the moment of purchase (presenting the receipt) and if the instructions for use are followed. Risolì is not responsible for any damage caused by incorrect use of the product.



Espesor 6 - 7 mm

6 - 7 mm thickness.

Mango de acero inoxidable 18/10 termoaislante con 4 remaches.

Stainless steel handle 18/10 heat protection with 4 rivets.

Revestimiento interior Teflon Profile antiadherente resistente al rayado.

Inside non stick coating TeFlon Platinum scratch resistant .

Garantía ECOCAST 3 años.

3 years ECOCAST guarantee.



Sartén fusa

1810/ 1810



INOX 18/10



Sartén fusa 1810
Frypan Fusa 1810
Poele fusa 1810
Padella fusa 1810
Pfanne fusa 1810

ALUMINIO FUNDIDO
CAST ALUMINIUM

REF.	Ø(mm / inches)	e(mm)	L(mm)	€	MOQ
10000	240/9,4"	6	50	73,51	1
10001	280/11"	6	52	87,24	1
10002	320/12,5"	6	58	96,72	1



INOX 18/10



Sartén honda fusa 1810
Deep frypan Fusa 1810
Poele profonde fusa 1810
Padella profonda fusa 1810
Tiefe pfanne fusa 1810

ALUMINIO FUNDIDO
CAST ALUMINIUM

REF.	Ø(mm / inches)	e(mm)	L(mm)	€	MOQ
10004	240/9,4"	6	70	79,84	1
10005	280/11"	6	70	93,56	1
10006	320/12,5"	6	80	104,84	1
10007	360/14"	6	80	125,83	1



FONDO: Alto espesor para una perfecta difusión del calor.

BOTTOM: High thickness for perfect heat diffusion.

Apto para cocinas de gas, eléctricas, vitrocerámicas y horno.

Suitable for gas, electric, glass-ceramic, oven and induction cookers.

Diseño innovador y exclusivo para un agarre seguro.

Innovative and exclusive design for a secure grip.

Remache exterior especial.

Special external rivet.



INOX 18/10



Sartén Classica
Frypan Classica
Poele Classica
Padella Classica
Pfanne Classica

ALUMINIO FUNDIDO
CAST ALUMINIUM

REF.	Ø(mm / inches)	e(mm)	L(mm)	€	MOQ
10008	240/9,4"	6	50	69,70	1
10009	280/11"	6	52	81,13	1
10010	320/12,5"	6	58	91,19	1
10011	360/14"	6	60	102,76	1



INOX 18/10



Sartén honda Classica
Deep frypan Classica
Poele profonde Classica
Padella profonda Classica
Tiefe pfanne Classica

ALUMINIO FUNDIDO
CAST ALUMINIUM

REF.	Ø(mm / inches)	e(mm)	L(mm)	€	MOQ
10012	240/9,4"	6	70	75,60	1
10013	280/11"	6	70	87,10	1
10014	320/12,5"	6	80	97,87	1
10015	360/14"	6	80	114,33	1

Sartén Ergo



MANGO
BAQUELITA
BAKELITE
HANDLE
200°C



ELDIAMANT[®]
PROFILE



Sartén Ergo Prof
Frypan Ergo Prof
Poele Ergo Prof
Padella Ergo Prof
Pfanne Ergo Prof

ALUMINIO
FUNDIDO
CAST
ALUMINIUM

REF.	Ø(mm/inches)	e(mm)	L(mm)	€	MOQ
10016	200/7,8"	7	50	62,88	1
10017	240/9,4"	7	52	74,02	1
10018	280/11"	7	58	85,08	1
10019	320/12,5"	7	60	106,57	1



ELDIAMANT[®]
PROFILE



Sartén honda Ergo Prof
Deep frying pan Ergo Prof
Poele profonda Ergo Prof
Padella profonda Ergo Prof
Tiefe pfanne Ergo Prof

ALUMINIO
FUNDIDO
CAST
ALUMINIUM

REF.	Ø(mm/inches)	ml	e(mm)	L(mm)	€	MOQ
10020	240/9,4"	200	9	80	81,42	1
10021	280/11"	300	9	85	95,14	1



Whitford



Grill mango silicona abatible
Grill "xl"43x26 wood folding handle
gril manche rabattable 43*26
griglia maniglie estraibile 43*26
gril ausziehbar griff 43*26

REF.	WxL(mm)	ml	e(mm)	H(mm)	€	MOQ
10811	260x330	-	6	50	52,98	1



Disponible en 3 colores
Available in 3 colours



Plancha burger
Burger griddle
Plancha burger
Piastra burger
Grillplatte burger

Whitford

REF.	WxL(mm)	ml	e(mm)	H(mm)	€	MOQ
10073	300x225	-	6	30	65,02	1



MANGO
BAQUELITA
BAKELITE
HANDLE
200°C

Grill asa BK
Grill BK handle
Gril asa BK
Griglia manico BK
Grillgriff BK

ELDIAMANT[®]
PROFILE

REF.	Ø(mm/inches)	ml	e(mm)	H(mm)	€	MOQ
10044	260x260	-	7	40	70,21	1



MANGO
BAQUELITA
BAKELITE
HANDLE
200°C

Wok mango BK
Wok BK handle
Wok manche BK
Wok maniglie BK
Wok Griff BK

Teflon
Maximum
Life
Scratch
Resistance
Best
Performance
PLATINUM PLUS

REF.	Ø(mm/inches)	ml	e(mm)	H(mm)	€	MOQ
10057	300/11,8"	-	6	90	77,18	1

Cocina / Kitchen



Whitford

Huevo & dulce

Egg & sweet
Oeuf & sucré
Uovo e dolce
Ei & süß



PORCIÓN INDIVIDUAL
INDIVIDUAL PORTION

REF.	Ø (mm/inches)	ml	e (mm)	L (mm)	€	MOQ
10022	140/5,5"	-	5	30	24,00	1

Horno / Especial

Oven / Special

Whitford

Mini finger grill

Mini finger grill
Mini finger grill
Mini finger griglia
Mini finger grillpfanne



PORCIÓN INDIVIDUAL
INDIVIDUAL PORTION

REF.	WxL (mm/inches)	ml	e (mm)	H (mm)	€	MOQ
10025	320x16 126"x6,2"	-	5	30	36,51	1



ELDIAMANT*
PROFILE

Mini cacerola

Mini saucepan
Mini casserole
Mini casseruola
Mini kasserolle



COMPATIBLE CON (P.311)

10064 - 10065



REF.	Ø (mm/inches)	ml	e (mm)	H (mm)	€	MOQ
10023	160/6,2"	100	5	68	42,40	1
10024	200/7,8"	150	5	70	47,28	1



ELDIAMANT*
PROFILE

Cacerola grand gourmet

Grand gourmet saucepan
Casserole grand gourmet
Casseruola grand gourmet
Kasserolle grand gourmet



COMPATIBLE CON (P. 311)

10066 - 10067 - 10068 - 10069



REF.	Ø (mm/inches)	ml	e (mm)	L (mm)	€	MOQ
10027	240/9,4"	200	6	70	48,97	1
10028	280/11"	300	6	75	60,33	1
10029	320/12,5"	450	6	85	70,26	1
10030	360/14,1"	550	6	85	94,04	1



ELDIAMANT*
PROFILE

Cacerola alta grand gourmet

Grand gourmet high saucepan
Casserole haute grand gourmet
Casseruola alta grand gourmet
Hohe Kasserolle grand gourmet



COMPATIBLE CON (P. 311)

10065 - 10066 - 10067



REF.	Ø (mm/inches)	ml	e (mm)	L (mm)	€	MOQ
10031	200/7,8"	250	6	105	57,20	1
10032	240/9,44"	350	6	106	68,91	1
10033	280/11"	450	6	110	88,82	1



ELDIAMANT*
PROFILE

Cazo 1 mango grand gourmet

Grand gourmet pot 1 handle
Casserole 1 manche grand gourmet
Casseruola 1 mangico grand gourmet
Kasserolle 1 griff grand gourmet



MANGO
BAQUELITA
BAKELITE
HANDLE
200°C

COMPATIBLE CON (P. 311)

10064



REF.	Ø (mm/inches)	ml	e (mm)	L (mm)	€	MOQ
10034	160/6,2"	150	5	102	42,40	1

Aluminio Fundido / Cast Aluminium



Le Pignatte

Cocción lenta / Slow Cooking



Le Pignatte®



Más fácil de limpiar
Easier to clean



Más ligera que el hierro fundido
Lighter than cast iron



Mejor presentación
Better performance



ELDIAMANT*
PROFILE



Cacerola de cocción lenta "Le Pignatte"

Slow cooking saucepot "Le Pignatte"
Casserole à la mijoteuse "Le Pignatte"
Casseruola a cottura lenta "Le Pignatte"
Kasserolle langsamen Kochen "Le Pignatte"



REF.	Ø (mm/inches)	ml	e (mm)	L (mm)	€	MOQ
10035	200/7,8"	225	7	101	125,68	1
10036	240/9,4"	350	7	106	143,58	1
10037	280/11"	450	7	114	161,26	1

RISOLI

IL PRESSOFUSO IN CUCINA



Ver condiciones página 25 / See conditions page 25



Ondulación para una mayor circulación del aire en el horno.
Undulation for greater air circulation in the oven.

Whitford

Grill pizza
Grill pizza
Gril pizza
Griglia pizza
Grill pizza



REF.	WxL(mm)	ml	e(mm)	H(mm)	€	MOQ
10041	400x340	-	8	30	77,18	1



Grill barbacoa
Grilled barbecue
Gril barbecue
Piastra barbecue
Grill grillen

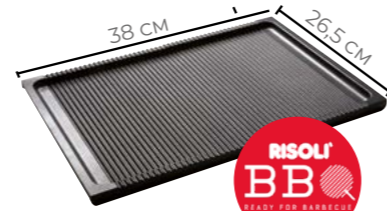

REF.	WxL(mm)	ml	e(mm)	H(mm)	€	MOQ
10038	380x265	-	6	20	68,77	1

Whitford

Grill para pinchos
Brochette grill
Gril à brochette
Griglia per spiedini
Grill für spieße



REF.	WxL(mm)	ml	e(mm)	H(mm)	€	MOQ
10040	470x260	-	6	50	74,59	1

Whitford

Placa grill doble
Dual grill plate
Plaque de grill double
Piastra dual grill
Doppelte grillplatte



REF.	WxL(mm)	ml	e(mm)	H(mm)	€	MOQ
10071	300x225	-	5	20	39,43	1

Whitford

Plancha grill
Servigrill
Plaque de grill
Piastra grigliata
Grillplatte



REF.	WxL(mm)	ml	e(mm)	H(mm)	€	MOQ
10042	460x250	-	6	30	90,40	1
10735	460x250	-	6	30	88,28	1

Whitford

Grill horno
Oven grill
Gril four
Griglia forno
Grill ofen



REF.	WxL(mm)	ml	e(mm)	H(mm)	€	MOQ
10072	360x180	-	5	18	40,56	1



Sartén ovalada para pescado
Oval fish pan
Poêle à poisson ovale
Pesciera ovale
Ovale Fischpfanne



ALUMINIO
FUNDIDO
CAST
ALUMINIUM

REF.	WxL (mm/inches)	ml	€	MOQ
10039	460x26,5	-	59,93	1



Tapa vidrio
Glass Lid
Couvercle verre
Coperchio vetro
Glasdeckel

REF.	Ø(mm/inches)	€	MOQ
BOROSILICATO			
10064	160/6,2"	10,56	1
10065	200/7,8"	14,73	1
10066	240/9,4"	15,81	1
10067	280/11"	18,97	1
10068	320/12,5"	20,55	1
VIDRIO TEMPLADO			
10069	360/14,1"	19,91	1



Disco inductor universal
Universal inductor disc
Disque inducteur universel
Disco induttore universale
Universal-induktorscheibe

REF.	Ø(mm)	ml	€	MOQ
10070	260	-	46,39	1



Salvamantel silicona verde
Silicone trivet green
Sottopivetto in silicone verde
Dessous de plat silicone vert
Untersatz aus silikon grün

REF.	WxL(mm)	H(mm)	€	MOQ
10813	170x170	3	11,54	1
10814	190x190	3	21,05	1



Set 2 agarraderas silicona negro
Set 2 silicone handle black
Set 2 manici in silicone nero
Set 2 manche en silicone noir
Set 2 silikongriff schwarz

REF.	€	MOQ
10812	14,26	1



Estructura de placa de aleación de aluminio con conductividad térmica muy alta e indeformable.

Certificado antiadherente de alta calidad.

Zonas de desague de cocina para no mezclar los sabores.



Rayadura y relieves para evitar el efecto fritura.

Borde con bridas que permite la inserción en el bastidor del horno.



* Nicola Ostinelli
Proprietario del restaurante Il Diavolo
L'acqua Santa



Plancha grill GN 1/1
GN 1/1 grill
Plaque de cuisson GN 1/1
Piastra Griglia GN 1/1
Grill Platte GN 1/1

REF.	WxL(mm)	ml	e _(mm)	H _(mm)	€	MOQ
10045	530x325	-	7	20	221,33	1

CUBETA GN EN ALUMINIO CON ANTIADHERENTE HARD STONE
Aluminium Baking Pans With non-stick coating

**ANTIADHERENTE
HARD-STONE**
MASSIMA ANTIADERENZA - MAGGIORE DURATA



MOD. 1/1

REF.	WxL(mm)	ml	e _(mm)	H _(mm)	€	MOQ
10046	530x325	-	1,5	20	51,24	1
10047	530x325	-	1,5	40	57,20	1
10048	530x325	-	1,5	65	67,84	1

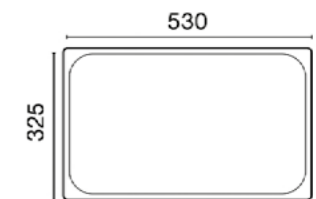

**ANTIADHERENTE
HARD-STONE**
MASSIMA ANTIADERENZA - MAGGIORE DURATA



MOD. 2/3

REF.	WxL(mm)	ml	e _(mm)	H _(mm)	€	MOQ
10049	355x325	-	6	20	37,94	1
10050	355x325	-		40	42,40	1
10051	355x325	-		65	49,80	1

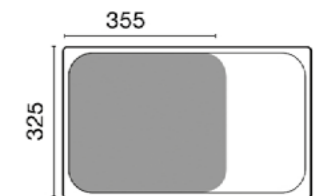

**ANTIADHERENTE
HARD-STONE**
MASSIMA ANTIADERENZA - MAGGIORE DURATA



MOD. 1/2

MOQ 1 UNIDAD

REF.	WxL(mm)	ml	e _(mm)	H _(mm)	€	MOQ
10052	265x325	-	1,5	20	31,33	1
10053	265x325	-	1,5	40	34,92	1

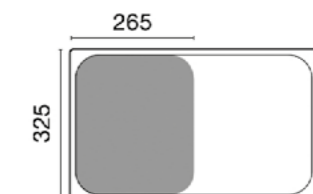

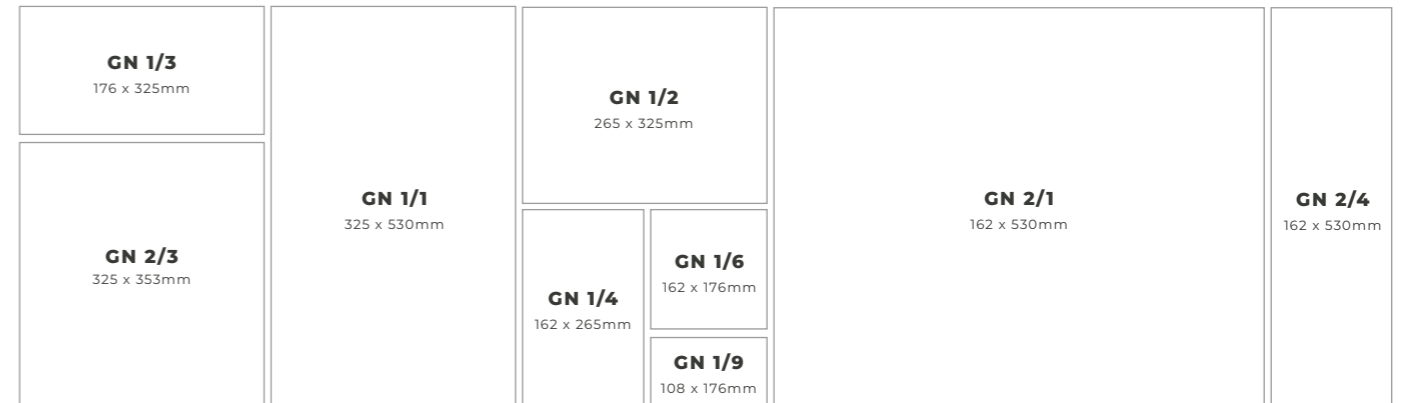

*medidas interiores / internal dimensions



CUBETAS CONTAINERS

INOX 18/10
INOX 18/10



Alta calidad garantizada.
High quality guaranteed.

Fácil limpieza.
Easy cleaning.

Resistencia a la corrosión.
Corrosion resistance.

Máxima capacidad.
Maximum capacity.

POLICARBONATO
POLYCARBONATE



Alta calidad garantizada.
High quality guaranteed.

Fácil limpieza.
Easy cleaning.

Temperatura de -40°C a 110°C.
Temperature from -40°C to 110°C.

Excelente transparencia.
Excellent transparency.

POLIPROPILENO
POLYPROPYLENE



Alta calidad garantizada.
High quality guaranteed.

Cerrado hermético.
hermetically sealed.

Temperatura de -40°C a 80°C.
Temperature from -40°C to 80°C.

Apto para microondas.
Microwave safe.

Características
Characteristics

MATERIAL MATERIAL	TEMPERATURA TEMPERATURE	EXPOSICIÓN A LAS LLAMAS FLAME EXPOSURE	LIMPIEZA CLEANING	RESISTENCIA A LA CORROSIÓN CORROSION RESISTANCE
----------------------	----------------------------	---	----------------------	--

AISI 304

Máximo 280°C
Maximum 280°C

Evitar
Avoid

Fácil
Easy



GN 1/1
325 x 530mm

Cubeta GN 1/1
GN-container 1/1
Bac GN 1/1
Contenitori GN 1/1
GN behälter 1/1



REF.	H(mm)	THK(mm)	€
10147	20	0,8	20,45
10148	40	0,8	21,66
10149	55	0,8	25,82
10150	65	0,7	24,15
10151	100	0,7	31,92
10153	150	0,8	41,80
10154	200	0,8	56,60

Cubeta GN perforada 1/1
Perforated GN-container 1/1
Bac perforé GN 1/1
Contenitori forate GN 1/1
Perforierte behälter GN 1/1



REF.	H(mm)	€
10220	20	28,11
10221	40	28,68
10222	55	33,33
10223	65	31,56
10224	100	43,62
10225	150	67,75
10226	200	83,97

GN 1/2
265 x 325mm

Cubeta GN 1/2
GN-container 1/2
Bac GN 1/2
Contenitori GN 1/2
GN behälter 1/2



REF.	H(mm)	THK(mm)	€
10164	20	0,6	12,54
10166	40	0,6	14,54
10168	65	0,6	17,08
10170	100	0,6	21,31
10172	150	0,7	27,42
10173	200	08	38,45

Cubeta GN perforada 1/2
Perforated GN-container 1/2
Bac perforé GN 1/2
Contenitori forate GN 1/2
Perforierte behälter GN 1/2



REF.	H(mm)	€
10433	40	17,75
10234	65	19,95
10235	100	26,58
10236	150	41,88
10237	200	52,26

GN 1/3
176 x 325mm

Cubeta GN 1/3
GN-container 1/3
Bac GN 1/3
Contenitori GN 1/3
GN behälter 1/3



REF.	H(mm)	THK(mm)	€
10179	20	0,6	11,04
10181	40	0,6	12,50
10183	65	0,6	13,93
10185	100	0,6	18,05
10187	150	0,7	24,25
10188	200	0,8	32,11

Cubeta GN perforada 1/3
Perforated GN-container 1/3
Bac perforé GN 1/3
Contenitori forate GN 1/3
Perforierte GN behälter 1/3



REF.	H(mm)	€
10238	40	13,71
10239	65	16,62
10240	100	22,47
10241	150	32,64
10242	200	44,13



Cubeta GN 1/4
GN-container 1/4
Bac GN 1/4
Contentitori GN 1/4
GN behälter GN 1/4



REF.	H(mm)	THK(mm)	€
10190	20	0,6	9,73
10432	40	0,7	12,85
10192	65	0,6	11,60
10194	100	0,6	15,68
10195	150	0,7	21,88
10196	200	0,8	26,88



Cubeta GN 1/6
GN-container 1/6
Bac GN 1/6
Contentitori GN 1/6
GN behälter GN 1/6



REF.	H(mm)	THK(mm)	€
10197	65	0,7	9,90
10199	100	0,6	12,13
10200	150	0,8	18,38
10201	200	1,0	28,50

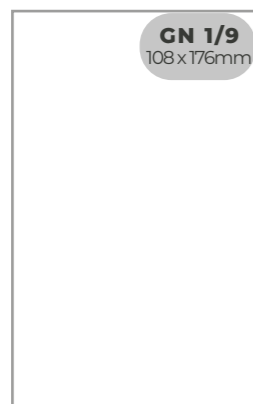

Cubeta GN 1/9
GN-container 1/9
Bac GN 1/9
Contentitori GN 1/9
GN behälter GN 1/9



REF.	H(mm)	THK(mm)	€
10203	65	0,6	8,58
10205	100	0,7	12,38



Cubeta GN 2/4
GN-container 2/4
Bac GN 2/4
Contentitori GN 2/4
GN behälter GN 2/4



REF.	H(mm)	THK(mm)	€
10175	65	0,7	23,25
10176	100	0,7	30,55
10177	150	0,8	40,00



Cubeta GN 2/1
GN-container 2/1
Bac GN 2/1
Contentitori GN 2/1
GN behälter GN 2/1



REF.	H(mm)	THK(mm)	€
10141	20	1,0	47,20
10142	40	1,0	49,52
10143	65	0,8	50,50
10144	100	1,0	66,90
10145	150	1,0	92,09
10146	200	1,0	104,50

Cubeta GN perforada 2/1
Perforated GN-container 2/1
Bac Perforé GN 2/1
Contentitori forate GN 2/1
Perforierte GN behälter GN 2/1



REF.	H(mm)	€
10214	20	55,63
10215	40	58,54
10216	65	68,79
10217	100	87,25
10218	150	122,75
10219	200	150,38

Cubeta GN 2/3
GN-container 2/3
Bac GN 2/3
Contentitori GN 2/3
GN behälter GN 2/3



REF.	H(mm)	THK(mm)	€
10155	20	0,7	16,75
10157	40	0,6	19,11
10159	65	0,6	21,59
10160	100	0,7	30,50
10161	150	0,8	43,25
10162	200	0,8	54,00

Cubeta GN perforada 2/3
Perforated GN-container 2/3
Bac perforé GN 2/3
Contentitori forate GN 2/3
Perforierte GN behälter GN 2/3



REF.	H(mm)	€
10227	20	19,23
10228	40	22,56
10230	65	21,32
10231	100	30,78
10232	150	47,90
10233	200	65,37



Perfil divisorio gastronorm

Adaptable bars
Barrettes de composition
Separatore
Adapter



REF.	FORMATO	€
10212	GN 1/1	6,72
10213	GN 1/2	4,42

Fondo perforado

Perforated bottom
Egouttoirs pour bacs
Falso fondo forato
Abtropfgitter



REF.	W(mm)	L(mm)	FORMATO	€
10206	470	590	GN 2/1	54,10
10207	469	269	GN 1/1	27,60
10209	271	211	GN 1/2	14,75
10210	266	116	GN 1/3	15,50
10211	118	106	GN 1/6	10,40



Tapa GN

GN lid
Couvercle GN
Coperchio GN
GN-deckel



REF.	W(mm)	L(mm)	FORMATO	€
10243	530	325	GN 1/1	22,50
10245	325	355	GN 2/3	17,68
10247	325	265	GN 1/2	12,88
10249	325	175	GN 1/3	10,30
10251	162	264	GN 1/4	8,70
10253	162	176	GN 1/6	6,55
10255	108	176	GN 1/9	5,75

Tapa GN cierre hermético

GN hermetic lid
Couvercle étanche GN
Coperchio ermetico gn
GN-steck-deckel



REF.	W(mm)	L(mm)	FORMATO	€
10258	530	325	GN 1/1	64,53
10259	325	265	GN 1/2	45,51
10260	325	175	GN 1/3	36,23
10261	162	264	GN 1/4	28,30
10262	162	176	GN 1/6	26,33

Tapa GN con orificio asas

GN lid with hole for handles
Couvercle GN avec trou pour poignées
Coperchio GN con foro per maniglie
GN-deckel Loch für Griffe

REF.	W(mm)	L(mm)	FORMATO	€
10263	530	325	GN 1/1	27,50
10264	325	355	GN 2/3	22,08
10265	325	265	GN 1/2	18,83
10266	325	175	GN 1/3	13,75
10267	162	264	GN 1/4	13,06
10268	162	176	GN 1/6	10,00

Tapa GN con orificio cucharón

GN lid with ladle hole
Couvercle GN avec trou pour louche
Coperchio GN con foro mestolo
GN deckel loch kelle 1/1

REF.	W(mm)	L(mm)	FORMATO	€
10269	530	325	GN 1/1	27,63
10270	325	265	GN 1/2	17,49
10271	325	175	GN 1/3	12,50
10272	162	264	GN 1/4	11,49
10273	162	176	GN 1/6	8,75

Tapa plana GN sin asa

GN flat lid without handle
Couvercle plat GN sans poignée
Coperchio piatto GN senza manico
GN-Flachdeckel ohne Griff

REF.	W(mm)	L(mm)	FORMATO	€
10256	530	325	GN 1/1	24,25
10257	325	265	GN 1/2	13,38



Cubeta GN 1/1
GN-container 1/1
Bac GN 1/1
Contentitori GN 1/1
GN behälter GN 1/1



Cubeta GN perforada 1/1
Perforated GN-container 1/1
Bac perforé GN 1/1
Contentitori forate GN 1/1
Perforierte behälter GN 1/1



REF.	H(mm)	THK(mm)	LT	€	UE / MOQ
10566	20	0,7		11,88	1-10-50-200-1000 / 10
10567	40	0,7		15,50	1-10-50-200-1000 / 10
10568	55	0,7		18,92	1-10-50-200-1000 / 10
10569	65	0,7	8,8	17,50	1-10-50-200-1000 / 10
10570	100	0,7	13,7	23,25	1-10-50-200-1000 / 10
10571	150	0,7	20	34,40	1-10-50-200-1000 / 10
10572	200	0,7	27,8	40,83	1-10-50-200-1000 / 10

REF.	H(mm)	€	UE / MOQ
10617	65	20,13	1-10-50-200-1000 / 10
10618	100	23,38	1-10-50-200-1000 / 10
10619	150	37,38	1-10-50-200-1000 / 10
10620	200	45,29	1-10-50-200-1000 / 10

Cubeta GN 1/2
GN-container 1/2
Bac GN 1/2
Contentitori GN 1/2
GN behälter GN 1/2



Cubeta GN perforada 1/2
Perforated GN-container 1/2
Bac perforé GN 1/2
Contentitori forate GN 1/2
Perforierte behälter GN 1/2



REF.	H(mm)	THK(mm)	LT	€	UE / MOQ
10573	20	0,7		7,00	1-10-50-200-1000 / 10
10574	40	0,7		9,68	1-10-50-200-1000 / 10
10575	65	0,7	4	11,00	1-10-50-200-1000 / 10
10576	100	0,7	6,1	15,00	1-10-50-200-1000 / 10
10577	150	0,7	9,2	21,00	1-10-50-200-1000 / 10
10578	200	0,7	12	26,63	1-10-50-200-1000 / 10

REF.	H(mm)	€	UE / MOQ
10621	65	11,09	1-10-50-200-1000 / 10
10622	100	14,99	1-10-50-200-1000 / 10

Cubeta GN 1/3
GN-container 1/3
Bac GN 1/3
Contentitori GN 1/3
GN behälter GN 1/3



REF.	H(mm)	THK(mm)	LT	€	UE / MOQ
10579	20	0,7		5,45	1-10-50-200-1000 / 10
10580	40	0,7		7,73	1-10-50-200-1000 / 10
10581	65	0,7	2,4	8,17	1-10-50-200-1000 / 10
10582	100	0,7	3,5	11,88	1-10-50-200-1000 / 10
10583	150	0,7	5,4	16,10	1-10-50-200-1000 / 10
10584	200	0,7	7,2	20,00	1-10-50-200-1000 / 10

Cubeta GN 1/6
GN-container 1/6
Bac GN 1/6
Contentitori GN 1/6
GN behälter GN 1/6



REF.	H(mm)	THK(mm)	LT	€	UE / MOQ
10591	65	0,7	1	5,68	1-10-50-200-1000 / 10
10592	100	0,7	1,5	7,63	1-10-50-200-1000 / 10
10593	150	0,7	2,3	11,13	1-10-50-200-1000 / 10
10594	200	0,7	3,3	13,75	1-10-50-200-1000 / 10

Doble fondo perforado
Perforated bottom
Egouttoirs pour bacs
Falso fondo forato
Abtropfgitter



REF.	FORMATO	€	UE / MOQ
10612	GN 1/1	16,88	1-10-50-200-1000 / 10

Tapa GN inox
GN lid
Couvercle GN
Coperchio GN
GN-deckel



REF.	W(mm)	Lj(mm)	FORMATO	€	UE / MOQ
10630	530	325	GN 1/1	15,37	1-10-50-200
10632	325	265	GN 1/2	7,55	1-10-50-200
10633	325	175	GN 1/3	5,77	1-10-50-200
10634	162	264	GN 1/4	5,33	1-10-50-200
10635	162	176	GN 1/6	3,65	1-10-50-200
10636	108	176	GN 1/9	2,63	1-10-50-200

Cubeta GN 1/4
GN-container 1/4
Bac GN 1/4
Contentitori GN 1/4
GN behälter GN 1/4



REF.	H(mm)	THK(mm)	LT	€	UE / MOQ
10585	20	0,7		5,65	1-10-50-200-1000 / 10
10586	40	0,7		7,07	1-10-50-200-1000 / 10
10587	65	0,7	1,7	7,11	1-10-50-200-1000 / 10
10588	100	0,7	2,5	9,63	1-10-50-200-1000 / 10
10589	150	0,7	3,8	14,00	1-10-50-200-1000 / 10
10590	200	0,7	4,8	16,25	1-10-50-200-1000 / 10

Cubeta GN 1/9
GN-container 1/9
Bac GN 1/9
Contentitori GN 1/9
GN behälter GN 1/9



REF.	H(mm)	THK(mm)	LT	€	UE / MOQ
10595	65	0,7	0,6	4,17	1-10-50-200-1000 / 10
10596	100	0,7	0,8	6,15	1-10-50-200-1000 / 10

Perfil divisorio GN
Adaptable bars
Barrettes de composition
Separatore
Adapter



REF.	FORMATO	€	UE / MOQ
10614	GN 1/1	5,88	1-10-50-200-1000 / 10
10615	GN 1/2	3,68	1-10-50-200-1000 / 10

Tapa GN cierre hermético
GN hermetic lid
Couvercle étanche GN
Coperchio ermetico gn
GN-steck-deckel



REF.	W(mm)	Lj(mm)	FORMATO	€
10637	530	325	GN 1/1	36,55
10638	325	265	GN 1/2	23,88
10639	325	175	GN 1/3	20,88
10640	162	264	GN 1/4	17,75
10641	162	176	GN 1/6	14,50

Características
Characteristics

MATERIAL MATERIAL	TEMPERATURA TEMPERATURE	RESISTENCIA AL IMPACTO IMPACT RESISTANCE	LAVAVAJILLAS DISHWASHER	RESISTENCIA QUIMICA CHEMICALS RESISTANCE
No BPA-free Not BPA-free	-40° / 110°C	Alta High	✓	Moderada Moderate
CLARIDAD CLARITY	RESISTENCIA A LAS MANCHAS STAIN RESISTANCE	RESISTENCIA AL RAYADO SCRATCH RESISTANCE	MICROONDAS MICROWAVE	RECICLABLE RECYCLABLE
Transparente Clear	Moderada Moderate	Moderada Moderate	No recomendable Not recommended	✓



GN 1/1
325 x 530mm



GN 1/2
265 x 325mm

Cubeta policarbonato 1/1
Polycarbonate container 1/1
Bac polycarbonate 1/1
Contentori policarbonato 1/1
Behälter aus polycarbonat 1/1



REF.	COLOR	H(mm)	THK(mm)	€
10274	○	65	2,6	16,13
10299	●	65	2,6	18,95
10275	○	100	2,7	20,13
10300	●	100	2,7	23,00
10276	○	150	2,9	24,63
10301	●	150	2,9	27,45
10277	○	200	3,0	31,50

Cubeta policarbonato 1/2
Polycarbonate container 1/2
Bac polycarbonate 1/2
Contentori policarbonato 1/2
Behälter aus polycarbonat 1/2



REF.	COLOR	H(mm)	THK(mm)	€
10278	○	65	2,6	9,38
10302	●	65	2,6	10,23
10279	○	100	2,6	11,30
10303	●	100	2,6	11,82
10280	○	150	2,6	13,38
10304	●	150	2,6	16,95
10281	○	200	2,6	16,95



Cubeta policarbonato 1/3
Polycarbonate container 1/3
Bac polycarbonate 1/3
Contentitori policarbonato 1/3
Behälter aus polycarbonat 1/3



REF.	COLOR	H(mm)	THK(mm)	€
10282	○	65	2,6	7,13
10305	●	65	2,6	7,77
10283	○	100	2,6	8,70
10306	●	100	2,6	9,15
10284	○	150	2,6	10,88
10307	●	150	2,6	12,27
10285	○	200	2,7	13,25



Cubeta policarbonato 1/4
Polycarbonate container 1/4
Bac polycarbonate 1/4
Contentitori policarbonato 1/4
Behälter aus polycarbonat 1/4



REF.	COLOR	H(mm)	THK(mm)	€
10286	○	65	2,3	5,82
10308	●	65	2,3	6,00
10287	○	100	2,3	6,97
10309	●	100	2,3	6,97
10288	○	150	2,5	8,91
10310	●	150	2,5	9,91



Cubeta policarbonato 1/6
Polycarbonate container 1/6
Bac polycarbonate 1/6
Contentitori policarbonato 1/6
Behälter aus polycarbonat 1/6



REF.	COLOR	H(mm)	THK(mm)	€
10289	○	65	2,3	4,26
10311	●	65	2,3	4,51
10290	○	100	2,5	5,03
10312	●	100	2,5	5,30
10291	○	150	2,5	6,63
10313	●	150	2,5	7,77



Cubeta policarbonato 1/9
Polycarbonate container 1/9
Bac polycarbonate 1/9
Contentitori policarbonato 1/9
Behälter aus polycarbonat 1/9



REF.	COLOR	H(mm)	THK(mm)	€
10314	●	65	2,0	3,22
10292	○	100	2,0	3,57
10315	●	100	2,0	3,78



Tapa policarbonato
Polycarbonate lid
Couvercle polycarbonate
Coperchio policarbonato
Deckel polycarbonat

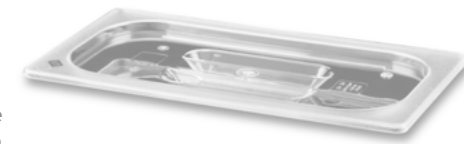

REF.	COLOR	W(mm)	L(mm)	FORMATO	€
10293	○	530	325	GN 1/1	12,20
10316	●	530	325	GN 1/1	14,46
10294	○	325	265	GN 1/2	7,00
10317	●	325	265	GN 1/2	7,70
10295	○	325	175	GN 1/3	5,17
10318	●	325	175	GN 1/3	5,30
10296	○	162	264	GN 1/4	4,40
10319	●	162	264	GN 1/4	4,61
10297	○	162	176	GN 1/6	3,29
10320	●	162	176	GN 1/6	3,50
10298	○	176	108	GN 1/9	2,46
10321	●	176	108	GN 1/9	2,53

Doble fondo perforado policarbonato
Polycarbonate perforated double bottom
Double egouttoirs pour bacs polycarbonate
Falso fondo policarbonato
Abtropfgitter polycarbonat



REF.	FORMATO	€
10322	GN 1/1	8,77
10323	GN 1/2	4,61
10324	GN 1/3	3,19
10325	GN 1/6	2,15

Características
Characteristics



Cubeta con etiqueta estandar IML HACCP
Bucket with standard IML HACCP label



Etiqueta personalizada IML HACCP
Personalized IML HACCP label

- **MOQ:** 300 unidades por referencia
- **Mínimo:** 20.000 etiquetas a 0,13€/u

MATERIAL MATERIAL	TEMPERATURA TEMPERATURE	RESISTENCIA AL IMPACTO IMPACT RESISTANCE	LAVAVAJILLAS DISHWASHER	RESISTENCIA QUIMICA CHEMICALS RESISTANCE
BPA-free	-40° / 80°C	Buena Good		Alta High
CLARIDAD CLARITY	RESISTENCIA A LAS MANCHAS STAIN RESISTANCE	RESISTENCIA AL RAYADO SCRATCH RESISTANCE	MICROONDAS MICROWAVE	RECICLABLE RECYCLABLE
Translúcido Translucent	Moderada Moderate	Moderada Moderate	No recomendable Not recommended	

GN 1/1
325 x 530mm

Cubeta polipropileno 1/1
Polypropylene container 1/1
Bac polypropylène 1/1
Contentitori polipropilene 1/1
Behälter aus polypropylen 1/1

REF.	H(mm)	THK(mm)	€
10326	65	2,5	10,38
10327	100	2,6	12,85
10328	150	2,8	13,88
10329	200	2,9	17,48

GN 1/2
265 x 325mm

Cubeta polipropileno 1/2
Polypropylene container 1/2
Bac polypropylène 1/2
Contentitori polipropilene 1/2
Behälter aus polypropylen 1/2

REF.	H(mm)	THK(mm)	€
10330	65	2,5	5,65
10331	100	2,5	6,73
10332	150	2,5	8,25
10333	200	2,5	9,50

GN 1/3
176 x 325cm

Cubeta polipropileno 1/3
Polypropylene container 1/3
Bac polypropylène 1/3
Contentitori polipropilene 1/3
Behälter aus polypropylen 1/3

REF.	H(mm)	THK(mm)	€
10334	65	2,5	4,50
10335	100	2,55	5,43
10336	150	2,6	6,73
10337	200	2,65	8,05



Cubeta polipropileno 1/1 con etiqueta IML HACCP
Polypropylene container 1/1 with IML HACCP label
Bac polypropylène 1/1 avec étiquette IML HACCP
Contentitori polipropilene 1/1 con etichetta IML HACCP
Behälter aus polypropylen 1/1 mit IML-HACCP-Etikett

REF.	H(mm)	€
10435	65	13,08
10436	100	15,29
10437	150	17,36
10438	200	20,63



Cubeta polipropileno 1/2 con etiqueta IML HACCP
Polypropylene container 1/2 with IML HACCP label
Bac polypropylène 1/2 avec étiquette IML HACCP
Contentitori polipropilene 1/2 con etichetta IML HACCP
Behälter aus polypropylen 1/2 mit IML-HACCP-Etikett

REF.	H(mm)	€
10439	65	7,89
10440	100	8,76
10441	150	10,40
10442	200	12,51



Cubeta polipropileno 1/3 con etiqueta IML HACCP
Polypropylene container 1/3 with IML HACCP label
Bac polypropylène 1/3 avec étiquette IML HACCP
Contentitori polipropilene 1/3 con etichetta IML HACCP
Behälter aus polypropylen 1/3 mit IML-HACCP-Etikett

REF.	H(mm)	€
10443	65	6,00
10444	100	7,49
10445	150	8,83
10446	200	10,57

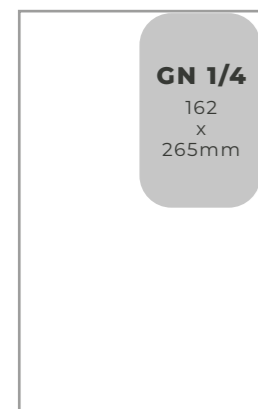

Cubeta polipropileno 1/4
Polypropylene container 1/4
Bac polypropylène 1/4
Contentitori polipropilene 1/4
Behälter aus polypropylen 1/4

REF.	H(mm)	THK(mm)	€
10338	65	2,3	3,88
10339	100	2,3	4,75
10340	150	2,5	5,43
10407	200	2,6	7,23



Cubeta polipropileno 1/4 con etiqueta IML HACCP
Polypropylene container 1/4 with IML HACCP label
Bac polypropylène 1/4 avec étiquette IML HACCP
Contentitori polipropilene 1/4 con etichetta IML HACCP
Behälter aus polypropylen 1/4 mit IML-HACCP-Etikett

REF.	H(mm)	€
10447	65	4,83
10448	100	5,58
10449	150	7,13
10450	200	9,37



Cubeta polipropileno 1/6
Polypropylene container 1/6
Bac polypropylène 1/6
Contentitori polipropilene 1/6
Behälter aus polypropylen 1/6

REF.	H(mm)	THK(mm)	€
10341	65	2,3	3,17
10342	100	2,4	3,67
10343	150	2,5	4,68
10457	200	2,6	6,00



Cubeta polipropileno 1/6 con etiqueta IML HACCP
Polypropylene container 1/6 with IML HACCP label
Bac polypropylène 1/6 avec étiquette IML HACCP
Contentitori polipropilene 1/6 con etichetta IML HACCP
Behälter aus polypropylen 1/6 mit IML-HACCP-Etikett

REF.	H(mm)	€
10451	65	4,13
10452	100	4,75
10453	150	5,75
10454	200	6,69

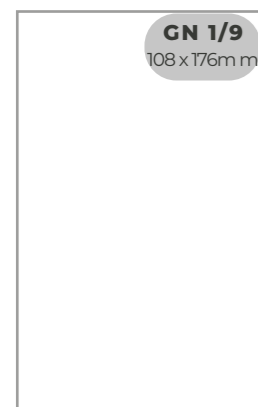

Cubeta polipropileno 1/9
Polypropylene container 1/9
Bac polypropylène 1/9
Contentitori polipropilene 1/9
Behälter aus polypropylen 1/9

REF.	H(mm)	THK(mm)	€
10344	65	1,9	2,40
10345	100	1,9	2,87



Cubeta polipropileno 1/9 con etiqueta IML HACCP
Polypropylene container 1/9 with IML HACCP label
Bac polypropylène 1/9 avec étiquette IML HACCP
Contentitori polipropilene 1/9 con etichetta IML HACCP
Behälter aus polypropylen 1/9 mit IML-HACCP-Etikett

REF.	H(mm)	€
10455	65	3,30
10456	100	3,88

Doble fondo perforado polipropileno
Polypropylene perforated double bottom
Double égouttoirs pour bacs polypropylène
Falso fondo polipropilene
Abtropfgitter polypropylen

REF.	FORMATO	€
10352	1/1	5,74
10353	1/2	3,61
10354	1/3	2,30
10434	1/6	1,55



Tapa GN polipropileno
Polypropylene lid
Couvercle polypropylène
Coperchio polipropilene
Deckel polypropylen



REF.	W(mm)	L(mm)	FORMATO	€
10346	530	325	1/1	6,28
10347	325	265	1/2	3,10
10348	325	175	1/3	2,44
10349	264	162	1/4	2,17
10350	176	162	1/6	1,64
10351	176	108	1/9	1,44

Tapa GN polipropileno hermética
Polypropylene lid
Couvercle polypropylène
Coperchio polipropilene
Deckel polypropylen



REF.	W(mm)	L(mm)	FORMATO	€
10723	530	325	1/1	16,63
10724	325	265	1/2	11,91
10725	325	175	1/3	8,33
10726	264	162	1/4	6,81
10727	176	162	1/6	6,18
10728	176	108	1/9	5,56

Clips tapa polipropileno
Clips for polypropylene lids
Clips de bouchon en polypropylène
Clips per coperchi in polipropilene
Deckelclips aus Polypropylen

REF.	UNIDADES	€
10466.COLOR	12	6,90

Colores disponibles: violeta, amarillo, azul, verde y rojo.



Marcador HORECA
HORECA marker
Marqueur HORECA
Pennarello HORECA
HORECA-Marker

REF.	UNIDADES	€
10464	1	5,00
10465	2	11,23





Cubeta helado 165 x 360
Ice cream container
Bac crème glacée
Contentori gelateria
Behälter eiscreme



REF.	W(mm)	L(mm)	H(mm)	THK(mm)	LT	€
10395	165	360	120	0,6	5	26,09
10394	165	360	150	0,7	6,5	37,29
10506	165	360	180	0,7	7,7	37,44

Cubeta helado 250 x 360
Ice cream container
Bac crème glacée
Contentori gelateria
Behälter eiscreme



REF.	W(mm)	L(mm)	H(mm)	THK(mm)	LT	€
10509	250	360	80	0,7	5,8	22,29
10510	250	360	120	0,7	8	32,48
10511	250	360	150	0,7	10,8	41,61

Tapa policarbonato transparente
Transparent polycarbonate lid
Couvercle transparent en polycarbonate
Coperchio in policarbonato trasparente
Deckel aus transparentem Polycarbonat



REF.	W(mm)	L(mm)	€
10551	165	360	6,37

Tapa Dome
Dome lid
Couvercle du Dome
Coperchio a Cupola
Kuppelabdeckung



REF.	W(mm)	L(mm)	€
10563	250	360	8,00



Espátula inox 18/10 con mango en Tritan
Spatula stainless steel 18/10 with Tritan handle
Spatule en inox 18/10 avec manche Tritan
Spatola inox 18/10 con manico in PETG
Pfannenwender aus Edelstahl 18/10 mit Tritan-Griff

REF.	L(mm)	€ / TRANSPARENTE	REF.	€ / COLOR
10519	260	7,63	10519 + COLOR	8,37

* Colores disponibles sujetos a disponibilidad de stock:



* Cualquier otro color bajo demanda, mínimo 500 unidades.



Espátula mango Tritan transparente y lente de color
Spatula transparent Tritan handle with color lens
Spatule manche en Tritan transparent et lentille colorée
Spatola manico in Tritan trasparente con lente colorate
Pfannenwender transparentem Tritan-Griff und farbiger Linse

REF.	L(mm)	€
10565 + COLOR	260	9,20

* Colores disponibles sujetos a disponibilidad de stock:



* Cualquier otro color bajo demanda, mínimo 100 unidades.



Espátula inox 18/10 con mango en polipropileno
Spatula stainless steel 18/10 with polypropilene handle
Spatule en inox 18/10 avec manche en polypropylène
Spatola inox 18/10 con manico in polipropilene
Pfannenwender aus Edelstahl 18/10 mit Griff aus Polypropylen

REF.	L(mm)	€
10517 + COLOR	260	6,27

* Colores disponibles sujetos a disponibilidad de stock:



* Cualquier otro color bajo demanda, mínimo 500 unidades.



Espátula mango Tritan transparente y lente personalizada
Spatula transparent Tritan handle with customisable lens
Spatule manche Tritan avec lentille personnalisée
Spatola manico in Tritan trasparente con lente personalizzabile
Pfannenwender Tritan-Griff mit personalisierter Linse

REF.	L(mm)	€
10549	260	8,97

MOQ: 100 unidades.

Vaso flauta policarbonato
Polycarbonate flute glass
Verre flûte en polycarbonate
Flute in policarbonato
Flötenglas aus Polycarbonat



REF.	V(ol)	€ / TRANSPARENTE	REF.	€ / COLOR
10471	13	5,32	10471 + COLOR	5,73

* Colores disponibles sujetos a disponibilidad de stock:



* Cualquier otro color bajo demanda, mínimo 500 unidades.



Vaso policarbonato
Polycarbonate glass
Verre en polycarbonate
Vetro in policarbonato
Glas aus polycarbonat



REF.	V(ℓ)	€/TRANSPARENTE	REF.	€/COLOR
A 10468	6	3,93	10468 + COLOR	3,80
B 10469	20	5,73	10469 + COLOR	5,84
C 10470	33	4,05	10470 + COLOR	4,46
D 10467	45	5,87	10467 + COLOR	6,25

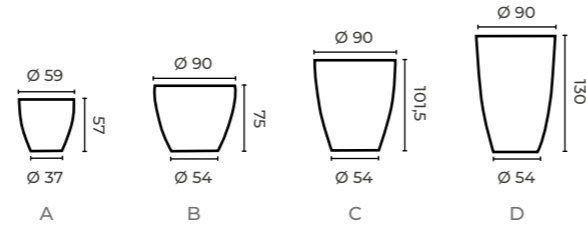

* Colores disponibles sujetos a disponibilidad de stock:



* Cualquier otro color bajo demanda, mínimo 3000 unidades.

Cuenco policarbonato
Polycarbonate bowl
Bol en polycarbonate
Ciotola in policarbonato
Schale aus Polycarbonat



REF.	V(ℓ)	€/TRANSPARENTE	REF.	€/COLOR
A 10484	44	4,19	10484 + COLOR	4,29
B 10485	244	11,19	10485 + COLOR	12,05
C 10486	600	22,90	10486 + COLOR	25,41

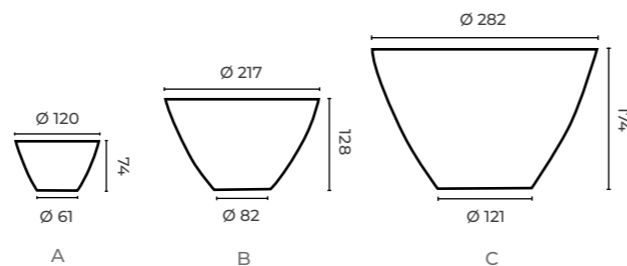

* Colores disponibles sujetos a disponibilidad de stock:



* Cualquier otro color bajo demanda, mínimo 500 unidades.

Vaso policarbonato
Polycarbonate glass
Verre en polycarbonate
Vetro in policarbonato
Glas aus Polycarbonat



REF.	V(ℓ)	€/TRANSPARENTE	REF.	€/COLOR
A 10472	20	2,13	10472 + COLOR	2,20
B 10474	35	2,68	10474 + COLOR	2,78
C 10476	45	3,23	10476 + COLOR	3,33

* Colores disponibles sujetos a disponibilidad de stock:



* Cualquier otro color bajo demanda, mínimo 500 unidades.

Vaso policarbonato satinado
Satin polycarbonate glass
Verre en polycarbonate satiné
Vetro policarbonato satinado
Glas aus transparentem, PC



REF.	V(ℓ)	€/TRANSPARENTE	REF.	€/COLOR
A 10473	20	2,13	10473 + COLOR	2,20
B 10475	35	2,68	10475 + COLOR	2,78
C 10477	45	3,23	10477 + COLOR	3,33

* Colores disponibles sujetos a disponibilidad de stock:



* Cualquier otro color bajo demanda, mínimo 500 unidades.

Vaso polipropileno
Polypropylene glass
Verre en polypropylène
Vetro in polipropilene
Glas aus Polypropylen



REF.	V(ℓ)	€/TRANSPARENTE	REF.	€/COLOR
A 10481	20	1,37	10481 + COLOR	1,58
B 10482	35	1,68	10482 + COLOR	1,89
C 10483	45	1,96	10483 + COLOR	2,20

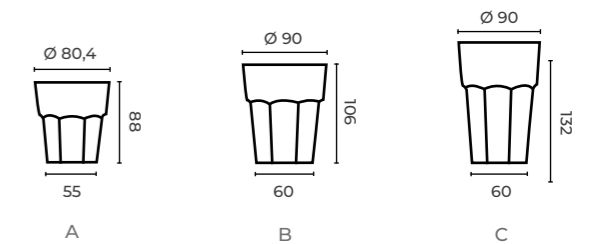

* Colores disponibles sujetos a disponibilidad de stock:



* Cualquier otro color bajo demanda, mínimo 500 unidades.



Personalización con técnica IML

Personalization with IML technique
 Personnalisation avec la technique IML
 Personalizzazione con tecnica IML
 Personalisierung mit IML-Technik

REF.	TIPO IML	V _(cl)	MOQ	€
10481	Etiqueta acoplada estándar Standard coupled label Etiquette couplée standard Etichetta accoppiata normale Gekoppeltes Standard Etikett	20	250	5,80
10481 + COLOR	Etiqueta acoplada estándar Standard coupled label Etiquette couplée standard Etichetta accoppiata normale Gekoppeltes Standard Etikett	20	250	6,17
10482	Etiqueta acoplada estándar Standard coupled label Etiquette couplée standard Etichetta accoppiata normale Gekoppeltes Standard Etikett	35	250	6,03
10482 + COLOR	Etiqueta acoplada estándar Standard coupled label Etiquette couplée standard Etichetta accoppiata normale Gekoppeltes Standard Etikett	35	250	6,37
10483	Etiqueta acoplada estándar Standard coupled label Etiquette couplée standard Etichetta accoppiata normale Gekoppeltes Standard Etikett	45	250	6,27
10483 + COLOR	Etiqueta acoplada estándar Standard coupled label Etiquette couplée standard Etichetta accoppiata normale Gekoppeltes Standard Etikett	45	250	6,57

+ 140€ diseño logotipo

*Sólo se puede realizar la técnica IML en las referencias indicadas. Estos modelos se encuentran en la pág. 335.

*The IML technique can only be performed in the indicated references. These models are found on p. 335.

Personalización con técnica Tampogragfia

Customization with Pad Printing technique
 Personnalisation avec technique de Tampographie
 Personalizzazione con tecnica di Tampografia
 Personalisierung im Tampondruckverfahren

REF.	Nº COLORES	500 pcs	1.000 pcs	2.000 pcs
Se puede realizar en cualquier vaso de policarbonato, polipropileno y Tritan. Can be done in any glass of polycarbonate, polypropylene and Tritan.	1	1,17 €	1,00 €	0,83 €
	2	1,63 €	1,43 €	1,13 €
	3	3,83 €	2,50 €	2,10 €

*Al precio indicado hay que sumarle el precio del vaso escogido.

*To the indicated price you must add the price of the chosen glass.



Personalización con técnica Tampogragfia

Customization with Pad Printing technique
 Personnalisation avec technique de Tampographie
 Personalizzazione con tecnica di Tampografia
 Personalisierung im Tampondruckverfahren

REF.	200 pcs	500 pcs	1.000 pcs
En cualquier vaso de policarbonato y Tritan. In any glass of polycarbonate and Tritan.	0,60 €	0,50 €	0,40 €

*Al precio indicado hay que sumarle el precio del vaso escogido.

*To the indicated price you must add the price of the chosen glass.

Logística

Logistics



LOGÍSTICA LOGISTICS

- 342** CARGADOR FRONTAL (BARTH)
- 344** CONTENEDORES (BARTH)



Asa resistente para transportarla con una sola mano.

Sturdy handle for carrying with one hand.

Caja térmica adecuada que encaja perfectamente y es fácil de usar.

Proper cool box that fits perfectly and is easy to use.

Tapa hermética fácil de abrir y cerrar.

Airtight lid easy to open and close.



Empresa alemana fundada en 2001. Líder del mercado europeo con más de 100 cajas de EPP diferentes para el transporte de productos frescos, calientes o fríos.

German company founded in 2001. European market leader with more than 100 different EPP boxes for the transport of fresh, hot or cold products.



Construcción sólida de una sola pieza

Solid one-piece construction

Borde de agarre práctico

Handy grip edges

Forma compacta

Tightly arranged

Puerta abatible, desmontable

Hinged door, removable

Apilable y ligero

Stackable and lightweight

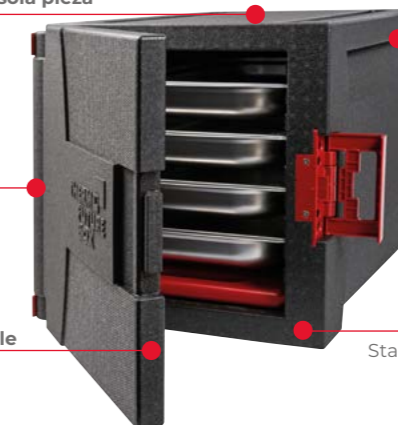

Contenedor isotérmico carga frontal GN 69-9

Thermobox frontloader GN 69-9
Conteneur isotherme à ouverture frontale GN 69-9
Contenitore isothermico per carico frontale GN 69-9
Thermobox frontlader GN 69-9



REF.	COLOR	OUTSIDE			INSIDE			CARRILES(mm)	V(litros)	€
		W(mm)	L(mm)	H(mm)	W(mm)	L(mm)	H(mm)			
10417	●	450	660	490	335	530	390	9 - 38	69	224,71

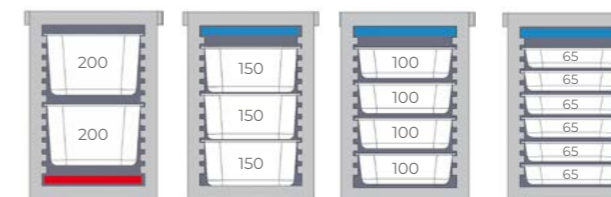

Contenedor isotérmico carga frontal GN 93-12

Thermobox frontloader GN 93-12
Conteneur isotherme à ouverture frontale GN 93-12
Contenitore isothermico per carico frontale GN 93-12
Thermobox frontlader GN 93-12

CIERRE METÁLICO REFORZADO
REINFORCED METAL LOCKING



REF.	COLOR	OUTSIDE			INSIDE			CARRILES(mm)	V(litros)	€
		W(mm)	L(mm)	H(mm)	W(mm)	L(mm)	H(mm)			
10416	●	440	645	625	335	530	525	12 - 32	93	465,73

W: Ancho L: Largo H: Altura
W: Weight L: Large H: High



Disponen de más espacio. Las asas especiales empotradas en el interior, facilitan el cambio de contenedores GN calientes y pesados. Contienen un espacio para poner etiquetas.

They have more space. Special recessed grips inside make changing of hot or heavy GN-containers easier. Special space for labels.



10414

10415

Contenedor isotérmico GN 1/1 DELUXE

Thermobox GN 1/1 DELUXE
Conteneur isotherme GN 1/1 DELUXE
Contentitore isothermico GN 1/1 DELUXE
Thermobox GN 1/1 DELUXE

REF.	OUTSIDE			INSIDE			V (litros)	€
	W (mm)	L (mm)	H (mm)	W (mm)	L (mm)	H (mm)		
10414	400	675	290	325	535	215	37	99,74
10415	400	675	335	325	535	260	45	92,53



10409



10410



10411



10412



10413

Contenedor isotérmico GN 1/1 PREMIUM

Thermobox GN 1/1 PREMIUM
Conteneur isotherme GN 1/1 PREMIUM
Contentitore isothermico GN 1/1 PREMIUM
Thermobox GN 1/1 PREMIUM

REF.	OUTSIDE			INSIDE			V (litros)	€
	W (mm)	L (mm)	H (mm)	W (mm)	L (mm)	H (mm)		
10409	400	600	180	337	538	117	21	60,76
10410	400	600	230	337	538	167	30	63,02
10411	400	600	280	337	538	217	39	66,44
10412	400	600	320	337	538	257	46	69,28
10413	400	600	400	337	538	337	61	91,39

Placa de calor

Hot Pack
Plaque chauffante
Piastra riscaldante
Wärme-akku



REF.	W (mm)	L (mm)	H (mm)	FORMATO	€
10423	325	530	25	GN 1/1	149,40

Calentamiento en el horno (max. 30min a 85°C) y baño maría (max. 30min).
Heating in the oven (max. 30min at 85°C), microwave and bain-marie (max. 30min).

Placa de frío

Cold pack
Plaque eutectique
Piastra eutetica
Kühl-akku



REF.	W (mm)	L (mm)	H (mm)	FORMATO	€
10424	325	530	25	GN 1/1	94,31

Refrigeración en el congelador (max. -12°C).
Cooling in the freezer (max. -12°C).



Caja para las mejores soluciones logísticas. Tamaño de embalaje optimizado, apilable con los contenedores más comunes, adecuado para contenedores de tamaño GN.

Box for best logistical solutions! Optimized packaging size, stackable with most common stacking containers, suitable for GN size containers.



Contenedor isotérmico BOXER
Thermobox BOXER
Conteneur isotherme BOXER
Contenitore isothermico BOXER
Thermobox BOXER

REF.	W(mm)	OUTSIDE L(mm)	H(mm)	W(mm)	INSIDE L(mm)	H(mm)	V(litros)	€
10422	395	595	290	340	540	230	42	50,99



10418



10419

Contenedor isotérmico ALLROUND 60/40
Thermobox ALLROUND 60/40
Conteneur isotherme ALLROUND 60/40
Contenitore isothermico ALLROUND 60/40
Thermobox ALLROUND 60/40

REF.	W(mm)	OUTSIDE L(mm)	H(mm)	W(mm)	INSIDE L(mm)	H(mm)	V(litros)	€
10418	485	660	260	425	625	200	53	85,13
10419	485	685	360	425	625	300	80	92,53

Tamaño cuadrado optimizado. Con asas empotradas y tapa hermética. Para recipientes GN 2/3, pizza o pasteles.

Optimized square size. With recessed grips, tight fitting lid. For containers GN 2/3, pizza or cakes.



Contenedor isotérmico pizza BOXER
Thermobox pizza BOXER
Conteneur isotherme pizza BOXER
Contenitore isothermico pizza BOXER
Thermobox pizza BOXER

REF.	W(mm)	OUTSIDE L(mm)	H(mm)	W(mm)	INSIDE L(mm)	H(mm)	V(litros)	€
10421	400	415	265	350	365	210	27	48,15



Contenedor isotérmico SHOPPING
Thermobox SHOPPING
Conteneur isotherme SHOPPING
Contenitore isothermico SHOPPING
Thermobox SHOPPING

REF.	COLOR	W(mm)	OUTSIDE L(mm)	H(mm)	W(mm)	INSIDE L(mm)	H(mm)	FORMATO	V(litros)	€
10420	●	285	360	365	220	300	310	GN 1/4	20	60,93

Sala

Dining Room

SALA DINING ROOM

350-353 VAJILLA

354-369 MINIATURAS

- 354 INOX Y COBRE
- 355 INOX
- 357 MELAMINA
- 358 FREIDORAS
- 359 PAPEL ANTIGRASA
- 360 HIERRO FUNDIDO
- 362 HIERRO ESMALTADO
- 366 MADERA HAYA
- 368 VAPORERAS

370-381 SERVICIO MESA

- 370 CHAMPAGNERAS
- 374 PANERAS
- 378 VINAGRERAS
- 381 ACCESORIOS





Cristal Borosilicato / Borosilicate Glass



Servicio mesa / Vajilla
 Table Top / Tableware

Bol cristal 19
 Glass bowl 19
 Bol en verre 19
 Ciotola in vetro 19
 Glasschale 19

REF.	Ø (mm)	H (mm)	€	UE / MOQ
10788	190	45	60,34	1-6-48-192-384 / 1



Bol cristal 15
 Glass bowl 15
 Bol en verre 15
 Ciotola in vetro 15
 Glasschale 15

REF.	Ø (mm)	H (mm)	€	UE / MOQ
10789	150	40	50,97	1-6-48-192-384 / 1



Soporte taco cristal
 Glass support
 Support verre
 Supporto vetro
 Glashalter

REF.	L (mm)	H (mm)	W (mm)	€	UE / MOQ
10790	120	50	60	34,83	1-6-48-192-384 / 1



Soporte taco cristal doble
 Double glass support
 Support double verre
 Supporto vetro doppio
 Doppelte glshalterung

REF.	L (mm)	H (mm)	W (mm)	€	UE / MOQ
10791	180	50	60	38,28	1-6-48-192-384 / 1



Plato cristal L

Glass plate L
Assiette en verre L
Piatto in vetro L
Glasplatte L

REF.	L(mm)	W(mm)	€	UE / MOQ
10792	270	170	68,49	1-6-48-192-384 / 1

**Plato cristal M**

Glass plate M
Assiette en verre M
Piatto in vetro M
Glasplatte M

REF.	L(mm)	W(mm)	€	UE / MOQ
10793	120	240	56,30	1-6-48-192-384 / 1

**Plato cristal S**

Glass plate S
Assiette en verre S
Piatto in vetro S
Glasplatte S

REF.	L(mm)	W(mm)	€	UE / MOQ
10794	120	120	36,13	1-6-48-192-384 / 1

**Plato cristal postre - Petit fours**

Glass dessert plate - Petit fours
Assiette à dessert en verre - Petit fours
Piatto da dessert in vetro - Petit fours
Dessertteller aus glas - Petit fours

REF.	Ø(mm)	H(mm)	€	UE / MOQ
10795	120	85	49,16	1-6-48-192-384 / 1





Capa interior acero inoxidable.
Total seguridad para el contacto alimentario.

Stainless steel interior.
Food contact total security.

Asas de bronce.

Brass handles.



CONDUCTIVIDAD TÉRMICA

Capa exterior cobre.
Facilita la cocción gracias a que este material ayuda a crear una distribución uniforme del calor por toda la superficie.

Copper exterior.
Facilitates the cooking because this material helps to create a uniform distribution of heat on all the surface.

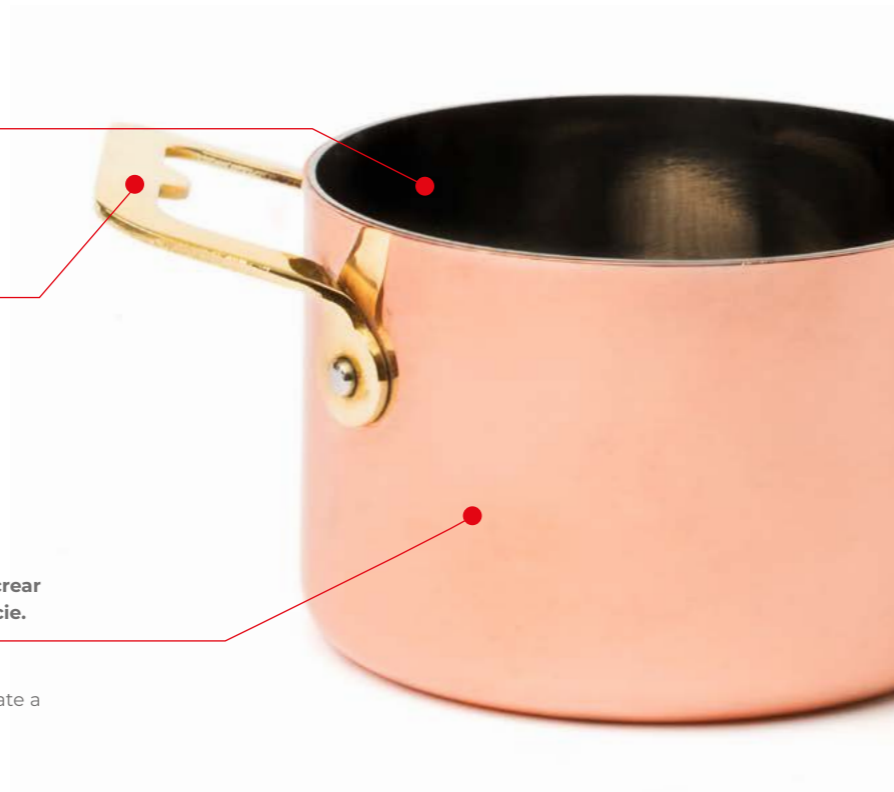

Mini sartén doble pared

Mini fry dual body
Mini poêle double paroi
Mini padella doppia parete
Copper mini pffanne dualer körper



REF.	Ø(mm)	H(mm)	€	UE / MOQ
7493	120	35	62,40	1-6-48-192-384 / 1

Mini olla doble pared

Mini casserole dual body
Mini casserole double paroi
Mini pentola doppia parete
Mini kasserole dualer körper



REF.	Ø(mm)	H(mm)	€	UE / MOQ
7495	90	60	50,55	1-6-48-192-384 / 1

Mini cazo doble pared

Mini saucepan dual body
Mini casserole double paroi
Mini casseruola doppia parete
Mini sauteuse dualer körper



REF.	Ø(mm)	H(mm)	€	UE / MOQ
7491	70	50	30,83	1-6-48-288-864 / 1

Mini paella doble pared

Mini paella dual body
Mini paella double paroi
Mini paella doppia parete
Mini paella pffanne dualer körper



REF.	Ø(mm)	H(mm)	€	UE / MOQ
7497	120	25	63,49	1-6-48-288-576 / 1



Mini sartén inox

Mini fry pan inox
Mini poêle inox
Mini padella inox
Mini pffanne edelstah



REF.	Ø(mm)	H(mm)	€	UE / MOQ
7492	100	30	14,36	1-6-48-192-384 / 1

Mini olla inox

Mini casserole inox
Mini casserole inox
Mini pentola inox
Mini kasserole edelstahl



REF.	Ø(mm)	H(mm)	€	UE / MOQ
7494	90	60	17,97	1-6-48-192-384 / 1

Mini cazo inox

Mini saucepan inox
Mini casserole inox
Mini casseruola inox
Mini sauteuse edelstahl



REF.	Ø(mm)	H(mm)	€	UE / MOQ
7490	70	50	10,92	1-6-48-288-864 / 1

Mini wok inox

Mini wok inox
Mini wok inox
Mini wok inox
Mini wok edelstahl



REF.	Ø(mm)	H(mm)	€	UE / MOQ
7496	110	50	17,24	1-6-48-192-384 / 1





Lechera snack
Snack milk pot
Pot à lait snack
Latteria snack
Snack molkeri



REF.	Ø(mm)	H(mm)	ml	€	UE / MOQ
7105	45	50	45	3,59	1-6-24-384-1536 / 6
7106	75	100	80	6,98	1-6-24-192-384 / 6

Rustidera snack
Snack lasagna pan
Plat à rôtir snack
Rostiera snack
Snack lasagneform



REF.	Ø(mm)	H(mm)	ml	€	UE / MOQ
7107	95	145	400	7,66	1-6-24-168-336 / 6

Bol triangular
Nut triangular bowl
Bol triangulaire
Ciotolina triangolare
Dreieckige schale



REF.	W(mm)	L(mm)	H(mm)	ml	€	UE / MOQ
7108	100	100	45	350	3,24	1-6-24-800-2400 / 6

Bol para olivas
Olive plat
Bol à olive
Ciotolina per olive
Olivenschale



REF.	W(mm)	L(mm)	H(mm)	ml	€	UE / MOQ
7109	72	150	20	270	5,06	1-6-24-1600-4800 / 6



Cubo snack
Snack bucket
Bol à aperitif
Vaschetta snack
Snack eimer

REF.	Ø(mm)	H(mm)	ml	€	UE / MOQ
7104	125	130	800	7,15	1-6-24-72-144 / 6
7103	85	90	320	5,06	1-6-24-192-576 / 6
7102	70	70	200	4,12	1-6-24-288-864 / 6

Mini cubo inox
Inox mini bin
Mini seau inox
Mini bidone inox
Mini behälter edelstahl



REF.	Ø(mm)	H(mm)	ml	€	UE / MOQ
7500	150	140	1500	17,45	1-6-48-144-432 / 6
7499	130	120	850	12,71	1-6-48-192-768 / 6
7498	90	90	350	6,56	1-6-48-576-1152 / 6



Mini sartén oval
Mini oval pan
Mini poêle ovale
Mini padella ovale
Mini pffanne mit griff oval



REF.	COLOR	W(mm)	L(mm)	H(mm)	€	UE / MOQ
7633	●	150	80	30	2,63	1-12-120-0-0 / 12
7634	●	150	80	30	2,63	1-12-120-0-0 / 12

Mini sartén
Mini pan
Mini poêle
Mini padella
Mini pffanne mit griff



REF.	COLOR	Ø(mm)	H(mm)	€	UE / MOQ
7632	●	120	25	3,84	1-12-108-0-0 / 12
7631	●	120	25	3,84	1-12-108-0-0 / 12

Sala / Dining room

AL-ANDALUS COLLECTION

Freidoras / Baskets

Cesto cuadrado
Square basket
Panier à frites carré
Cestino quadrato da frittura
Quadratischer korb

REF.	COLOR	W _(mm)	L _(mm)	H _(mm)	€	UE / MOQ
7482	SILVER	100	90	70	7,46	1-12-144-576-576 / 6
7483	GOLD	100	90	70	8,26	1-12-144-576-576 / 6
7484	BLACK	100	90	70	9,37	1-12-144-576-576 / 6



Cesto cuadrado

Square basket
Panier à frites carré
Cestino quadrato da frittura
Quadratischer korb

REF.	W _(mm)	L _(mm)	H _(mm)	€	UE / MOQ
7485	130	110	90	9,00	1-12-144-576-576 / 6



Mini freidora cuadrada

Mini square fryer
Mini friteuse
Mini friggitore
Quadratischer mini fittierkorb

REF.	W _(mm)	L _(mm)	H _(mm)	€	UE / MOQ
7488	110	110	50	8,27	1-12-48-192-384 / 6



Cesto redondo

Round basket
Panier à frites rond
Cestino rotondo da frittura
Runder korb

REF.	Ø _(mm)	H _(mm)	€	UE / MOQ
7480	80	85	5,75	1-12-144-576-576 / 6
7481	90	125	7,18	1-12-144-576-576 / 6



Cono chips

Cone for chips
Cornet de frites
Cono per patatine fritte
Kegel für pommes

REF.	Ø _(mm)	H _(mm)	€	UE / MOQ
7487	110	230	5,75	1-12-144-576-576 / 6



Cesto rectangular

Rectangular basket
Panier à frites rectangulaire
Cestino rettangolare per frittura
Rechteckiger korb

REF.	W _(mm)	L _(mm)	H _(mm)	€	UE / MOQ
7486	210	100	40	10,00	1-6-72-288-288 / 6



Cesto con asas

Basket with handles
Panier à frites avec des poignées
Cestino da frittura maniglie
Korb mit griffen

REF.	W _(mm)	L _(mm)	H _(mm)	€	UE / MOQ
7489	110	85	55	7,01	1-12-72-720-1440 / 6



Papel antigrasa / Greaseproof wrapping

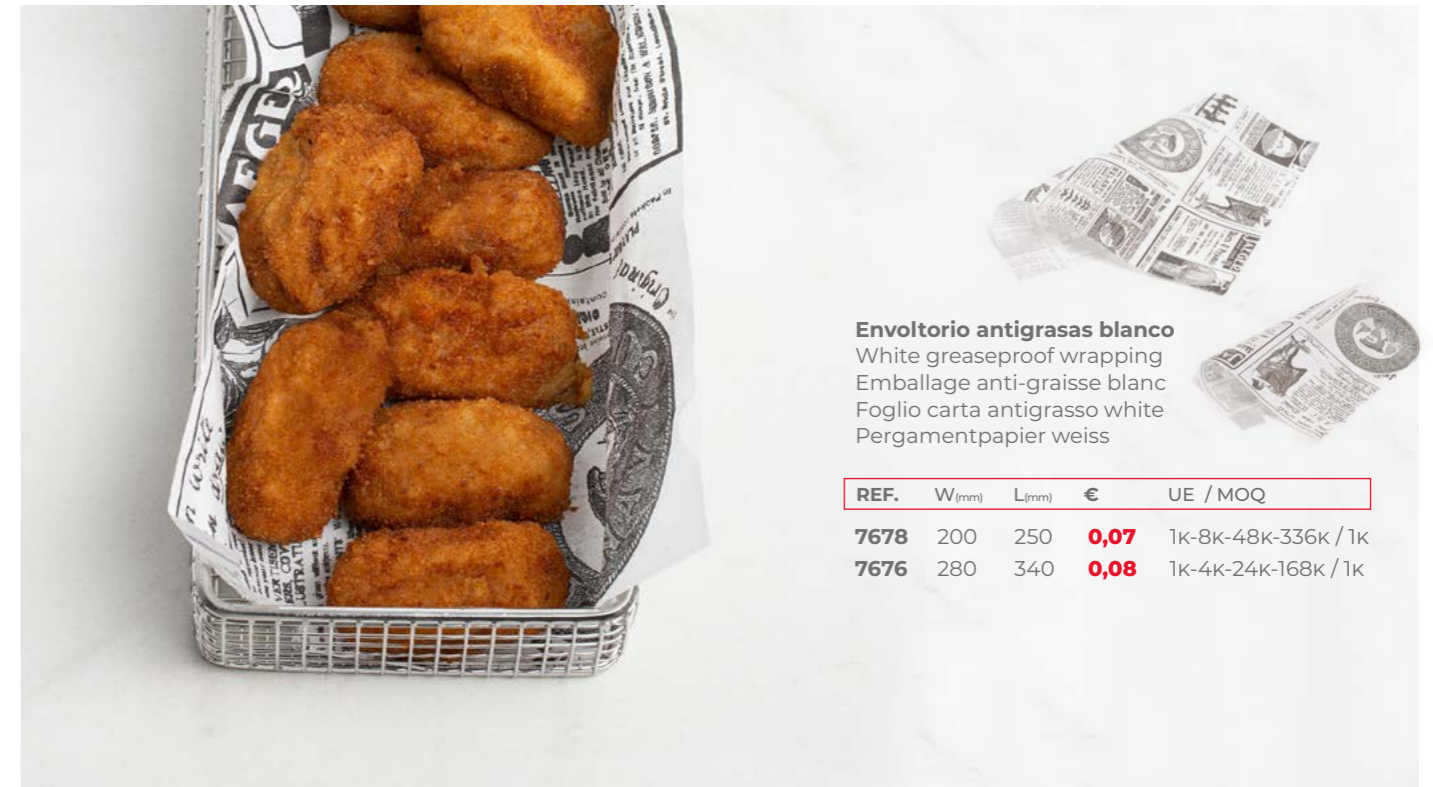

Envoltorio antigrasas blanco

White greaseproof wrapping
Emballage anti-graisse blanc
Foglio carta antigrasso white
Pergamentpapier weiss

REF.	W _(mm)	L _(mm)	€	UE / MOQ
7678	200	250	0,07	1k-8k-48k-336k / 1k
7676	280	340	0,08	1k-4k-24k-168k / 1k

Envoltorio antigrasas natural

Natural greaseproof wrapping
Emballage anti-graisse naturel
Foglio carta antigrasso natural
Pergamentpapier natur

REF.	W _(mm)	L _(mm)	€	UE / MOQ
7677	280	340	0,09	1k-4k-24k-168k / 1k



Envoltorio antigrasas times natural

Times natural greaseproof wrapping
Emballage anti-graisse times natural
Foglio carta antigrasso times natural
Pergamentpapier weiss times natural

REF.	W _(mm)	L _(mm)	€	UE / MOQ
8809	200	250	0,08	1k-8k-48k-336k / 1k



Envoltorio antigrasas negro

Black greaseproof wrapping
Emballage anti-graisse noir
Foglio carta antigrasso black
Pergamentpapier schwarz

REF.	W _(mm)	L _(mm)	€	UE / MOQ
7674	280	340	0,08	1k-4k-24k-168k / 1k



Envoltorio antigrasas rojo

Red greaseproof wrapping
Emballage anti-graisse rouge
Foglio carta antigrasso red
Pergamentpapier rot

REF.	W _(mm)	L _(mm)	€	UE / MOQ
7675	280	340	0,08	1k-4k-24k-168k / 1k



Sala / Dining room

TRADICIÓN COLLECTION



Mini sartén
Mini pan
Mini poêle en fonte
Mini padella di ghisa
Gusseisen mini pfanne

COMPATIBLE CON:

7789



REF.	Ø(mm)	H(mm)	€	UE / MOQ
7502	90	25	5,75	1-6-24-192-768 / 1



Mini sartén cuadrada
Mini square pan
Mini poêle carrée en fonte
Mini padella quadrata di ghisa
Gusseisen quadratische mini pfanne

COMPATIBLE CON:

7791



REF.	W(mm)	L(mm)	H(mm)	€	UE / MOQ
7503	140	140	30	10,88	1-6-12-96-384 / 1



Mini olla oval
Mini oval casserole
Mini cocotte ovale en fonte
Mini casseruola ovale di ghisa
Gusseisen ovale mini kasserole

COMPATIBLE CON:

7790



REF.	W(mm)	L(mm)	H(mm)	ml	€	UE / MOQ
7506	95	125	55	270	15,48	1-6-12-48-144 / 1



Mini sartén redonda 2 asas
Mini round pan 2 handles
Mini poêle ronde en fonte 2 poignets
Mini padella rotonda di ghisa 2 manici
Gusseisen runde mini pfanne m. 2 griffen

COMPATIBLE CON:

7789



REF.	Ø(mm)	H(mm)	€	UE / MOQ
7508	122	30	8,37	1-6-24-144-576 / 1

Hierro fundido / Cast Iron



Mini caldero 3 patas
Mini cooking pot 3 feet
Mini cocotte en fonte 3 pieds
Mini casseruola di ghisa 3 piedi
Gusseisen mini kasserole m. 3 füßen

COMPATIBLE CON:

7789



REF.	W(mm)	H(mm)	ml	€	UE / MOQ
7510	110	95	35	25,16	1-6-12-96-288 / 1



Mini sartén
Mini pan
Mini poêle en fonte
Mini padella di ghisa
Gusseisen mini pfanne

COMPATIBLE CON:

7789



REF.	Ø(mm)	H(mm)	€	UE / MOQ
7501	130	15	8,13	1-6-24-192-768 / 1



Mini sartén oval 2 asas
Mini oval pan 2 handles
Mini poêle ovale en fonte 2 poignets
Mini padella ovale di ghisa 2 manici
Gusseisen ovale mini pfanne m. 2 griffen

COMPATIBLE CON:

7790



REF.	W(mm)	L(mm)	H(mm)	€	UE / MOQ
7507	180	126	35	11,24	1-6-24-96-288 / 1



Mini sartén redonda 2 asas
Mini round pan 2 handle
Mini poêle ronde en fonte 2 poignets
Mini padella rotonda di ghisa 2 manici
Gusseisen runde mini pfanne m. 2 griffen

COMPATIBLE CON:

7789



REF.	Ø(mm)	H(mm)	€	UE / MOQ
7509	145	30	9,63	1-6-24-144-576 / 1

Bases de madera / Wooden board

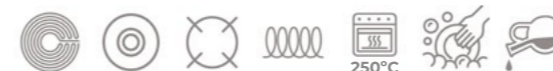

INSTRUCCIONES DE USO Y CUIDADOS

Lávalo con agua y jabón antes de su primer uso para eliminar la posible suciedad procedente de su fabricación. Después de su utilización, deje que se enfríe antes de lavarla a mano y para una mejor conservación, úntela con una capa de aceite una vez limpia. Nuestras piezas de hierro fundido no son antiadherentes.

CARE AND USE INSTRUCTIONS

Wash it with soap and water before its first use to eliminate possible dirt from its manufacture. After use, let it to cool down before hand washing it and for a better conservation, use a layer of oil once cleaned. Our cast iron griddles are not non-stick items.



Mini olla
Mini casserole
Mini cocotte en fonte
Mini casseruola di ghisa
Gusseisen mini kasserole

COMPATIBLE CON:

7789



REF.	Ø(mm)	H(mm)	ml	€	UE / MOQ
7504	140	110	60	22,99	1-6-12-48-144 / 1



Mini olla
Mini casserole
Mini cocotte en fonte
Mini casseruola di ghisa
Gusseisen mini kasserole

COMPATIBLE CON:

7789



REF.	Ø(mm)	H(mm)	ml	€	UE / MOQ
7505	110	60	35	15,48	1-6-24-96-288 / 1

Soporte madera
Wooden board
Support en bois
Table di legno
Holzplatte



ROUND



OVAL



SQUARE

REF.	MODEL	W(mm)	L(mm)	€	UE / MOQ
7789	ROUND	150	150	7,00	1-6-12-168-504 / 1
7790	OVAL	200	140	8,19	1-6-12-144-432 / 1
7791	SQUARE	160	160	7,60	1-6-12-144-432 / 1



PACKAGING BELT



Hierro esmaltado / Enamelled iron



Servicio mesa / Miniaturas
Table Top / Miniatures



Cuenco rectangular blanco / azul
Rectangular pie dish
Bol rectangulaire
Ciotola rettangolare
Eisenschälchen rechteckig

REF.	W(mm)	L(mm)	H(mm)	€	UE / MOQ
7517	145	200	40	7,11	1-12-48-480-1600 / 6
7516	130	180	35	5,95	1-12-96-768-2304 / 6
7515	120	160	30	5,50	1-12-96-864-2592 / 6

Cuenco rectangular gris
Rectangular pie dish
Bol rectangulaire
Ciotola rettangolare
Eisenschälchen rechteckig

REF.	W(mm)	L(mm)	H(mm)	€	UE / MOQ
7520	145	200	40	7,11	1-12-48-432-1296 / 6
7519	130	180	35	5,95	1-12-96-768-2304 / 6
7518	120	160	30	5,50	1-12-96-864-2592 / 6

Cuchara servir
Server spoon
Cuillère servir
Cucchiaio
Eisenlöffel

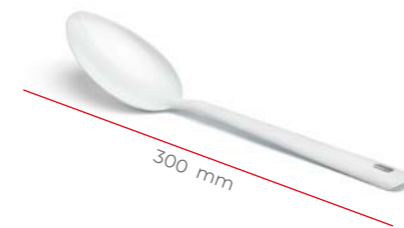

REF.	L(mm)	€	UE / MOQ
7513	300	7,31	1-10-50-1600-3200 / 10

Cuchara mesa
Table spoon
Cuillère
Cucchiaio
Eisenlöffel

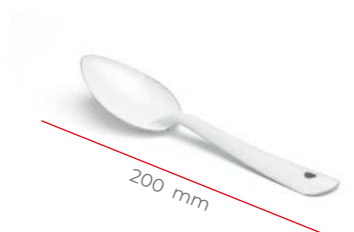

REF.	L(mm)	€	UE / MOQ
7512	200	4,31	1-12-120-3000-6000 / 12

Cuchara té
Tea spoon
Cuillère à thé
Cucchiaio
Eisenlöffel

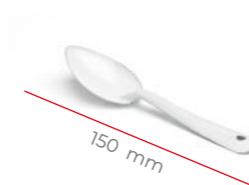

REF.	L(mm)	€	UE / MOQ
7511	150	3,53	1-12-120-3000-6000 / 12

Lechera
Creamer
Laitière
Bidone del latte
Eisenkännchen



REF.	Ø(mm)	H(mm)	ml	€	UE / MOQ
7514	70	65	190	7,90	1-12-96-384-768 / 4

Vaso para dippear

Dip cup
Mini coupe pour tremper
Bicchieri per sugo
Eisen dipschale



REF.	Ø(mm)	H(mm)	ml	€	UE / MOQ
7530	70	30	100	4,24	1-12-96-1152-2304 / 6

Vaso para dippear

Dip cup
Mini coupe pour tremper
Bicchieri per sugo
Eisen dipschale



REF.	Ø(mm)	H(mm)	ml	€	UE / MOQ
7529	60	40	90	4,03	1-12-96-1920-3840 / 6

Vaso

Tumbler
Coupe
Bicchieri
Emailliertes



REF.	Ø(mm)	H(mm)	ml	€	UE / MOQ
7527	80	90	290	6,10	1-12-96-384-768 / 6

Cazuela 2 asas

Casserole 2 handle
Cocotte 2 poignées
Casseruola 2 manici
Kasserole mit griff



REF.	Ø(mm)	H(mm)	ml	€	UE / MOQ
7525	100	50	310	7,18	1-12-96-384-768 / 6

Taza

Mug
Tasse
Tazza
Eisenbecher



REF.	Ø(mm)	H(mm)	ml	€	UE / MOQ
7521	60	45	100	4,34	1-12-96-384-1152 / 6

Taza

Mug
Tasse
Tazza
Eisenbecher



REF.	Ø(mm)	H(mm)	ml	€	UE / MOQ
7522	70	70	250	6,05	1-12-96-384-1152 / 6

Vaso alto

Taller tumbler
Coupe hauteur
Bicchieri
Emailliertes



REF.	Ø(mm)	H(mm)	ml	€	UE / MOQ
7528	80	120	400	8,57	1-12-48-192-384 / 6

Bol

Bowl
Bol
Ciotola
Eisenschale



REF.	Ø(mm)	H(mm)	ml	€	UE / MOQ
7526	140	60	510	6,61	1-12-48-576-1152 / 6



Sartén honda

Deep frying pan
Poêle profonde
Padelle
Mini-pfannen



REF.	Ø(mm)	H(mm)	€	UE / MOQ
7826	140	38	5,95	1-10-60-360-1020 / 10
7827	160	43	6,54	1-10-50-200-1000 / 10
7828	180	48	7,36	1-6-36-1008-1008 / 6
7829	200	53	8,32	1-6-42-924-924 / 6

Paellera

Paella pan
Poêle à paella
Padelle
Paella-pfannen



REF.	Ø(mm)	H(mm)	€	UE / MOQ
7792	100	20	5,20	1-10-100-300-1000 / 10
7793	120	22	5,73	1-10-100-400-1000 / 10
7794	150	24	6,63	1-10-80-320-960 / 10
7795	200	26	8,50	1-6-36-648-648 / 6

Cazuela 2 asas marrón

Brown casserole 2 handle
Mini cocotte émaillé 2 poignées brown
Casseruola ferro smaltato 2 manici brown
Emaillierte mini kasserole mit griff brown



REF.	Ø(mm)	H(mm)	ml	€	UE / MOQ
7524	100	50	310	8,10	1-12-96-384-768 / 6

Mini cazuela 2 asas marrón

Brown mini casserole 2 handle
Mini cocotte émaillé 2 poignées brown
Casseruola ferro smaltato 2 manici brown
Emaillierte mini kasserole mit griff brown



REF.	Ø(mm)	H(mm)	ml	€	UE / MOQ
7523	100	30	125	6,66	1-12-48-576-1728 / 6



Madera de haya de alta calidad.

High quality beech wood.

Acabados con aceites naturales que protegen y alargan la durabilidad de las piezas.

Finishes with natural oils that protect and prolong the pieces durability.

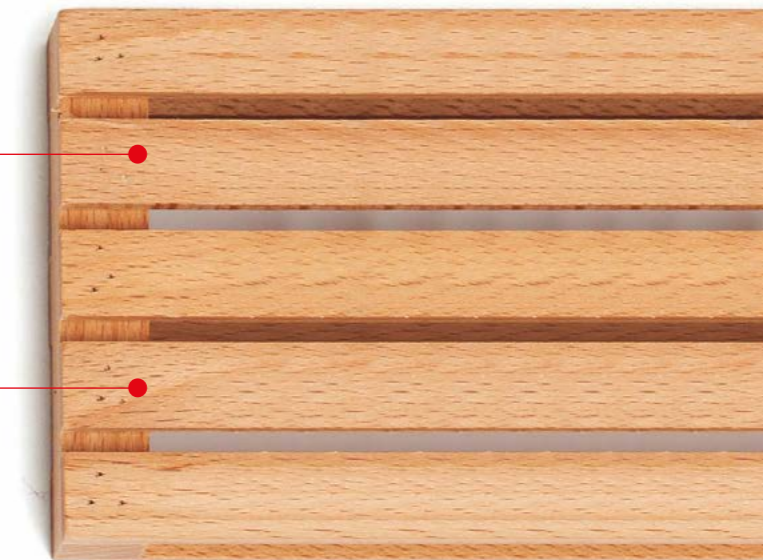

Mini palé
Mini pallet
Mini palette
Mini bancale
Mini palette



REF.	W _(mm)	L _(mm)	H _(mm)	€	UE / MOQ
7548	200	120	35	6,03	0-3-36-288-864 / 3
7547	120	80	25	3,81	0-6-36-144-432 / 6



Mini caja cuadrada
Mini square box
Mini cagette carrée en bois
Mini cassetta legno quadrata
Quadratische mini holzbox



REF.	W _(mm)	L _(mm)	H _(mm)	€	UE / MOQ
7544	170	170	70	8,62	1-0-12-48-144 / 6
7545	210	210	70	10,92	1-0-12-72-216 / 6



Mini caja rectangular
Mini rectangular wooden box
Mini cagette rectangulaire
Mini cassetta legno rettangolare
Rechteckige mini holzbox

REF.	W _(mm)	L _(mm)	H _(mm)	€	UE / MOQ
7542	150	100	50	4,51	1-0-32-128-384 / 6
7543	230	130	70	9,19	1-0-12-48-144 / 6
7546	240	160	70	11,49	1-0-12-48-144 / 6



Mini caja
Mini wooden box
Mini cagette en bois
Mini cassetta legno
Mini holzbox

REF.	W _(mm)	L _(mm)	H _(mm)	€	UE / MOQ
7539	125	80	90	10,63	1-0-24-192-384 / 6
7540	130	170	90	12,93	1-0-12-36-288 / 6



Combina las vaporeras Dim-Sum con nuestra colección de palillos KYOTO 18/10 en distintos colores.

Combine our steamers with our KYOTO 18/10 chopsticks collection in different colors.

Mango hueco para una manipulación más ligera.

Hollow handle for lighter handling.

Para saber más sobre ésta y otras colecciones Comas visita: www.comaspartners.com

In order to know more of this and other Comas collections visits: www.comaspartners.com



INOX
18/10



DIM-SUM

Vaporera bambú

Bamboo steamer
Cuiseur vapeur en bambou
Scatola tonda di bambo
Dim sum

REF.	Ø(mm)	H(mm)	€	UE / MOQ
7832	150	85	10,57	1-4-36-144-144 / 4
7831	130	85	9,34	1-4-36-144-144 / 4
7830	100	70	8,21	0-4-72-360-2520 / 4

Reposapalillo bloque

Chopsticks rest
Porte baguette
Supporto posate
Besteckhalter

REF.	COLOR	L(mm)	€	UE / MOQ
7554	SATIN	60	3,70	0-12-120-1920-5760 / 12
7555	BLACK	60	4,44	0-12-120-1920-5760 / 12

Set Palillos inox

Chopsticks set
Set baguettes
Set bacchette
Essstäbchen set

REF.	COLOR	L(mm)	€	UE / MOQ
7421	INOX	230	2,96	0-12-120-1920-5760 / 12
7422	PVD BLACK	230	3,40	0-12-120-1920-5760 / 12
7423	PVD COPPER	230	3,40	0-12-120-1920-5760 / 12
7424	PVD GOLD	230	3,40	0-12-120-1920-5760 / 12



Enfriador de botella inox
Bottle cooler inox
Glacette inox
Refrigeratore inox
Edelstahlkühle

REF.	COLOR	Ø(mm)	H(mm)	ml	€	UE / MOQ
2765	INOX	120	180	1.250	18,42	1-0-6-54-162 / 6
2787	BEIGE	120	180	1.250	20,63	1-0-6-54-162 / 6
2788	BROWN	120	180	1.250	20,63	1-0-6-54-162 / 6
2789	GREEN	120	180	1.250	20,63	1-0-6-54-162 / 6



Fondo sellado con silicona que permite contener líquido con total seguridad.

Silicone sealed bottom allows contain liquids safely.



Cubo galvanizado
Zinc ice bucket
Seau en acier galvanisé
Cubetto galvanizzato
Zinn-eiskühler

REF.	SIZE	W(mm)	L(mm)	H(mm)	ml	€	UE / MOQ
7533	XL	350	510	230	24000	22,98	1-6-48-192-384 / 1
7534	M	300	390	187	14000	14,36	1-8-64-256-512 / 1



Pie cubo champagnera 2 botellas
Champagne bucket stand 2 bottles
Pied porte-seau champagne 2 bouteilles
Colona portasecchiolo 2b
Ständer f. 2 champagnerkühler

REF.	Ø(mm)	H(mm)	€	UE / MOQ
5653	220	630	82,81	1-0-1-8-48 / 1

COMPATIBLE CON: 4967 - 5513 - 3095 (p.373)



Pie cubo champagnera 1 botella
Champagne bucket stand 1 bottle
Pied porte-seau champagne 1 b.
Colona portasecchiolo 1b.
Ständer f. 1 champagnerkühler

REF.	H(mm)	€	UE / MOQ
2786	720	30,21	1-0-1-16-80 / 1

COMPATIBLE CON: 4967 - 3095 (p.373)

Soporte cubo mesa
Wine bucket stand support
Support de table pour seau
Supporto secchio tavola
Halter für tischeimer

REF.	Ø(mm)	€	UE / MOQ
7112	200	20,36	1-0-5-25-50 / 5



COMPATIBLE CON:
4967 (p.373)



Cubitera tipo ensaladera
Ice cube bowl
Vasque
Coppa con base
Champagner kühler becken

REF.	Ø(mm)	H(mm)	ml	€	UE / MOQ
2727	345	230	10.000	41,56	1-0-1-12-12 / 1



Cubo hielo inox
Stainless steel ice bucket
Seau à glace inox
Secchiello ghiaccio
Edelstahl eiseimer

REF.	Ø(mm)	H(mm)	ml	€	UE / MOQ
3093	110	130	800	12,29	1-0-20-80-160 / 1



Cubo hielo Lux
Ice pail apple
Seau à glace lux
Secchiello ghiaccio lux
Eiseimer lux

REF.	Ø(mm)	H(mm)	ml	€	UE / MOQ
3096	120	125	1.000	8,75	1-0-20-80-60 / 1



Cubo hielo isotérmico
Double wall plain
Seau à glace isotherme
Secchiello ghiaccio isolato
Isoliert eiseimer

REF.	Ø(mm)	H(mm)	ml	€	UE / MOQ
3097	120	135	1.000	20,57	1-0-20-60-120 / 1



Cubo champagne 2 bot.
2 bottles champagne bucket
Seau champagne 2 bouteilles
Rinfrescatore champane 2b
Champagner kühler

REF.	Ø(mm)	H(mm)	ml	€	UE / MOQ
5513	240	215	6.500	56,06	1-0-4-24-48 / 1



Champagnera inox
Stainless steel champagne bucket
Seau à champagne
Secchiello champagne
Champagne eimer

REF.	Ø(mm)	H(mm)	ml	€	UE / MOQ
3095	190	190	3.500	23,85	1-0-6-18-54 / 6



Cubo champagne
Champagne bucket
Seau champagne
Rinfrescatore champane
Champagner kühler

REF.	Ø(mm)	H(mm)	ml	€	UE / MOQ
4967	200	210	3.500	16,33	1-0-6-42-126 / 6



Cubo hielo
Ice bucket
Seau à glaçons
Secchiello ghiaccio
Eisbehälter

REF.	Ø(mm)	H(mm)	ml	€	UE / MOQ
4968	140	130	1.000	5,57	1-0-20-160-320 / 10



Panera redonda kraft lavable 17
Washable round kraft breadbasket 17
Corbeille à pain ronde kraft lavable 17
Portopane rotondo kraft lavabile 17
Baschbarkraft, runder brotkorb 17



REF.	Ø(mm)	H(mm)	€	UE / MOQ
7455	170	120	8,44	1-5-50-200-400 / 5



Panera redonda kraft lavable 20
Washable round kraft breadbasket 20
Corbeille à pain ronde kraft lavable 20
Portopane rotondo kraft lavabile 20
Baschbarkraft, runder brotkorb 20



REF.	Ø(mm)	H(mm)	€	UE / MOQ
7456	200	120	10,23	1-5-50-200-400 / 5

COMPATIBLE CON: 7459 (p.377)



Panera redonda gris 17
Round grey Breadbasket 17
Corbeille à pain ronde grise 17
Portopane rotondo grigio 17
Grauer, runder brotkorb 17



REF.	Ø(mm)	H(mm)	€	UE / MOQ
7451	170	100	9,39	1-5-50-200-400 / 5



Panera oval gris
Oval grey breadbasket
Cobeille à pain ovale grise
Portopane ovale grigio
Grauer, ovaler brotkorb



REF.	W(mm)	L(mm)	H(mm)	€	UE / MOQ
7453	200	150	100	10,89	1-5-50-200-400 / 5
7454	250	180	120	11,73	1-5-50-200-400 / 5

COMPATIBLE CON: 7459 (p.377)



Panera oval kraft lavable
Washable oval kraft breadbasket
Corbeille à pain ovale kraft lavable
Portopane ovale kraft lavabile
Baschbarkraft, ovaler brotkorb



REF.	W(mm)	L(mm)	H(mm)	€	UE / MOQ
7457	250	180	130	12,53	1-5-50-200-400 / 5

COMPATIBLE CON: 7459 (p.377)

Material kraft.

Kraft Material



Panera redonda gris 20
Round grey Breadbasket 20
Corbeille à pain ronde grise 20
Portopane rotondo grigio 20
Grauer, runder brotkorb 20



REF.	Ø(mm)	H(mm)	€	UE / MOQ
7452	200	120	11,45	1-5-50-200-400 / 5

COMPATIBLE CON: 7459 (p.377)



Capas exteriores:
100% algodón
Capa interior:
35% algodón
65% poliéster

Outer layers:
100% cotton
Inner layer:
35% cotton
65% polyester

+ RIGIDEZ / RIGIDITY





Panera grissini
Breadsticks holder
Corbeille à grissini
Cestino porta grissini
Brotkorb für grissini

3
CAPAS
LAYERS + RIGIDEZ
RIGIDITY



REF.	COLOR	Ø(mm)	H(mm)	€	UE / MOQ
7779	GRIS	100	220	11,17	1-5-50-200-400 / 5
7778	BEIGE	100	220	10,34	1-5-50-200-400 / 5

Panera cuadrada 100% algodón
Square breadbasket 100% cotton
Corbeille à pain carrée
Portopane quadrato
Quadratischer brotkorb



REF.	COLOR	W(mm)	L(mm)	H(mm)	€	UE / MOQ
7598	BEIGE	120	120	140	8,19	1-5-50-200-400 / 5
7599	GRIS	120	120	140	8,48	1-5-50-200-400 / 5



MANTIENE EL CALOR
KEEPS WARM



Calentador de patatas con cerámica térmica
Potato warmer with ceramic beans
Corbeille à pain thermique
Portopane termico
Thermo-brotkorb

REF.	Ø(mm)	H(mm)	€	UE / MOQ
7458	200	130	20,67	1-5-50-200-400 / 5



Piezas de cerámica sin esmalte que mantienen el calor durante 45 minutos con sólo 30 segundos de microondas.

Glaze-free ceramic beans keep warm for 45 minutes with only 30 seconds of microwave.



Accesorio cerámica térmica
Ceramic beans warmer bag
Base thermique
Base termica
Thermo-basis

REF.	Ø(mm)	€	UE / MOQ
7459	190	14,41	1-5-50-200-400 / 5

COMPATIBLE CON / COMPATIBLE WITH: (p.375)



7456

7457

7452

7453

7454

NEW **BOROSILICATE**
+ RESISTENCIA
RESISTANCE

ANTIGOTEO

Set 2 pzas. vinagrera antigoteo
Non drip 2 pieces cruet set
Ménagère, 2 pièces
Servizio oliera, 2 pezzi
Menage, 2-teilig



REF.	ml	€	UE / MOQ
8387	260	21,50	1-0-12-0-0 / 12

NEW

CUADRADA

Set 2 pzas. vinagrera cuadrada
2 pieces square cruet set
Ménagère, 2 pièces
Servizio oliera, 2 pezzi
Menage, 2-teilig



REF.	ml	€	UE / MOQ
8393	250	7,00	1-0-24-0-0 / 24

NEW **BOROSILICATE**
+ RESISTENCIA
RESISTANCE

ANTIGOTEO

Botella antigoteo
Non drip bottle
Bouteille anti-goutte
Bottiglia antigoccia
Anti-tropf-flasche



REF.	ml	€	UE / MOQ
8388	590	11,54	1-0-24-0-0 / 24
8389	260	9,50	1-0-36-0-0 / 36

NEW

CUADRADA

Set 4 pzas. vinagrera cuadrada
4 pieces square cruet set
Ménagère, 4 pièces
Servizio oliera, 4 pezzi
Menage, 4-teilig



REF.	ml	€	UE / MOQ
8392	250	9,05	1-0-12-0-0 / 12

PARIS

Vinagrera PARIS 2 piezas
2 pieces cruet set PARIS
Ménagère 2 pièces PARIS
Oliera 2pc. mod. PARIS
2-Teilige menage PARIS



REF.	ml	€	UE / MOQ
3698	150	7,72	1-0-24-216-216 / 4

PARIS

Juego sal pimienta y mostaza
Salt, pepper and mustard set
Ménagère sel, poivre et moutarde
Sale pepe e senape mod.
Salz/pfeffer/senf-set



REF.	ml	€	UE / MOQ
3165	150	7,00	1-0-24-192-384 / 4

INOX

Vinagrera inox 2 piezas
2 pieces cruet set inox
Ménagère 2 pièces inox
Oliera 2pc. inox
2-Teilige menage inox



REF.	ml	€	UE / MOQ
3164	175	9,30	1-0-24-144-144 / 4

Blister 2 saleros
Blister 2 salt shakers
Blister 2 salières
Blister 2 salino
Blister 2 glas-salzstreuer



REF.	€	UE / MOQ
5160	2,43	1-0-100-400-400 / 10

PARIS

Vinagrera PARIS 4 piezas
4 pieces cruet set PARIS
Ménagère 4 pièces PARIS
Oliera 4pc. mod. PARIS
4-Teilige menage PARIS



REF.	ml	€	UE / MOQ
3697	150	9,46	1-0-24-96-192 / 4

PARIS

Juego sal y pimienta PARIS
Salt & pepper set PARIS
Ménagère sel et poivre PARIS
Sale e pepe mod. PARIS
Salz/pfeffer-set PARIS



REF.	€	UE / MOQ
3699	4,60	1-12-72-432-864 / 4

INOX

Vinagrera inox 4 piezas
4 pieces cruet set inox
Ménagère 4 pièces inox
Oliera 4 pc. inox
4-Teilige menage inox



REF.	ml	€	UE / MOQ
3103	175	11,31	1-0-24-96-96 / 4

NEW YORK

Vinagrera 4 piezas PVC
4 pieces PVC cruet set
Ménagère 4 pièces
Oliera 4pc.
4-Teilige Menage



REF.	ml	€	UE / MOQ
5159	150	7,23	1-0-24-96-96 / 4

Boquilla fina para verter el líquido con precisión.

Fine spout for precision pouring.

Fácil de rellenar gracias a su boquilla extraíble.

Removable spout makes for easy refilling.

Collar que recoge las gotas que puedan quedar en la boquilla y evita ensuciar la mesa.

Collar that collects any liquid left in the spout and keeps the table clean..

Cuello de vidrio glaseado que fija la boquilla.

Frosted glass collar that keeps the spout in place.

BOROSILICATE





Caja salsa
Table caddies
Cagette sauces
Cassetta per salse
Tisch organizer



REF.	W(mm)	L(mm)	H(mm)	€	UE / MOQ
7840	200	150	180	25,32	1-0-12-72-17280 / 1

Bandeja 12 rec. vinagrera PARIS
Pack 12 oil/vinegar bottle PARIS
Pack 12 bouteilles recharge PARIS
Pack 12 rec. oliera PARIS
12 teilige PARIS



REF.	ml	€	UE / MOQ
3783	150	25,37 / PACK 12	1-8 / 4

NEW

CUADRADA

Botella cuadrada
Square oil bottle
Ménagère carré
Oliera quadrata
Square menage



REF.	ml	H(mm)	€	UE / MOQ
8390	250	250	2,25	1-0-36-0-0 / 36

Bandeja 12 saleros Paris
Salt/pepper shakers PARIS
Salières PARIS
Sale PARIS
Ersalzflaschen PARIS



REF.	H(mm)	€	UE / MOQ
3905	90	13,98 / PACK 12	1-0-4-88-264 / 1

NEW

CUADRADA

Soporte 2 pzas. vinagrera cuadrada
Stand 2 pieces square cuet set
Porte huile et vinaigre
Porta olio/aceto
Essig u. Öl-stand



REF.	H(mm)	€	UE / MOQ
8394	285	4,18	1-0-24-0-0 / 24

NEW

CUADRADA

Tapón vinagrera cuadrada
Cap square bottle
Bouchon de burette
Tappo di oliera
Menage stopper



REF.	€	UE / MOQ
8391	1,51	0-12-300-0-0 / 12



Bandeja ovalada
Oval heavy try
Plateau ovale
Vassoio ovale
Tablett oval

REF.	W(mm)	L(mm)	€	UE / MOQ
7093	170	250	4,87	1-0-24-336-1344 / 6
7094	210	300	6,27	1-0-24-264-1056 / 6
7095	235	350	7,59	1-0-24-192-576 / 6
7096	270	400	9,64	1-0-24-168-504 / 6
7097	295	450	13,68	1-0-24-96-384 / 6
7098	340	500	15,32	1-0-24-96-384 / 6
7099	415	600	22,39	1-0-20-40-160 / 6



Bandeja pescado
Fish tray
Plateau poisson
Piatto pesce
Fischtablett

REF.	W(mm)	L(mm)	€	UE / MOQ
7100	250	600	19,82	1-0-20-80-400 / 6
7101	258	700	28,16	1-0-20-80-400 / 6

Sopera con base
Soup bowl
Soupière
Zuppiera
Suppenschüssel



REF.	Ø(mm)	€	UE / MOQ
9755	240	18,03	1-0-6-0-0 / 6
9756	260	19,83	1-0-6-0-0 / 6

Salsera
Gravy pot
Saucière
Salsiera
Sauciere



REF.	L(mm)	€	UE / MOQ
9757	100	7,21	1-6-60-0-0 / 6
9758	200	9,53	1-6-60-0-0 / 6
9759	350	10,53	1-6-60-0-0 / 6

Catering

CATERING CATERING

- 384-407** LES ESSENCES
 - 388 VAJILLA PORCELANA
 - 392 SOPORTES
 - 394 CUCHARAS DEGUSTACIÓN
 - 396 BANDEJAS
 - 398 ROOM SERVICE
 - 399 CUBREBANDEJAS
 - 400 BANDEJA GN 1/1
 - 402 BANDEJA LED

- 408-419** CALIU

- 420-423** BARBACOA
 - 422 ACCESORIOS BRASA





Les Essences

Les Essences 
Catering / Catering



Premio a la mejor innovación de producto.
Award for best product innovation.



Comas presenta **LES ESSENCES**, una colección pensada para vivir la experiencia de un catering exclusivo, con piezas de diseño, de líneas actuales, que se complementan entre ellas para crear una **colección única**.

Junto a profesionales del sector, hemos planteado las principales necesidades de un catering, hemos estudiado minuciosamente las formas, las medidas y las proporciones para que el conjunto sea práctico y versátil.

Cada pieza es una y múltiplo de la siguiente con lo que se consigue una perfecta disposición en sala, donde el equilibrio y la elegancia llenan el espacio, así como un fácil almacenaje tras cada pase.

*Comas presents **LES ESSENCES**, an exclusive catering collection, with trendy pieces using modern forms, that all complement each other to form a **unique collection**.*

Working along with professionals in the industry, we have identified the essential needs of catering and studied form, dimensions and proportion in minute detail to make the whole collection practical and versatile.

Each piece is at once single and a multiple of the next so that they can be arranged perfectly in any room and fill any space with balance and elegance and are easy to store after each service.

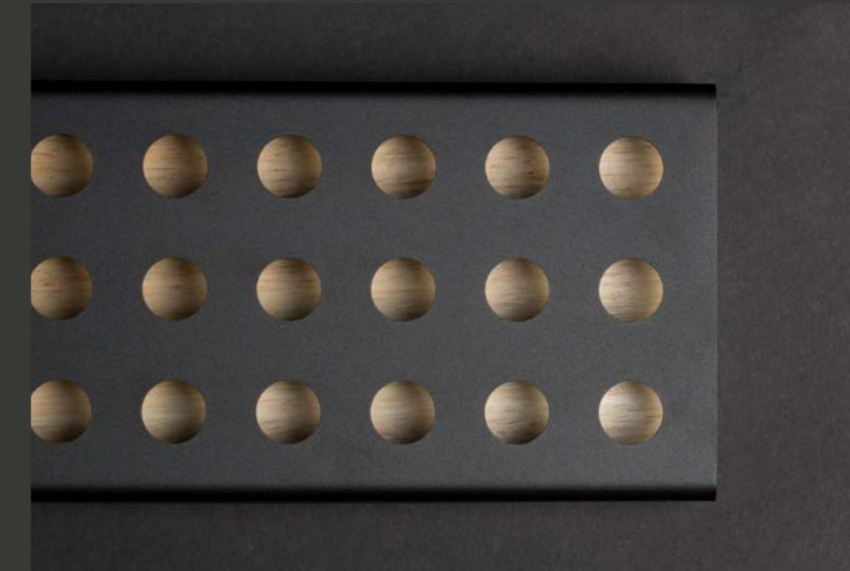

Bandejas y soportes / Trays and supports



Bandejas y soportes fabricados en aluminio para conseguir la mayor ligereza. Con formas polivalentes que optimizan las posibilidades de uso de cada una de ellas.

Trays and supports made from light materials in polyvalent forms that maximise the potential of each piece.

Porcelana
Porcelain

La calidad del proceso de fabricación de esta porcelana, cocida en 2 tiempos a más de 1.200°C, ofrece al material resistencia, suavidad al tacto e impermeabilidad de la superficie.

With two firings at 1200°C, our porcelain can withstand the demands of the most intense service. Microwaveable and oven and dishwasher safe.



Cucharas degustación
Tasting spoon

Una colección de cucharas para degustación con un diseño único son el complemento perfecto para combinar con el resto de la línea Les Essences.

Our spoons combine perfectly with the rest of the ESSENCES range to create harmony that will set off any dish to perfection.

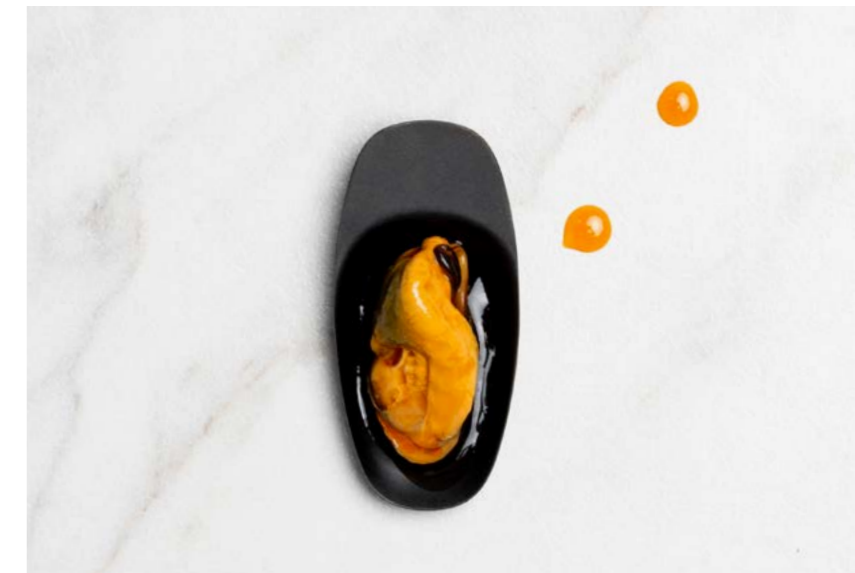

**Conoce más sobre
LES ESSENCES**



Porcelana de alta calidad fabricada en 2 tiempos de cocción a más de 1200°C, que le proporciona impermeabilidad, resistencia y suavidad al tacto.

High Quality porcelain made in 2 times firing beyond 1200°C provides impermeability, resistance and soft touch.



Vaso
Cup
Verre
Vaso
Becher



REF.	W(mm)	L(mm)	H(mm)	ml	€	UE / MOQ
7679	60	60	60	70	2,34	1-4-72-0-0 / 4

Bol
Bowl
Bol
Ciotola
Quadratische schale



REF.	W(mm)	L(mm)	H(mm)	ml	€	UE / MOQ
7670	120	120	60	400	7,09	1-4-48-0-0 / 4

Plato postre
Dessert plate
Assiette à dessert
Piatto dolce
Dessert platte



REF.	W(mm)	L(mm)	H(mm)	€	UE / MOQ
7681	120	120	18	4,15	1-4-64-0-0 / 4

Barquillo
Wafer
Barquette
Cialda
Waffel



REF.	W(mm)	L(mm)	H(mm)	€	UE / MOQ
7680	60	240	18	5,05	1-4-64-0-0 / 4

Plato llano
Dinner plate
Assiette plate
Piatto piano
Teller



REF.	W(mm)	L(mm)	H(mm)	€	UE / MOQ
7672	240	240	13	14,91	1-4-24-0-0 / 4

Bandeja simple
Simple tray
Plateau simple
Vassoio semplice
Tablett



REF.	W(mm)	L(mm)	H(mm)	€	UE / MOQ
7671	120	240	15	10,04	1-4-48-0-0 / 4

Bandeja doble
Double tray
Plateau double
Vassoio doppio
Doppelttes tablett



REF.	W(mm)	L(mm)	H(mm)	€	UE / MOQ
7673	120	480	13	16,23	1-4-24-0-0 / 4



PACKAGING
CUSTOM BOX

BAJO
DEMANDA
ON
DEMAND

Vaso trazo
Cup
Verre
Bicchiere
Becher



REF.	W(mm)	L(mm)	H(mm)	ml	€	UE / MOQ
9855	60	60	60	70	6,10	1-4-72-0-0 / 4

Bol trazo
Bowl
Bol
Ciotola
Quadratische schale



REF.	W(mm)	L(mm)	H(mm)	ml	€	UE / MOQ
9851	120	120	60	400	11,76	1-4-48-0-0 / 4

Plato postre trazo
Dessert plate
Assiette à dessert
Piatto dolce
Dessert platte



REF.	W(mm)	L(mm)	H(mm)	€	UE / MOQ
9850	120	120	18	8,82	1-4-64-0-0 / 4

Barquillo trazo
Wafer
Barquette
Vassoietto fondo
Waffel



REF.	W(mm)	L(mm)	H(mm)	€	UE / MOQ
9852	60	240	18	9,78	1-4-64-0-0 / 4

Plato llano trazo
Dinner plate
Assiette plate
Piatto piano
Teller



REF.	W(mm)	L(mm)	H(mm)	€	UE / MOQ
9849	240	240	13	21,19	1-4-24-0-0 / 4

Bandeja simple
Simple tray
Plateau simple
Vassoio semplice
Tablett

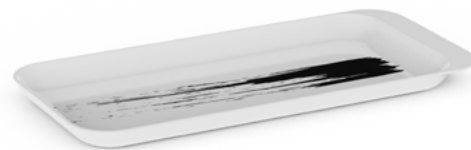

REF.	W(mm)	L(mm)	H(mm)	€	UE / MOQ
9853	120	240	15	14,53	1-4-48-0-0 / 4

Bandeja doble trazo
Double tray
Plateau double
Vassoio doppio
Doppeltes tablett

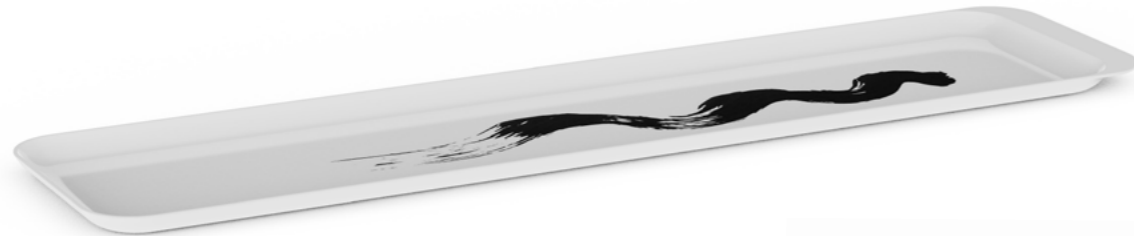

REF.	W(mm)	L(mm)	H(mm)	€	UE / MOQ
9854	120	480	13	22,31	1-4-24-0-0 / 4



PACKAGING
CUSTOM BOX



STROKE COLLECTION





Soporte conos
Cones support
Support cornets
Supporto per coni finger food
Auflage für kegel



REF.	COLOR	W _(mm)	L _(mm)	H _(mm)	€	UE / MOQ
7586	●	120	240	40	14,80	1-4-16-192-336 / 1
7595	●	120	240	40	17,76	1-4-16-192-336 / 1

Soporte piruletas
Lollipops support silver
Support sucettes silver
Supporto spiedini finger food silver
Display für lollies silver



REF.	COLOR	W _(mm)	L _(mm)	H _(mm)	€	UE / MOQ
7585	●	120	240	40	14,80	1-4-16-192-336 / 1
7594	●	120	240	40	17,76	1-4-16-192-336 / 1



Bandeja madera roble
Oak wood tray
Plateau en chêne
Vassoio legno quercia
Eichenholz tablett



Se vende por separado.
Sold separately.

REF.	W _(mm)	L _(mm)	H _(mm)	€	UE / MOQ
7587	120	240	10	12,58	1-4-16-192-336 / 1



PACKAGING
CUSTOM BOX



Soporte tacos
Tacos support
Plat support à tacos
Supporto per tacos
Auflage für tacos



REF.	COLOR	W _(mm)	L _(mm)	H _(mm)	€	UE / MOQ
7583	●	120	240	40	18,28	1-4-16-192-336 / 1
7592	●	120	240	40	20,72	1-4-16-192-336 / 1

Soporte brocheta
Skewers support
Support brochette
Supporto per spiedini lunghi
Display für spiese



REF.	COLOR	W _(mm)	L _(mm)	H _(mm)	€	UE / MOQ
7584	●	60	240	30	11,84	1-4-16-192-336 / 1
7593	●	60	240	30	14,80	1-4-16-192-336 / 1



PACKAGING
CUSTOM BOX

Diseño especialmente pensado para la degustación de aperitivos rápidos durante un catering.

Designed specially to tasting snacks during a catering.



Cuchara degustación pala
Spade tasting spoon
Cullière dégustation pelle
Cucchiaio degustazione paletta
Probierspaten m/löchern



REF.	COLOR	L(mm)	€	UE / MOQ
7568	PEFORADA VINTAGE	75	2,89	0-12-120-3960-15840 / 12
7569	VINTAGE	75	2,74	0-12-120-3960-15840 / 12
7570	VINTAGE PVD INTENSE GOLD	75	5,79	0-12-120-3960-15840 / 12
7571	VINTAGE PVD PURE CARBON	75	5,79	0-12-120-3960-15840 / 12

Cuchara degustación mango
Handle tasting spoon
Cullière dégustation pelle
Cucchiaio degustazione vanga
Probierspaten m/löchern



REF.	COLOR	L(mm)	€	UE / MOQ
7564	PEFORADA VINTAGE	120	3,35	0-12-120-3960-15840 / 12
7565	VINTAGE	120	3,20	0-12-120-3960-15840 / 12
7566	VINTAGE PVD INTENSE GOLD	120	6,24	0-12-120-3960-15840 / 12
7567	VINTAGE PVD PURE CARBON	120	6,24	0-12-120-3960-15840 / 12

Cuchara degustación espátula
Spatula tasting spoon
Cullière dégustation spatule
Cucchiaio degustazione spatola
Probierspachtel, m/löchern



REF.	COLOR	L(mm)	€	UE / MOQ
7572	PEFORADA VINTAGE	71	3,05	0-12-120-3960-15840 / 12
7573	VINTAGE	71	2,89	0-12-120-3960-15840 / 12
7574	VINTAGE PVD INTENSE GOLD	71	5,94	0-12-120-3960-15840 / 12
7575	VINTAGE PVD PURE CARBON	71	5,94	0-12-120-3960-15840 / 12

Cuchara degustación plana
Flat Tasting spoon
Cullière dégustation plat
Cucchiaio degustazione liscia
Flacher probierlöffel



REF.	COLOR	L(mm)	€	UE / MOQ
7576	VINTAGE	85	2,59	0-12-120-3960-15840 / 12
7577	VINTAGE PVD INTENSE GOLD	85	5,64	0-12-120-3960-15840 / 12
7578	VINTAGE PVD PURE CARBON	85	5,64	0-12-120-3960-15840 / 12



Bandeja rectangular pequeña
Catering tray
Plateau de présentation
Vassoio catering
Catering tablett



COLOR:
SOFT ARGENTO



COLOR:
PURE CARBON

REF.	COLOR	W(mm)	L(mm)	H(mm)	€	UE / MOQ
7579	●	150	270	69	22,20	1-4-16-0-0 / 1
7588	●	150	270	69	23,02	1-4-16-0-0 / 1

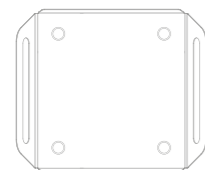

Bandeja cuadrada
Catering tray
Plateau de présentation
Vassoio catering
Catering tablett



COLOR:
SOFT ARGENTO



COLOR:
PURE CARBON

REF.	COLOR	W(mm)	L(mm)	H(mm)	€	UE / MOQ
7581	●	285	270	69	31,08	1-4-16-0-0 / 1
7590	●	285	270	69	31,07	1-4-16-0-0 / 1



Asas y barandas oblicuas para facilitar el apilado.

Oblique handles and handrails facilitates easy stacking.



Pequeña elevación de 5mm que evita que la base de la bandeja se apoye directamente en la mesa y lo hace visualmente más ligero.

Small elevation of 5mm avoids direct contact with the table and makes it visually lighter.



Bandeja rectangular estrecha
Catering tray
Plateau de présentation
Vassoio catering
Catering tablett



COLOR:
SOFT ARGENTO



COLOR:
PURE CARBON

REF.	COLOR	W(mm)	L(mm)	H(mm)	€	UE / MOQ
7580	●	150	525	96	28,12	1-4-16-0-0 / 1
7589	●	150	525	96	28,65	1-4-16-0-0 / 1



Bandeja rectangular grande
Catering tray
Plateau de présentation
Vassoio catering
Catering tablett



COLOR:
SOFT ARGENTO



COLOR:
PURE CARBON

REF.	COLOR	W(mm)	L(mm)	H(mm)	€	UE / MOQ
7582	●	285	525	96	47,06	1-4-16-0-0 / 1
7591	●	285	525	96	47,85	1-4-16-0-0 / 1



PACKAGING
CUSTOM BOX



Cubrebandeja silicona
Silicon tray cover
Couvercle plateau silicone
Coperchio vassoio in silicone
Tablett mit silikonbeschichtung



REF.	W (mm)	L (mm)	Para ref. / For ref.	€	UE / MOQ
7438	145	265	7579 - 7588	3,85	1-4-16-0-0 / 4
7439	145	520	7580 - 7589	7,20	1-4-16-0-0 / 4
7440	280	265	7581 - 7590	7,20	1-4-16-0-0 / 4
7441	280	520	7582 - 7591	13,19	1-4-16-0-0 / 4



Bandeja Room service
Room service tray
Plateau à servir
Vassoio servizio in camera
Zimmerservice tablett



COLOR:
PURE CARBON

REF.	COLOR	W (mm)	L (mm)	H (mm)	€	UE / MOQ
7930	●	385	520	69	67,55	1-4-16-0-0 / 1



Cubrebandeja corcho rectangular
Cork tray cover
Couvre plateau en liège
Coperchio per vassoio in sughero
Kork-auflage für tablett



REF.	W (mm)	L (mm)	Para ref. / For ref.	€	UE / MOQ
7845	145	265	7579 - 7588	4,45	1-4-16-0-0 / 4
7846	145	520	7580 - 7589	8,65	1-4-16-0-0 / 4
7847	280	265	7581 - 7590	8,43	1-4-16-0-0 / 4
7848	280	520	7582 - 7591	16,75	1-4-16-0-0 / 4
7931	380	515	7930	26,50	1-4-16-32-160 / 4



GN 1/1



NEW



**Conoce la
bandeja
GN 1/1**

Les Essences
Bandeja GN 1/1 / Tray Cover



325 mm

530 mm



Apilable para un mejor almacenaje.
Stackable for easy storage.

Grueso de 1,5mm para una mayor resistencia.

1.5mm thick for extra strength.

Ala externa que permite almacenar las bandejas en los trolley.

External wing for storing trays on trolleys.

Su ancho de 325 mm encaja tanto en las guías de los hornos industriales como en las cajas de transporte GN.

Its 325 mm width fits both industrial oven rails and GN transport boxes.

Aluminio ligero, facilita el transporte y soporta hornados de hasta 250 °C

Lightweight aluminium, easy to transport and withstands baking temperatures up to 250°C.

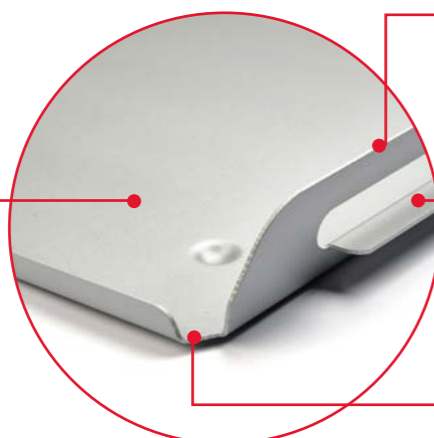

Adaptable a cajas de transporte con guías.
Adaptable to transport boxes with guides.



Adaptable a hornos industriales y carros GN.
Adaptable to industrial ovens and GN trolleys.

NEW

Bandeja GN 1/1
Tray GN 1/1
Plateau silver GN 1/1
Vassoio silver GN 1/1
Silver tablett GN 1/1

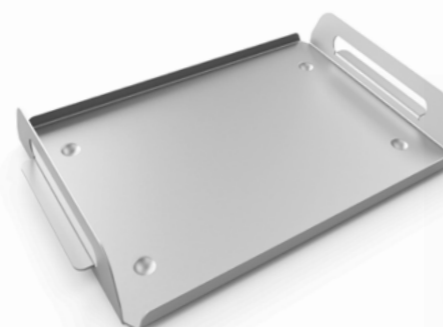

COLOR:
SILVER



COLOR:
PURE CARBON

REF.	COLOR	W(mm)	L(mm)	H(mm)	€	UE / MOQ
9991	●	325	530	54	43,10	1-4-16-0-0 / 4
9992	●	325	530	54	43,10	1-4-16-0-0 / 4

NEW

Cubrebandeja silicona GN 1/1
Silicon tray cover GN 1/1
Couvercle plateau silicone GN 1/1
Coperchio vassoio in silicone GN 1/1
Tablett mit silikonbeschichtung GN 1/1

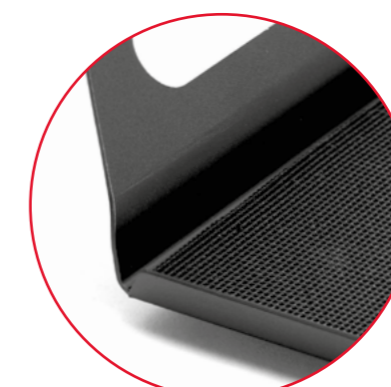

REF.	W(mm)	L(mm)	€	UE / MOQ
10785	325	530	10,30	1-4-16-0-0 / 4

LED LIGHT TRAY



Led Light Tray

Adaptable a bandeja GN 1/1
Compatible with GN 1/1



NEW

Base Led GN 1/1
Led board tray GN 1/1
Support led plateau GN 1/1
Supporto led per teglie GN 1/1
GN 1/1 tablett led

REF.	W(mm)	L(mm)	€	UE / MOQ
10784	325	530	151,26	1-4-16-0-0 / 4



Lámina de metacrilato protectora.
Apto para contacto alimentario.

Protective methacrylate sheet.
Suitable for food contact.

Lámina personalizable para cualquier emplato.

Customisable film for any dish.

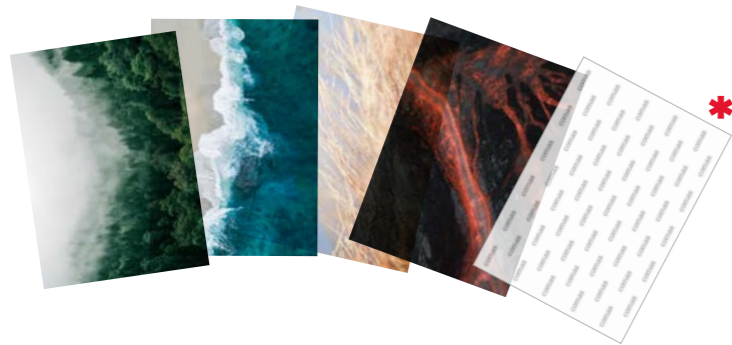
Lámina acetato personalizable
Customisable acetate film
Film acétate personnalisable
Pellicola di acetato personalizzabile
Individuell gestaltbare Acetatfolie

REF.	W(mm)	L(mm)	MODELO	€	MOQ
10786	297	420	AGUA	8,40	4
10799	297	420	FUEGO	8,40	4
10800	297	420	TIERRA	8,40	4
10801	297	420	AIRE	8,40	4
*	297	420	PERSONALIZADO	8,40	4

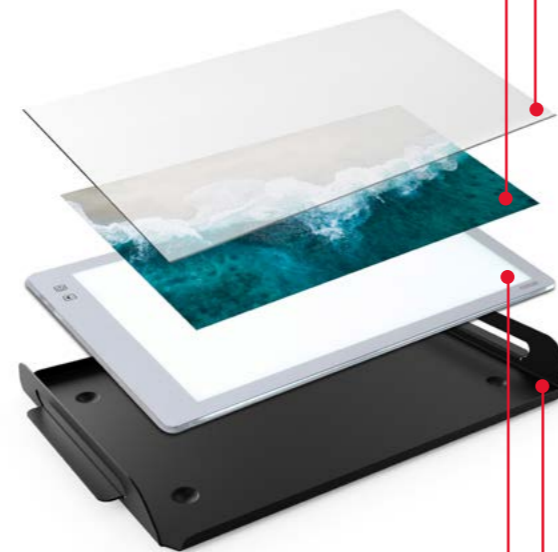

Base LED GN 1/1.

Led tray GN 1/1.

Bandeja GN 1/1 Les Essences.

Tray GN 1/1 Les Essences.



Lámina metacrilato protector.
Methacrylate protective sheet
Feuille protectrice méthacrylate
Foglio protettivo in metacrilato
Methacrylat schutzblatt



REF.	W(mm)	L(mm)	€	MOQ
10808	325	530	18,07	4

Les Essences

Bandeja iluminación Led / Led Light Tray





Botón táctil de apagado y encendido.
Touch button for power on/off.

Luz regulable en 3 intensidades.
Light adjustable in 3 intensities.

25% 60% 100%

Batería recargable por USB.
USB rechargeable battery.

Tiempo de carga: 3,5h
Charge Duration: 3,5h

4h
de duración
endurance

No sumergible. Lavable con paño húmedo.
Non-submersible. Washable with a damp cloth.

Patas de silicona para una mayor fijación en la superficie.
Silicone feet for a better fixation on the surface.

Apostamos por un concepto de desarrollo de producto propio. Tenemos muy presente la necesidad de nuestros clientes de encontrar un producto personalizable con un ciclo de vida prolongado, que se pueda adaptar a sus necesidades presentes pero también futuras. Nuestra filosofía se basa en 6 ideas clave, para ofrecer soluciones globales, escalables, atractivas y combinables.

The COMAS way is to design our own products. We are very clear that our customers are looking for customisable products with a long useful life, that can meet their current – but also future – needs. Our philosophy has six key principles, to provide complete, scalable, attractive and combinable solutions.

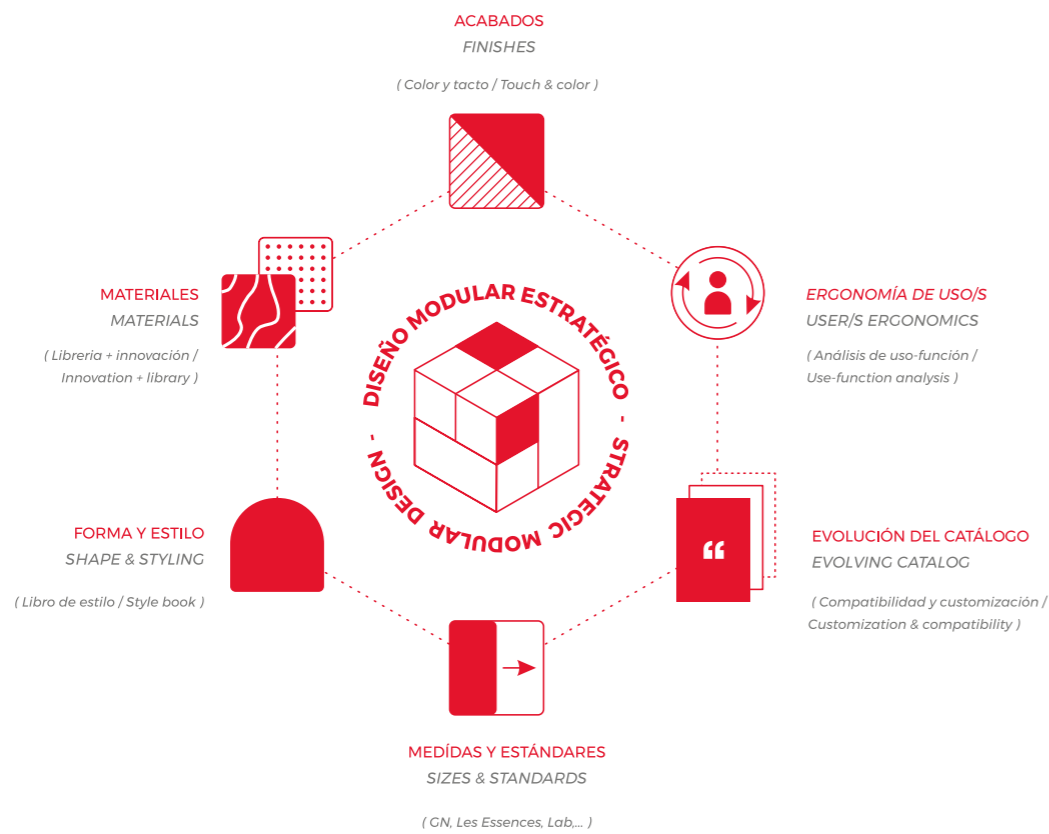



CALIU & comas

Hemos unido fuerzas con bahigüell, agencia de diseño de producto, que cuenta con una amplia experiencia en el sector gastronómico. Aportando nuestra experiencia como fabricantes para trabajar juntos en la creación de nuevos productos gastronómicos modernos, atemporales y funcionales.

Creemos firmemente que una colaboración como esta crea una sinergia entre ambas compañías, brindando a los clientes productos innovadores que harán que su uso regular sea más fácil y placentero.

We have joined forces with bahigüell, a product design agency with extensive experience in the gastronomic sector. We bring our experience as manufacturers to work together in the creation of new modern, timeless and functional gastronomic products.

We firmly believe that a collaboration like this creates a synergy between both companies, providing customers with innovative products that will make their regular use easier and more enjoyable.



Discover
CALIU's
World

Caliu
BBQ / BBQ

Caliu es una marca de conceptos gastronómicos diseñados para crear experiencias únicas.

Caliu es un conjunto de artículos pensado para el entorno profesional actual. Fácil de usar, versátil y robusta, con un equilibrio perfecto entre estética, funcionalidad y practicidad.

Caliu is a fine dining brand designed to create unique experiences.

Caliu is a set of devices designed for today's professional environment. Easy to use, versatile and robust, with a perfect balance between aesthetics, functionality and practicality.



PREMIOS DELTA



PREMIOS CACTUS

InnoForum

PREMIOS
INNOFÖRUM

Los mejores restaurantes y Chefs han confiado en CALIU / The best restaurants and Chefs have trusted in CALIU

 EL CELLER DE CAN ROCA

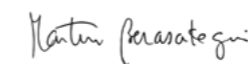

 Disfrutar
Restaurante · BARCELONA

JUBANY

calenric

PACO PÉREZ
MIRAMAR
LLANÇÀ, 1939



SEMPRONIANA

 dos pebrots

Carles Abellán



Discover
Caliu's
World

MUNDO CALIU

La colección Caliu se compone de tres áreas: barbacoas, accesorios y menaje de mesa. Queremos acompañarte en cualquier espacio gastronómico con nuestras barbacoas y su extensa gama de accesorios, presentando la brasa en la mesa de forma óptima y elegante.

¡Bienvenido/as al mundo de caliu!

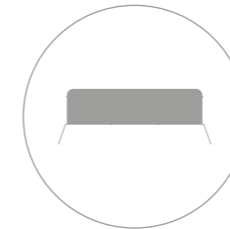

Barbacoas / Barbecues

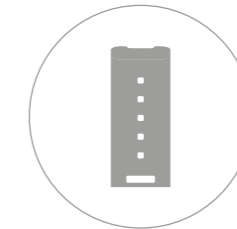

Accesorios / Accessories

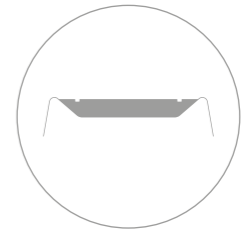

Sobremesa / Tableware

CALIU ES PERFECTA

PARA TODOS

Las barbacoas Caliu son ideales para cualquier profesional entusiasta de la brasa.

EN TODAS PARTES

Coloca Caliu en el centro de la mesa y convierte el asado en una experiencia divertida e interactiva con la que todos los comensales puedan disfrutar.

EN CUALQUIER MOMENTO

Comparte tu pasión por la brasa en cualquier época del año, con Caliu siempre es temporada de barbacoa.

Fácil de usar, duradera y producida con los mejores materiales, 100% acero inoxidable, sin ensamblajes ni partes móviles, mantiene un equilibrio perfecto.

CALIU IS PERFECT

FOR EVERYONE

Caliu barbecues are ideal for any professional barbecue enthusiast.

EVERYWHERE

Place Caliu in the centre of the table and turn the barbecue into a fun and interactive experience that everyone at the table can enjoy.

AT ANYTIME

Share your passion for grilling at any time of year because with Caliu is always barbecue season.

Easy to use, durable and produced with the best materials, 100% stainless steel, without assemblies or moving parts, maintains a perfect balance.





BARBACOA CALIU

Las barbacoas de sobremesa Caliu destacan por su diseño único y minimalista pero también por su versatilidad para trabajar múltiples técnicas y cociones. El embellecedor reversible te permite elegir dos alturas diferentes con las que cocinar.

CALIU BARBACUE

Caliu tabletop barbecues stand out for their unique and minimalist design and their versatility to multiple cooking methods and techniques. With the convertible outer house, you may choose between two different cooking heights.

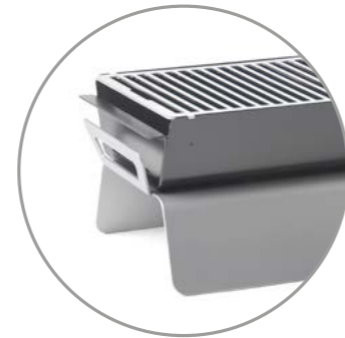

BBQ Caliu Horeca

REF.	W(mm)	L(mm)	H(mm)	€	UE / MOQ
8500	300	450	160	399,07	1-0-1-6-18 / 1



BBQ Caliu Catering

REF.	W(mm)	L(mm)	H(mm)	€	UE / MOQ
8684	300	860	160	767,87	1-0-1-6-18 / 1

CALIU ACCESORIOS

Una colección de accesorios diseñados para complementar a la perfección tu barbacoa Caliu con una variedad de usos diferentes. Las herramientas perfectas para llevar tus especialidades a la brasa al siguiente nivel.

ACCESSORIES CALIU

A collection of accessories designed to perfectly complement your Caliu barbecue with a variety of different uses. The perfect tools to take your grilled specialties to the next level.

NEW

Tapa BBQ
Bbq lid
Couvercle du bbq
Coperchio del bbq
Grilldeckel



Efecto horno, potencia los aromas.
Oven effect, enhances the aromas.



REF.	W(mm)	L(mm)	H(mm)	€	UE / MOQ
9969	260	370	140	191,31	1-0-4-24-72 / 1



Pinza BBQ
Bbq tong
Pince bbq
Molla bbq
Zange bbq



REF.	L(mm)	€	UE / MOQ
8687	260	18,18	1-0-48-5765-1728 / 1

NEW

Chimenea BBQ
Chimney Bbq
Cheminée Bbq
Grigliato Camino Bbq
Bbq Kamin



REF.	W(mm)	L(mm)	H(mm)	€	UE / MOQ
8686	80	125	300	99,97	1-0-4-64-128 / 1

CALIU EN LA MESA

Las barbacoas de sobremesa Caliu destacan por su diseño único y minimalista pero también por su versatilidad para trabajar múltiples técnicas y cocciones. El embellecedor reversible te permite elegir dos alturas diferentes con las que cocinar.

CALIU ON THE TABLE

Caliu tabletop barbecues stand out for their unique and minimalist design and their versatility to multiple cooking methods and techniques. With the convertible outer house, you may choose between two different cooking heights.

NEW

Plato brasa
 Bbq plate
 Assiette bbq
 Piatto bbq
 Grillplate

	REF.	W(mm)	L(mm)	H(mm)	€	UE / MOQ
S	8181	140	250	80	140,87	1-0-4-56-224 / 1
M	8685	140	360	80	199,94	1-0-4-56-168 / 1



Pinza automontable
 práctica y resistente para
 cocción, emplatado y
 degustación.

Self-assembly tong, handy
 and resistant for cooking,
 plate serving and tasting.



Pinza larga LOV
 Long tong LOV
 Pince LOV
 Molla LOV
 Servierzange LOV

	REF.	L(mm)	€	UE / MOQ
	7000	380	3,02	0-6-120-1080-5400 / 6

¿Diferencia entre Caliu y otras barbacoas?

La barbacoa de mesa Caliu ha sido premiada por su diseño y usabilidad. Su superficie rectangular permite preparar comidas con extrema precisión. Disponible en diferentes tamaños para satisfacer todas las necesidades.

¿Diferencia entre Caliu y parrilla abierta?

Caliu son barbacoas portátiles, versátiles, compactas, ligeras y aptas para poner encima de una mesa. Permiten hacer un sinfín de técnicas culinarias diferentes con sus accesorios diseñados y pensados para los entusiastas de la brasa.

¿Diferencia entre Caliu y hornos de brasa?

Las barbacoas Caliu son ideales para trabajar diferentes técnicas y cocciones más precisas. Además están hechas para ser vistas, lo que las hace idóneas para el showcooking frente a los comensales.

¿La barbacoa Caliu hace humo?

Sí, en toda combustión se genera humo. Se produce principalmente durante el encendido y cuando las grasas y líquidos entran en contacto con el carbón.

¿Qué carbón debo utilizar?

Puedes utilizar cualquier tipo de carbón pero te recomendamos que sea en formato briqueta y de cáscara de coco.

Difference between other barbecues & Caliu?

The Caliu table barbecue has received recognition for its design and usability. Its rectangular surface allows you to prepare meals with extreme precision. Available in different sizes to meet all needs.

Difference between open grill & Caliu?

Caliu are portable, versatile, compact, light and suitable barbecues to be placed on a table. They allow an endless number of different cooking techniques with their accessories designed and conceived for barbecue enthusiasts.

Difference between Caliu and charcoal ovens?

Caliu barbecues are ideal for working with different techniques and more precise cooking. They are also made to be seen, which makes them ideal for showcooking in front of diners.

Does the Caliu barbecue make smoke?

Yes, all combustion generates smoke. It is mainly produced during ignition and when fats and liquids come into contact with the charcoal.

Which charcoal should I use?

You can use any type of charcoal, but we recommend using briquettes and coconut shell charcoal.





Discover Caliu's World

Caliu
CARBÓN / CHARCOAL

+ PODER CALÓRICO

+ CALORIC POWER

SIN LLAMA SIN CHISPAS MENOS HUMO

FLAME-FREE NON-SPARKING LOW-SMOKE

ECOLÓGICO
ECOLOGIC

CARBÓN DE COCO

COCONUT CHARCOAL

CARBÓN

Nuestro compromiso por dar la mejor combinación entre calidad, rendimiento y facilidad de uso nos lleva a ofrecer el carbón más adecuado para usar con las barbacoas Caliu. Está hecho con cáscaras de coco naturales de plantaciones certificadas y presentado en forma de briquetas cúbicas. Perfecto por su poder calorífico estable, de larga duración, sin llama, sin chispas y poco humo.

NEW

Carbón monodosis
Single-dose charcoal
Charbon à dose unique
Carbone monodose
Einzeldosis Holzkohle



REF.	W(mm)	L(mm)	H(mm)	€	UE / MOQ
10802	80	125	300	35,25	1-0-6-64-128 /1

NEW

Carbón 5 kg
Charcoal 5 kg
Charbon 5 kg
Carbone 5 kg
Holzkohle 5 kg



REF.	PESO(kg)	€	UE / MOQ
10803	5	37,69	1-0-4-64-128 /1

CHARCOAL

We are dedicated to offering the finest quality, performance, and usability, which motivates us to want to give the best charcoal for use with Caliu grills. It is supplied as cubic briquettes and is created from natural coconut shells from verified plantations. Perfect for its stable, long-lasting, flame-free, non-sparking and low-smoke heating power.

NEW

Pastilla de encendido
Ignition tablet
Pastille d'allumage
Pastiglia di accensione
Zündungstablette



X24

REF.	W(mm)	L(mm)	H(mm)	€	UE / MOQ
10805	80	125	300	16,18	1-0-4-64-128 /1

NEW

Carbón 10 kg
Charcoal 10 kg
Charbon 10 kg
Carbone 10 kg
Holzkohle 10 kg



REF.	PESO(kg)	€	UE / MOQ
10804	10	74,45	1-0-4-64-128 /1

La chimenea Caliu es la mejor herramienta para encender el carbón de forma rápida, limpia y segura, en 20 minutos estará listo para empezar a cocinar.

In just 20 minutes, you'll be able to start cooking thanks to the Caliu Chimney's ability to ignite coal fast, cleanly, and safely.

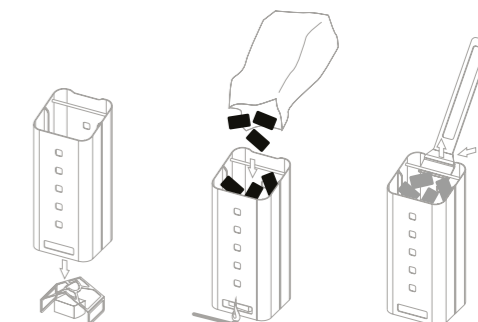



10 años de Caliu

Caliu es la marca de conceptos gastronómicos creada hace 10 años por bahigüell, una agencia de diseño de producto de Girona. 'Creemos que los detalles importan, por eso cuidamos cada fase del diseño y funcionalidad, desde el primer boceto de la fase conceptual hasta el acabado final del producto'. -bahigüell.

The gastronomic concepts brand Caliu was created 10 years ago by the product design agency bahigüell, based in Girona. 'We believe that details matter, that's why we take care of every phase of design and functionality, from the first sketch in the conceptual phase to the final product finish'. -bahigüell.



Discover
Caliu's
World

Caliu
KITS BBQ / BBQ KITS

NEW

KIT CALIU 1

Caliu BBQ + Pinza + Chimenea

REF.	€	UE / MOQ
8182	518,03	1-0-1-6-12 / 1



 **PACKAGING
CUSTOM BOX**

NEW

KIT CALIU 2

Caliu BBQ + Tapa + Pinza + Chimenea

REF.	€	UE / MOQ
8183	681,62	1-0-1-6-12 / 1



 **PACKAGING
CUSTOM BOX**



Barbacoa

Accesorios Brasa / Bbq Accessories

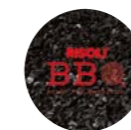

Sartén BBQ
BBQ frypan
Poêle BBQ
Padella BBQ
Pfanne BBQ

MOQ 1 UNIDAD

REF.	Ø(mm/inches)	ml	e(mm)	H(mm)	€	EAN
10058	320/11"	-	6	58	106,21	8001586010485



Paellera BBQ
Paella pan BBQ
Poêle à paella BBQ
Paellera BBQ
Paella-pfanne BBQ

MOQ 1 UNIDAD

REF.	Ø(mm/inches)	ml	e(mm)	H(mm)	€	EAN
10059	320/11"	-	6	58	106,21	8001586010492



Paellera mango inox
Inox handle saucepan
Poêle à manche inox
Paellera manico inox
Bratpfanne mit Edelstahlgriff

REF.	Ø(mm/inches)	ml	e(mm)	H(mm)	€	MOQ
10054	280/11"	150	6	48	83,14	1
10055	320/12,5"	250	6	52	94,21	1
10056	360/14,1"	350	6	58	105,92	1

Altamente resistentes al calor hasta 250°C.

Able to withstand temperatures up to 250°C.

Fabricados en cuero de alta calidad y forrados en el interior.

Manufactured in high-quality leather and lined.



Sus puños largos proporcionan una protección extra para los antebrazos.

The long cuffs provide extra protection for your forearms.

**HORNO
Y BBQ
OVEN
& BBQ**

NEW

Guantes piel para horno

Leather oven gloves
Gants de four en cuir
Cuanti da forno in pelle
Lederhandschuhe

* Estos guantes cumplen con la normativa Europea 2016/425 y EN 407:2004 nivel 3 relativo a los equipos de protección individual (EPI).

These gloves are compliant with EU Regulation 2016/425 concerning personal protective equipment (PPE) and meet EN 407:2004 Level 3, for work gloves.

REF.	L _(mm)	€	UE / MOQ
10715	460	22,48	1-0-65-130-520 / 1

NEW

Espatula para pescado

Spatula fish
Spatule poisson
Pesce spatola
Spatel fisch



NEW

Esprai aceite

Oil spray
Pulvérisateur d'huile
Spray d'olio
Ölspray



REF.	L _(mm)	€	UE / MOQ
9996	290	3,05	1-12-48-384-768 / 1

REF.	L _(ml)	€	UE / MOQ
9997	100	5,49	1-0-24-0-0 / 1

NEW

Esparto

Placemat
Sets de table
Tovaglietta
Platzmatten



NEW

Pack 6 pinchos inox

Pack 6 ss skewers inox
Pack 6 piques acier
Pack 6 spiedo acciaio
Pack 6 spiesschen stahl



REF.	Ø _(mm)	€	UE / MOQ
10716	380	8,88	1-12-48-0-0 / 1

REF.	L _(mm)	€	UE / MOQ
9993	250	3,59	1-24-96-0-0 / 1
9994	300	3,98	1-24-96-0-0 / 1



Buffet

BUFFET *BUFFET*

426-429 CAJAS MADERA

430-431 ACCESORIOS

431 JARRAS Y LECHERAS

432-435 ELEGANT

432 KIT SERVIR

435 PINZAS

436-441 PINZAS





Cajas diseñadas para contener cualquier cubeta o accesorio GN.

Designed to contain whatever pail or GN accessory.

*medidsa interiores / internal dimensions

ALTURAS DE CUBETAS GN COMPATIBLES
COMPATIBLE GN TRAY HEIGHTS

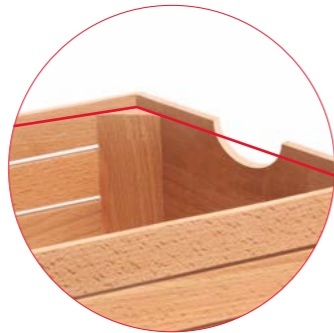
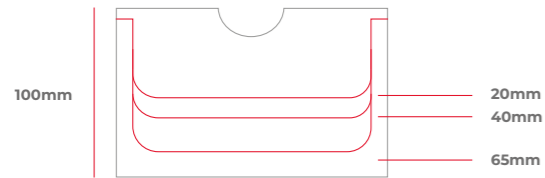

Los accesorios GN quedan encajados en el interior de las cajas, apoyados sobre los corners.

GN accessories fit inside the boxes, rested over the corners.



Caja haya
Beech wood box
Cagette en bois
Cassetta legno
Holzbox für behälter

REF.	GN	W(mm)	L(mm)	H(mm)	€	UE / MOQ
7833	1/1	325	530	100	44,65	1-0-4-16-24 / 1
7834	1/2	265	325	100	30,69	1-0-4-32-52 / 1
7835	1/3	176	325	100	25,32	1-0-6-36-72 / 1
7541	1/4	265	162	100	22,99	1-0-6-48-144 / 1
7836	2/4	162	530	100	40,15	1-0-4-16-24 / 1



Cajas madera y alzadores
Wood box and height adjusters

Soporte alzador cajas madera
Structure height adjuster
Support réhausseur
Telaio per alzata
Strukturierter höhenregulator



REF.	W(mm)	L(mm)	H(mm)	€	UE / MOQ
7838	325	530	100	12,17	1-0-4-16-48 / 1

Soporte alzador cajas madera
Structure height adjuster
Support réhausseur
Telaio per alzata
Strukturierter höhenregulator



REF.	W(mm)	L(mm)	H(mm)	€	UE / MOQ
7837	325	530	180	16,72	1-0-4-16-16 / 1

Alzador cajas madera
Height adjuster wood boxes
Réhausseur boîte en bois
Supporto per cassetta legno
Höhenregulator für Holzboxen



REF.	W(mm)	L(mm)	H(mm)	€	UE / MOQ
7839	40	40	60	4,25	0-4-64-1024-4096 / 4

Pinza servir haya punta redonda
Round head beechwood server tong
Pince à servir en bois à bout rond
Molla servire legno punta rotonda
Holzservierzange, runder kopf



Punta ondulada
Wavy tip

REF.	L(mm)	€	UE / MOQ
7549	305	4,18	1-12-72-432-864 / 6

Pinza servir haya punta fina
Slim head beechwood server tong
Pince à servir en bois à bout fin
Molla servire legno a punta
Holzservierzange, dünner kopf



Punta estriada
Ribbed tip

REF.	L(mm)	€	UE / MOQ
7550	305	4,18	1-12-72-432-864 / 6





La manera de presentar los alimentos en el buffet de un hotel puede determinar la opinión de los clientes respecto a este.

En Comas te ofrecemos una amplia gama de material profesional para vestir tu buffet. Cajas de madera para cubrir las cubetas GN, gran surtido de pinzas y piezas de servir, jarras, vajillas,...

Descubre todas las combinaciones que puedes conseguir con nuestra selección buffet.

The way of presenting food in a hotel buffet can determine the opinion of the customers about it.

At Comas we offer you a wide range of professional material to dress up your buffet. Wooden boxes to cover GN trays, a wide range of tongs and serving pieces, jugs, crockery,...

Discover all the combinations you can achieve with our buffet selection.





4 compartimentos para almacenar un servicio de mesa básico.

4 compartments to store a basic table service.

Cómodas asas laterales para un transporte fácil.

Comfortable side handles for easy carrying.



Cesta cubiertos madera
Wood cutlery dispenser
Panier à couverts en bois
Portaposate legno
Besteck-ablage aus Holz

REF.	W(mm)	L(mm)	H(mm)	€	UE / MOQ
8430	325	530	100	52,88	1-0-4-0-0 / 1



Bandeja madera portacubiertos
Wood cutlery tray
Plateau à couverts en bois
Portaposate legno
Besteckbehal aus Holz

REF.	W(mm)	L(mm)	H(mm)	€	UE / MOQ
8473	150	280	70	34,27	1-0-6-0-0 / 4

NEW



Jarra cristal tapón corcho
Glass jar with cork lid
Pichet en verre avec couvercle liège
Caraffa in vetro con coperchio in sughero
Glaskrug mit korkdeckel

REF.	Ø(mm)	H(mm)	ml	€	UE / MOQ
10806	105	178	1.200	28,63	1-0-6-0-0 / 1
10807	105	255	1.800	33,24	1-0-6-0-0 / 1



Jarra cristal
Glass bottle
Bouteille en verre
Bottigliette
Glasflasche

REF.	Ø(mm)	H(mm)	ml	€	UE / MOQ
8395	95	270	1.000	2,79	1-0-12-0-0 / 12
8396	78	200	500	1,95	1-0-24-0-0 / 24



Jarra agua
Water jug
Carafe d'eau
Caraffa d'acqua
Wasserkaraffe

REF.	Ø(mm)	H(mm)	ml	€	UE / MOQ
3030	100	145	1.250	21,09	1-0-6-0-0 / 1

Vertedor antigoteo
Anti-drip spout



Jarra policarbonato
Polycarbonate jug
Pichet en polycarbonate
Caraffa
Wasserkrug

REF.	Ø(mm)	H(mm)	ml	€	UE / MOQ
8437	110	185	1.000	12,02	1-0-12-0-0 / 12
8438	129	220	1.750	14,06	1-0-12-0-0 / 12

Buffet



Espumadera
Skimmer
Écumoire
Schiumarola
Schaumlöffel

REF.	L(mm)	€	UE / MOQ
7116	320	15,68	1-10-50-200-1000 / 10



Cuchara arroz
Rice spoon
Cuillère à riz
Cucchiaio riso
Reislöffel

REF.	L(mm)	€	UE / MOQ
6596	280	10,01	1-10-50-200-1000 / 10



Cazo salsa
Sauce ladle
Cuillère à sauce
Mestolino salsa
Soßenkelle

REF.	L(mm)	ml	€	UE / MOQ
6607	260	30	14,76	1-10-50-200-1000 / 10



Cazo sopa
Soup ladle
Louche à potage
Mestolo sopa
Suppenkelle

REF.	L(mm)	ml	€	UE / MOQ
6591	265	120	15,21	1-10-50-200-1000 / 10



Tenedor carne
Meat fork
Fourchette viande
Forchetta carne
Feischgabel

REF.	L(mm)	€	UE / MOQ
6589	300	8,16	1-10-50-200-1000 / 10



Espátula
Spatula
Spatule
Spatula
Spatel

REF.	L(mm)	€	UE / MOQ
6590	280	10,39	1-10-50-200-1000 / 10



Cazo sopa
Soup ladle
Louche à potage
Mestolo sopa
Suppenkelle

REF.	L(mm)	ml	€	UE / MOQ
6606	310	120	18,05	1-10-50-200-1000 / 10



Pala repostería
Cake server
Pelle à tarte
Pala torta
Gebäck schaufel

REF.	L(mm)	€	UE / MOQ
6595	300	9,54	1-10-50-200-1000 / 10



**PACKAGING
BLISTER**

Elegant

Kit Servir 18/10 / Serving Kit 18/10

INOX
STAINLESS
STEEL
18/10
2MM



Cuchara spaghetti
Spaghetti spoon
Cuillère à spaghetti
Cucchiaio spaguetti
Spaghetti löffel

REF.	L(mm)	€	UE / MOQ
6592	300	14,26	1-10-50-200-1000 / 10

Elegant nace de un diseño propio con la intención de dotar al buffet de unos accesorios de calidad pensados para la practicidad del usuario.

Consta de 13 piezas de servir y 4 tipos de pinzas diseñadas específicamente para cubrir las necesidades del autoservicio en catering y buffet.

Elegant was born from an own design with the intention of providing to the buffet with quality accessories intended for the user practicality.

It is composed of 13 serving pieces and 4 different tongs designed specifically to cover the self-service needs in catering and buffet.

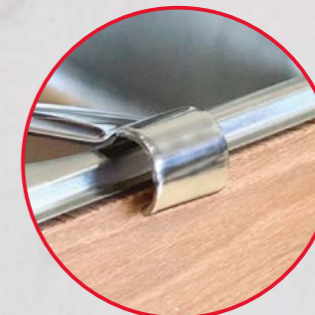

Diseño del mango especialmente pensado para colgar o apoyar en las bandejas de buffet.

Handle specially designed to be hang or supported on the buffet trays.



Bandeja reposa utensilio
Utensil rest tray
Plateau repos des ustensiles
Vassoio Riposo per l'utensile
Repository-Werkzeug tablett



REF.	W(mm)	L(mm)	H(mm)	€	UE / MOQ
7960	145	195	17	34,17	1-10-50-200-1000 / 1
7889	110	155	12	29,50	1-10-50-200-1000 / 1



Tenedor ensalada
Salad fork
Fourchette salade
Forchetta insalata
Salatgabel



REF.	L(mm)	€	UE / MOQ
6597	250	9,07	1-10-50-200-1000 / 10

Cuchara servir
Serving spoon
Cuillère à servir
Cucchiaio servir
Servierlöffel



REF.	L(mm)	€	UE / MOQ
6593	300	10,48	1-10-50-200-1000 / 10

Cuchara ensalada
Salad spoon
Cuillère salade
Cucchiaio salate
Salatlöffel



REF.	L(mm)	€	UE / MOQ
6599	250	9,07	1-10-50-200-1000 / 10

Cuchara ranurada
Slotted spoon
Cuillère à servir percée
Cucchiaio asolati
Skimmer



REF.	L(mm)	€	UE / MOQ
6594	300	10,68	1-10-50-200-1000 / 10

Cuchara arroz
Rice spoon
Cuillère à riz
Cucchiaio riso
Reislöffel



REF.	L(mm)	€	UE / MOQ
7959	355	13,44	1-10-50-200-1000 / 10

Cazo salsa
Sauce ladle
Cuillère à sauce
Mestolino salsa
Soßenkelle



REF.	L(mm)	ml	€	UE / MOQ
7958	295	3	16,36	1-10-50-200-1000 / 10

Pinza hielo
Ice tong
Pince à glaçon
Molla ghiaccio
Eiswürflzange



REF.	COLOR	L(mm)	€	UE / MOQ
6767	INOX MIRROR	190	6,15	1-10-100-600-600 / 10
6768	PVD BLACK SATIN	190	7,85	1-10-100-600-600 / 10
6769	PVD CHAMPAGNE SATIN	190	7,85	1-10-100-600-600 / 10
6770	PVD COPPER SATIN	190	7,85	1-10-100-600-600 / 10



Pinza servir
Serving tong
Pince à service
Molla arrosto
Servierzange



REF.	COLOR	L(mm)	€	UE / MOQ
6775	INOX MIRROR	240	6,78	1-10-100-600-600 / 10
6776	PVD BLACK SATIN	240	9,36	1-10-100-600-600 / 10
6777	PVD CHAMPAGNE SATIN	240	9,36	1-10-100-600-600 / 10
6778	PVD COPPER SATIN	240	9,36	1-10-100-600-600 / 10



Pinza pasteles
Cake tong
Pince à gâteau
Molla dolce
Gebäckzange



REF.	COLOR	L(mm)	€	UE / MOQ
6779	INOX MIRROR	240	6,78	1-10-100-600-600 / 10
6780	PVD BLACK SATIN	240	9,36	1-10-100-600-600 / 10
6781	PVD CHAMPAGNE SATIN	240	9,36	1-10-100-600-600 / 10
6782	PVD COPPER SATIN	240	9,36	1-10-100-600-600 / 10



Pinza Spaghetti
Spaghetti tong
Pince spaghetti
Molla spaghetti
Spahettizange



REF.	COLOR	L(mm)	€	UE / MOQ
6771	INOX MIRROR	240	6,78	1-10-100-600-600 / 10
6772	PVD BLACK SATIN	240	9,36	1-10-100-600-600 / 10
6773	PVD CHAMPAGNE SATIN	240	9,36	1-10-100-600-600 / 10
6774	PVD COPPER SATIN	240	9,36	1-10-100-600-600 / 10



PACKAGING BLISTER

Buffet



PVC aislante para una mejor sujeción.

PVC insulator for a better clamping.

Pinza servir PVC
Serving PVC tong
Pince à servir pvc
Pinze da servizio pvc
Vorlegezange pvc

REF.	L _(mm)	€	UE / MOQ
2870	240	4,42	1-24-120-480-960 / 6

Pinza multiusos PVC
Multiuse PVC tong
Pince multi-usage
Pinze multiuso
Mehrzweckzange



REF.	L _(mm)	€	UE / MOQ
2871	240	3,51	1-24-120-480-960 / 6
2872	300	4,10	1-24-120-480-960 / 6
2873	350	4,54	1-24-120-480-960 / 6

Pinza buffet PVC
Buffet PVC tong
Pince à buffet pvc
Pinze da buffet pvc
Buffetzange pvc



REF.	L _(mm)	€	UE / MOQ
2868	235	4,62	1-24-120-480-960 / 6

Pinza ensalada PVC
Salad PVC tong
Pince à salade pvc
Pinze per insalata pvc
Salatzange pvc



REF.	L _(mm)	€	UE / MOQ
2867	240	4,23	1-24-120-480-960 / 6

Pinza oval PVC
Oval PVC tong
Pince ovale pvc
Pinze ovale pvc
Ovalzange pvc



REF.	L _(mm)	€	UE / MOQ
2869	240	4,36	1-24-120-480-960 / 6

Pinza servir extra
Serving extra tong
Pince à servir extra
Pinze da servizio extra
Vorlegezange extra



REF.	L _(mm)	€	UE / MOQ
0065	240	13,83	0-10-25-200-400 / 6

Pinza repostería extra
Pastry extra tong
Pince à pâtisserie extra
Molla dolce extra
Gebäckzange extra



REF.	L _(mm)	€	UE / MOQ
0066	240	12,70	0-10-25-200-400 / 6



Pinzas / Tongs



Punta ondulada que asegura una mejor sujeción de los alimentos

Curled tip ensures a better fastening for the foods.

Pinza luxe
Luxe tong
Pince luxe
Pinze luxe
Zange luxe

REF.	L _(mm)	€	UE / MOQ
2874	240	5,84	1-24-120-480-960 / 6
2875	300	6,51	1-24-120-480-960 / 6
2876	350	7,32	1-24-120-480-960 / 6

Sistema de bloqueo para mantener la pinza cerrada.

Block system to keep closed the tong.

Pinza tijera ensalada
Salad scissor tong
Pince-ciseaux à salade
Forbice insalata
Salatschere



REF.	L _(mm)	€	UE / MOQ
3122	210	17,81	0-10-25-200-400 / 6

Pinza tijera tarta
Tart scissor tong
Pince-ciseaux à tarte
Forbice torta
Tortezange



REF.	L _(mm)	€	UE / MOQ
3124	240	20,74	0-10-25-200-400 / 6

Pinza grill
Grill tong
Pince à grill
Pinze grill
Grillzange



REF.	L _(mm)	€	UE / MOQ
2881	320	2,80	1-24-120-480-960 / 6

Pinza multiusos extra
Multiuse extra tong
Pince multi-usage extra
Pinze multiuso extra
Mehrzweckzange extra



REF.	L _(mm)	€	UE / MOQ
2877	240	2,21	1-24-120-480-960 / 6
2878	300	2,59	1-24-120-480-960 / 6
2879	350	2,83	1-24-120-480-960 / 6

Pinza tijera dulces
Cake scissor tong
Pince-ciseaux à gâteau
Forbice dolce
Kuchenzange



REF.	L _(mm)	€	UE / MOQ
3123	200	17,17	0-10-25-200-400 / 6

Pinza ensalada muelle
Salad spring tong
Pince salade
Molla salate
Salatzange



REF.	L _(mm)	€	UE / MOQ
5654	240	4,23	0-10-100-800-1600 / 6

Buffet

NEW



PVC aislante para una mejor sujeción.

PVC insulator for a better clamping.

Estas pinzas monobloc fabricadas en acero inoxidable son funcionales tanto en buffet como en cocina. Su mango de PVC en distintos colores permite controlar la contaminación cruzada de los alimentos.

These monobloc tongs in stainless steel are just as functional for service at a buffet as in the kitchen. Their distinctively coloured PVC handles makes it easy to control cross-contamination between different foods.

3
MEDIDAS
SIZES



REF.	COLOR	L(mm)	€	UE/MOQ
10677	○	250	3,60	1-10-100 / 10
10678	●	250	3,60	1-10-100 / 10
10684	●	250	3,60	1-10-100 / 10
10685	●	250	3,60	1-10-100 / 10
10686	●	250	3,60	1-10-100 / 10
10687	●	250	3,60	1-10-100 / 10
10688	●	250	3,60	1-10-100 / 10
10701	○	300	4,20	1-10-100 / 10
10702	●	300	4,20	1-10-100 / 10
10703	●	300	4,20	1-10-100 / 10
10704	●	300	4,20	1-10-100 / 10
10705	●	300	4,20	1-10-100 / 10
10706	●	300	4,20	1-10-100 / 10
10707	●	300	4,20	1-10-100 / 10
10708	○	400	4,80	1-10-60 / 10
10709	●	400	4,80	1-10-60 / 10
10710	●	400	4,80	1-10-60 / 10
10711	●	400	4,80	1-10-60 / 10
10712	●	400	4,80	1-10-60 / 10
10713	●	400	4,80	1-10-60 / 10
10714	●	400	4,80	1-10-60 / 10

Pinzas / Tongs



Pinza buffet
Buffet tong
Pince à buffet
Pinze buffet
Buffetzange



REF.	L _(mm)	€	UE / MOQ
2883	240	4,14	1-24-120-480-960 / 6

Pinza spaghetti
Spaghetti tong
Pince spaghetti
Molla spaghetti
Spagettizange



REF.	L _(mm)	€	UE / MOQ
1831	240	4,53	0-10-100-480-960 / 6

Pinza hielo muelle inox
Spring ice tong
Pince glaçon à ressort
Molla ghiaccio
Eiswürfelzange



REF.	L _(mm)	€	UE / MOQ
3476	190	2,41	1-0-102-1326-3978 / 6

Pinza hielo buffet
Buffet ice tong
Pince à glaçon buffet
Molla ghiaccio buffet
Eiswürfelzange buffet



REF.	L _(mm)	€	UE / MOQ
5276	180	2,61	0-10-100-800-2400 / 6

Pinza ensalada
Salad tong
Pince à salade
Pinze insalata
Salatzange



REF.	L _(mm)	€	UE / MOQ
2882	240	3,60	1-24-120-480-960 / 6

Pinza repostería extra
Extra cake tong
Pince à gâteau extra
Molla a dolce extra
Kuchenzange extra



REF.	L _(mm)	€	UE / MOQ
2152	240	4,56	0-10-100-600-1800 / 6

Pinza azúcar
Sugar tong
Pince à sucre
Molla succhero
Zuckerzange



REF.	L _(mm)	€	UE / MOQ
4962	125	1,36	1-0-240-1680-5040 / 6

Pinza fiambres extra
Cold meat extra tong
Pince à charcuterie extra
Molla affettati extra
Aufschnittzange extra



REF.	L _(mm)	€	UE / MOQ
3121	210	8,74	0-10-20-240-1200 / 6

Pinza pan extra
Extra bread tong
Pince à pain extra
Molla pane extra
Brotzange extra



REF.	L _(mm)	€	UE / MOQ
3120	240	7,46	0-10-25-200-400 / 6

Pinza servir
Serving tong
Pince de service
Molla arrostu
Servierzange



REF.	L _(mm)	€	UE / MOQ
2151	245	4,53	1-24-120-480-960 / 6

Pinza hielo
Ice tong
Pince à glaçon
Molla ghiaccio
Eiswürfelzange



REF.	L _(mm)	€	UE / MOQ
2153	190	2,66	0-10-100-700-2800 / 6

Pinza hielo extra
Extra ice tong
Pince à glace extra
Pinze ghiaccio extra
Eiszange extra



REF.	L _(mm)	€	UE / MOQ
2880	210	1,82	1-24-120-480-960 / 6

CALIU & comas



Pinza automontable
práctica y resistente para
cocción, emplatado y de-
gustación.

Self-assembly tong, handy
and resistant for cooking,
plate serving and tasting.



Pinza larga LOV
Long tong LOV
Pince LOV
Molla LOV
Servierzange LOV

REF.	L _(mm)	€	UE / MOQ
7000	380	3,11	0-6-120-1800-5400 / 6

BAR
BAR

444-445 SERVICIO MESA

446-451 COCTELERÍA

452-453 ACCESORIOS



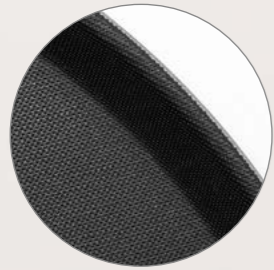

Tratamiento antideslizante:
Textura engomada que evita que los objetos se deslicen por la superficie con el movimiento.

Anti-slip:
Rubbery surface texture that keeps pieces in place while you carry them.



Fabricada en FIBERGLASS la convierte en una bandeja muy ligera, indeformable y apta para lavavajillas.

Made in FIBERGLASS, this tray is very light, unbendable and dishwasher safe.



Bandeja antideslizante
Non slip serving tray
Plateau de service antidérapant
Vassoio antiscivolo
Rutschfestes serviertablett

REF.	Ø(mm)	€	UE / MOQ
8413	360	6,14	1-0-12-0-0 / 12
8414	400	8,17	1-0-12-0-0 / 12



Bandeja FIBERGLASS antideslizante
FB round non slip serving tray
Plateau de service rond antidérapant FB
Piatto da portata rotondo antiscivolo FB
Rutschfreies rundes FB serviertablett

REF.	Ø(mm)	€	UE / MOQ
8420	360	10,42	1-0-12-0-0 / 12
8421	400	13,46	1-0-12-0-0 / 12



Bandeja FIBERGLASS antideslizante rectangular
FB rectangle non slip serving tray
Plateau de service rectangle antidérapant FB
Piatto da portata rettangolare antiscivolo FB
Rutschfreies rechteck FB serviertablett

REF.	W(mm)	L(mm)	€	UE / MOQ
8415	360	460	11,02	1-0-12-0-0 / 12
8416	380	510	15,43	1-0-12-0-0 / 12
8417	400	560	22,05	1-0-12-0-0 / 12



Bandeja FIBERGLASS antideslizante oval
FB oval non slip serving tray
Plateau de service ovale antidérapant FB
Piatto da portata ovale antiscivolo FB
Rutschfreies oval FB serviertablett

REF.	W(mm)	L(mm)	€	UE / MOQ
8418	560	680	33,67	1-0-6-0-0 / 6



Soporte bandeja
Tray support
Support de plateau
Supporto vassoio
Unterstützung serviertablett

REF.	W(mm)	L(mm)	H(mm)	€	UE / MOQ
8419	440	433	835	98,05	1-0-1-0-0 / 1



Bandeja camarero
Serving tray
Plateau barman
Vassoio bar
Serviertablett

REF.	Ø(mm)	€	UE / MOQ
4950	400	15,00	1-0-12-72-432 / 6



Vaso medidor
Peg measurer cylindrical
Verre mesureur
Misurino cocktail
Messglas

REF.	H _(mm)	ml	€	UE / MOQ
3021	100	30 / 60	2,66	1-0-24-384-1920 / 6



Coctelera con filtro
Cocktail shaker w / filter
Shaker avec filtre
Shaker per cocktail filtro
Cocktailshaker mit filter

REF.	H _(mm)	ml	€	UE / MOQ
3022	190	500	13,64	1-0-24-120-120 / 1



Cuchara coctel
Cocktail spoon
Cuillère cocktail
Cucchiaio cocktail
Cocktailöffel

REF.	L _(mm)	€	UE / MOQ
3151	290	7,02	1-12-120-1080-2160 / 12



Cuchara sangría
Sangria spoon
Cuillère sangria
Cucchiaio sangria
Sangriöffel

REF.	L _(mm)	€	UE / MOQ
2728	270	1,39	1-12-120-1920-9600 / 12



Coctelera delux
Cocktail shaker delux
Shaker delux
Shaker per cocktail delux
Cocktailshaker delux

REF.	H _(mm)	ml	€	UE / MOQ
3024	190	750	10,21	1-0-24-192-192 / 1
3023	165	500	7,81	1-0-24-120-120 / 1



Colador gusanillo
Bar strainer Mickey mouse
Passoir à cocktail mickey mouse
Colino cocktail mickey mouse
Barstrainer mickey mouse

REF.	L _(mm)	€	UE / MOQ
3027	145	3,07	1-0-24-768-2304 / 6



Soporte copas
Glass racks
Support verres à pied
Cremagliera di vetro
Glashalter

REF.	L _(mm)	€	UE / MOQ
3102	400	11,20	1-0-24-144-432 / 6
3098	600	13,23	1-0-24-144-432 / 6



Alfombra para barra estrecha

Bar mats
Dessus-de-table pour comptoir de bar
Tappetino bar
Gläserabstellmatte

REF.	W(mm)	L(mm)	€	UE / MOQ
8427	85	650	13,58	1-0-16-0-0 / 16



Alfombra para barra ancha

Bar mats
Dessus-de-table pour comptoir de bar
Tappetino bar
Gläserabstellmatte

REF.	W(mm)	L(mm)	€	UE / MOQ
8428	300	450	24,44	1-0-15-0-0 / 15



Tapón dosificador

Flow pourers
Bec verseur
Tappo versatore dosatore
Dosierausgiesser

REF.	Ø(mm)	H(mm)	€	UE / MOQ
8426	40	110	17,43 / PACK 6	1-10-100-0-0 / 60



Organizador de bar

Bar organizer
Organisateur de bar
Portacondimenti
Barcaddy

REF.	W(mm)	L(mm)	H(mm)	€	UE / MOQ
8432	148	240	110	11,32	1-0-12-0-0 / 12



Recipientes coctelería

Containers for cocktail shaker
Récipients pour cocktails
Portacondimenti
Bar-beilagenbehälte

REF.	W(mm)	L(mm)	H(mm)	€	UE / MOQ
8433	156	492	90	36,71	1-0-12-0-0 / 1





Ribeteador de vasos

Glass rimmer
Bordeuse de verres
Bordatore bicchieri
Bar-kombination salz-zuckerumranden

REF.	Ø(mm)	H(mm)	€	UE / MOQ
8431	160	72	16,89	1-0-12-0-0 / 12

Botella bar

Bar bottle with caps
Bouteille de bar
Contenitore di riserva
Dosier-vorratsbehälter, komplett

REF.	ml	Ø(mm)	H(mm)	€	UE / MOQ
8434	500	95	270	5,50	1-0-36-0-0 / 12
8435	1.000	95	330	7,20	1-0-48-0-0 / 12
8436	2.000	120	353	10,02	1-0-36-0-0 / 6

Accesorios botella bar

Bar bottle accessories
Accessoires pour bouteilles de bar
Accessori per contenitore di riserva
Zubehör für Dosier-vorratsbehälter

REF.	PACK	€	UE / MOQ
8962	PACK 4	2,72 / PACK 4	1-12-120-0-0 / 12
8963	PACK 4	4,89 / PACK 4	1-12-120-0-0 / 12



Cesta cubiertos gris

Cutlery dispenser
Récipient à couverts
Portaposate
Besteckbehälter

REF.	W(mm)	L(mm)	H(mm)	€	UE / MOQ
8429	290	525	98	11,48	1-0-12-0-0 / 12



8963

PACK 4



8962

PACK 4



POLYCARBONATE



Servilletero
Napkin dispenser
Distributeur serviettes
Portasalvietta
Serviettenhalter

REF.	W(mm)	H(mm)	€	UE / MOQ
5039	130	100	9,78	1-0-24-144-288 / 6



Pisamanteles pack 4
Tablecloth clip
Clips nappe
Molle fermatovaglia
Teilige tischdeckenklipse

REF.	€	UE / MOQ
3456	3,53 / PACK 4	1-0-100-1500-4500 / 25



Bol para olivas
Olive plat
Bol à olive
Ciotolina per olive
Olivenschale

REF.	W(mm)	L(mm)	H(mm)	ml	€	UE / MOQ
7109	72	150	20	270	5,47	1-6-24-1600-4800 / 6



Plato cambio
Bill holder
Plateau addition
Porta monette
Rechnungshalter

REF.	W(mm)	L(mm)	€	UE / MOQ
5002	170	100	4,11	1-0-100-800-1600 / 10



Pala recogemigas
Table crumber
Ramasse-miettes
Paletta per briciola
Tisch-krümelkehrer

REF.	L(mm)	€	UE / MOQ
3028	280	8,73	1-0-24-288-1152 / 6



Bol triangular
Nut triangular bowl
Bol triangulaire
Ciotolina triangolare
Dreieckige schale

REF.	W(mm)	L(mm)	H(mm)	ml	€	UE / MOQ
7108	100	100	45	350	3,44	1-6-24-800-2400 / 6

Cenicero agua
Water ashtray
Cendrier eau
Portacenere
Wasser-aschenbecher



REF.	Ø(mm)	H(mm)	€	UE / MOQ
4951	95	38	4,69	1-0-96-768-768 / 6

Jarra agua
Water jug
Carafe d'eau
Caraffa d'acqua
Wasserkaraffe



REF.	Ø(mm)	H(mm)	ml	€	UE / MOQ
3030	100	145	1.250	21,09	1-0-6-48-144 / 1

Soporte menú base
Menu card holder-flat
Porte-menu
Porta menù
Speisekartenhalte



REF.	W(mm)	€	UE / MOQ
9708	210	3,13	1-20-120-0-0 / 20

Colector de chapas 25
Cap collector
Récipient de récupération
Contenitore di raccolta
Sammelbehälter



REF.	L(mm)	€	UE / MOQ
9710	250	22,40	1-0-18-0-0 / 6

Abre botellas pared
Wall mount bottle opener
Décapsuleur mural
Levacapsule
Wandfl aschenöffner



REF.	L(mm)	€	UE / MOQ
9711	125	2,03	1-20-100-0-0 / 20

Sacacorchos
Waiter's corkscrew
Tire-bouchon de serveur
Cavatappi cameriere
Kellnermesser



REF.	L(mm)	€	UE / MOQ
8479	120	2,58	1-12-72-0-0 / 24

Cenicero abierto
Round ashtray
Cendrier
Portacenere
Offener aschenbecher



REF.	Ø(mm)	H(mm)	€	UE / MOQ
7113	100	35	3,33	1-0-90-720-1440 / 6

Soporte menú clip
Menu card holder - clip
Support numéro de table
Supporto numero tavola
Tischnummerständer



REF.	L(mm)	€	UE / MOQ
9706	200	5,73	1-6-60-0-0 / 6
9707	300	6,77	1-6-60-0-0 / 6

Placa reservado
Table tag reservado
Plaquette de table reservado
Targhetta tavola reservado
Tischaufsteller reservado



REF.	W(mm)	€	UE / MOQ
9709	190	2,14	1-25-100-0-0 / 25

- MAZOS
- GRANADA / BAGUETTE
 - CUBA / LUNA
 - MADRID / BARCELONA / MUNICH
 - VIENA / LONDON
 - BILBAO / INGLES / MALVARROSA
 - MIA / ONLINE / CHEESE
 - IBIZA / OSLO / HIDRAULIC / NICE
 - HOTEL / ALIDA / CANADA
 - SEVILLA / CHEF / NORTH



1



8



9



10



2



3



4



11



12



5



6



7



13



14

1. MAZOS Para cuchillos, cucharas y tenedores 2. CAJA 12 UNIDADES PVC Box 12 units PVC 3. BLISTER CHULETEROS Blister knives 4. BLISTER 4 PIEZAS FINGER FOOD Blister 4 units Finger Food 5. BLISTER CARTÓN COMAS Blister Comas 6. CAJA 12 UNIDADES VENTANA Box 12 units window 7. CAJA 12 UNIDADES VENTANA KRAFT Box 12 units windows kraft 8. CAJA 6 CHULETEROS MADERA Wood box 6 steak knife 9. CAJA 6 CHULETEROS KRAFT Kraft box 6 steak knife 10. CAJA 12 UNIDADES Box 12 units 11. CAJA 16 , 24 Y 30 UNIDADES COMAS Comas Box 16, 24 and 30 units 12. CAJA 16 , 24 Y 30 UNIDADES COMAS AUTOR Comas Autor Box 16, 24 and 30 units 13. CAJA DISPLAY Display box 14. ESTUCHE 24 PIEZAS MADERA 24 pieces wooden pack.



A



B



C



G



H



I



G

5570 EXPOSITOR SOBREMESA COMAS
counter display, présentoir 4 pièces, espositore da tavola, besteck-präsentations-ständer klein

H

5571 EXPOSITOR SOBREMESA CUCHILLOS
totem display stand, présentoir totem mobile, espositore totem, besteck-präsentations-ständer groß

I

5648 EXPOSITOR BANDEROLA COMAS
comas flag display stop rayon, comas espositore a bandiera, comas fahnen-besteck-display

J

5646 MUEBLE EXPOSITOR TOTEM COMAS
totem display stand, présentoir totem, mobile espositore, totem besteck-präsentations-ständer groß



J

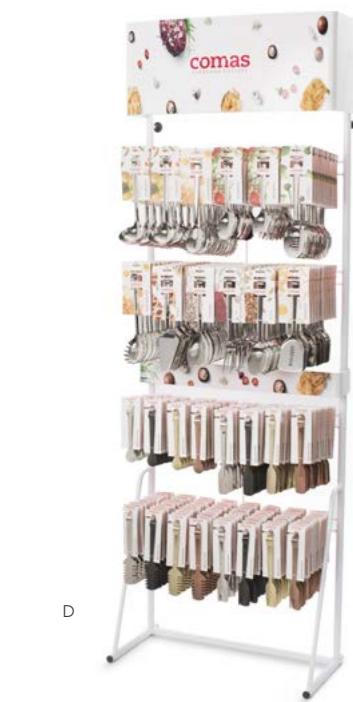

D





E



F

- A **7531** MUEBLE EXPOSITOR DOCENAS COMAS
hospitality dozen comas display stand
- B **5565** MUEBLE EXPOSITOR HOSTELERÍA
horeca stand
- C **5564** MUEBLE EXPOSITOR BLISTER LACASA
blister Lacasa stand white
- D **6792** MUEBLE EXPOSITOR MENAJE
kitchenware stand
- E **5650** MUEBLE EXPOSITOR MADERA
wood stand
- F **8377** MUEBLE EXPOSITOR COMAS GENÉRICO
comas stand

	€	× mm	∑ mm		
A	743,53 €	1200	1850	4 COLEC. 1 MASTER POR REFERENCIA	2880 PIEZAS
B	796,30 €	1280	1823	5 COLEC. 1 MASTER POR REFERENCIA	1440 PIEZAS
C	250,97 €	480	2100	3 COLEC. + 27 REFERENCIAS	764 PACKS
D	254,71 €	675	2136	4 COLEC. 1 MASTER POR REFERENCIA	2880 PIEZAS
E	787,79 €	542	1700	3 COLEC. 4 INNER POR REFERENCIA	576 PIEZAS
F	563,00 €	480	2100	3 COLEC. + 27 REFERENCIAS	764 PACKS

	€	× mm	∑ mm		
G	29,74 €	235	320	1 COLEC.	4 PIEZAS
H	52,03 €	400	330	1 COLEC.	7 PIEZAS
I	52,03 €	440	270	1 COLEC.	4 PIEZAS
J	316,71 €	301	1869	8-16 COLEC.	32-64 PIEZAS



A



B



C



D



E



F

		€	mm	mm		
A	7824 BASE MUEBLE EXPOSITOR NEGRO COMAS AUTOR comas autor display stand	675,94 €	720	1600	1 COLEC.	1 MASTER FOR REFERENCIA
A	7597 TABLERO EXPOSITOR MUEBLE MADERA COMAS AUTOR black wooden display stand comas autor	24,37 €				
B	7780 TABLERO EXPOSITOR MUEBLE MADERA LAB black wooden display stand lab	24,37 €				
C	7781 TABLERO EXPOSITOR MUEBLE MADERA KODAI black wooden display stand comas kodai	24,37 €				
D	7782 TABLERO EXPOSITOR MUEBLE MADERA SAKURA black wooden display stand sakura	24,37 €				
E	7888 TABLERO EXPOSITOR MADERA CHULETERO HQ black wooden display stand steak knives	24,37 €				
F	7561 CAJA EXPOSITOR BLISTER LACASA display box lacasa packs	43,64 €	480	240	4 COLEC.	96 PIEZAS
G	5569 EXPOSITOR SOBREMESA COMAS AUTOR table stand comas autor	29,74 €	235	320	1 COLEC.	4 PIEZAS
	5647 MUEBLE EXPOSITOR TOTEM COMAS AUTOR stand totem comas autor	316,71 €	301	1869	8-16 COLEC.	32-64 PIEZAS



G



Catering



Buffet



Room service



Sala
Dining room



Bar
Pub



Cocina
Kitchen



Logística
Logistics



Diseño propio
Designed in-house



Modular
Modular



Apto para fogón eléctrico
Suitable for Electric Cooker



Apto para horno
Suitable for Oven



Lavar a mano
Hand Wash



No fuego directo
No direct fire



Apto para congelador
Suitable for Freezing



Temperatura máxima
MÁX. 220°C
Max. temperature



Acabado brillo
Mirror finish



No apto para contacto alimentario
Food contact not safe



Apilable
Stackable



Sostenible
Sustainable



Apto para gas
Suitable for conventional Gas Cooker



Apto para microondas
Suitable for Microwave



No apto para horno
Not Suitable for Oven



Apto para lavadora
Machine Washable



Hidratar con aceite de oliva
Hydrate with Olive Oil



Apto para contacto alimentario
Food contact Safe



Acabado satin
Satin finish



Recubrimiento non-stick
Non-tick coating



Ligero
Lightweight



Apto para vitrocerámica
Suitable for Vitroceramic



Apto para inducción
Suitable for Induction Cooker



Apto para lavavajillas
Dishwasher safe



No apto para microondas
Not Suitable for Microwave



Soporta hasta 80°C
Until 80°C suport



Combinable con otros productos del catálogo
Combinable with other products in the catalog.



Antideslizante
Anti-slip



Espesor material
Thickness



Polipropileno
Polypropylene



Acero inoxidable 18/10
Stainless steel 18/10



Silicona
Silicone



Borosilicato
Borosilicate



Polietileno de alta densidad
High density polyethylene



Recubrimiento antiadherente
Quantanium
Non-stick coating Quantanium



Gastronorm



Acero inoxidable
Stainless steel



Madera de roble
Oak wood



Policarbonato
Polycarbonate



Libre de Bisfenol A
Bisphenol A free



Triple capa antiadherente
Triple non-stick coating



Libre de PFOA
Pfoa free



3 capas
3 layers



Nylon



Madera de haya
Beech wood



Hierro esmaltado
Enamelled iron



PVD color
PVD color



Fondo sistema sandwich
Sandwich bottom system

**Si tienes alguna sugerencia o simplemente quieres saludarnos,
¡No dudes en contactarnos!**

For any suggestion or just to greet us, please do not hesitate to contact us!

comaspartners@comaspartners.com

**Y si lo que quieres es estar al corriente de nuestras noticias y novedades,
únete a nuestra comunidad online o suscríbete a nuestro newsletter:**

And if you want to be aware of our news and novelties, join our online
community or subscribe to our newsletter.

newsletter@comaspartners.com

**El contenido del catálogo está sujeto a modificaciones.
Los datos técnicos son válidos salvo error tipográfico.**

Texts and images published on this catalogue may contain technical inconsistencies or
typographical errors. The information is subject to periodic changes.